



US00D873894S

(12) **United States Design Patent**
Huang

(10) **Patent No.:** **US D873,894 S**
(45) **Date of Patent:** **** Jan. 28, 2020**

- (54) **WATERPROOF CAMERA COVER**
- (71) Applicant: **Huifeng Huang**, Huizhou (CN)
- (72) Inventor: **Huifeng Huang**, Huizhou (CN)
- (**) Term: **15 Years**
- (21) Appl. No.: **29/650,612**
- (22) Filed: **Jun. 7, 2018**
- (51) **LOC (12) Cl.** **16-05**
- (52) **U.S. Cl.**
USPC **D16/237**; D16/242; D16/204
- (58) **Field of Classification Search**
USPC D16/200–220, 131, 237, 242, 239, 250,
D16/235, 130, 134, 136, 238;
D14/138 C, 240, 248, 203.1, 203.3, 203.7,
D14/218, 207; D10/104.1, 50, 65, 74,
D10/70, 118.2; D26/28, 29, 34, 51, 52,
D26/60, 61, 722; D3/260; D30/109,
D30/104, 106, 107; D22/136
CPC . G02B 7/02; G02B 7/021; G02B 7/04; G02B
7/14; G02B 7/003; G03B 17/00; G03B
17/02; G03B 17/56; G03B 17/04; G03B
17/14; G03B 17/08; G03B 15/03; G03B
15/06; H04N 5/2251; H04N 5/2252;
H04N 5/2253; H04N 5/2254; H04N 7/00;
H04N 2101/00; F16M 13/00
See application file for complete search history.

(56) **References Cited**

U.S. PATENT DOCUMENTS

- D179,631 S * 2/1957 Fassin D16/214
- D182,681 S * 4/1958 Morgenstern D12/188
- D197,887 S * 4/1964 Ward D12/187
- D199,158 S * 9/1964 Monson D16/239
- D212,650 S * 11/1968 Leman D16/202
- 3,527,437 A * 9/1970 Lippman G03B 15/03
248/205.1
- D219,405 S * 12/1970 Nemesnyik D16/235

- D234,268 S * 2/1975 Burrige D16/131
- D239,315 S * 3/1976 Satoh et al. D26/104
- D300,259 S * 3/1989 Lungstrom D12/187
- D312,318 S * 11/1990 Currie D26/46
- D317,311 S * 6/1991 Anderson D14/240
- D347,704 S * 6/1994 Thompson D26/28
- D351,243 S * 10/1994 Williams D26/28
- D365,105 S * 12/1995 Aubuchon D14/240
- D459,379 S * 6/2002 Cheng D16/204
- D472,999 S * 4/2003 Layne D26/61
- D493,239 S * 7/2004 Kneefel D26/28
- D575,424 S * 8/2008 Gebhard D26/28
- D581,070 S * 11/2008 Vanderhoek D26/28
- D582,955 S * 12/2008 Sekine D16/218

(Continued)

FOREIGN PATENT DOCUMENTS

- CN 303793760 * 8/2016
- CN 303842571 * 9/2016

Primary Examiner — T Chase Nelson

Assistant Examiner — Mary Claire Ramirez

(74) *Attorney, Agent, or Firm* — Gokalp Bayramoglu

(57) **CLAIM**

The ornamental design for a waterproof camera cover, as shown and described.

DESCRIPTION

FIG. 1 is a perspective view of a waterproof camera cover showing my new design;
 FIG. 2 is another perspective view thereof;
 FIG. 3 is a front view thereof;
 FIG. 4 is a rear view thereof;
 FIG. 5 is a top view thereof;
 FIG. 6 is a bottom view thereof;
 FIG. 7 is a left side view thereof; and,
 FIG. 8 is a right side view thereof.
 The broken lines shown in the drawings depict portions of the waterproof camera cover that form no part of the claimed design.

1 Claim, 8 Drawing Sheets

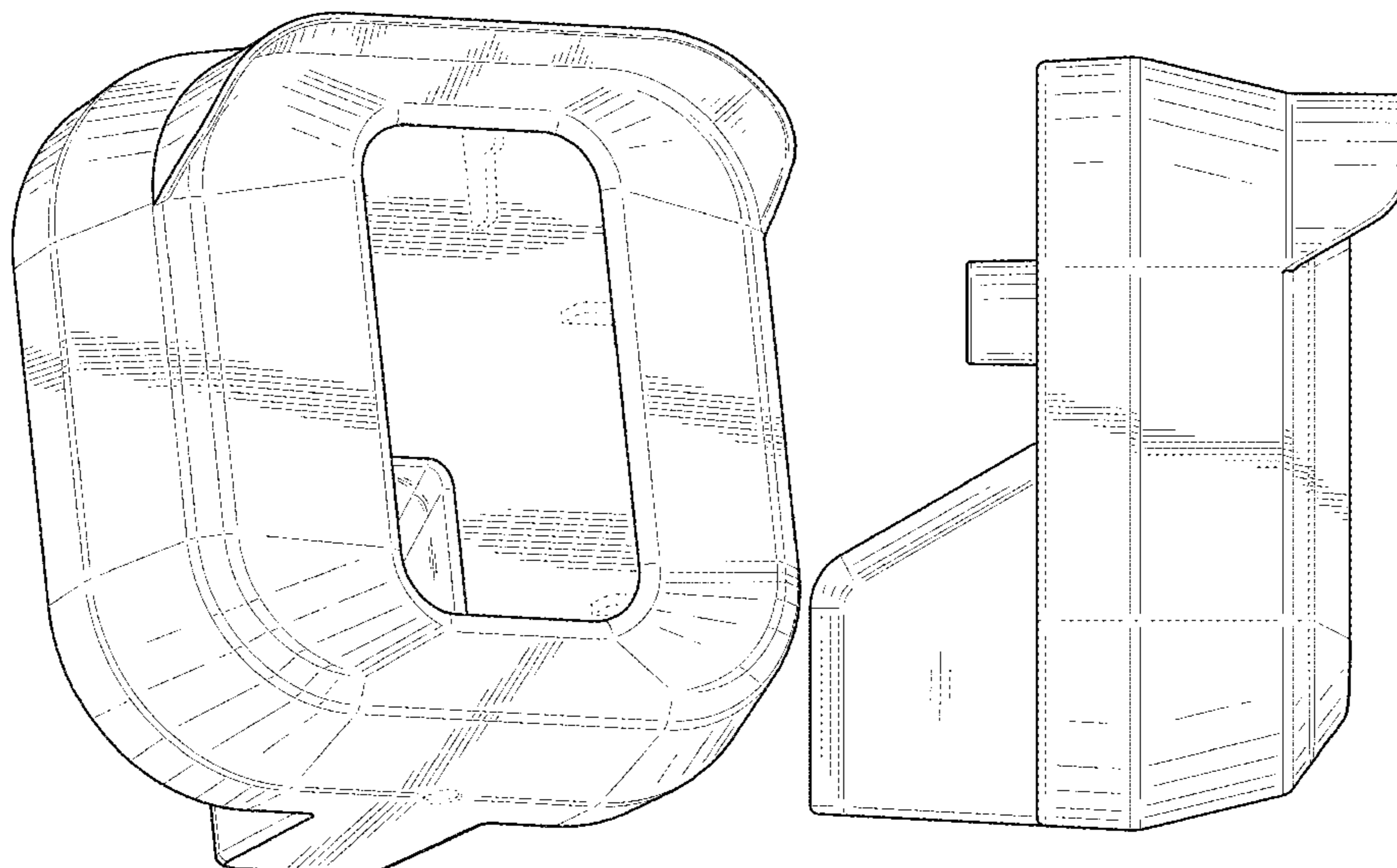

(56)

References Cited

U.S. PATENT DOCUMENTS

D624,950	S *	10/2010	Hall, Jr.	D16/237
8,616,327	B1 *	12/2013	Palacios	H04M 1/035 181/175
D707,743	S *	6/2014	Nakashima	D16/202
D724,638	S *	3/2015	Samuels	D16/200
D750,684	S *	3/2016	Katori	D16/203
D753,207	S *	4/2016	Katori	D16/203
D786,538	S *	5/2017	Morenstein	D2/857
D815,182	S *	4/2018	Sugawara	D16/235
D839,949	S *	2/2019	Arens	D16/242
D843,868	S *	3/2019	Henne	D10/98
D852,870	S *	7/2019	Medlen	D16/219
2008/0075455	A1 *	3/2008	Lin	G03B 17/56 396/534
2015/0177532	A1 *	6/2015	Evans	A45C 11/38 356/402
2016/0050397	A1 *	2/2016	Di Giamberardino	H05B 37/0227 315/149
2019/0011810	A1 *	1/2019	Dohi	G03B 17/561

* cited by examiner

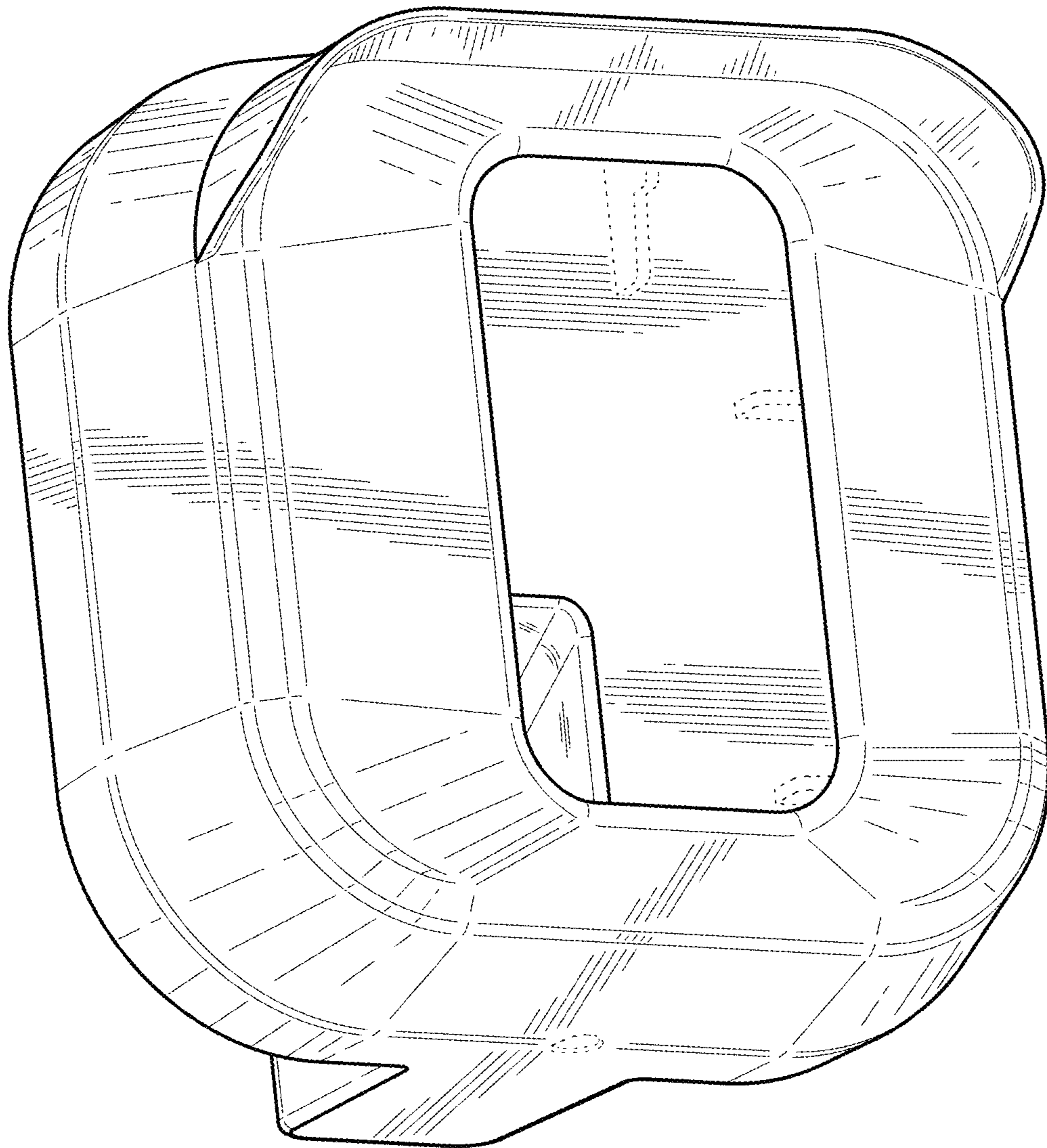

FIG. 1

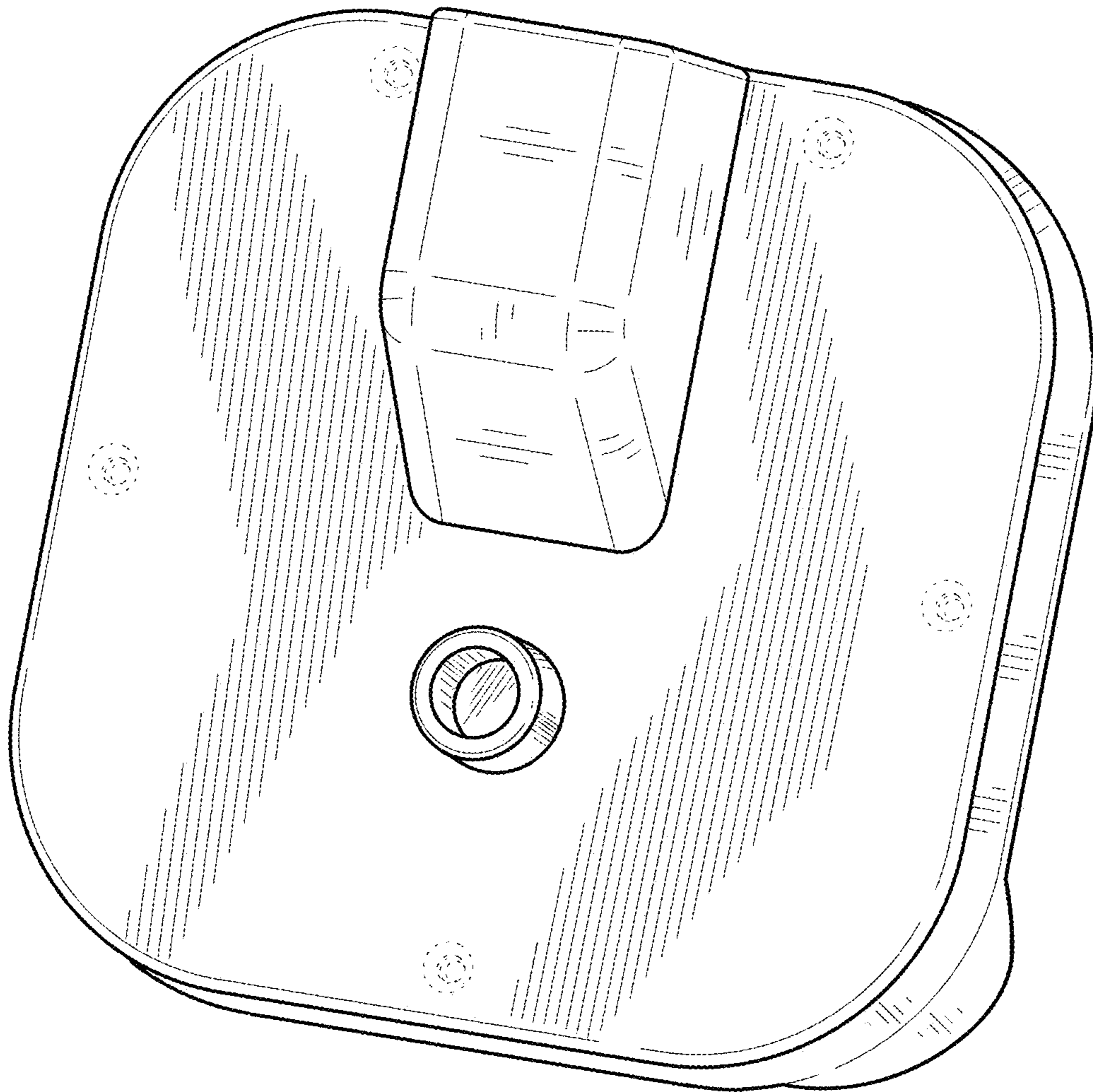

FIG. 2

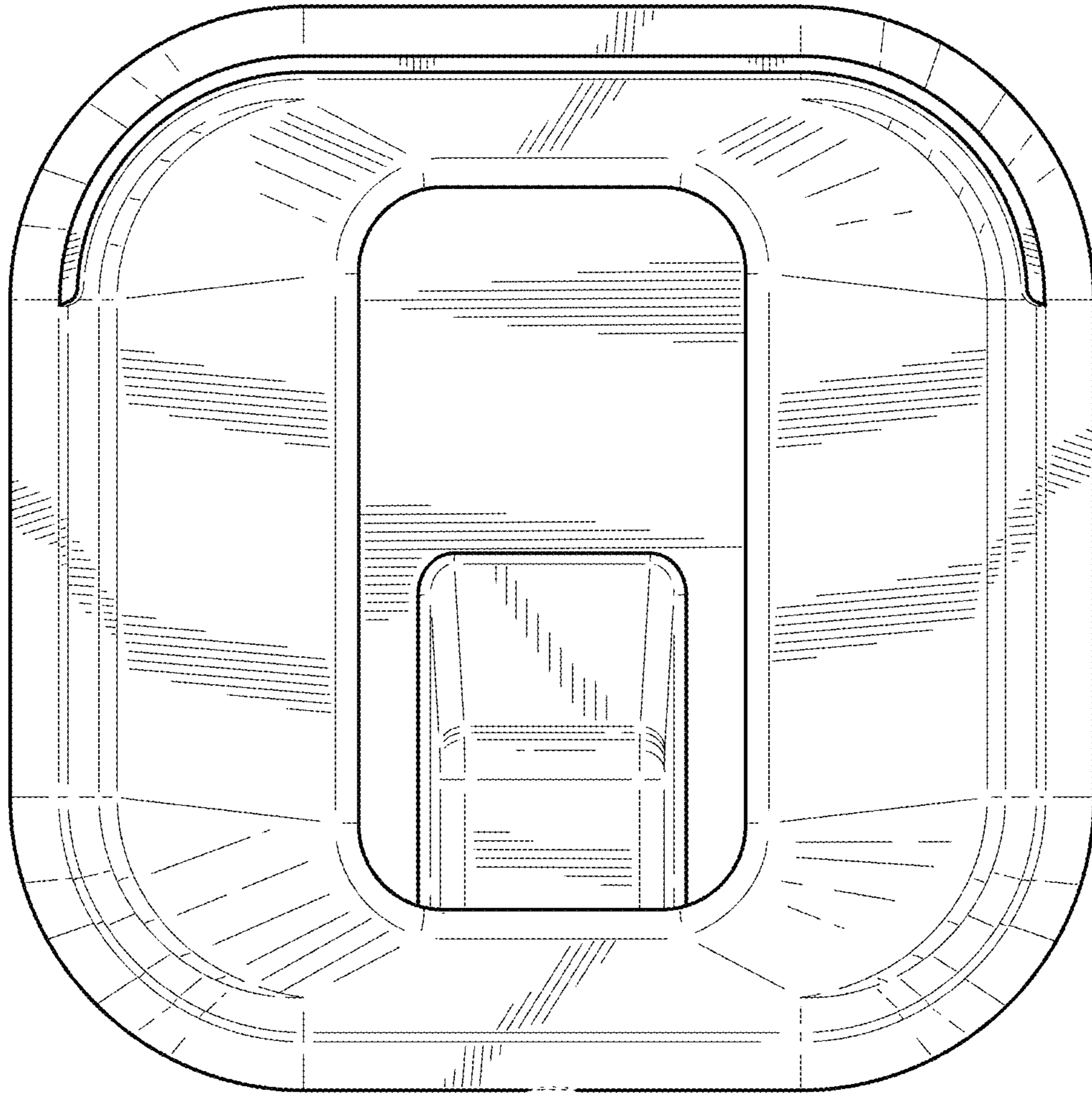

FIG. 3

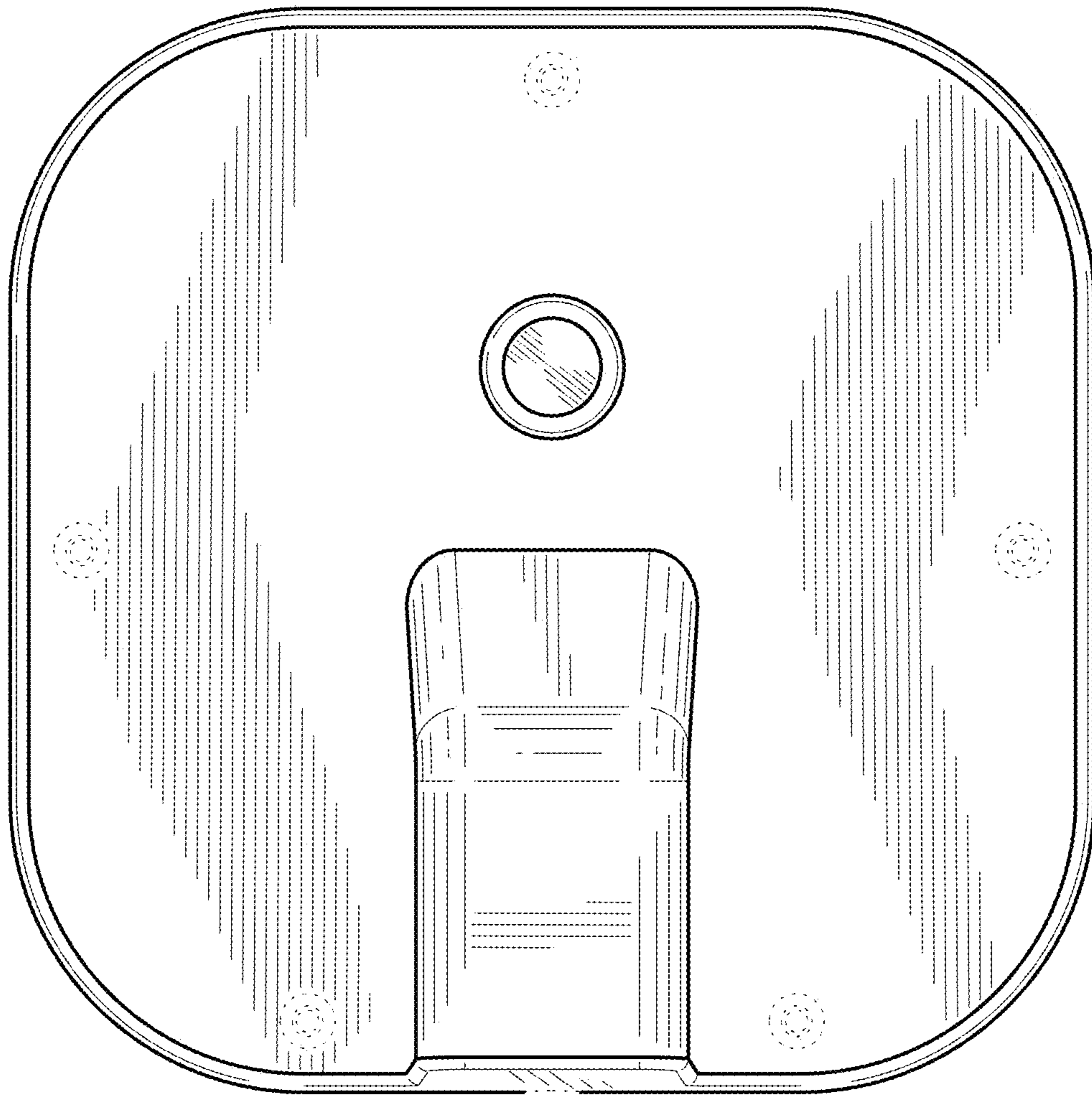

FIG. 4

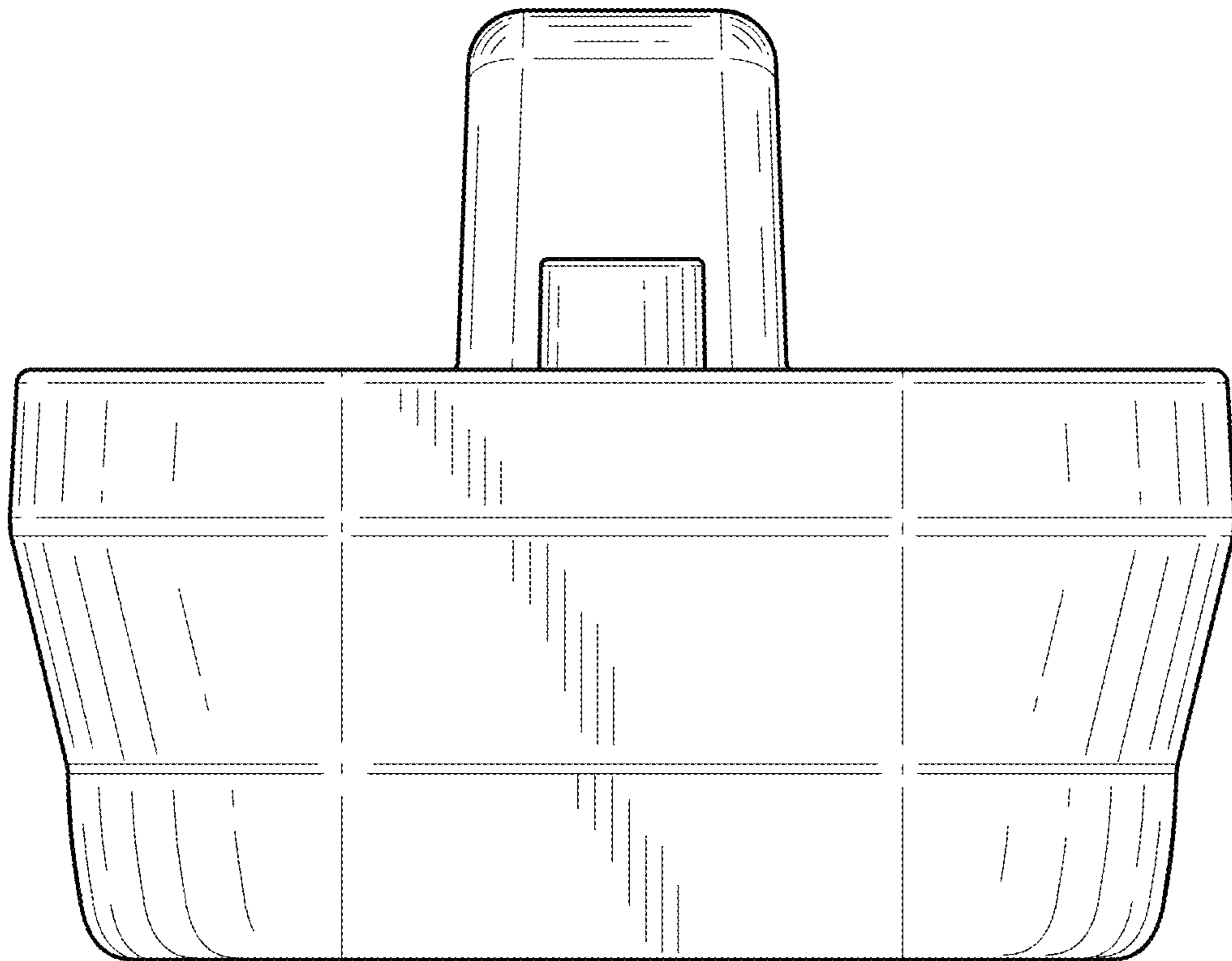

FIG. 5

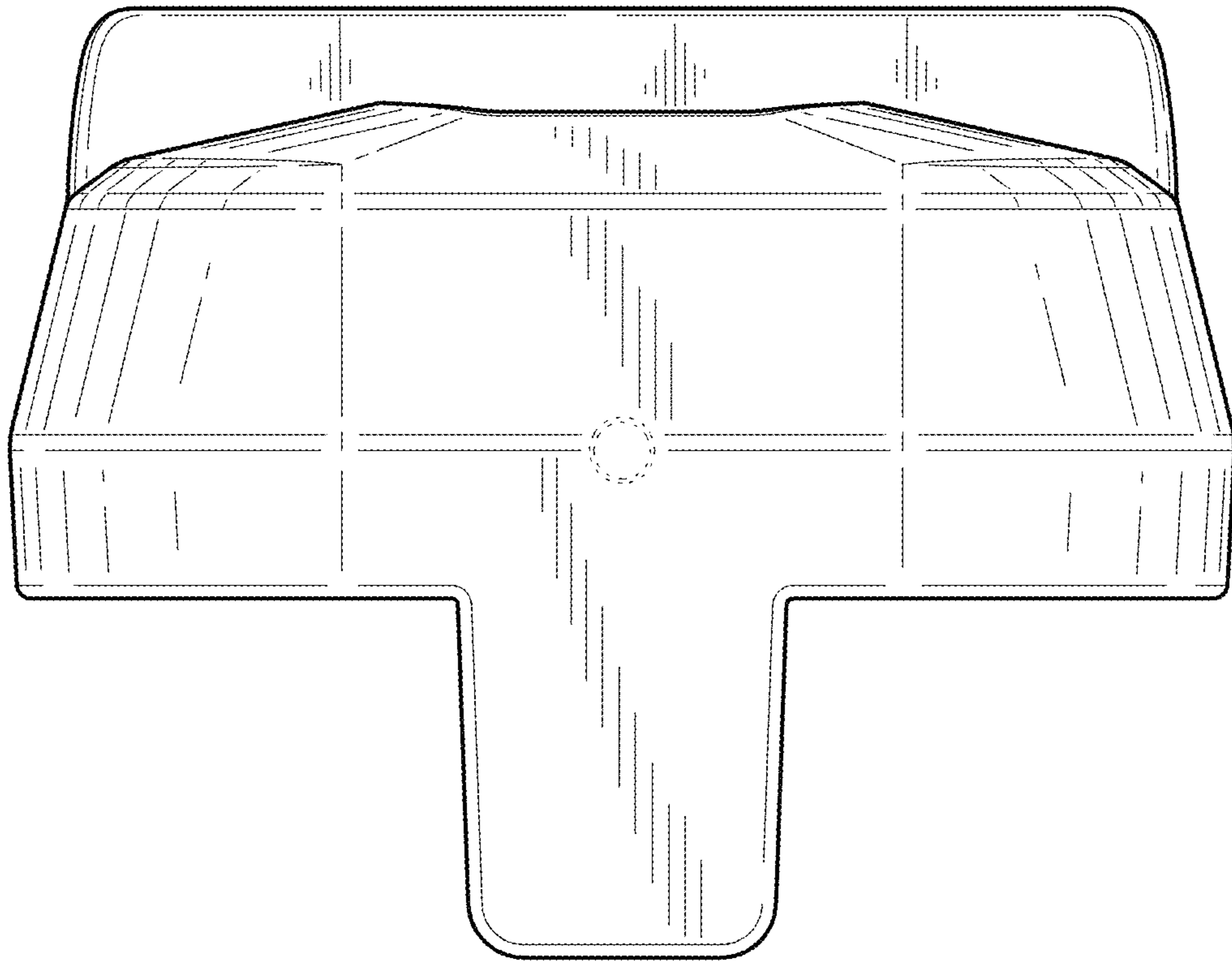

FIG. 6

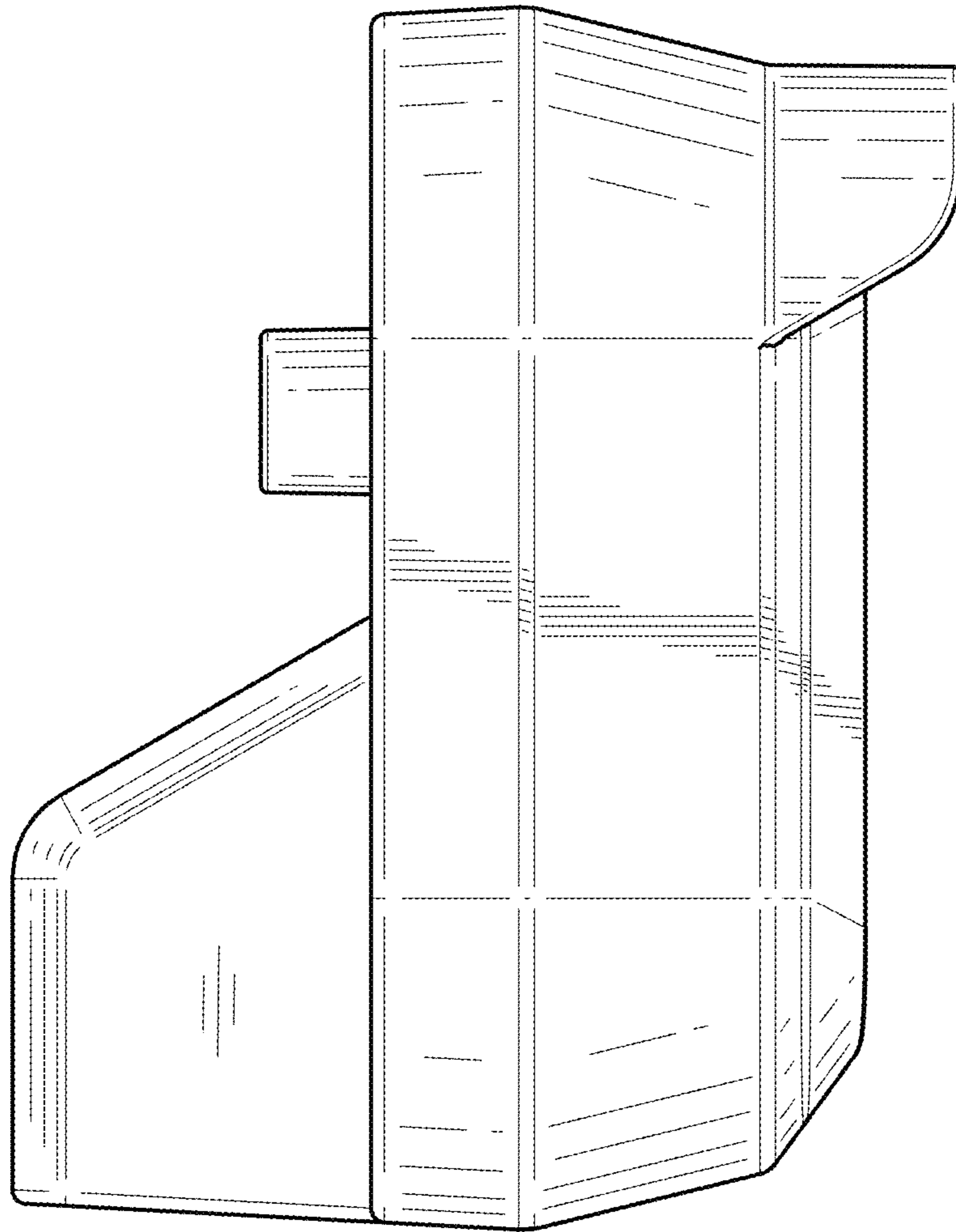

FIG. 7

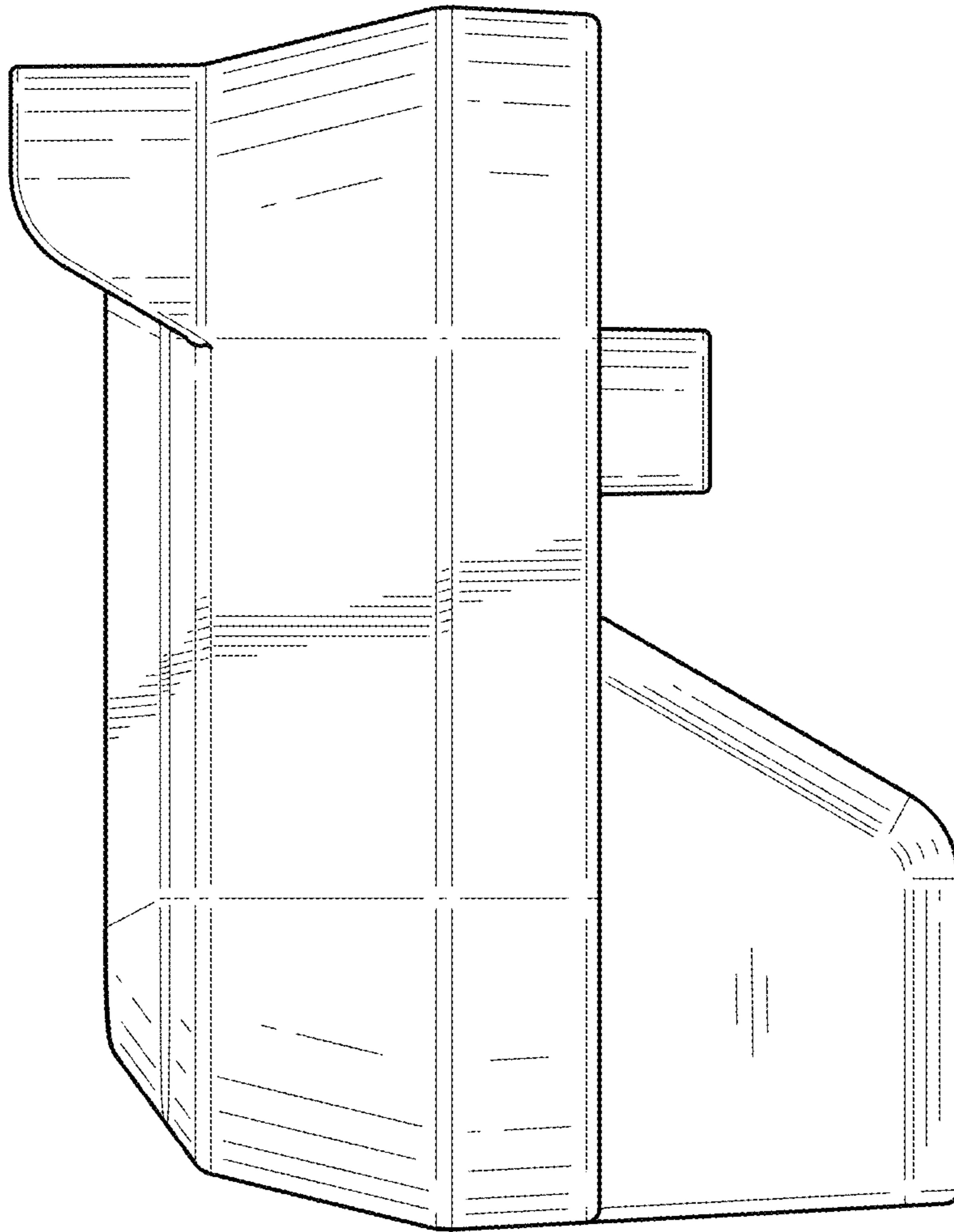

FIG. 8