



US00D873877S

(12) **United States Design Patent**  
**Weitschat et al.**

(10) **Patent No.:** **US D873,877 S**  
(45) **Date of Patent:** **\*\* Jan. 28, 2020**

(54) **ROBOT AIRBAG**

(71) Applicant: **Deutsches Zentrum Für Luft- und Raumfahrt e.V.**, Cologne (DE)

(72) Inventors: **Roman Weitschat**, Munich (DE);  
**Hannes Höppner**, Munich (DE)

(73) Assignee: **Deutsches Zentrum Für Luft- und Raumfahrt e.V.**, Cologne (DE)

(\*\*) Term: **15 Years**

(21) Appl. No.: **29/630,341**

(22) Filed: **Dec. 20, 2017**

(30) **Foreign Application Priority Data**

Jun. 21, 2017 (EM) ..... 004060267-0001  
Jun. 21, 2017 (EM) ..... 004060267-0002

(Continued)

(51) **LOC (12) Cl.** ..... **15-09**

(52) **U.S. Cl.**  
USPC ..... **D15/199**

(58) **Field of Classification Search**  
USPC ..... D12/177; D15/122, 199; D21/578-583,  
D21/621, 622

(Continued)

(56) **References Cited**

**U.S. PATENT DOCUMENTS**

D764,823 S \* 8/2016 Oomen ..... D6/361  
D775,479 S \* 1/2017 Oomen ..... D6/361

(Continued)

**OTHER PUBLICATIONS**

[www.theverge.com/circuitbreaker/2017/8/30/16225470/robot-airbags-industrial-cobots](http://www.theverge.com/circuitbreaker/2017/8/30/16225470/robot-airbags-industrial-cobots) (Year: 2017).\*

*Primary Examiner* — Patricia A Palasik

(74) *Attorney, Agent, or Firm* — Dorton & Willis, LLP

(57) **CLAIM**

The ornamental design for a robot airbag, as shown and described.

**DESCRIPTION**

FIG. 1 is a front, right isometric view of our new robot airbag design, wherein the robot airbag is in an activated state;

FIG. 2 is a front, right isometric view thereof;

FIG. 3 is a front elevation view thereof;

FIG. 4 is a rear elevation view thereof;

FIG. 5 is a right side elevation view thereof;

FIG. 6 is a left side elevation view thereof;

FIG. 7 is a top plan view thereof;

FIG. 8 is a bottom plan view thereof; and

FIG. 9 is a bottom right isometric view thereof.

FIG. 10 is a front, right isometric view of our new robot airbag design, wherein the robot airbag is in an un-activated state;

FIG. 11 is a front, right isometric view thereof;

FIG. 12 is a front elevation view thereof;

FIG. 13 is a rear elevation view thereof;

FIG. 14 is a right side elevation view thereof;

FIG. 15 is a left side elevation view thereof;

FIG. 16 is a top plan view thereof;

FIG. 17 is a bottom plan view thereof; and

FIG. 18 is a bottom right isometric view thereof.

FIG. 19 is a front, right isometric view of our new robot airbag design, wherein the robot airbag is in an activated state and is illuminated in a contrasting color;

FIG. 20 is a front, right isometric view thereof;

FIG. 21 is a front elevation view thereof;

FIG. 22 is a rear elevation view thereof;

FIG. 23 is a right side elevation view thereof;

FIG. 24 is a left side elevation view thereof;

FIG. 25 is a top plan view thereof;

FIG. 26 is a bottom plan view thereof; and,

FIG. 27 is a bottom right isometric view thereof.

The portions of FIGS, 1-27 that are shown in dot-dash broken lines form no part of the claimed invention. Neither the broken lines themselves nor the portions inside the

(Continued)

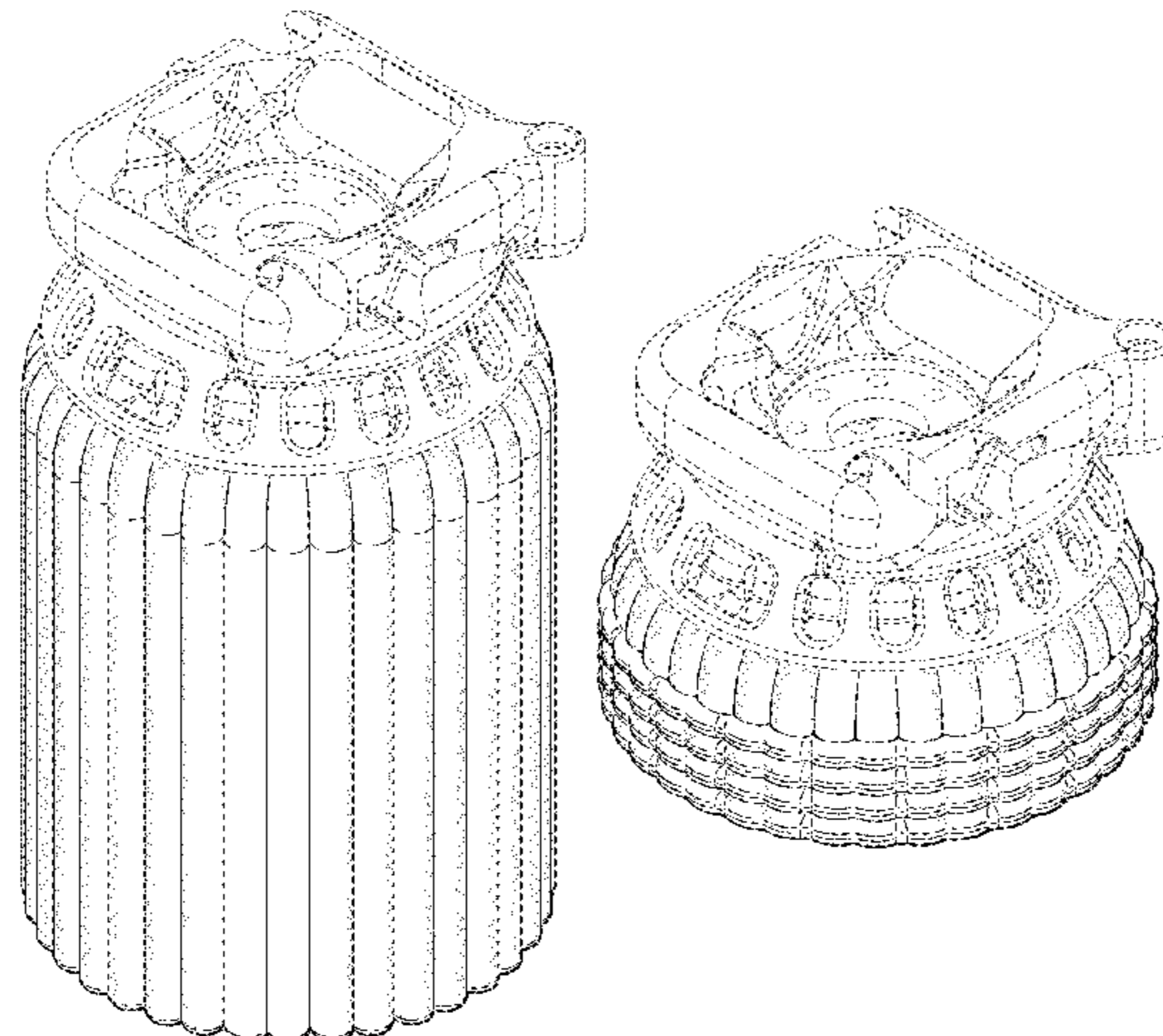

broken lines form any part of the claimed invention. More particularly, in FIGS. 1, 10 and 19, the robot airbag design is shown attached to a robotic arm to show environmental structures used with the robot airbag.

**1 Claim, 25 Drawing Sheets**

**(30) Foreign Application Priority Data**

Jun. 21, 2017 (EM) ..... 004060267-0003  
Jun. 21, 2017 (EM) ..... 004060267-0004  
Jun. 21, 2017 (EM) ..... 004060267-0005  
Jun. 21, 2017 (EM) ..... 004060267-0006  
Jun. 21, 2017 (EM) ..... 004060267-0007  
Jun. 21, 2017 (EM) ..... 004060267-0008

**(58) Field of Classification Search**

CPC ..... B25J 15/00; B25J 19/06; B25J 19/0075;  
B25J 19/0091

See application file for complete search history.

**(56) References Cited**

U.S. PATENT DOCUMENTS

D808,186 S \* 1/2018 Oomen ..... D6/361  
2016/0375590 A1 \* 12/2016 Lessing ..... B25J 15/12  
294/196  
2019/0047160 A1 \* 2/2019 Weitschat ..... B25J 15/00  
2019/0143537 A1 \* 5/2019 Schanz ..... B25J 15/0023

\* cited by examiner

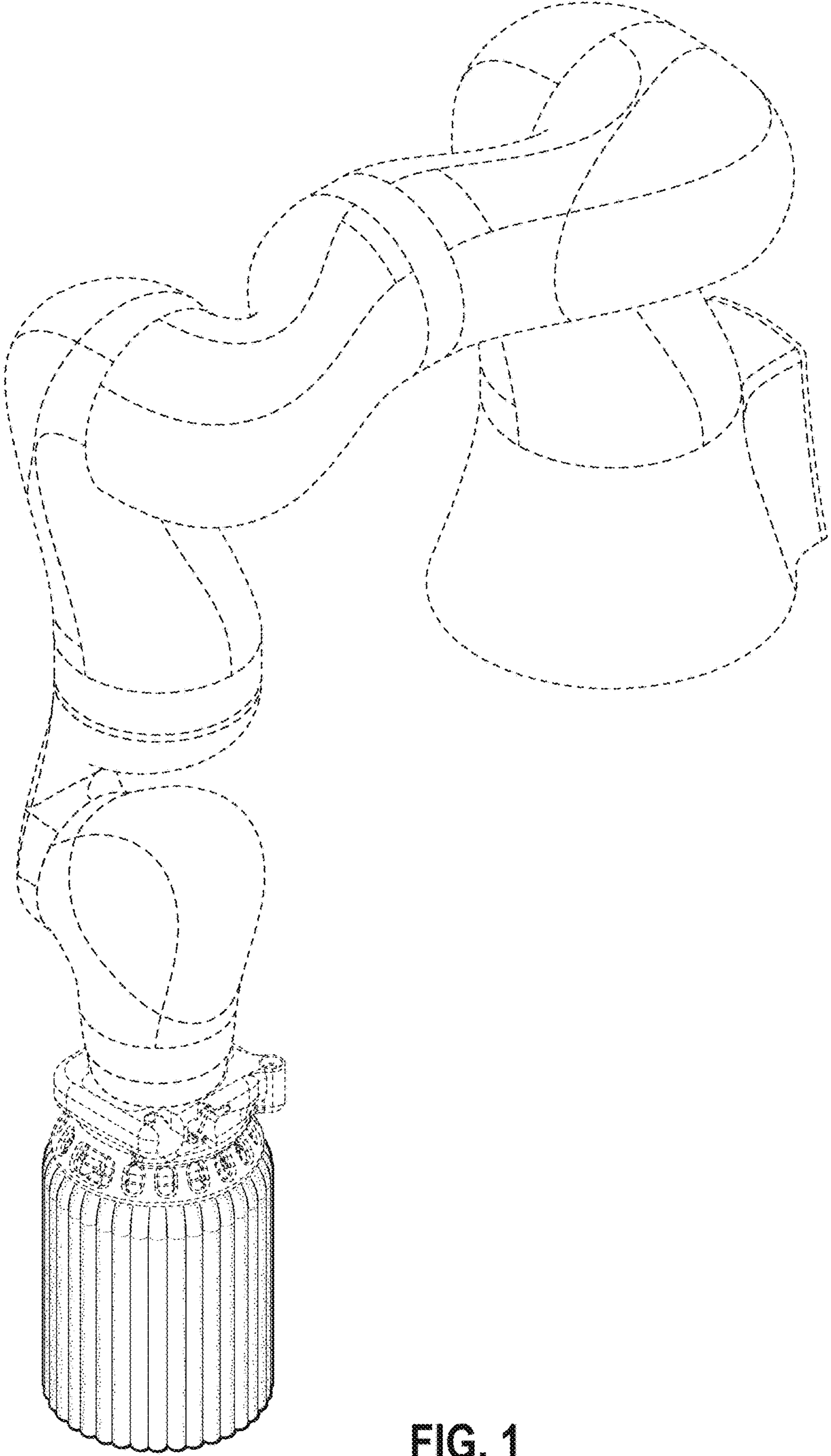

FIG. 1

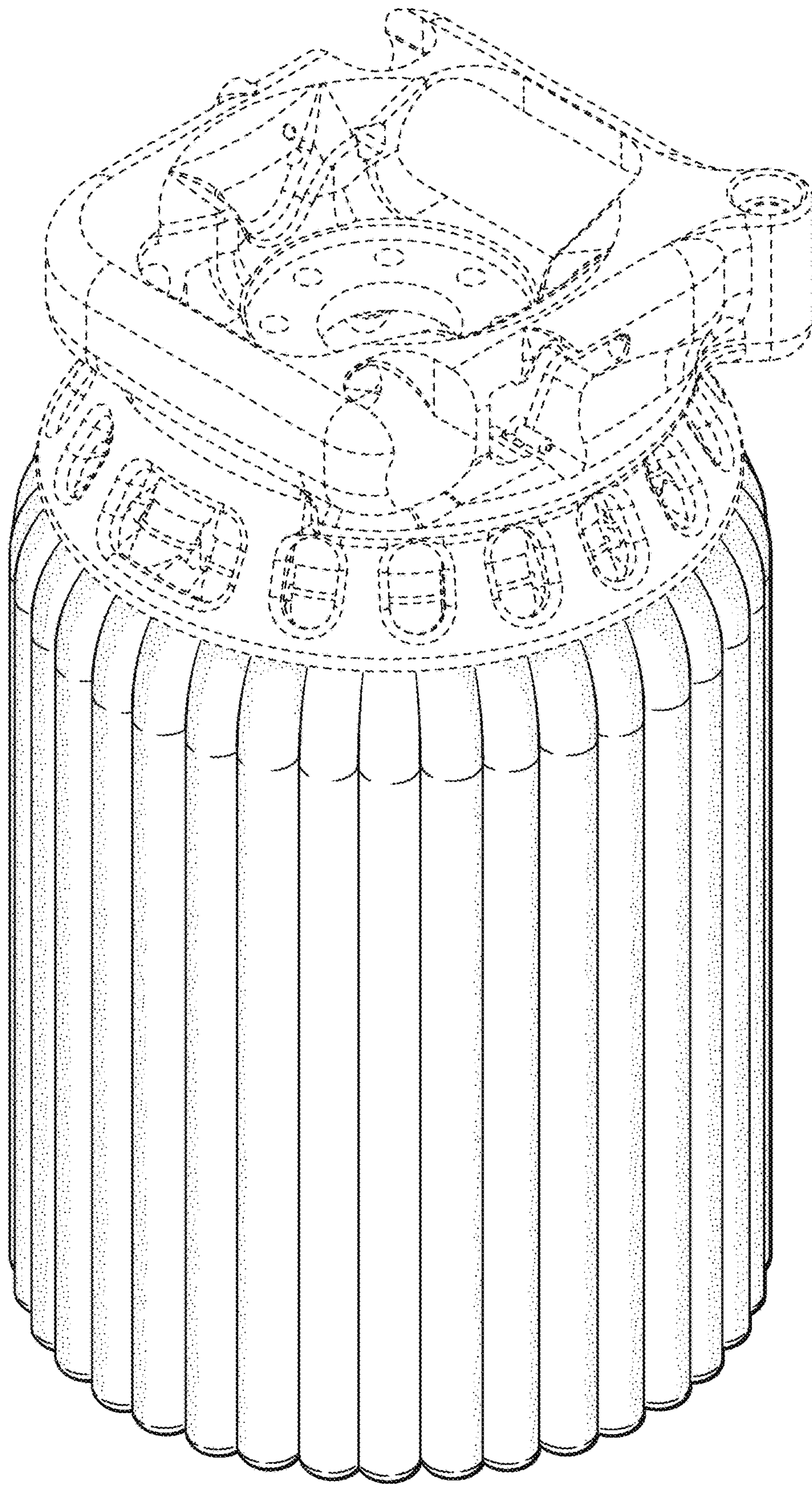

FIG. 2

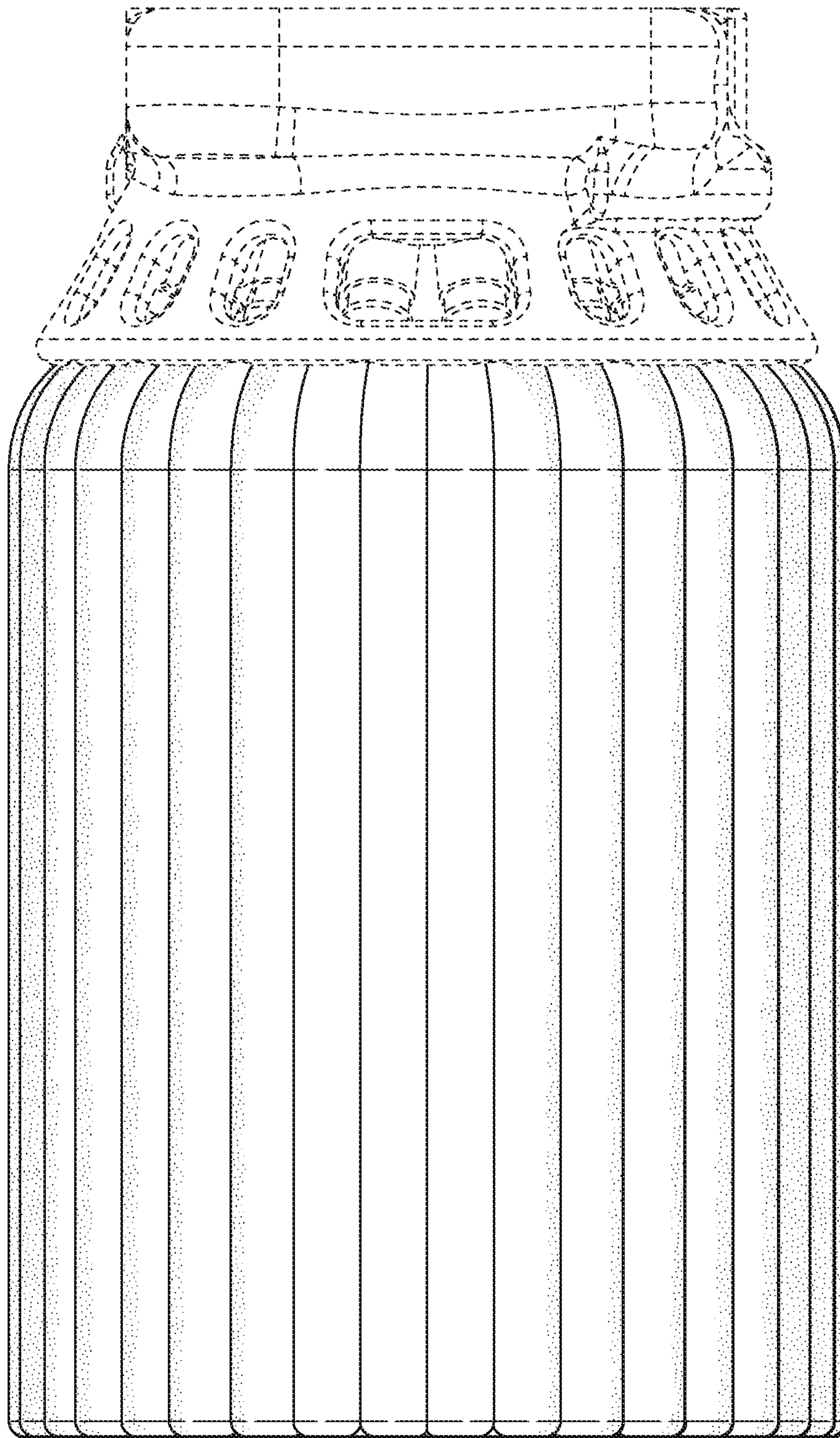

FIG. 3

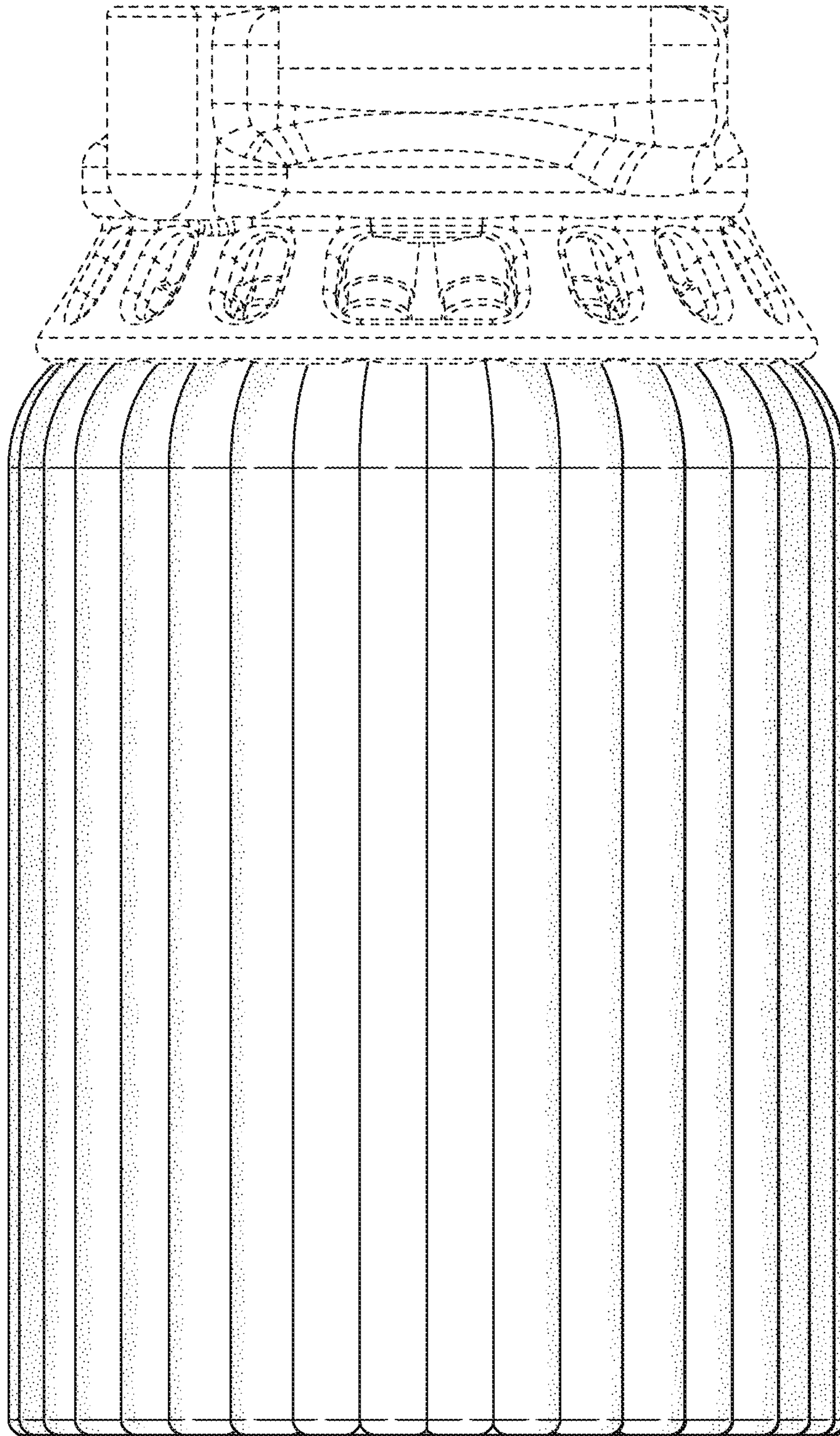

FIG. 4

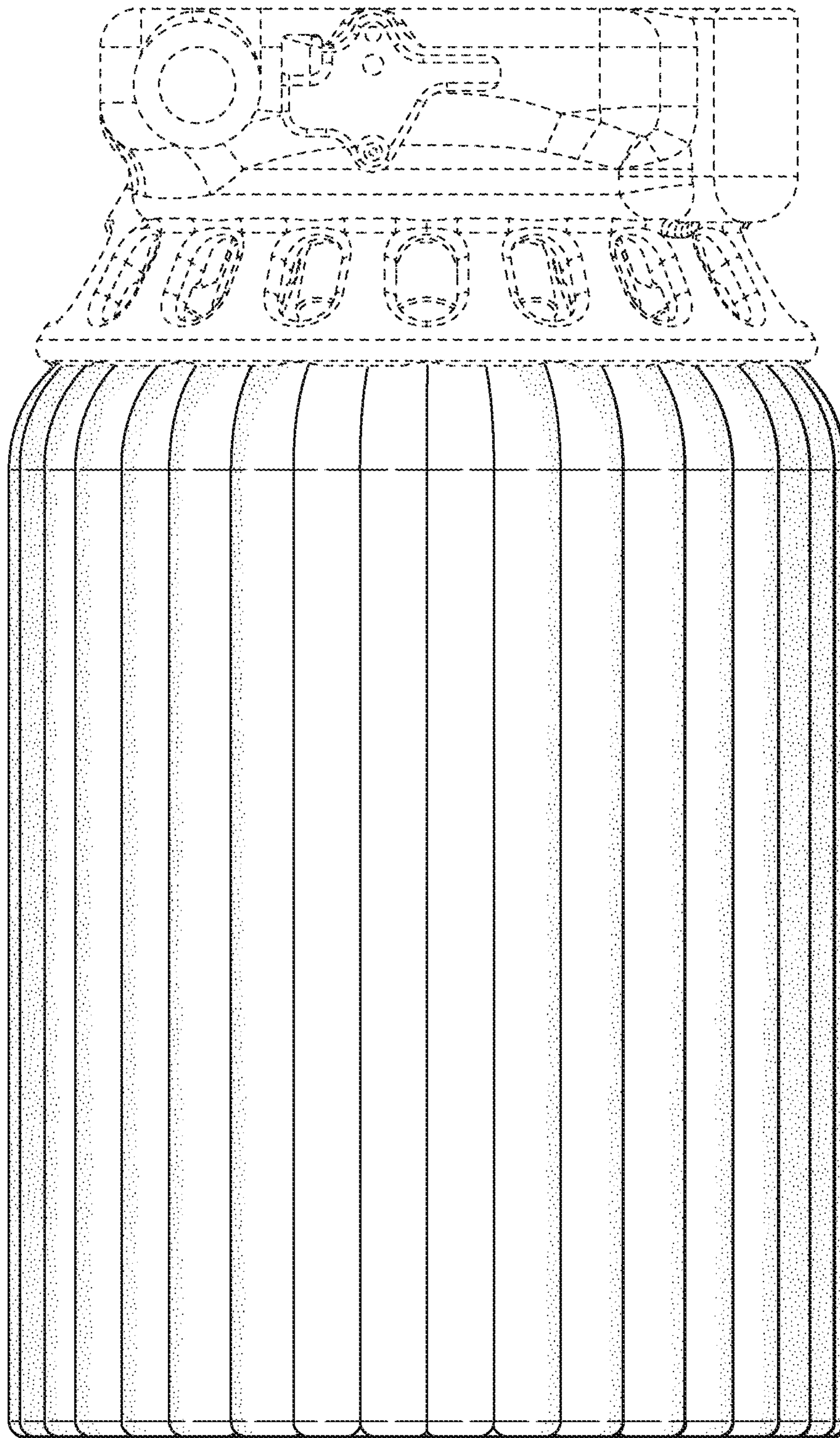

FIG. 5

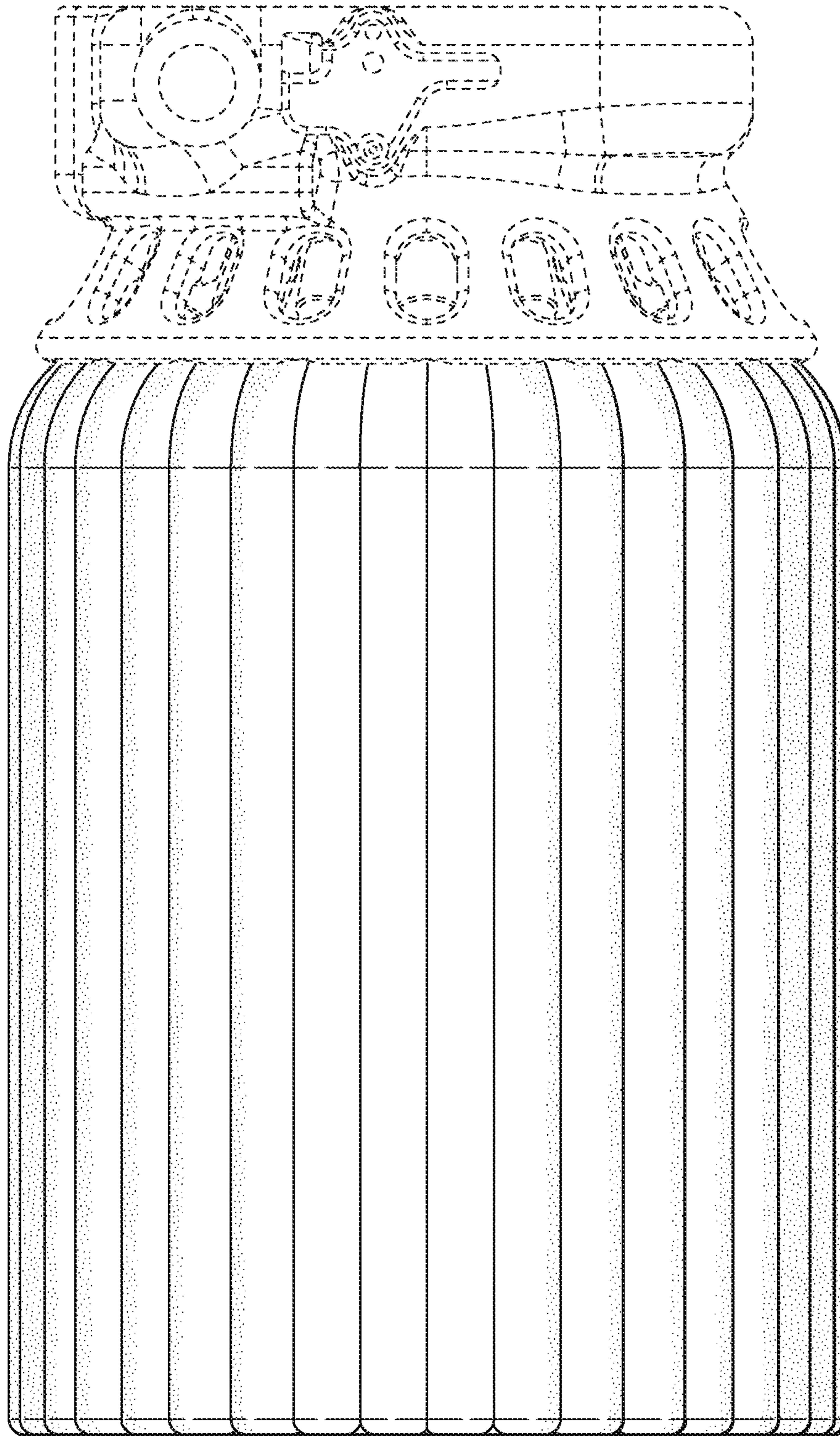

FIG. 6



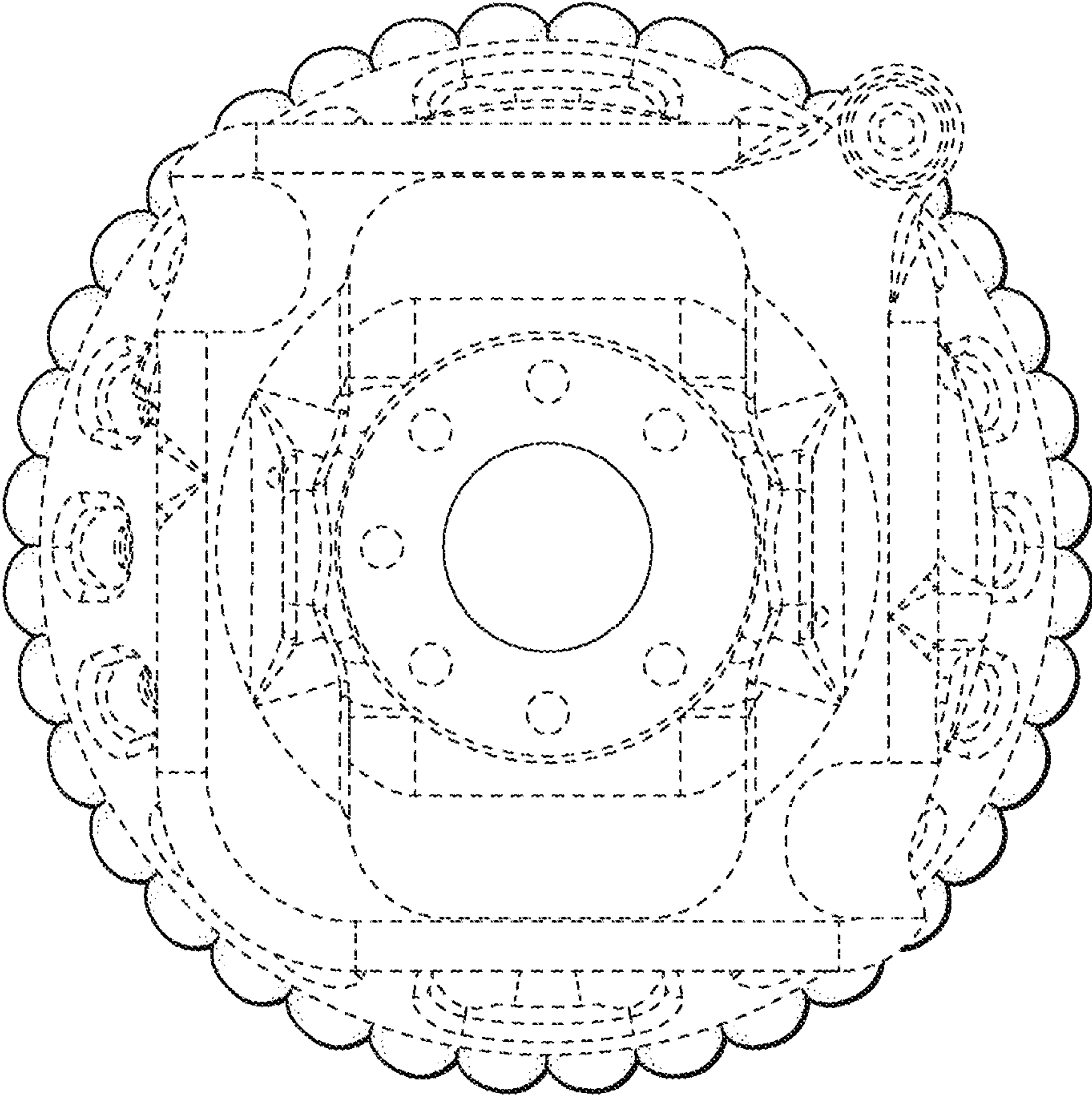
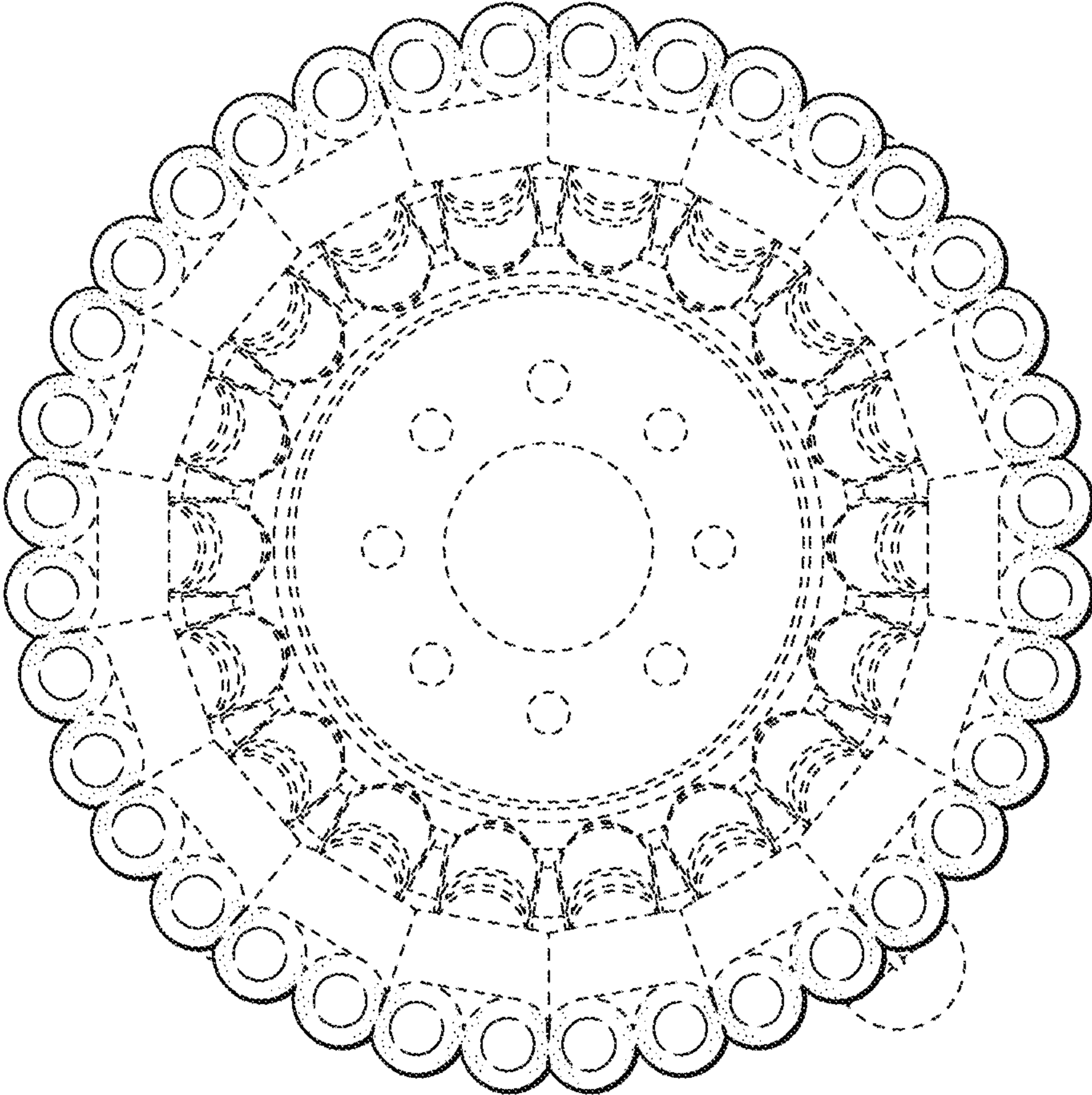

FIG. 7



**FIG. 8**

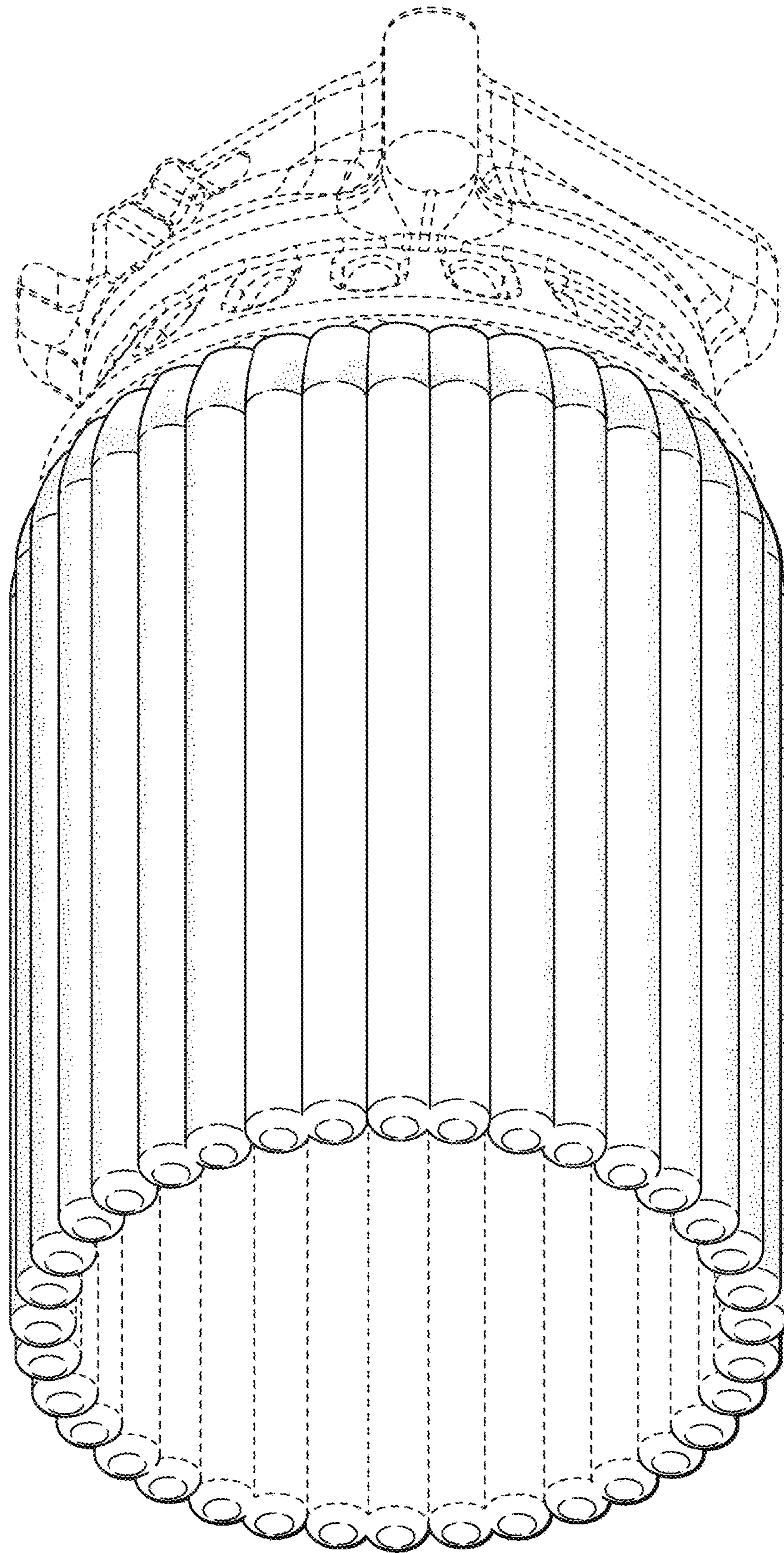

FIG. 9

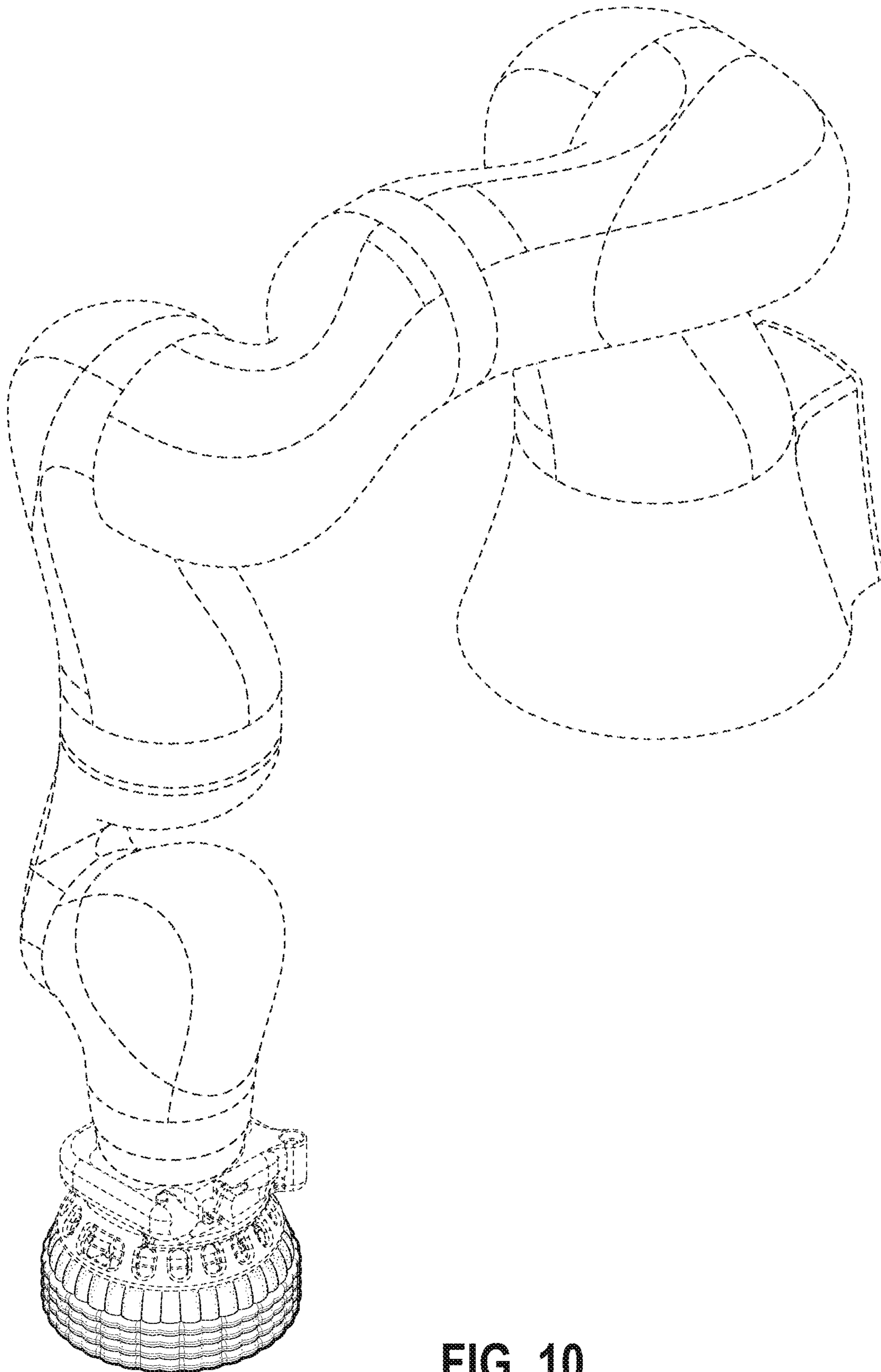

FIG. 10

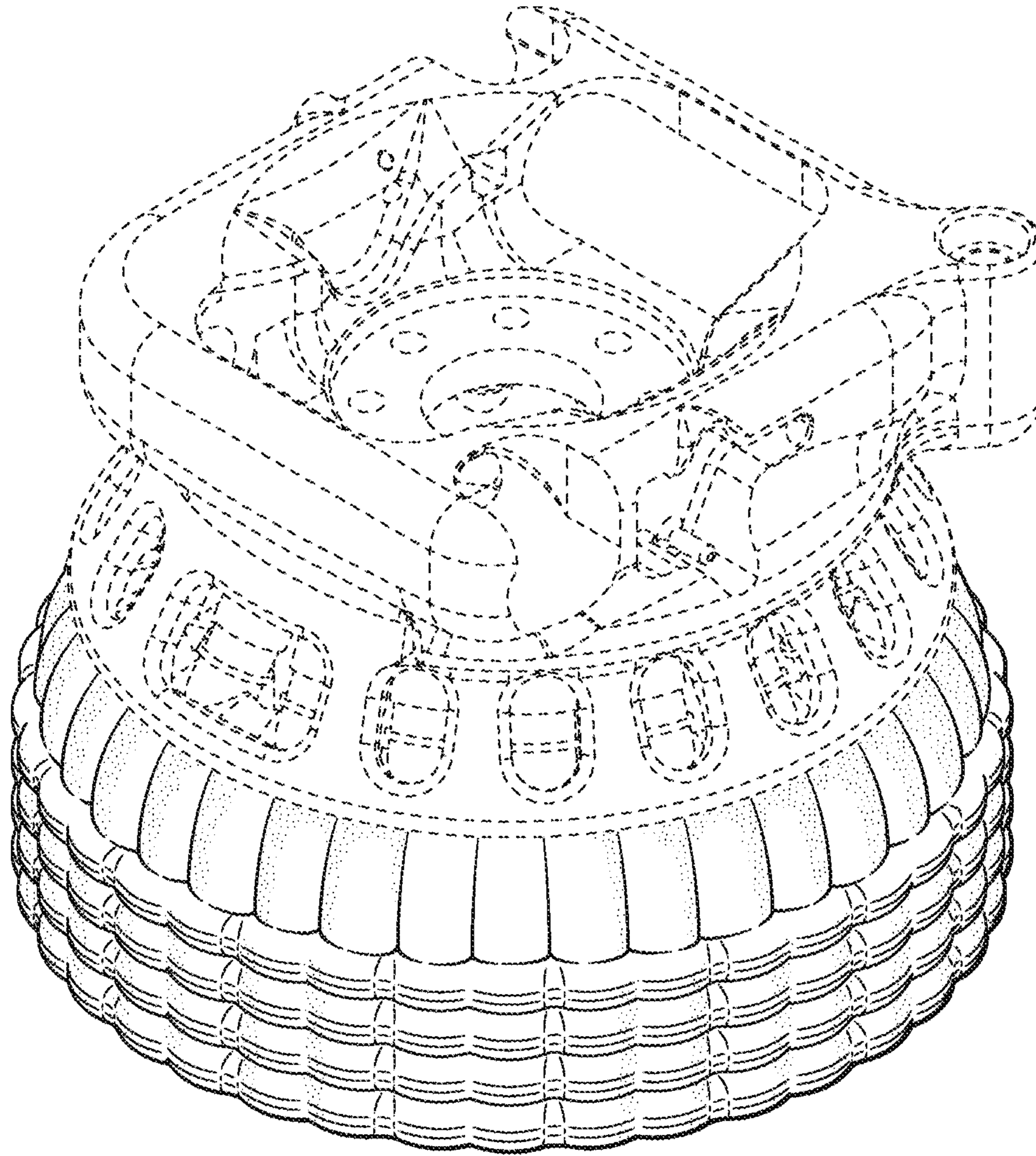

FIG. 11

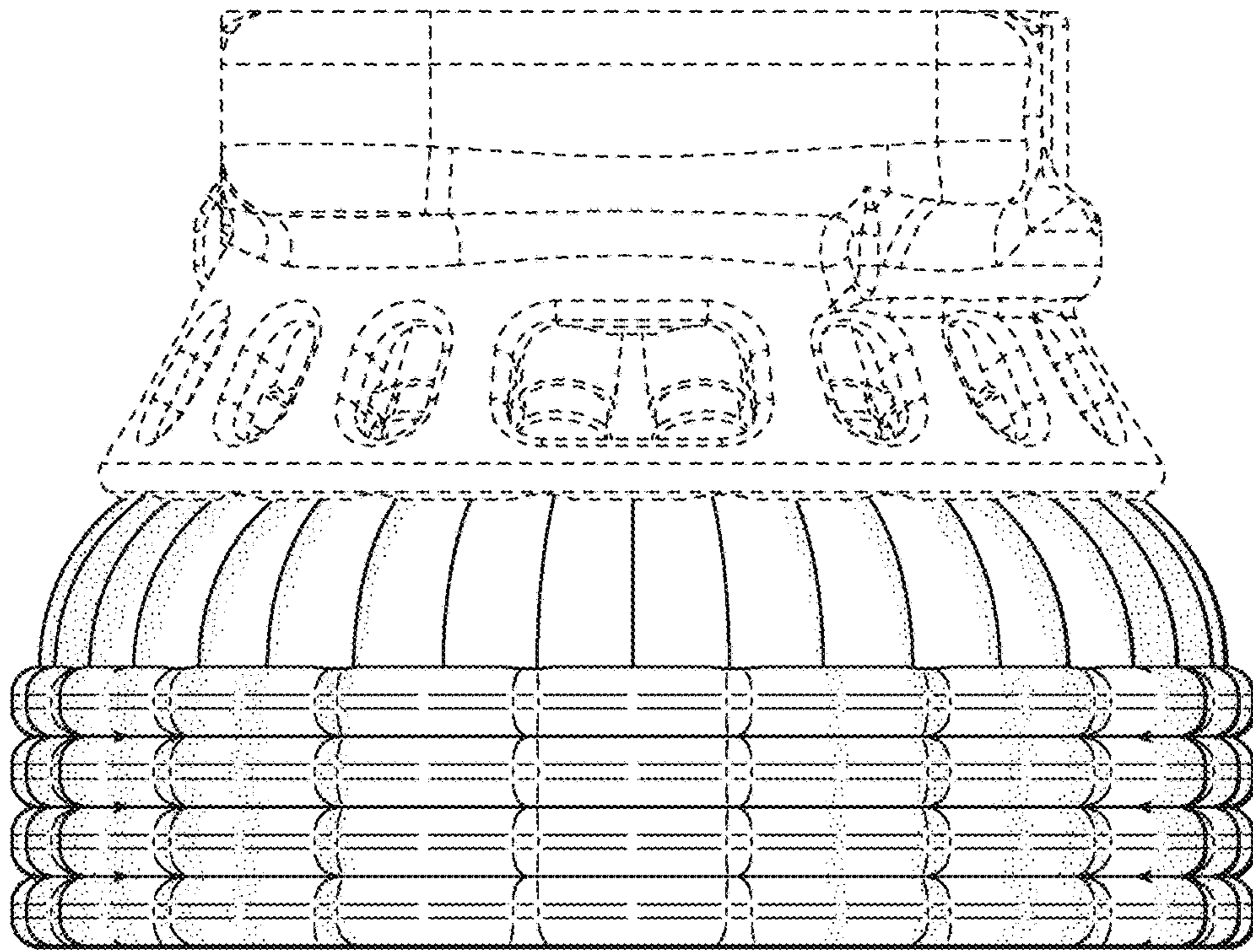

FIG. 12

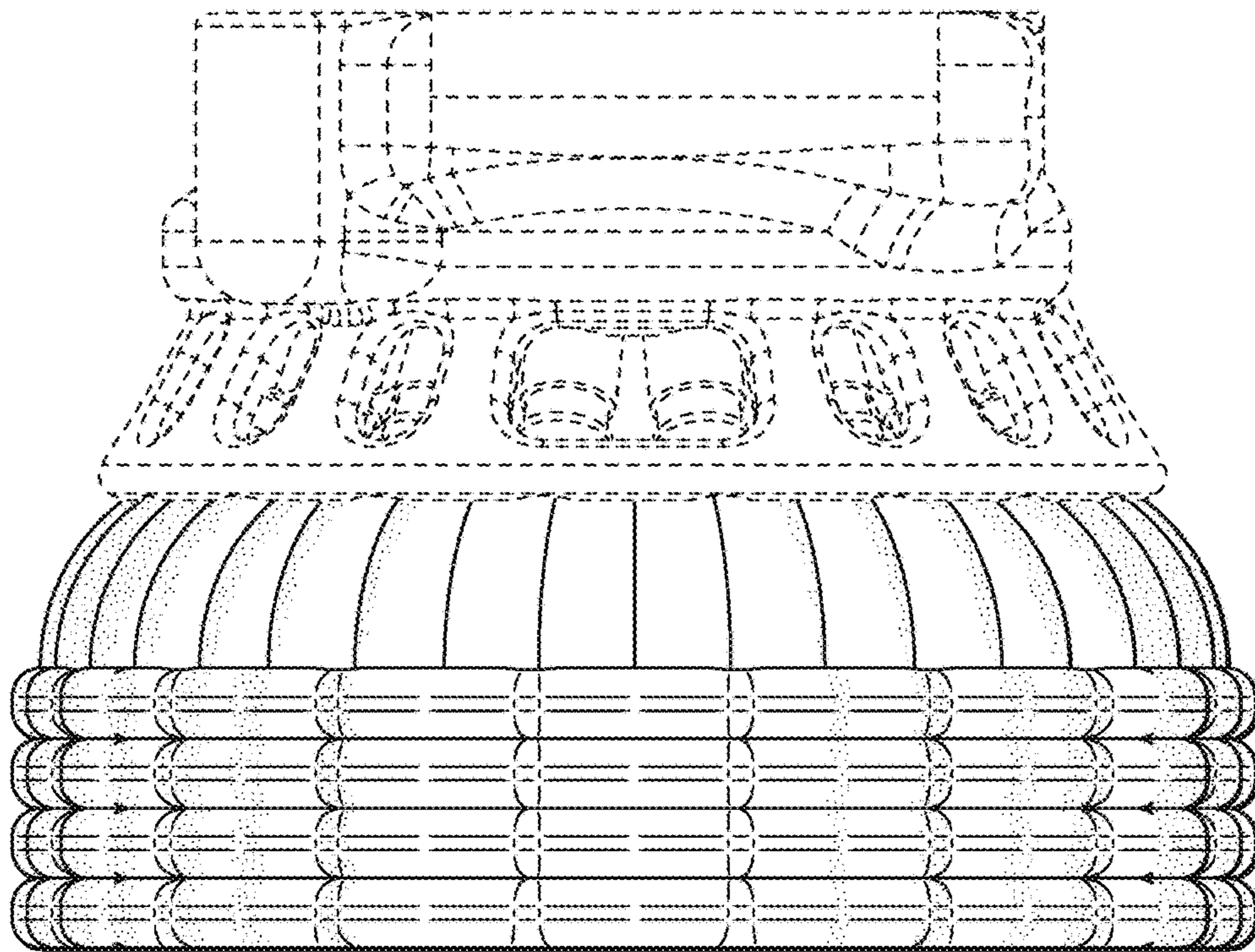

FIG. 13

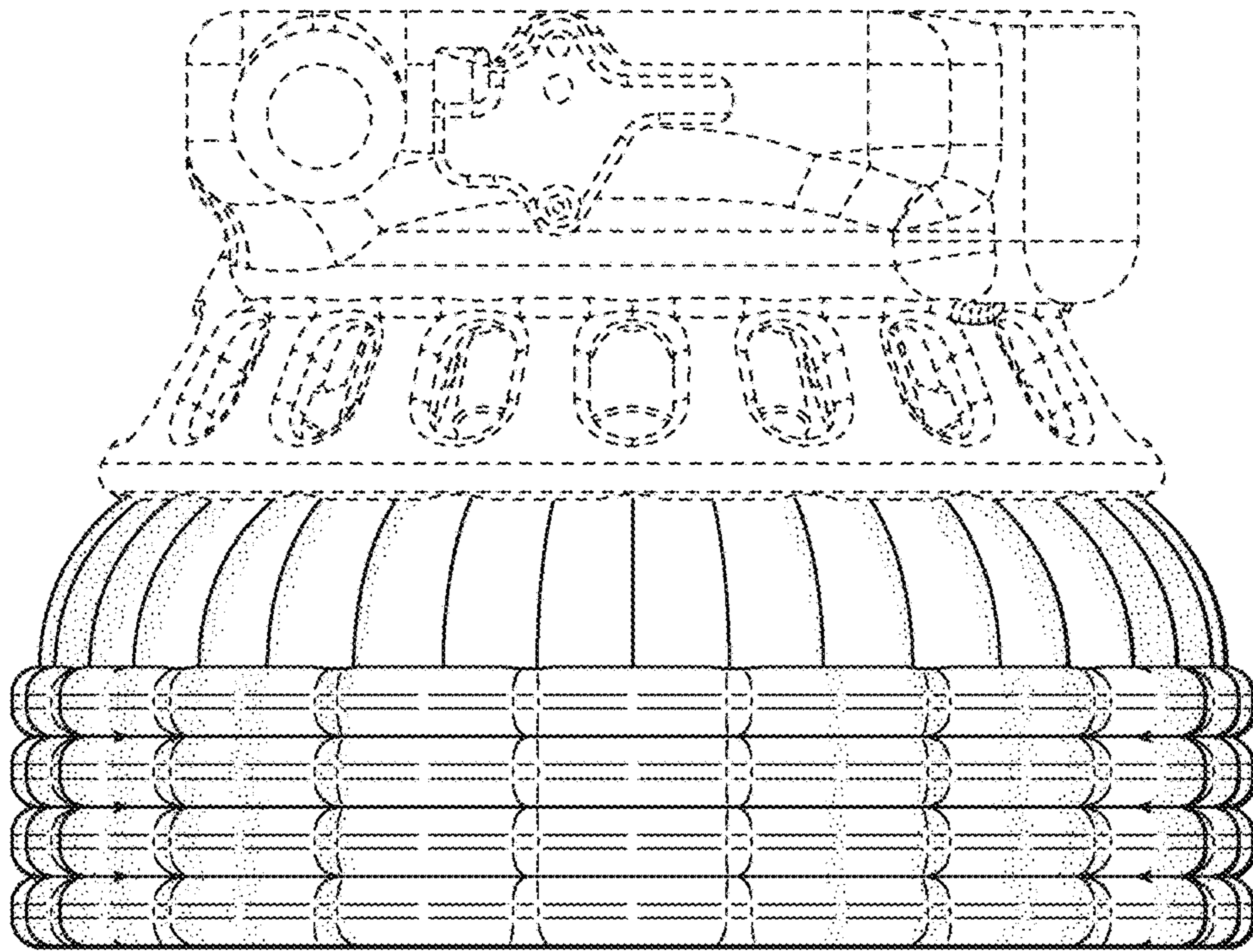

FIG. 14

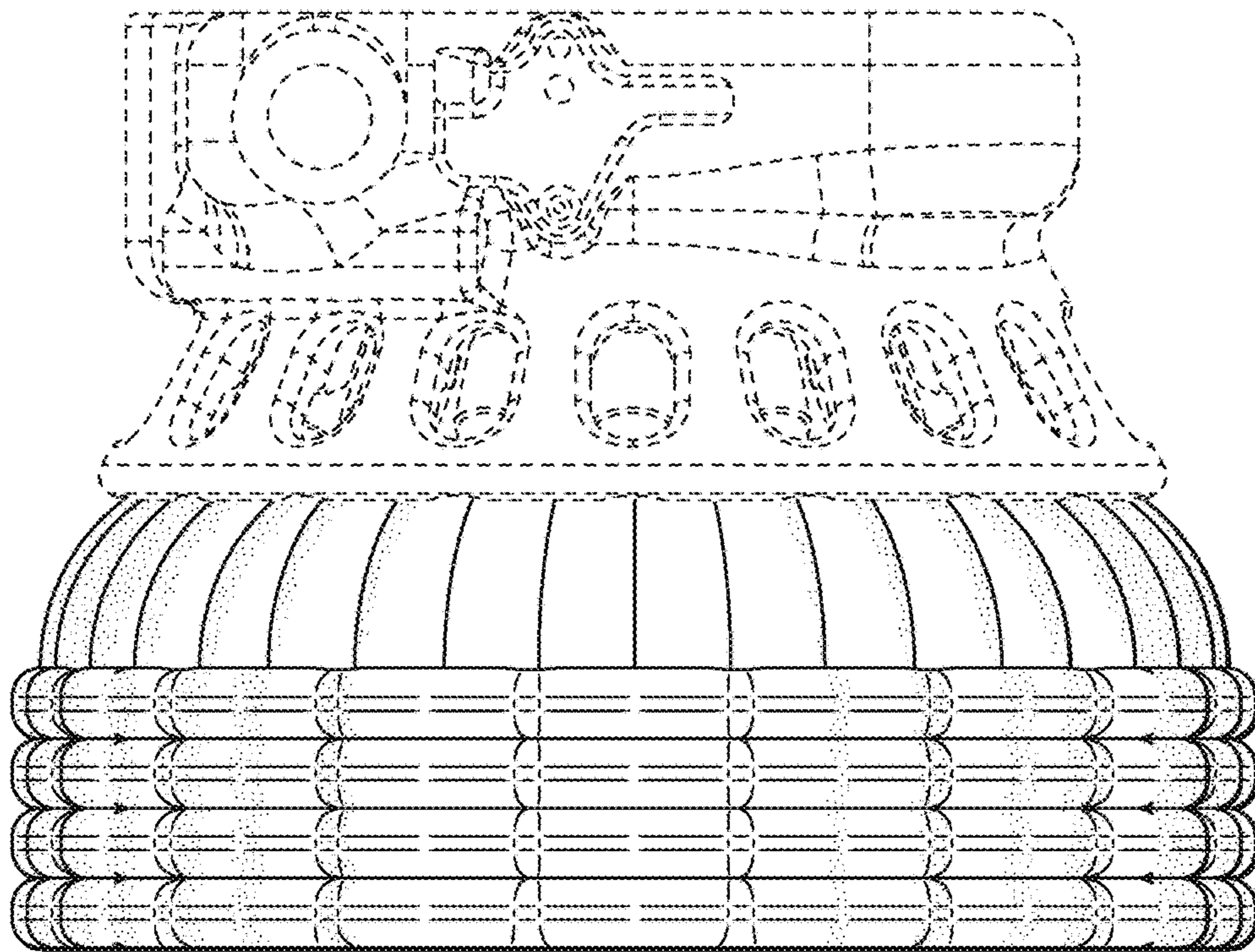

FIG. 15

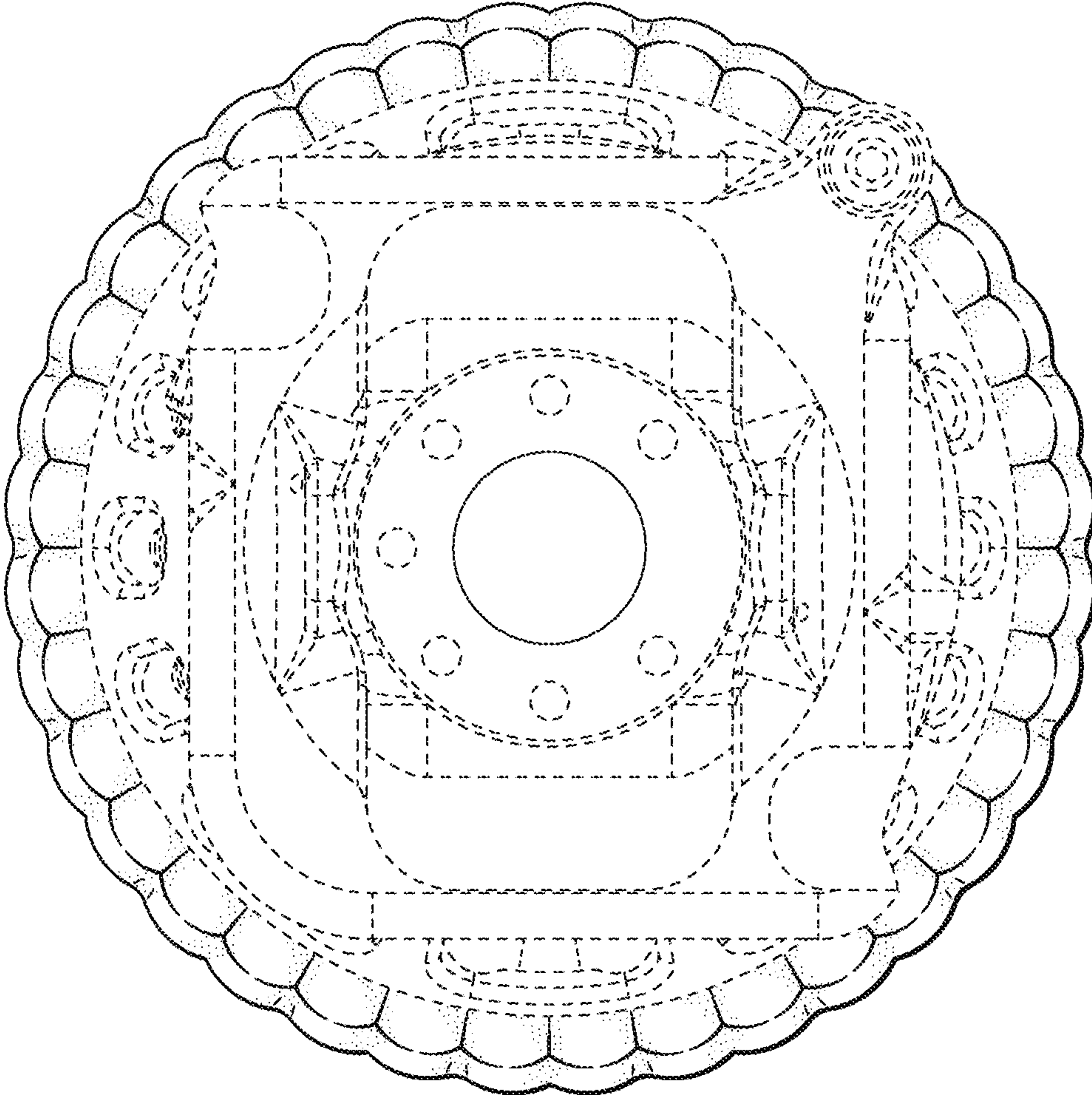

FIG. 16



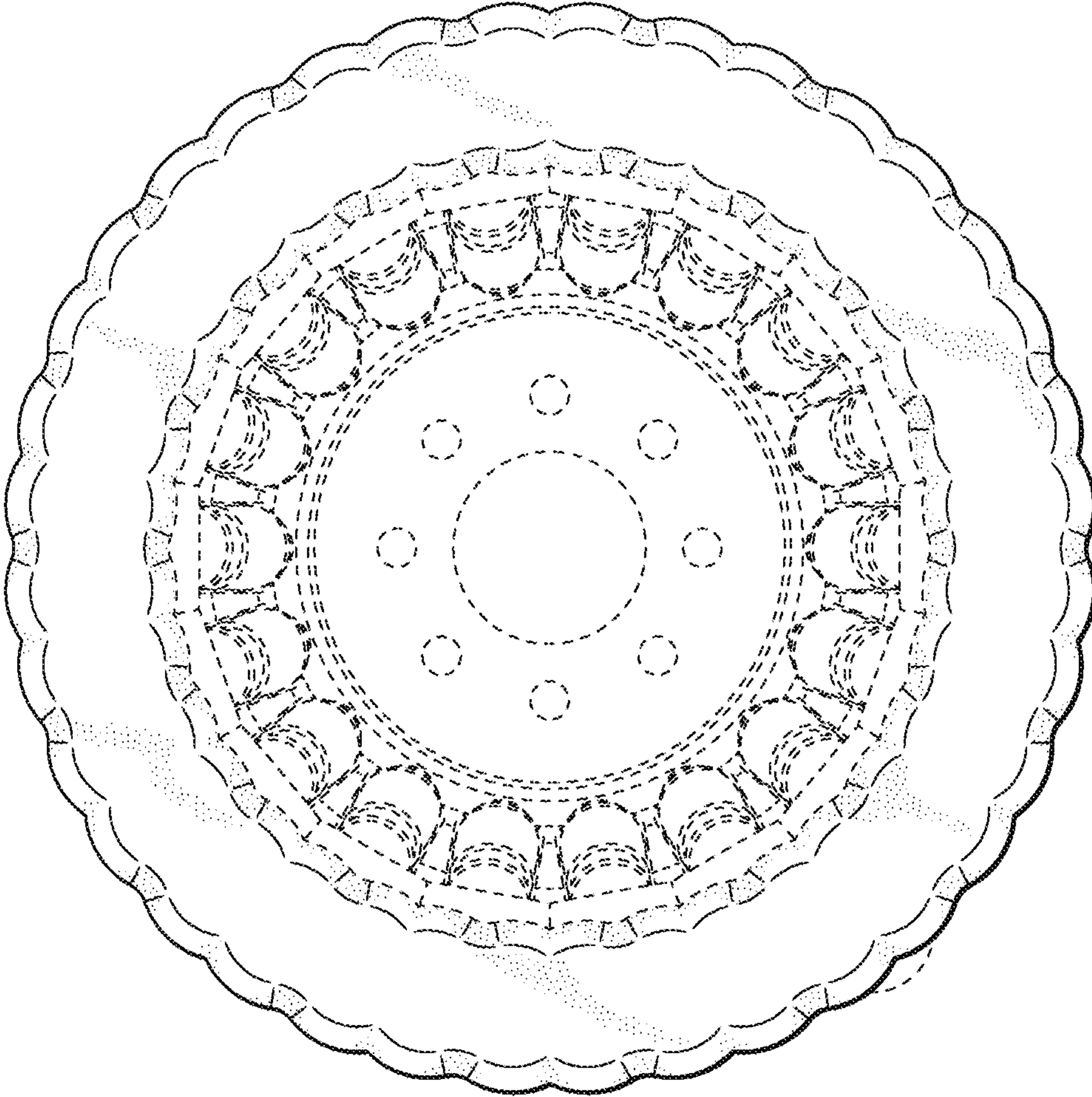

FIG. 17

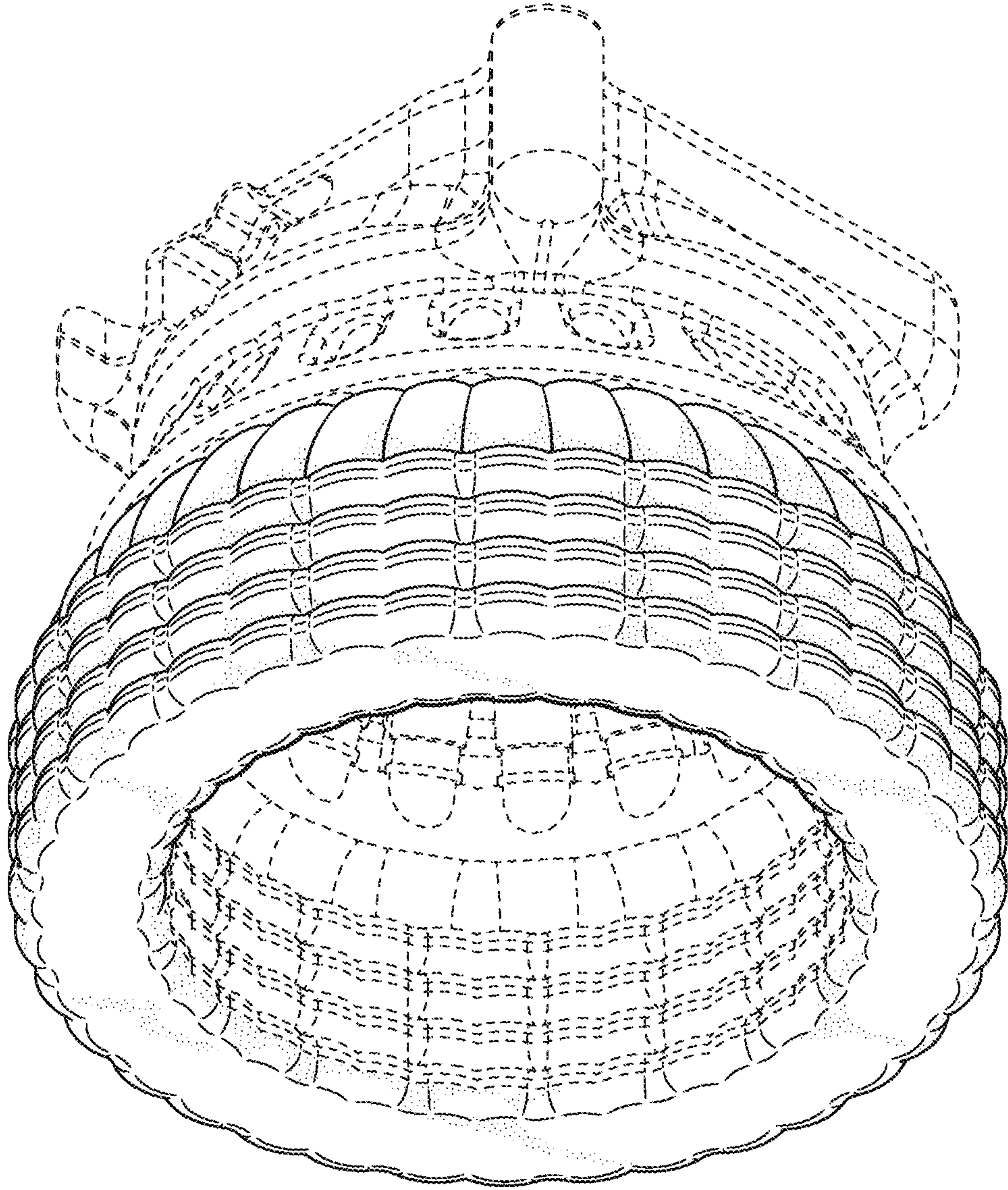

FIG. 18

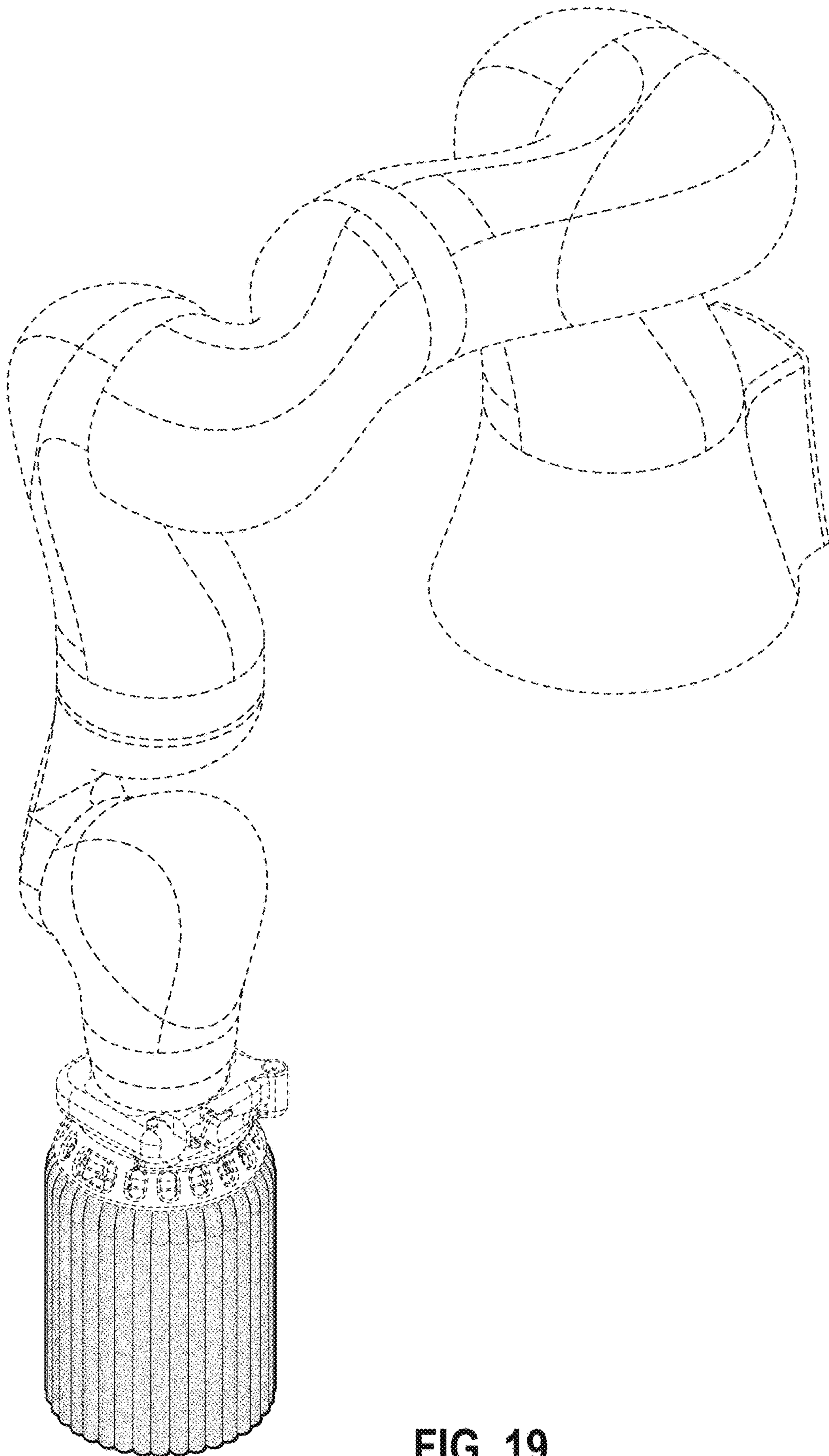

FIG. 19

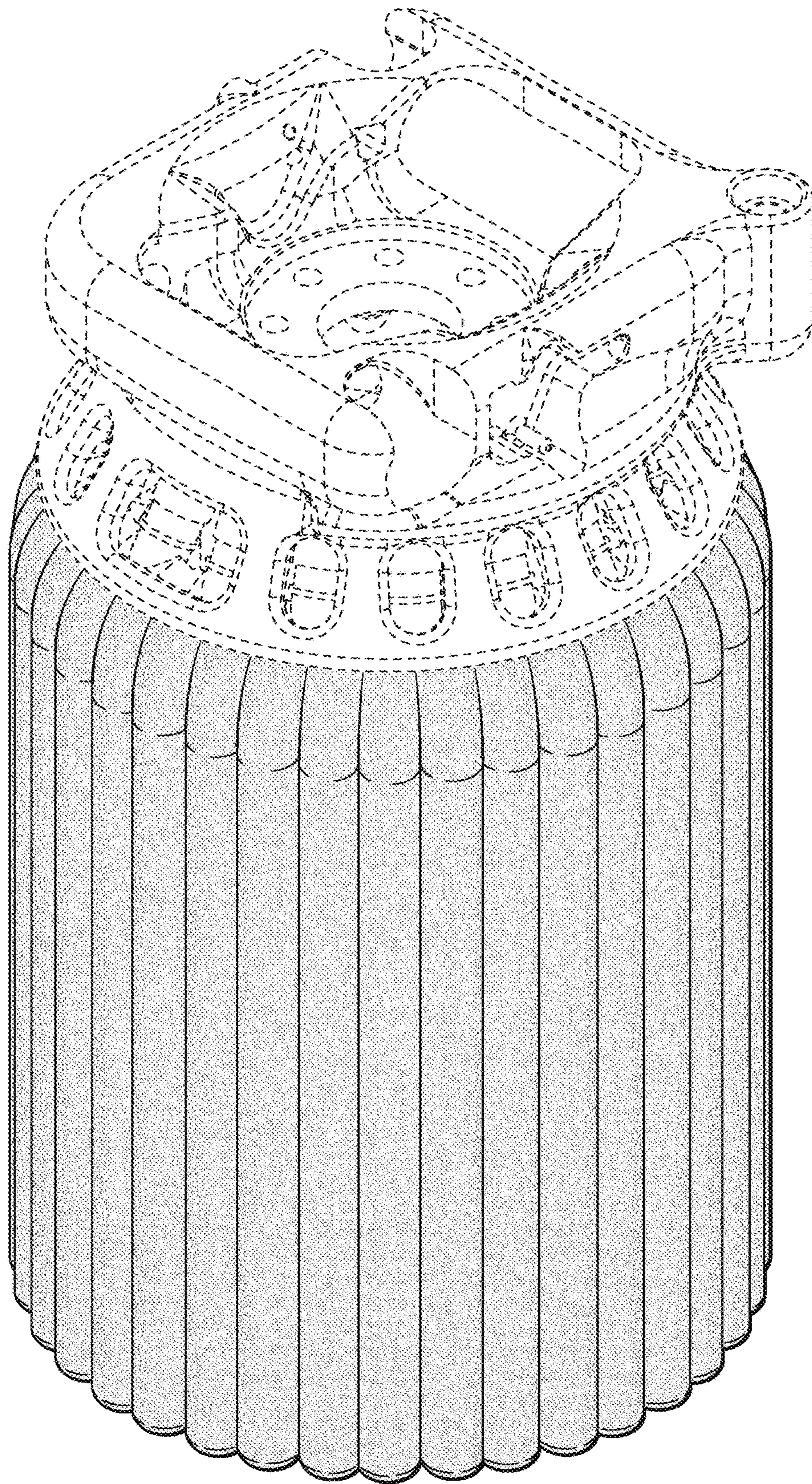

FIG. 20

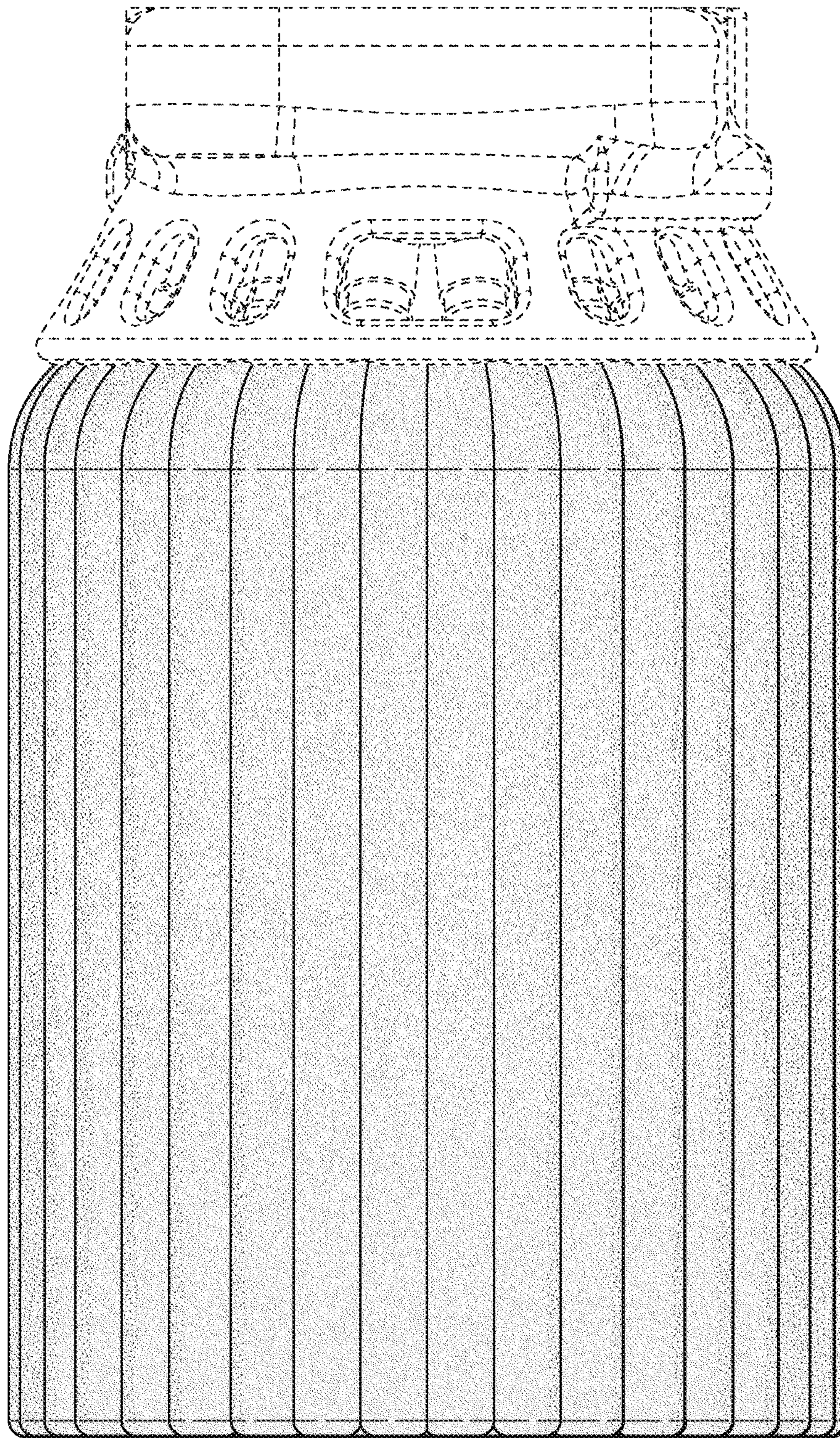

FIG. 21

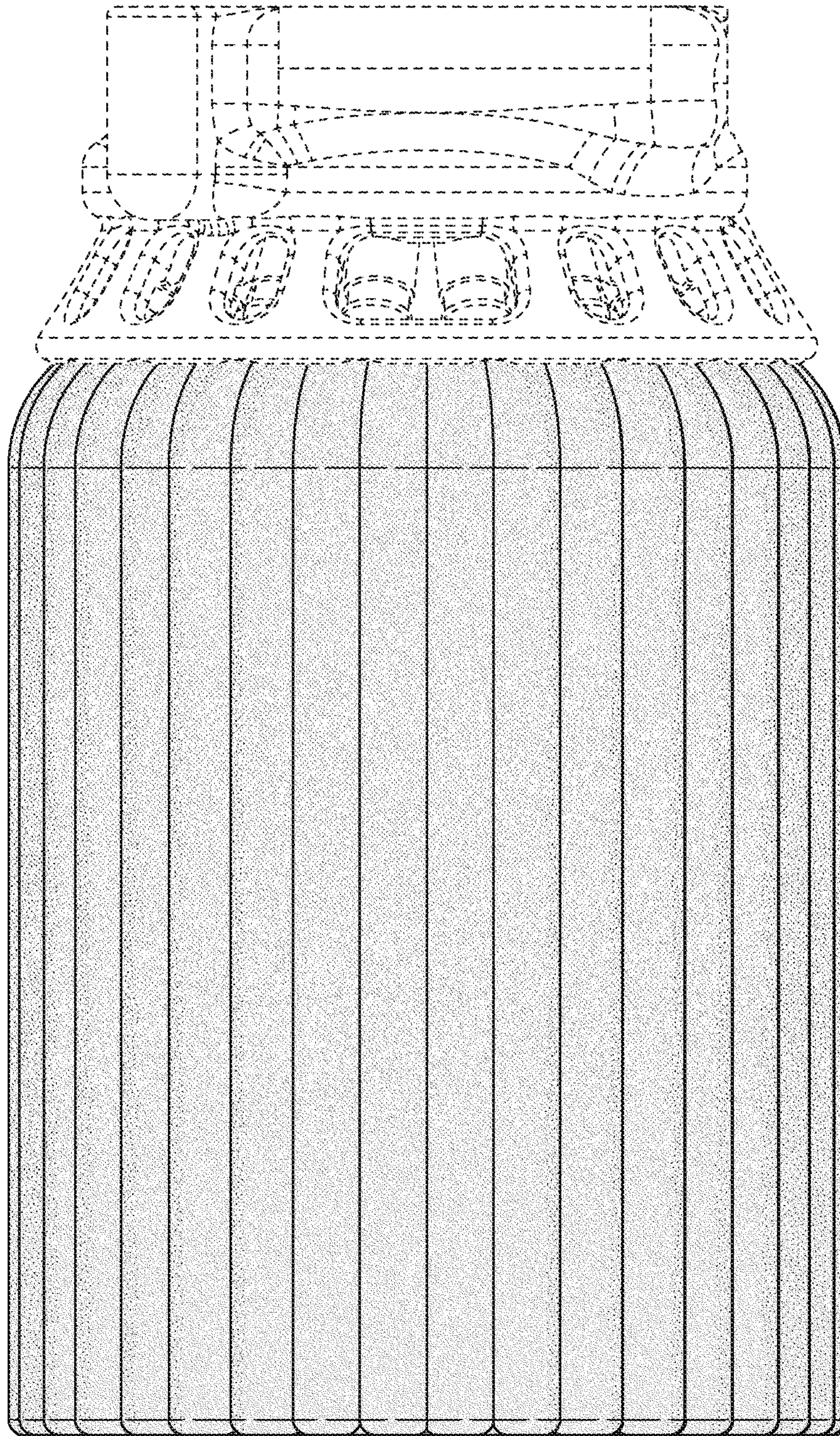

FIG. 22

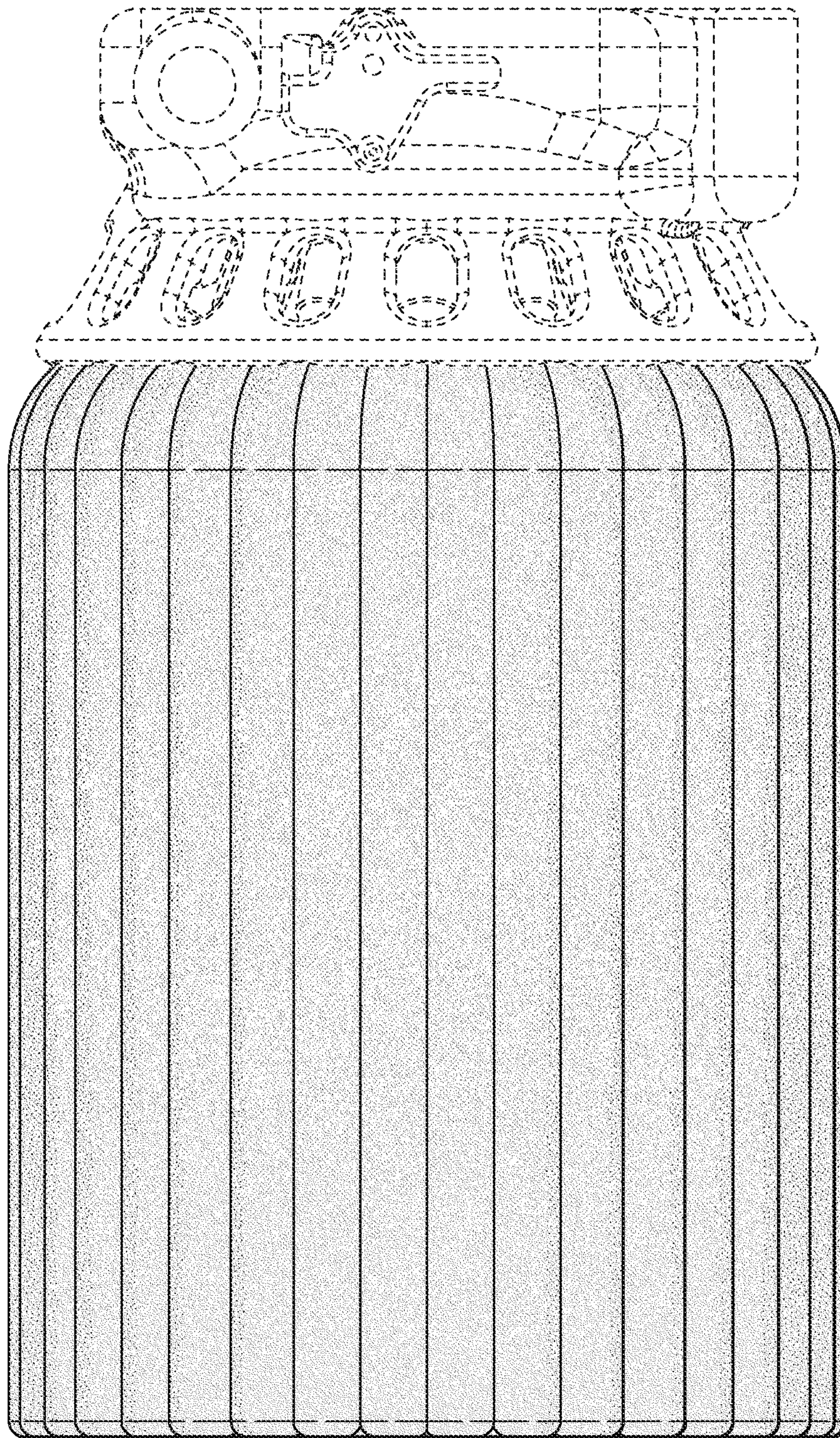

FIG. 23

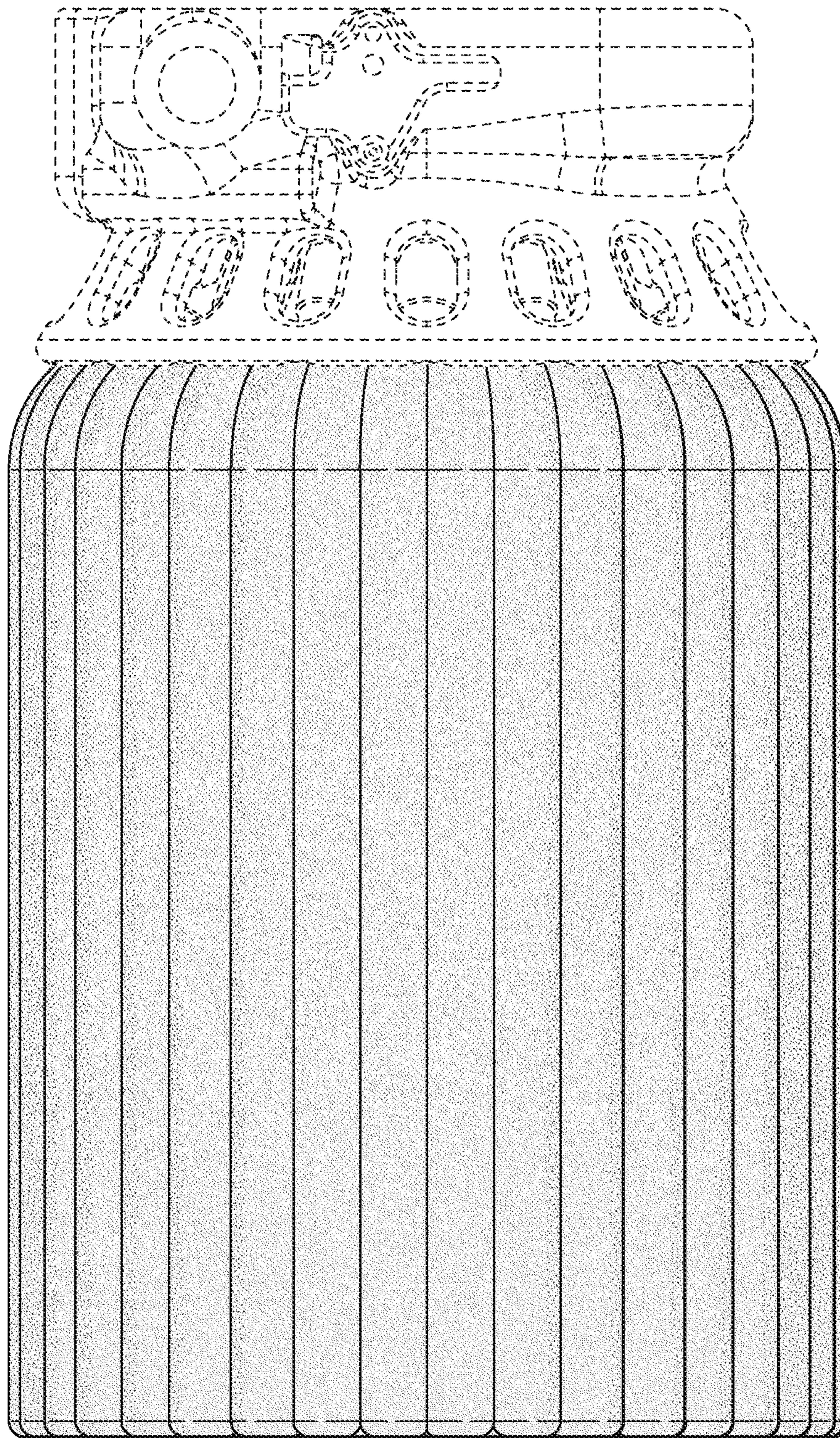

FIG. 24



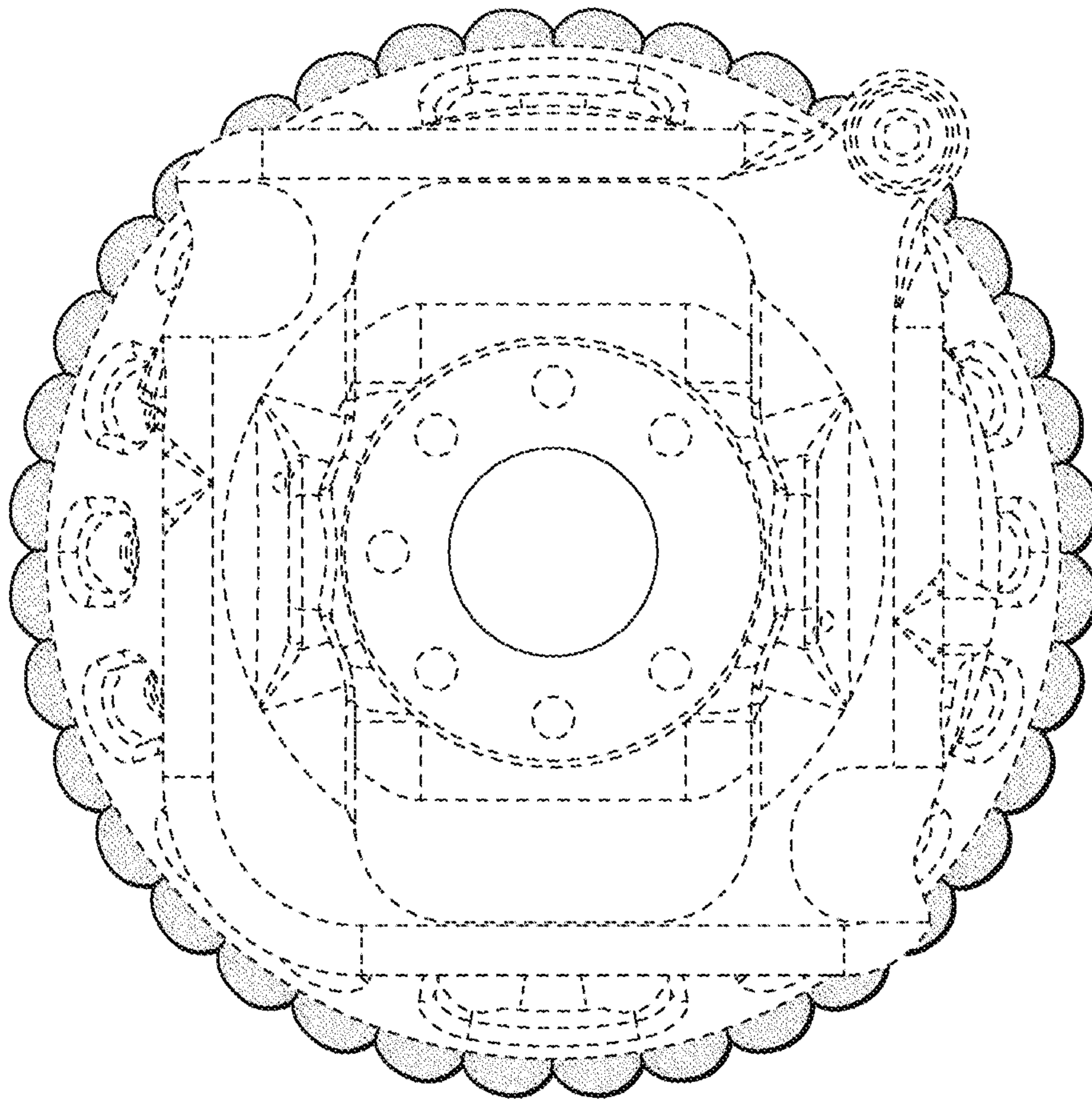

FIG. 25

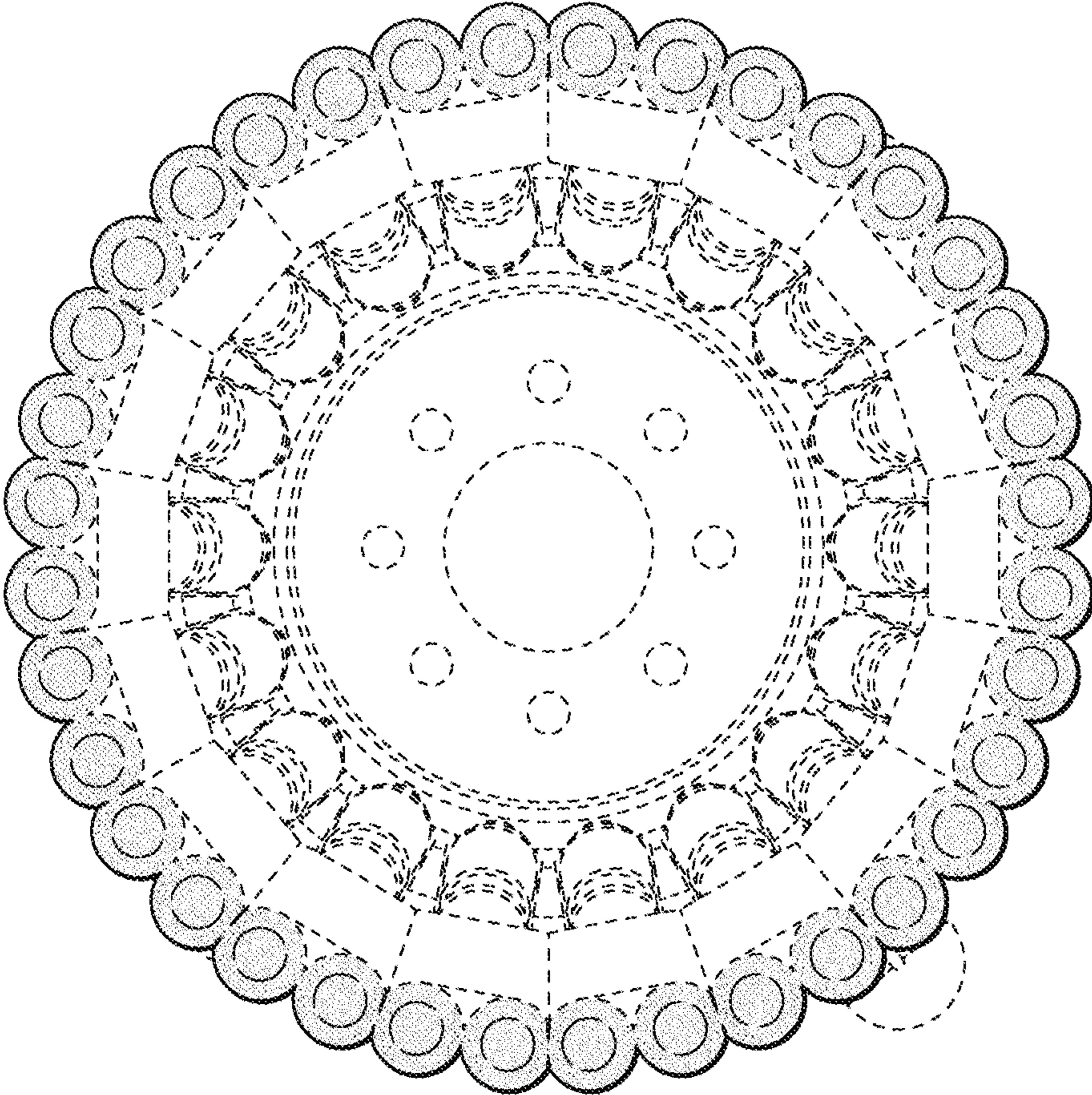

FIG. 26

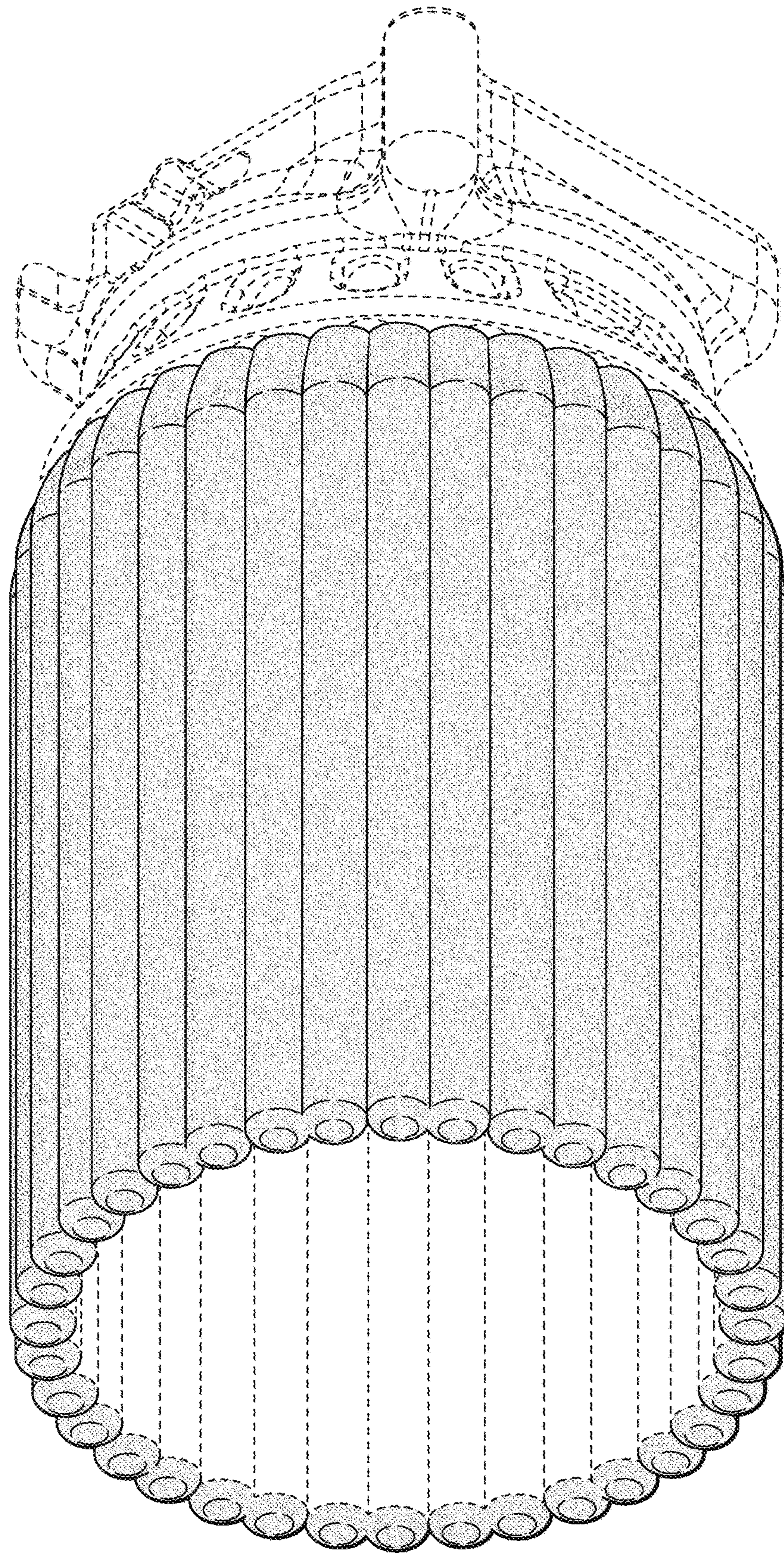

FIG. 27