

US00D873871S

(12) **United States Design Patent**
Kim et al.

(10) **Patent No.:** **US D873,871 S**
(45) **Date of Patent:** **** Jan. 28, 2020**

(54) **MAIN BODY FOR REFRIGERATOR**

F25D 27/005; F25D 23/12; F25D 29/005;
F25D 17/042; F25D 2325/021

(71) Applicant: **LG ELECTRONICS INC.**, Seoul
(KR)

See application file for complete search history.

(72) Inventors: **Minsub Kim**, Seoul (KR); **Sookyung Kang**, Seoul (KR); **Hyunki Kim**, Seoul (KR); **Taehyun Sung**, Seoul (KR); **Kyukwan Choi**, Seoul (KR); **Sungkyong Han**, Seoul (KR)

(56) **References Cited**

U.S. PATENT DOCUMENTS

D518,077	S	*	3/2006	Lee	D15/91
D553,167	S	*	10/2007	Busalt	D15/91
D562,362	S	*	2/2008	Bissig	D15/91
D567,262	S	*	4/2008	Crookshanks	D15/91
D577,373	S	*	9/2008	Crookshanks	D15/91
D642,600	S	*	8/2011	Kristiansen	D15/86
D646,308	S	*	10/2011	Kristiansen	D15/91
D674,416	S	*	1/2013	Seo	D15/86
D680,138	S	*	4/2013	Seo	D15/86
D681,695	S	*	5/2013	Lee	D15/86
D684,609	S	*	6/2013	Seo	D15/86
D686,254	S	*	7/2013	Wang	D15/91
D689,104	S	*	9/2013	Yang	D15/91
D706,315	S	*	6/2014	Seo	D15/89
D707,734	S	*	6/2014	Seo	D15/86
D709,925	S	*	7/2014	Seo	D15/89

(Continued)

(73) Assignee: **LG ELECTRONICS INC.**, Seoul
(KR)

(**) Term: **15 Years**

(21) Appl. No.: **35/505,530**

(22) Filed: **Feb. 23, 2018**

(80) **Hague Agreement Data**

Int. Filing Date: **Feb. 23, 2018**

Int. Reg. No.: **DM/100131**

Int. Reg. Date: **Feb. 23, 2018**

Int. Reg. Pub. Date: **Aug. 24, 2018**

Primary Examiner — Richard E Chilcot

(74) *Attorney, Agent, or Firm* — Birch, Stewart, Kolasch & Birch, LLP

(57) **CLAIM**

The ornamental design for a main body for refrigerator, as shown and described.

(30) **Foreign Application Priority Data**

Aug. 25, 2017 (KR) 30-2017-0039831

(51) **LOC (12) Cl.** **15-07**

(52) **U.S. Cl.**
USPC **D15/89**
CPC **F25D 11/00** (2013.01)

(58) **Field of Classification Search**
USPC D15/79-91
CPC F25D 2323/021; F25D 11/00; F25D 2323/024; F25D 23/04; F25D 25/024;

DESCRIPTION

1. Main body for refrigerator
- 1.1 : Perspective
- 1.2 : Front
- 1.3 : Back
- 1.4 : Left
- 1.5 : Right
- 1.6 : Top
- 1.7 : Bottom
- 1.8 : Enlarged
- 1.9 : Enlarged view 2

(Continued)

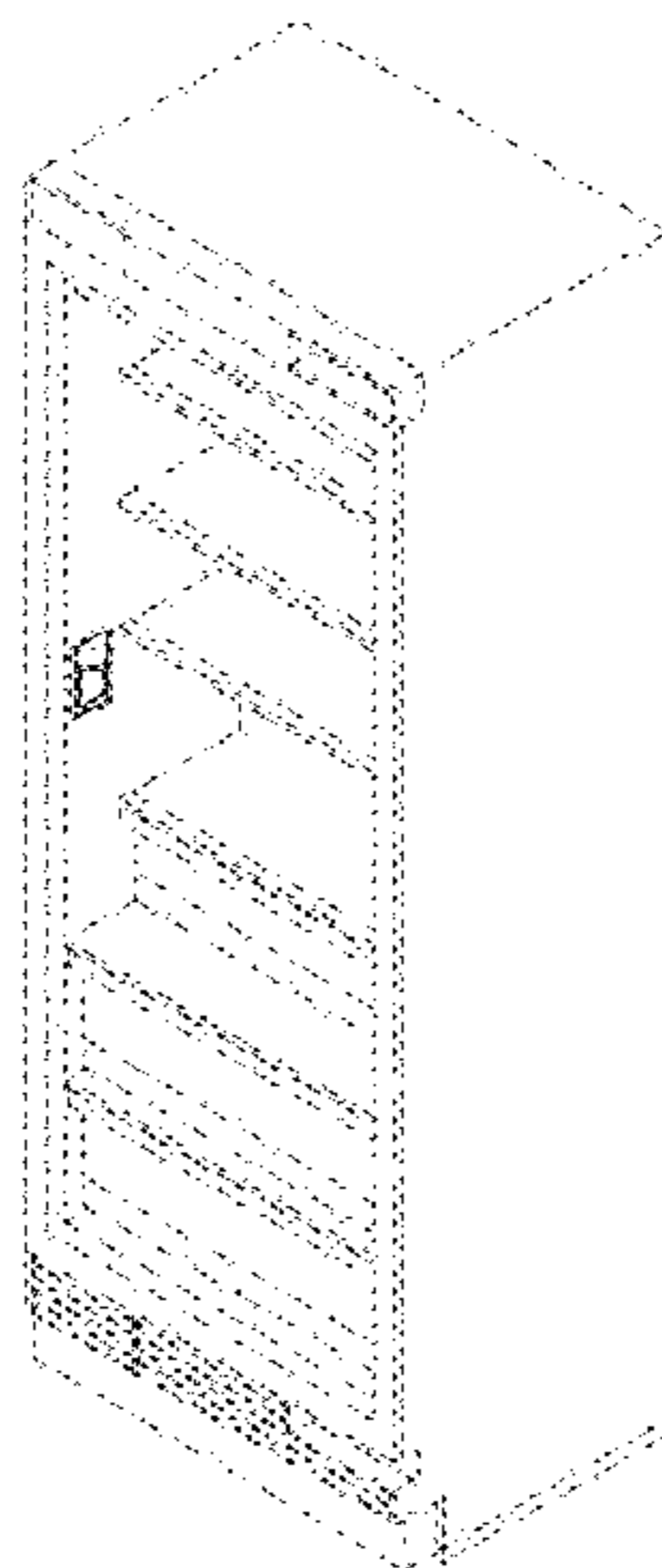

This design is for a main body for refrigerator with water dispenser at the inner side wall; the broken lines depict portions of the main body for refrigerator that form no part of the claimed design; the dash-dot broken lines define the boundary of the claimed design and form no part thereof.

1 Claim, 9 Drawing Sheets

(56)

References Cited

U.S. PATENT DOCUMENTS

D710,403 S * 8/2014 Seo D15/89
 D713,862 S * 9/2014 Lee D15/86
 D714,360 S * 9/2014 Seo D15/85
 D714,361 S * 9/2014 Seo D15/86
 D722,624 S * 2/2015 Cho D15/89
 D722,625 S * 2/2015 Cho D15/89
 D723,595 S * 3/2015 You D15/91
 D724,113 S * 3/2015 Seo D15/85
 D730,958 S * 6/2015 Choi D15/91
 D742,431 S * 11/2015 Seo D15/86
 D742,437 S * 11/2015 Choi D15/91
 D742,438 S * 11/2015 Jeon D15/91
 D744,551 S * 12/2015 Park D15/91
 D747,368 S * 1/2016 Kim D15/85
 D757,131 S * 5/2016 Lee D15/91
 D759,132 S * 6/2016 Kwon D15/91
 D760,819 S * 7/2016 Lee D15/86
 D760,820 S * 7/2016 Lee D15/91

D760,821 S * 7/2016 Lee D15/91
 D760,822 S * 7/2016 Lee D15/91
 D760,823 S * 7/2016 Lee D15/91
 D760,824 S * 7/2016 Lee D15/91
 D761,333 S * 7/2016 Lee D15/86
 D761,334 S * 7/2016 Lee D15/86
 D761,336 S * 7/2016 Lee D15/91
 D761,887 S * 7/2016 Seo D15/89
 D762,249 S * 7/2016 Kim D15/86
 D763,329 S * 8/2016 Seo D15/89
 D765,151 S * 8/2016 Park D15/81
 D766,344 S * 9/2016 Kim D15/86
 D767,648 S * 9/2016 Shoemaker D15/86
 D768,738 S * 10/2016 Lee D15/91
 D768,739 S * 10/2016 Lee D15/91
 D775,674 S * 1/2017 Seo D15/86
 D776,173 S * 1/2017 Kim D15/91
 D787,566 S * 5/2017 Seo D15/85
 D787,572 S * 5/2017 Seo D15/91
 D788,187 S * 5/2017 Kim D15/84
 D788,188 S * 5/2017 Seo D15/86
 D788,193 S * 5/2017 Seo D15/91
 D788,194 S * 5/2017 Kwak D15/91
 D788,828 S * 6/2017 Seo D15/86
 D816,737 S * 5/2018 Kim D15/91
 D817,367 S * 5/2018 Kim D15/91
 D818,011 S * 5/2018 Kim D15/91
 D818,012 S * 5/2018 Kim D15/91
 D841,700 S * 2/2019 Lee D15/91
 2010/0242526 A1 * 9/2010 Junge F25D 17/065
 62/449
 2014/0117830 A1 * 5/2014 Lee F25D 25/025
 312/402

* cited by examiner

1.1

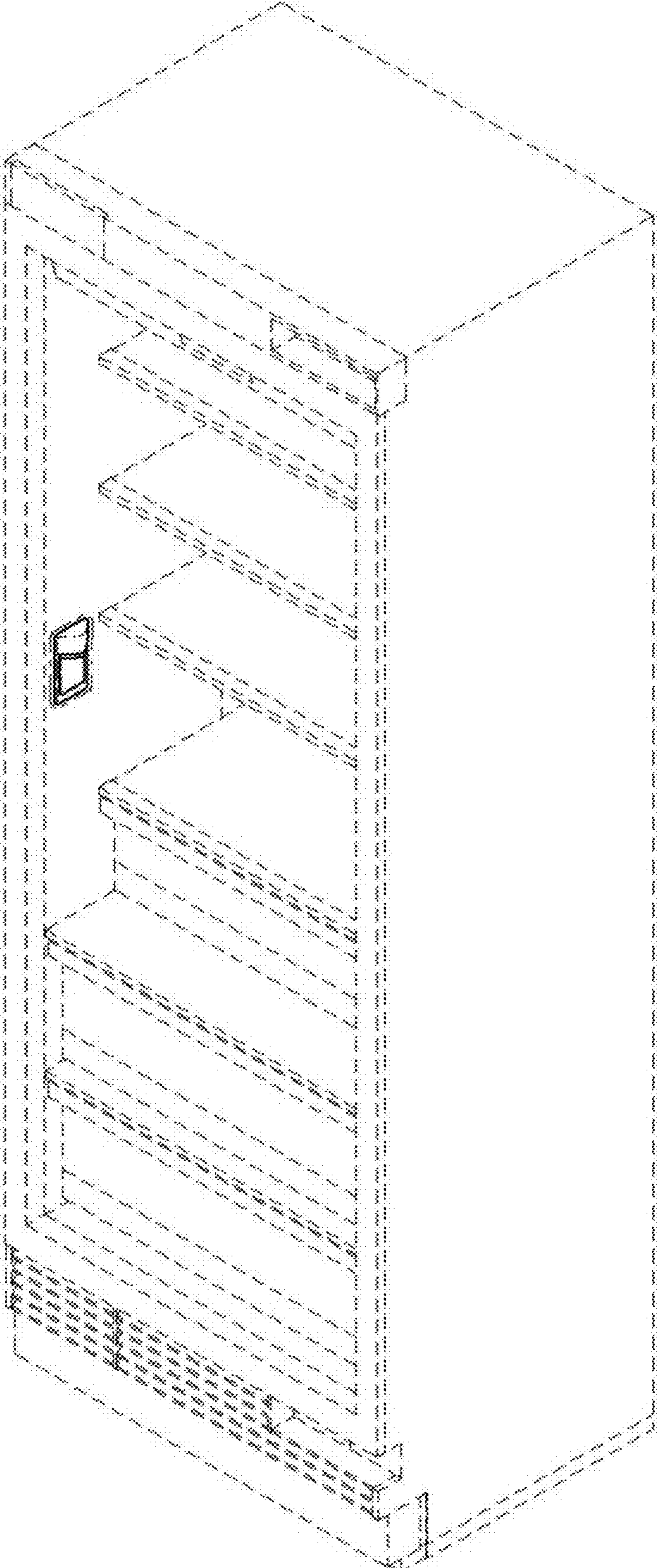

1.2

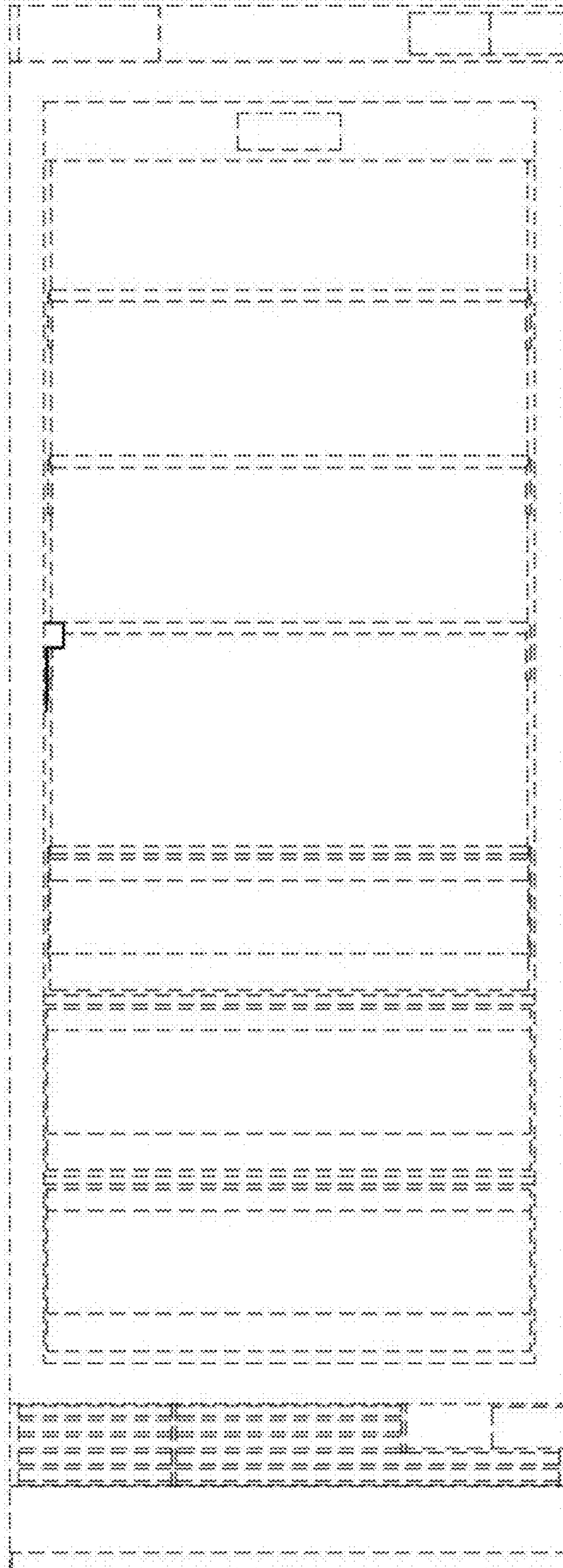

1.3

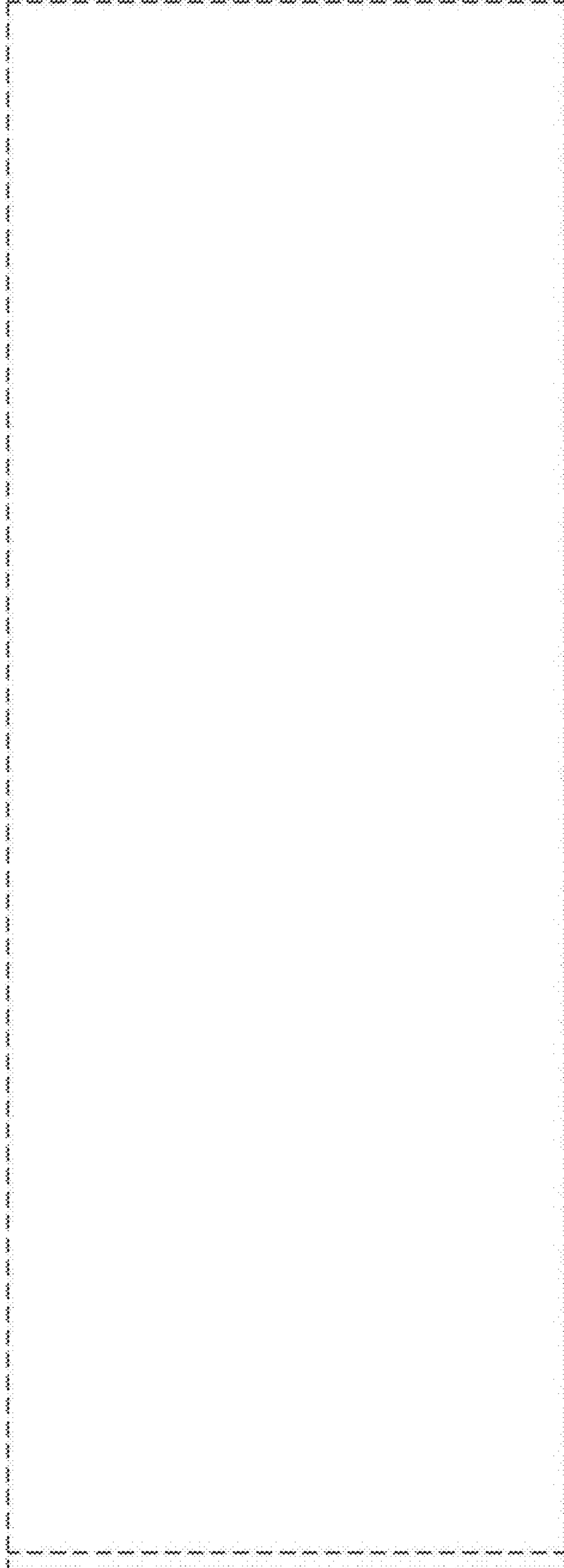

1.4

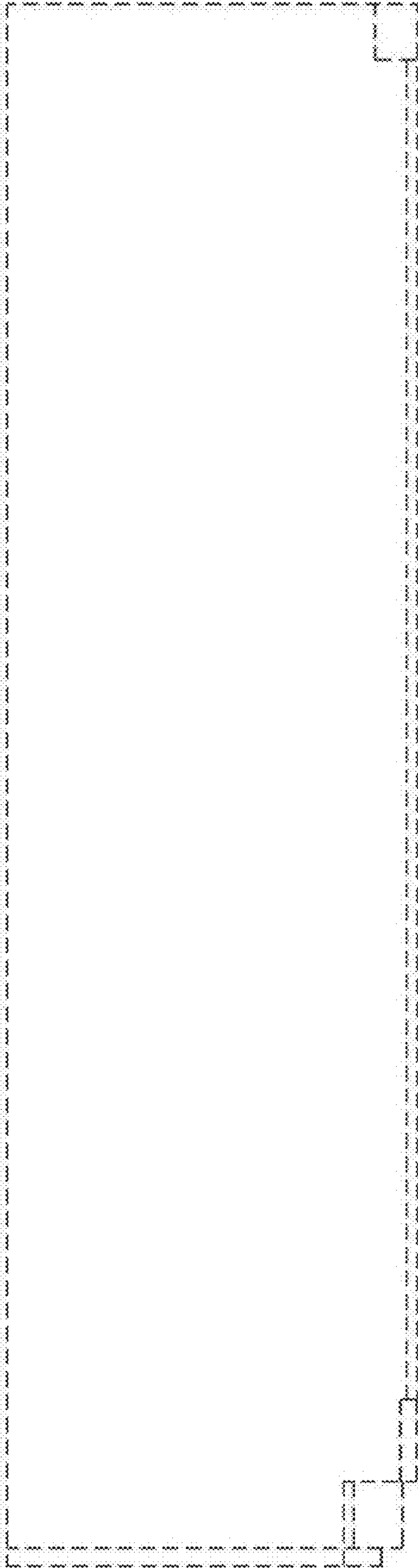

1.5

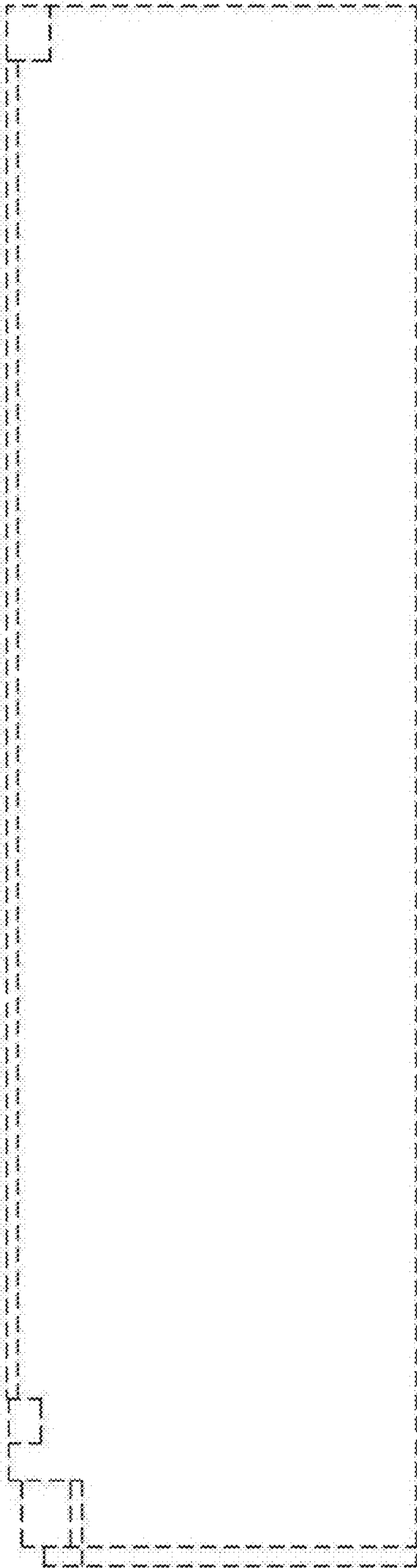

1.6



1.7

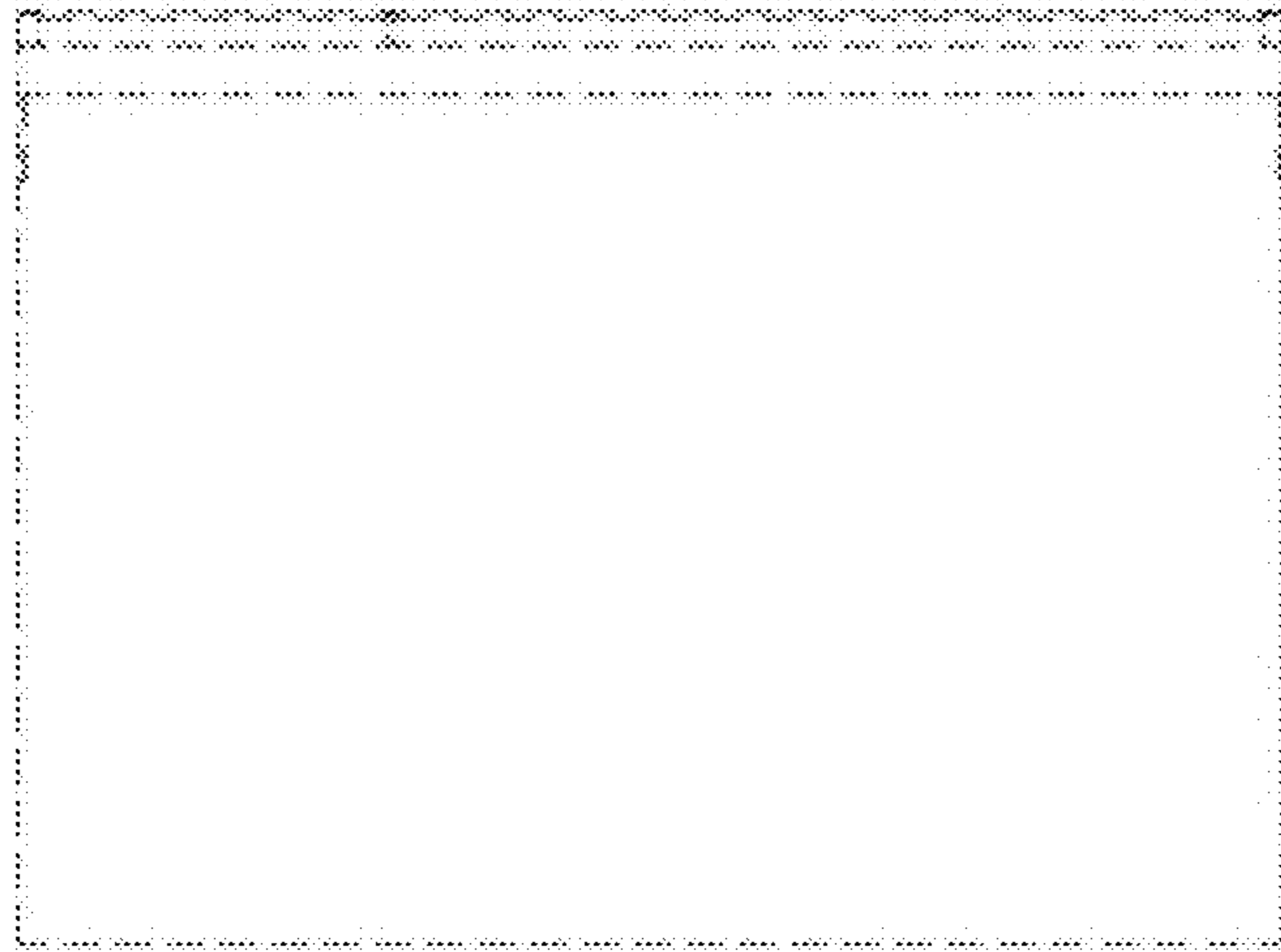

1.8

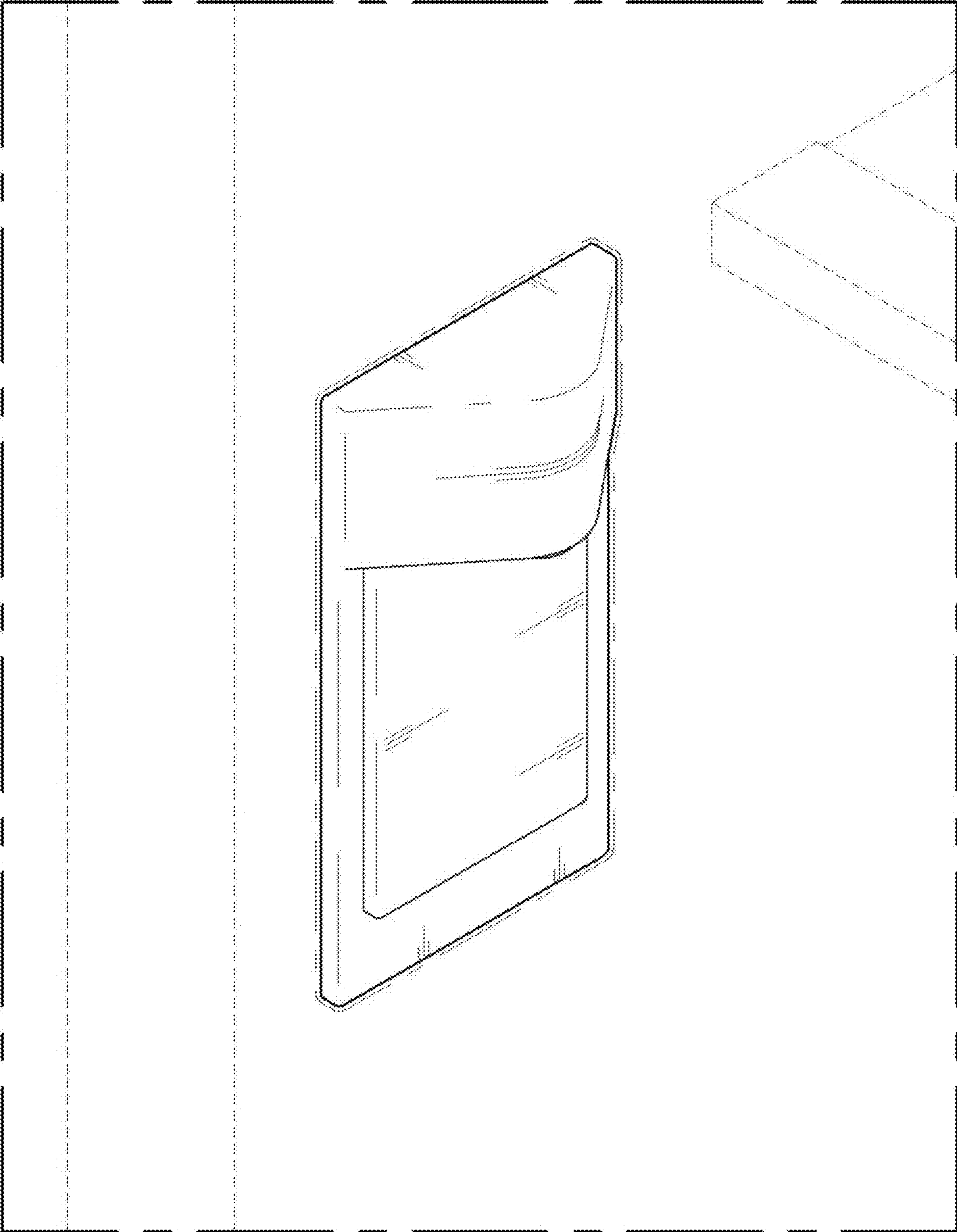

1.9

