



US00D873832S

(12) **United States Design Patent** (10) **Patent No.:** **US D873,832 S**
Akana et al. (45) **Date of Patent:** **** Jan. 28, 2020**

(54) **DISPLAY FOR AN ELECTRONIC DEVICE**

(71) Applicant: **Apple Inc.**, Cupertino, CA (US)

(72) Inventors: **Jody Akana**, San Francisco, CA (US);
Bartley K. Andre, Palo Alto, CA (US);
Shota Aoyagi, San Francisco, CA (US);
Jeremy Bataillou, San Francisco, CA (US);
Daniel J. Coster, San Francisco, CA (US);
Daniele De Iuliis, San Francisco, CA (US);
M. Evans Hankey, San Francisco, CA (US);
Matthew David Hill, Santa Clara, CA (US);
Julian Hoenig, San Francisco, CA (US);
Richard P. Howarth, San Francisco, CA (US);
Jonathan P. Ive, San Francisco, CA (US);
Duncan Robert Kerr, San Francisco, CA (US);
Jared Kole, San Francisco, CA (US);
Stefan Mag, San Francisco, CA (US);
Nicholas George LeBreton Merz, San Francisco, CA (US);
Scott A. Myers, San Francisco, CA (US);
Benjamin J. Pope, Sunnyvale, CA (US);
Matthew Rao, San Francisco, CA (US);
Matthew Dean Rohrbach, San Francisco, CA (US);
Peter Russell-Clarke, San Francisco, CA (US);
Mikael Silvano, San Francisco, CA (US);
Christopher J. Stringer, Woodside, CA (US);
Tang Yew Tan, San Francisco, CA (US);
Eugene Antony Whang, San Francisco, CA (US);
Rico Zörkendörfer, San Francisco, CA (US)

(73) Assignee: **Apple Inc.**, Cupertino, CA (US)

(**) Term: **15 Years**

(21) Appl. No.: **29/575,610**

(22) Filed: **Aug. 26, 2016**

Related U.S. Application Data

(63) Continuation of application No. 29/466,601, filed on Sep. 10, 2013, now Pat. No. Des. 765,084.

(51) **LOC (12) Cl.** **14-02**

(52) **U.S. Cl.**
USPC **D14/439**

(58) **Field of Classification Search**

USPC D14/341-347, 420, 426, 129-130, 496,
D14/138, 138 G, 138 R, 138 AA, 138 AB,
D14/138 C, 139, 248, 203.1-203.8,
D14/388-390, 383, 384, 374, 381, 439,
D14/140-142, 356, 257, 299, 358, 137,
D14/240; D10/104.4, 65; D21/324, 329,
D21/332

CPC G06F 1/1626; G06F 1/1613; G06F
2200/1633; G06F 3/0488; G06F 3/04886;
G06F 3/044; G06F 3/0412; G06F 3/0416;
H04B 1/3833

See application file for complete search history.

(56) **References Cited**

U.S. PATENT DOCUMENTS

D304,448 S	11/1989	De La Cruz et al.
D455,433 S	4/2002	Alviar et al.
D489,071 S	4/2004	Nishioka et al.
D489,072 S	4/2004	Nishioka et al.
D489,073 S	4/2004	Nishioka et al.
D489,074 S	4/2004	Nishioka et al.
D500,037 S	12/2004	Ozolins et al.
D504,889 S	5/2005	Andre et al.
6,900,388 B2	5/2005	Wang et al.
D513,617 S	1/2006	Tierney
7,236,357 B2	6/2007	Chen
D557,239 S	12/2007	Lee
7,303,424 B2	12/2007	Tu et al.
D558,756 S	1/2008	Andre et al.
D558,757 S	1/2008	Andre et al.
D558,758 S	1/2008	Andre et al.
D561,153 S	2/2008	Hong et al.
D563,432 S	3/2008	Kim
D569,830 S	5/2008	Kwak
D570,346 S	6/2008	Suk et al.
D574,819 S	8/2008	Andre et al.
D575,259 S	8/2008	Kim et al.
D580,387 S	11/2008	Andre et al.
D581,922 S	12/2008	Andre et al.
D592,211 S	5/2009	Ichise et al.
D592,212 S	5/2009	Hamada et al.
D593,087 S	5/2009	Andre et al.
D594,863 S	6/2009	Ichise et al.
D599,342 S	9/2009	Andre et al.
D600,241 S	9/2009	Andre et al.
D600,690 S	9/2009	Miyaji
D602,014 S	10/2009	Andre et al.

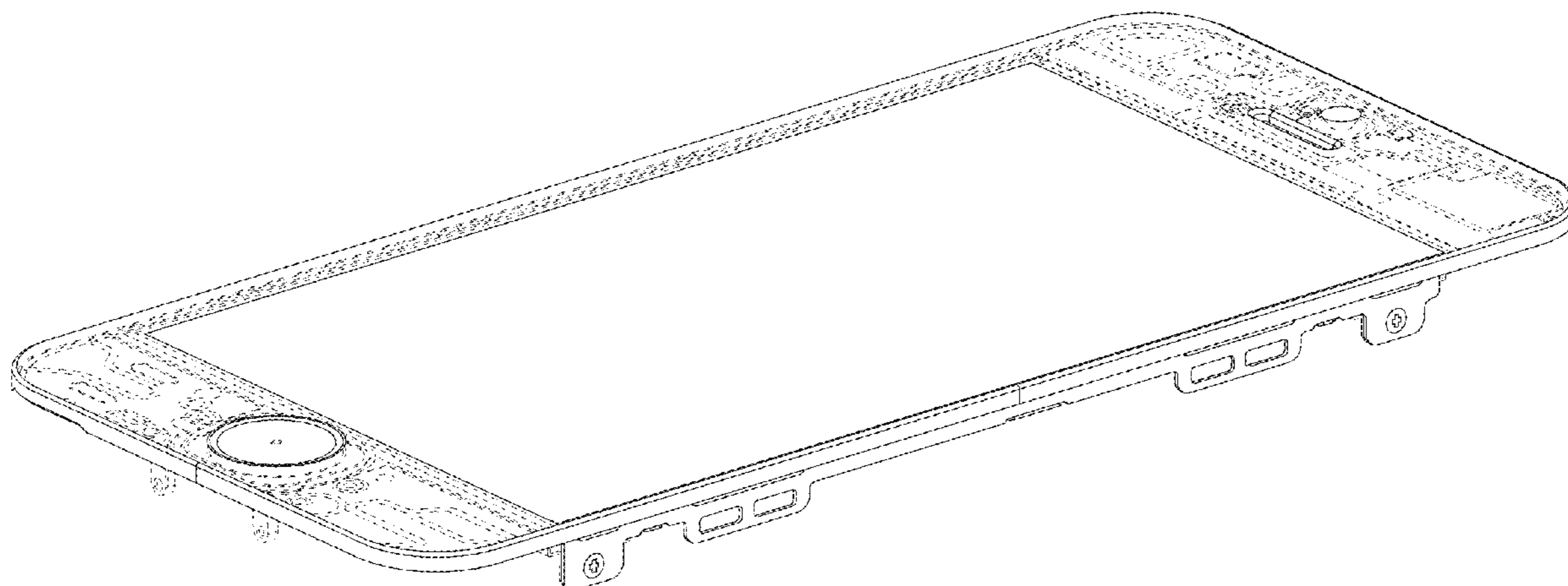

US D873,832 S

D602,015 S	10/2009	Andre et al.	D653,640 S	2/2012	Kwon et al.
D602,016 S	10/2009	Andre et al.	D653,642 S	2/2012	Han
D602,017 S	10/2009	Andre et al.	D654,461 S	2/2012	Kim et al.
D602,486 S	10/2009	Andre et al.	8,116,073 B2	2/2012	Hung et al.
D602,488 S	10/2009	Jiang et al.	D657,764 S	4/2012	Hong
D604,297 S	11/2009	Andre et al.	D657,782 S	4/2012	Biller
D606,129 S	12/2009	Ben-Moshe	D658,147 S	4/2012	Yoon
7,660,560 B2	2/2010	Zuo et al.	D658,148 S	4/2012	Park et al.
D613,735 S	4/2010	Andre et al.	D661,707 S	6/2012	Akana et al.
D613,736 S	4/2010	Andre et al.	D662,922 S	7/2012	Akana et al.
7,697,281 B2	4/2010	Dabov et al.	D666,202 S	8/2012	Dinh et al.
D615,083 S	5/2010	Andre et al.	8,264,837 B2	9/2012	Pakula et al.
D616,875 S	6/2010	Oh et al.	D669,071 S	10/2012	Akana et al.
D617,792 S	6/2010	Andre et al.	D672,343 S	12/2012	Akana et al.
D618,677 S	6/2010	Andre et al.	D673,948 S	1/2013	Andre et al.
D618,678 S	6/2010	Andre et al.	D674,383 S	1/2013	Andre et al.
D619,361 S	7/2010	Andre et al.	D675,202 S	1/2013	Andre et al.
D621,807 S	8/2010	Stone	D677,657 S	3/2013	Akana et al.
D622,270 S	8/2010	Andre et al.	D677,666 S	3/2013	Akana et al.
D622,718 S	8/2010	Andre et al.	D678,261 S	3/2013	Akana et al.
D622,719 S	8/2010	Andre et al.	D681,032 S	4/2013	Akana et al.
D622,720 S	8/2010	Andre et al.	D684,571 S	6/2013	Akana et al.
D623,183 S	9/2010	Hong et al.	D689,475 S	9/2013	Andre et al.
D624,304 S	9/2010	Danze et al.	D692,878 S	11/2013	Akana et al.
D624,536 S	9/2010	Andre et al.	D692,879 S	11/2013	Andre et al.
D625,303 S	10/2010	Kim	D695,316 S	12/2013	Akana et al.
D625,307 S	10/2010	Cheng	D697,511 S	1/2014	Andre et al.
D626,937 S	11/2010	Yeo et al.	D699,717 S	2/2014	Akana et al.
D627,777 S	11/2010	Akana et al.	D703,633 S	4/2014	Akana et al.
D627,778 S	11/2010	Akana et al.	8,684,613 B2	4/2014	Weber
D629,387 S	12/2010	Lee	D706,253 S	6/2014	Simmer
D629,772 S	12/2010	Mo et al.	D707,223 S	6/2014	Akana et al.
D629,787 S	12/2010	Lee	D707,648 S	6/2014	Ryu et al.
D629,788 S	12/2010	Lee	D710,814 S	8/2014	Im
D629,799 S	12/2010	Andre et al.	D710,843 S	8/2014	Akana et al.
D630,630 S	1/2011	Andre et al.	D714,053 S	9/2014	Yoo
7,869,206 B2	1/2011	Dabov et al.	D714,294 S	9/2014	Dinh et al.
7,876,274 B2	1/2011	Hobson et al.	D714,771 S	10/2014	Rayner
D630,090 S	2/2011	Andre et al.	D716,780 S	11/2014	Park
D633,090 S	2/2011	Andre et al.	D716,781 S	11/2014	Andre et al.
D633,091 S	2/2011	Andre et al.	D728,545 S	5/2015	Koh
7,889,139 B2	2/2011	Hobson et al.	D731,481 S	6/2015	Akana et al.
D633,460 S	3/2011	Yi et al.	D732,040 S	6/2015	Chuang et al.
D633,493 S	3/2011	Akana et al.	D732,540 S	6/2015	Kang et al.
D633,908 S	3/2011	Akana et al.	D735,175 S	7/2015	Liu et al.
D634,319 S	3/2011	Andre et al.	D735,176 S	7/2015	Liu et al.
D634,742 S	3/2011	Andre et al.	D743,391 S	11/2015	Akana et al.
D636,390 S	4/2011	Andre et al.	D747,319 S *	1/2016	Lee D14/439
D636,392 S	4/2011	Akana et al.	D748,062 S	1/2016	Akana et al.
7,924,231 B2	4/2011	Hill et al.	D749,563 S	2/2016	Akana et al.
7,933,123 B2	4/2011	Wang et al.	D749,590 S	2/2016	Dinh et al.
D637,596 S	5/2011	Akana et al.	D751,559 S	3/2016	Babiarz et al.
D638,814 S	5/2011	Sutherland et al.	D759,008 S	6/2016	Akana et al.
D638,835 S	5/2011	Akana et al.	D764,434 S *	8/2016	Akana D14/203.7
D639,261 S	6/2011	Garnham et al.	D769,830 S *	10/2016	Clymer D13/168
D639,805 S	6/2011	Song et al.	9,465,476 B1 *	10/2016	Malek G06F 1/1656
D640,219 S	6/2011	Sutherland et al.	D771,025 S *	11/2016	Lee D14/248
D640,578 S	6/2011	Aihara et al.	D777,714 S *	1/2017	Akana D14/250
D640,646 S	6/2011	Wu et al.	D794,005 S *	8/2017	Kwon D14/248
D640,661 S	6/2011	Hu et al.	D796,496 S *	9/2017	Lee D14/248
D640,663 S	6/2011	Arnholt et al.	D804,464 S *	12/2017	Lamb D14/250
D642,151 S	7/2011	Chun et al.	D812,062 S *	3/2018	MacDonald D14/432
D642,563 S	8/2011	Akana et al.	D817,314 S *	5/2018	Kwon D14/248
D644,194 S	8/2011	Joung et al.	D818,444 S *	5/2018	Clymer D13/168
D644,218 S	8/2011	Akana et al.	D820,222 S *	6/2018	Clymer D13/168
D645,833 S	9/2011	Seflic et al.	D824,389 S *	7/2018	Dinh D14/439
8,014,135 B2	9/2011	Yu	D824,390 S *	7/2018	Akana D14/439
D647,106 S	10/2011	Akana et al.	D832,266 S *	10/2018	Akana D14/439
D647,519 S	10/2011	Rothbaum et al.	D852,195 S *	6/2019	Aoyagi D14/439
D647,882 S	11/2011	Kim et al.	D854,000 S *	7/2019	Akana D14/248
D648,704 S	11/2011	Hofer et al.	D856,338 S *	8/2019	Akana D14/439
D649,150 S	11/2011	Takahashi et al.	2006/0139856 A1	6/2006	Liu et al.
D649,526 S	11/2011	Hu	2006/0160411 A1	7/2006	Lai et al.
D649,539 S	11/2011	Hong	2006/0281501 A1	12/2006	Zuo et al.
D651,606 S	1/2012	Luijben	2007/0082718 A1	4/2007	Yoon et al.
D652,015 S	1/2012	Han	2008/0316116 A1	12/2008	Hobson et al.
D652,814 S	1/2012	Choi et al.	2008/0316121 A1	12/2008	Hobson et al.
8,102,319 B2	1/2012	Schlub et al.	2009/0067141 A1	3/2009	Dabov et al.
8,106,836 B2	1/2012	Hill et al.	2009/0245565 A1	10/2009	Mittleman et al.

2009/0247244	A1	10/2009	Mittleman et al.	
2010/0105452	A1	4/2010	Shin et al.	
2010/0277877	A1	11/2010	Dinh et al.	
2011/0151945	A1	6/2011	Jiang et al.	
2011/0164365	A1	7/2011	McClure et al.	
2011/0164370	A1	7/2011	McClure et al.	
2011/0188179	A1	8/2011	Myers et al.	
2011/0216486	A1	9/2011	Ho et al.	
2011/0255218	A1	10/2011	Pakula et al.	
2012/0002352	A1	1/2012	Hsiung	
2012/0009974	A1	1/2012	Sunderland	
2012/0044123	A1	2/2012	Rothkopf et al.	
2012/0044637	A1*	2/2012	Rothkopf	G06F 1/1626 361/679.55
2012/0050988	A1	3/2012	Rothkopf et al.	
2012/0051025	A1	3/2012	Jol et al.	
2012/0073115	A1	3/2012	Filson et al.	
2012/0086648	A1	4/2012	Leung	
2012/0087066	A1	4/2012	Leggett	
2012/0092812	A1	4/2012	Lewis et al.	
2013/0063876	A1*	3/2013	Pakula	G06F 1/1626 361/679.01
2013/0077282	A1*	3/2013	Malek	H05K 9/003 361/818
2013/0765965		3/2013	Dabov	
2013/0113348	A1	5/2013	Holben et al.	
2013/0175186	A1	7/2013	Simmer	

FOREIGN PATENT DOCUMENTS

JP	1351273	2/2009
JP	1474567	7/2013
JP	1481759	10/2013
JP	1496834	5/2014
TW	D136926	9/2010
TW	D137773	11/2010
TW	D139493	11/2011
TW	D147559	6/2012

OTHER PUBLICATIONS

iCracked iPhone 5S Screen Replacement Kit, announced Jan. 17, 2014 [online], [site visited Oct. 13, 2018]. Available from Internet,

URL: <<https://www.amazon.com/iCracked-iPhone-Screen-Replacement-White/dp/B00HUTGRKG>> (Year: 2014).*

U.S. Appl. No. 29/368,831, filed Aug. 30, 2010; Akana et al.
 U.S. Appl. No. 29/384,914, filed Feb. 4, 2011; Akana et al.
 U.S. Appl. No. 29/384,915, filed Feb. 4, 2011; Akana et al.
 U.S. Appl. No. 29/385,792, filed Feb. 18, 2011; Akana et al.
 U.S. Appl. No. 29/466,514, filed Sep. 9, 2013; Akana et al.
 U.S. Appl. No. 29/501,776, filed Sep. 8, 2014; Akana et al.
 U.S. Appl. No. 29/481,925, filed Feb. 12, 2014; Akana et al.

* cited by examiner

Primary Examiner — T Chase Nelson
Assistant Examiner — Dana K Weiland
 (74) *Attorney, Agent, or Firm* — Sterne, Kessler, Goldstein & Fox P.L.L.C.

(57) **CLAIM**

The ornamental design for a display for an electronic device, as shown and described.

DESCRIPTION

FIG. 1 is a bottom front perspective view of a display for an electronic device showing the claimed design;
 FIG. 2 is a front view thereof;
 FIG. 3 is a rear view thereof;
 FIG. 4 is a top view thereof;
 FIG. 5 is a bottom view thereof;
 FIG. 6 is a left view thereof; and,
 FIG. 7 is a right view thereof.
 The broken lines in the figures show portions of the display for an electronic device that form no part of the claimed design.

1 Claim, 7 Drawing Sheets

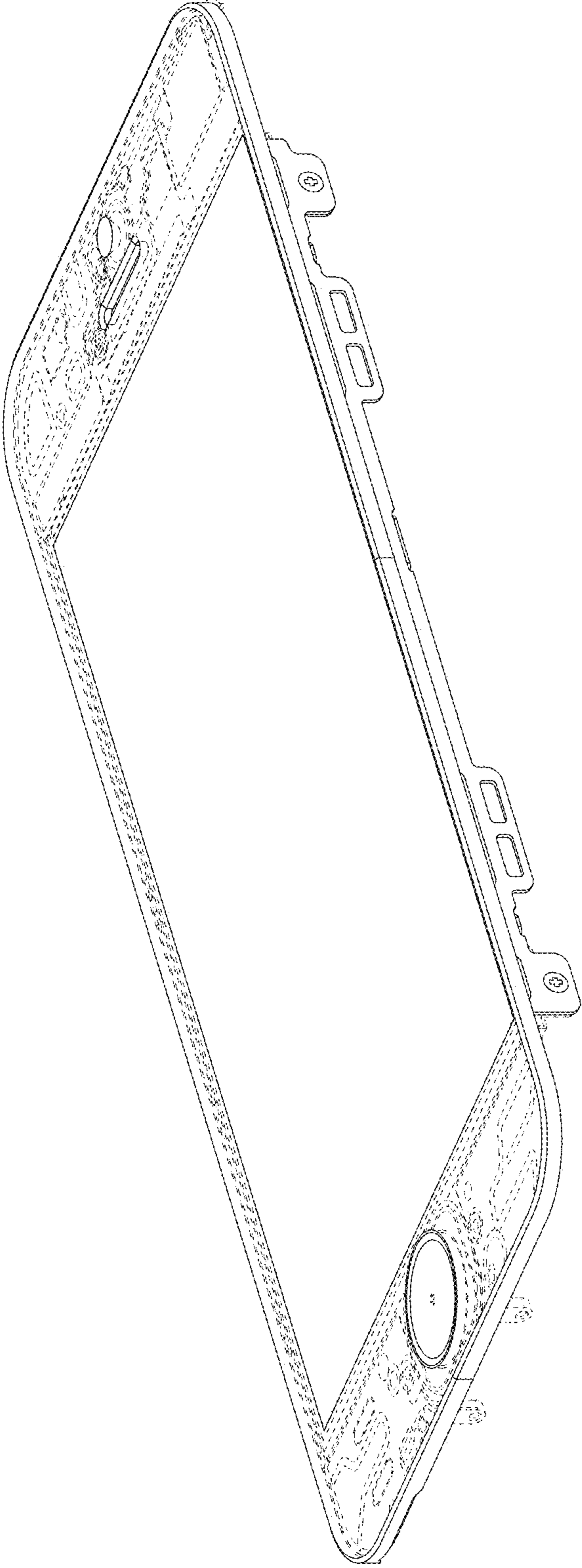

FIG. 1

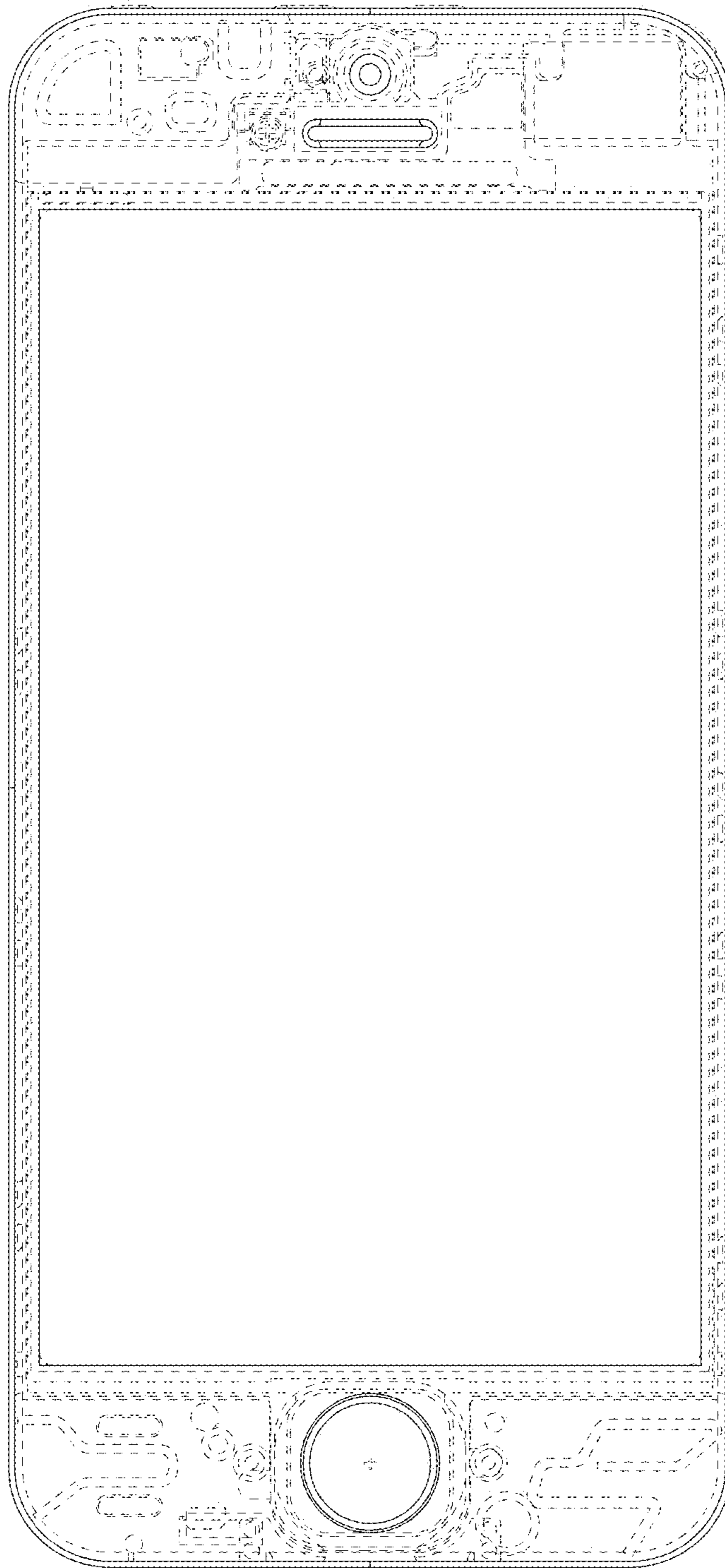

FIG. 2

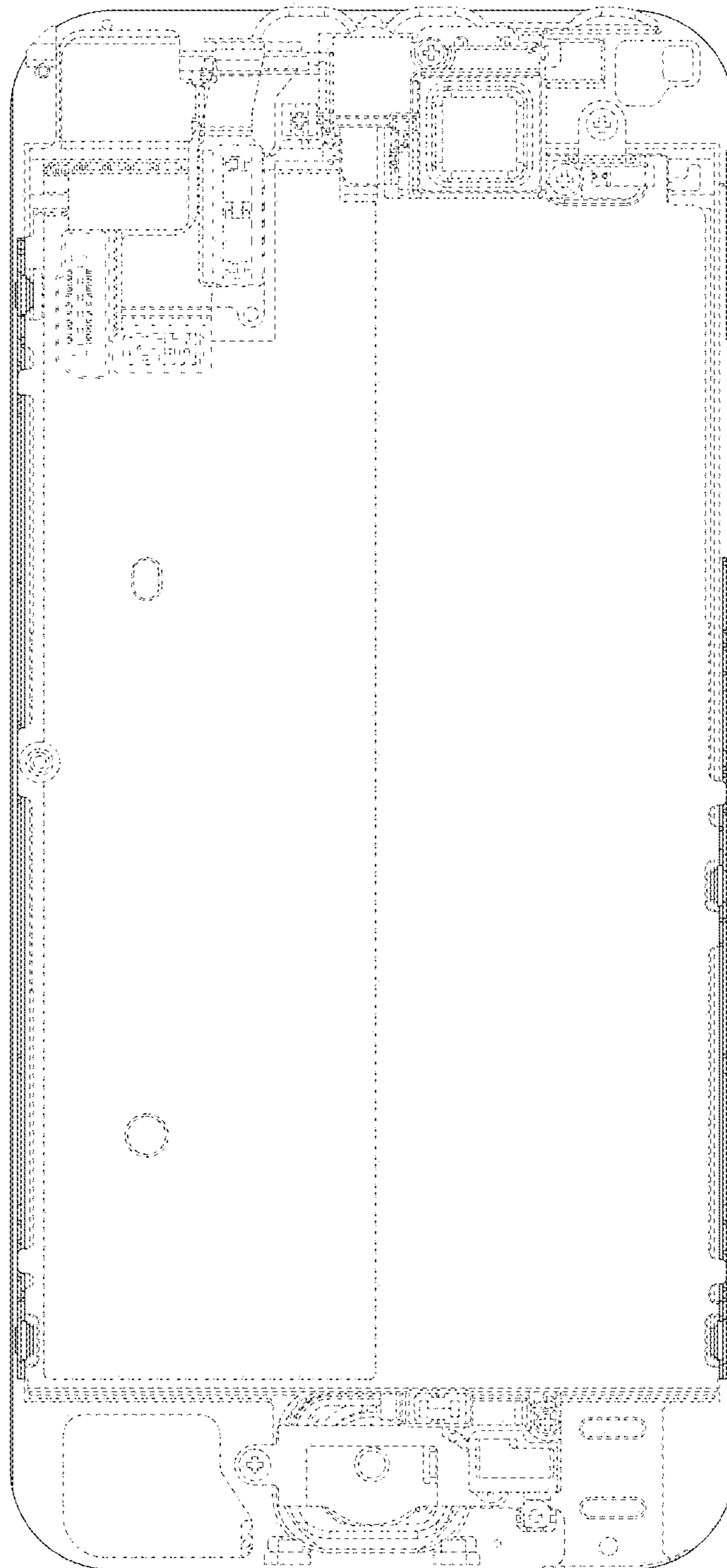

FIG. 3

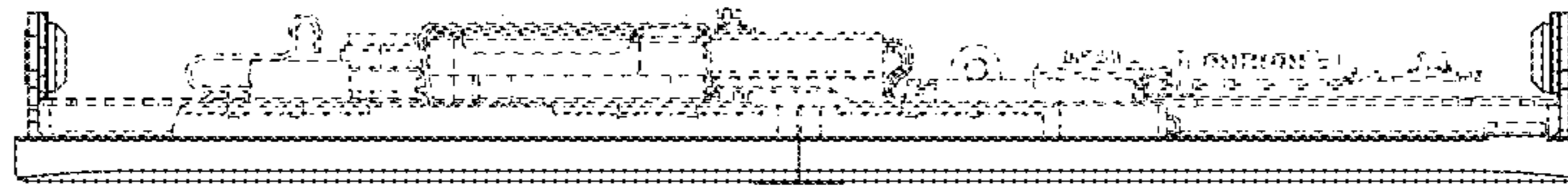

FIG. 4

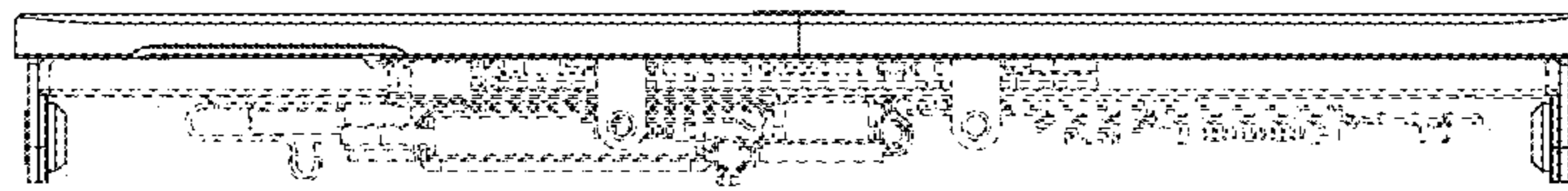

FIG. 5

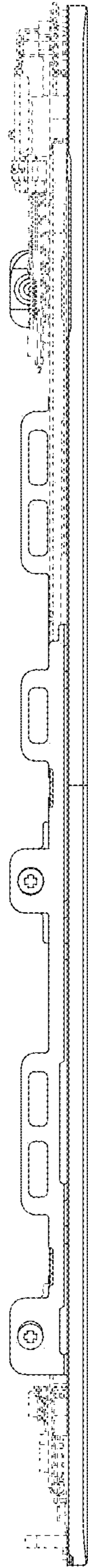

FIG. 6

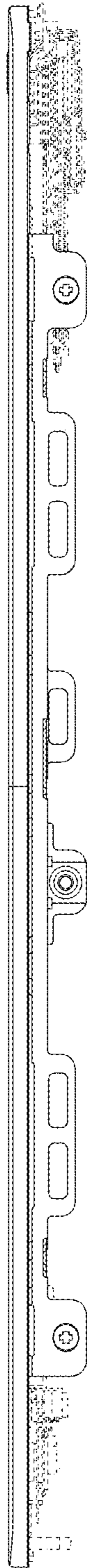

FIG. 7