

US00D873672S

(12) **United States Design Patent**
Park et al.

(10) **Patent No.:** **US D873,672 S**
(45) **Date of Patent:** **** Jan. 28, 2020**

- (54) **ATOMIZER FOR PERFUMES**
- (71) Applicant: **TONGIL POCKET CASE CO., LTD,**
Incheon (KR)
- (72) Inventors: **Nam Ju Park,** Siheung-si (KR); **Jae Sang Park,** Siheung-si (KR)
- (73) Assignee: **TONGIL POCKET CASE CO., LTD,**
Incheon (KR)
- (**) Term: **15 Years**
- (21) Appl. No.: **35/506,303**
- (22) Filed: **Jul. 12, 2018**
- (80) **Hague Agreement Data**
Int. Filing Date: **Jul. 12, 2018**
Int. Reg. No.: **DM/102239**
Int. Reg. Date: **Jul. 12, 2018**
Int. Reg. Pub. Date: **Jan. 18, 2019**

- D564,898 S * 3/2008 McGuinness D9/560
- D644,108 S * 8/2011 Vila Calvo D9/529
- D646,579 S * 10/2011 Rahe D9/560
- D655,200 S * 3/2012 Gross B65D 83/56
D9/687
- D675,104 S * 1/2013 Chen D9/687
- D684,673 S * 6/2013 Caroen D23/366
- D685,075 S * 6/2013 Abbondanzio D23/366
- D703,060 S * 4/2014 Okulla D28/76
- D707,559 S * 6/2014 Ordiway D9/448
- D725,483 S * 3/2015 Abadie D9/687
- D733,564 S * 7/2015 Sumida D9/529
- D736,999 S * 8/2015 Yiu D28/58
- D779,124 S * 2/2017 Houyoux D28/91.1
- 9,789,502 B2 * 10/2017 Maddy B05B 15/30
- D804,321 S * 12/2017 Zhao D9/686
- D824,094 S * 7/2018 Rein D27/141
- D833,079 S * 11/2018 Fang D28/91.1
- D851,497 S * 6/2019 Zhu D9/687
- D853,035 S * 7/2019 Moretti D28/76
- 2009/0294476 A1 * 12/2009 Koenig B05B 11/0027
222/182
- 2014/0166776 A1 * 6/2014 Fang B05B 17/0638
239/102.2

* cited by examiner

Primary Examiner — Rhea Shields
(74) *Attorney, Agent, or Firm* — Novick, Kim & Lee,
PLLC; Sang Ho Lee; Hyun Woo Shin

- (30) **Foreign Application Priority Data**
Feb. 22, 2018 (KR) 30-2018-0008889
- (51) **LOC (12) Cl.** **09-01**
- (52) **U.S. Cl.**
USPC **D9/687**
- (58) **Field of Classification Search**
USPC D9/687, 686, 560, 529, 573, 448;
D28/76, 91.1, 58; D23/366; D27/141
CPC B65D 83/56; B05B 15/30; B05B 11/0027;
B05B 17/0638
See application file for complete search history.

(57) **CLAIM**

The ornamental design for an atomizer for perfumes, as shown and described.

DESCRIPTION

- 1. Atomizer for perfumes
- 1.1 : Perspective
- 1.2 : Front
- 1.3 : Back
- 1.4 : Left
- 1.5 : Right
- 1.6 : Top
- 1.7 : Bottom

1 Claim, 7 Drawing Sheets

- (56) **References Cited**
U.S. PATENT DOCUMENTS
D190,785 S * 6/1961 Kruck D9/687
D306,554 S * 3/1990 Lawson D9/573
D513,186 S * 12/2005 Dehaene D9/529

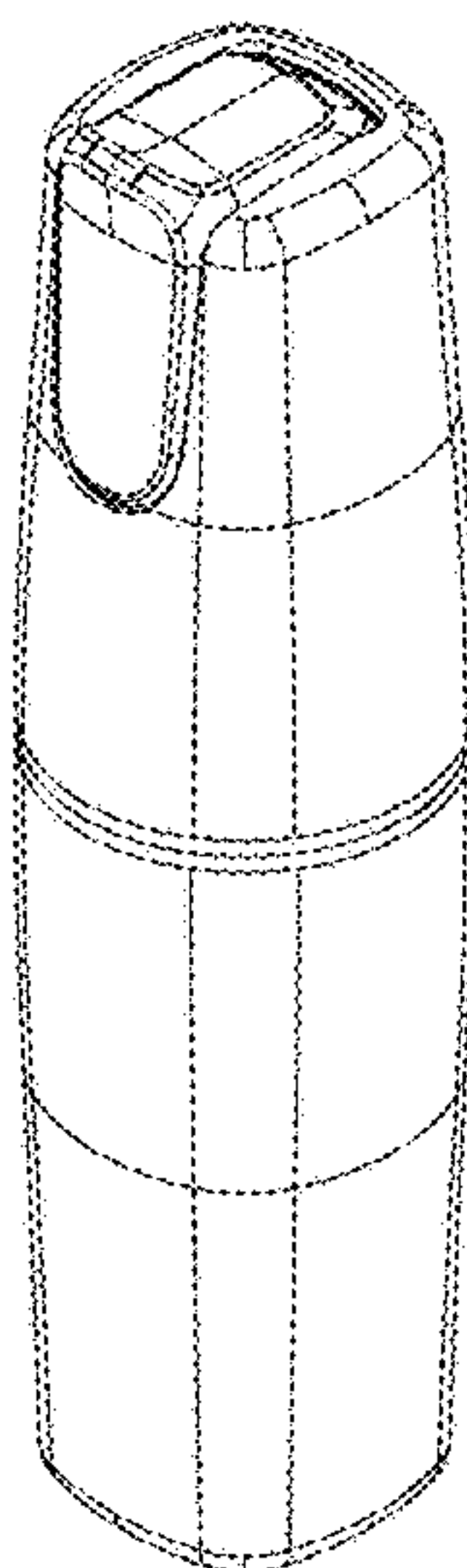

1.1

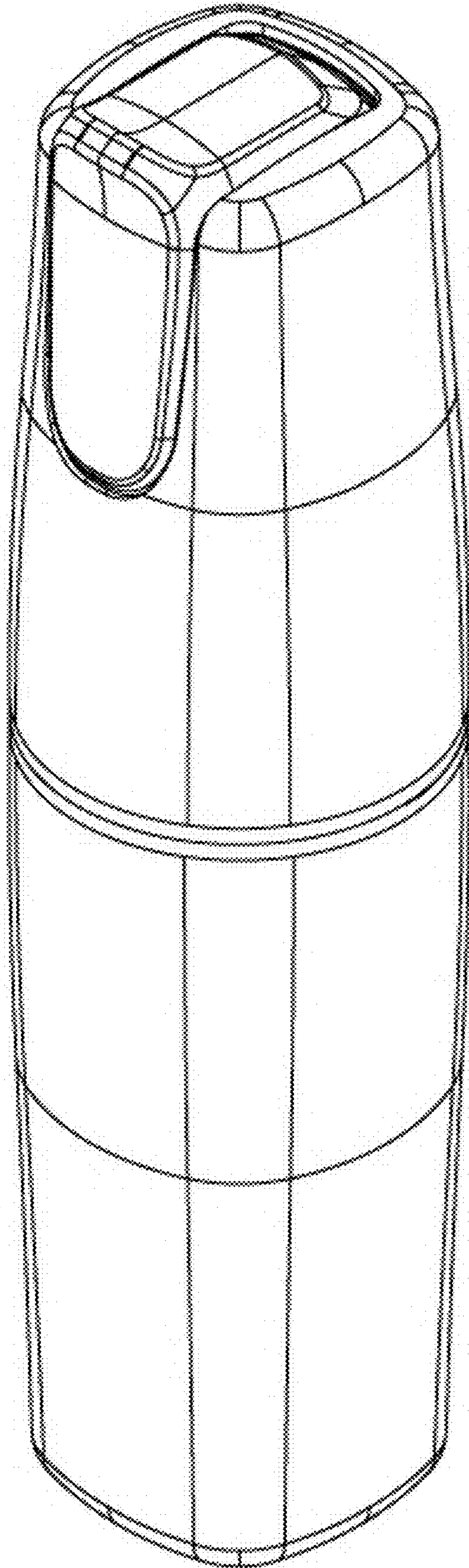

1.2

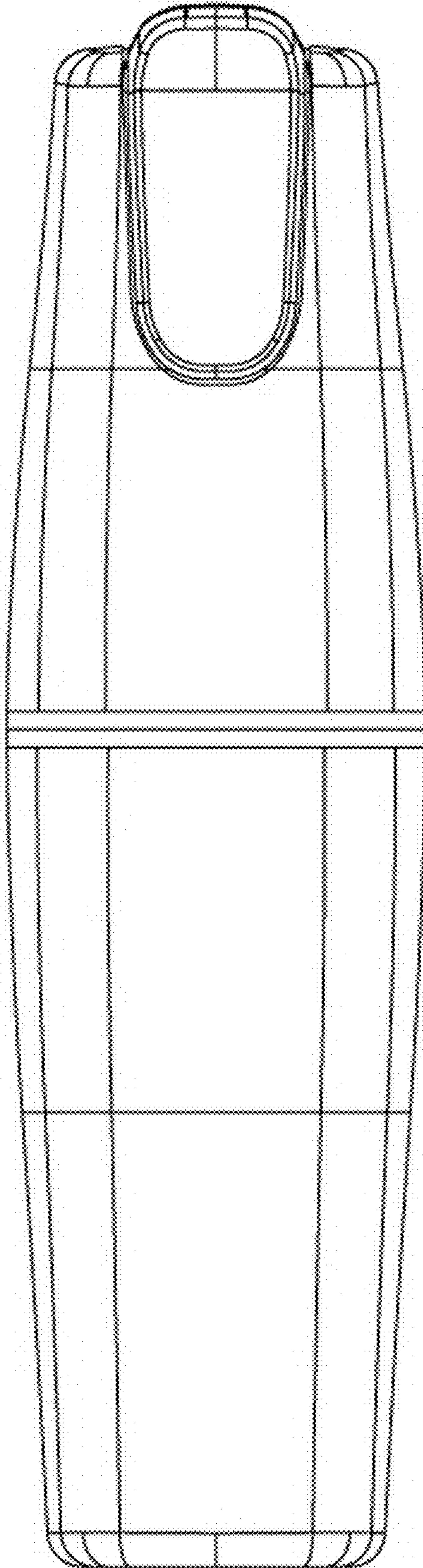

1.3

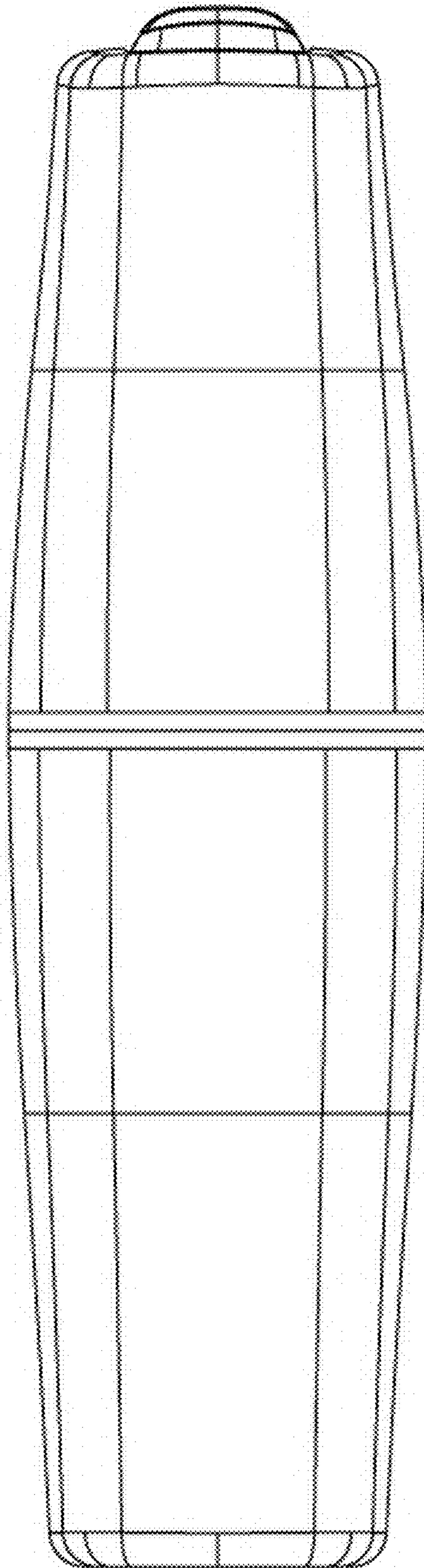

1.4

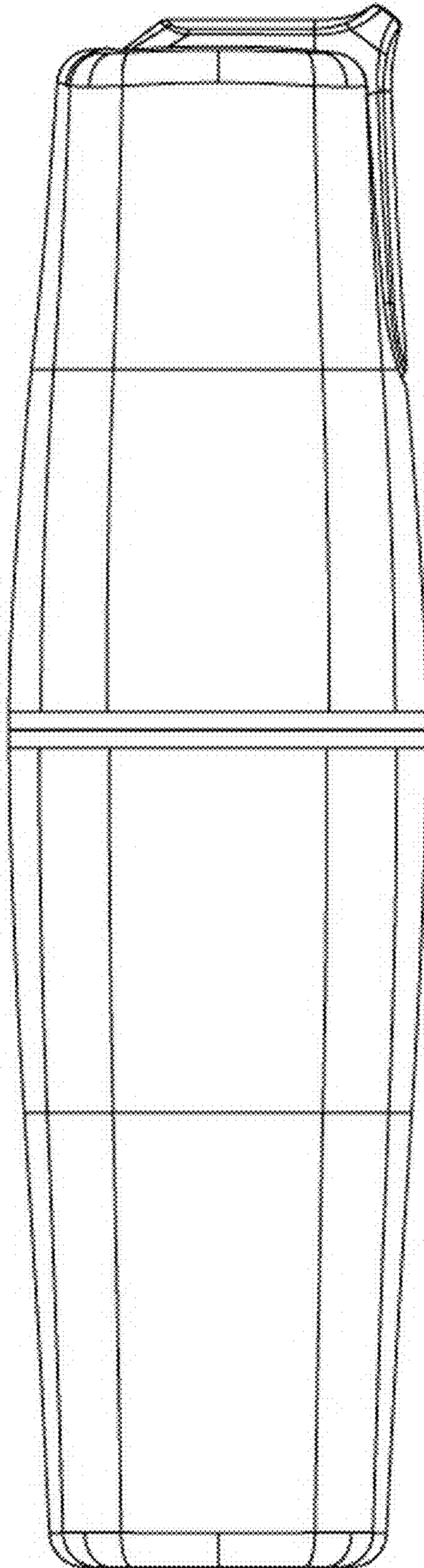

1.5

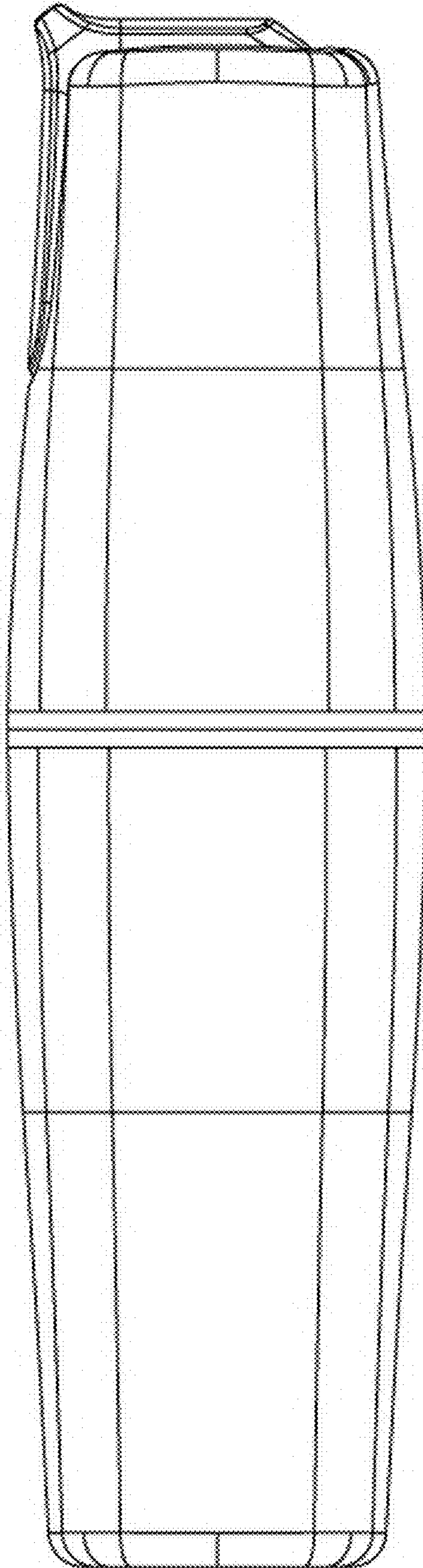

1.6

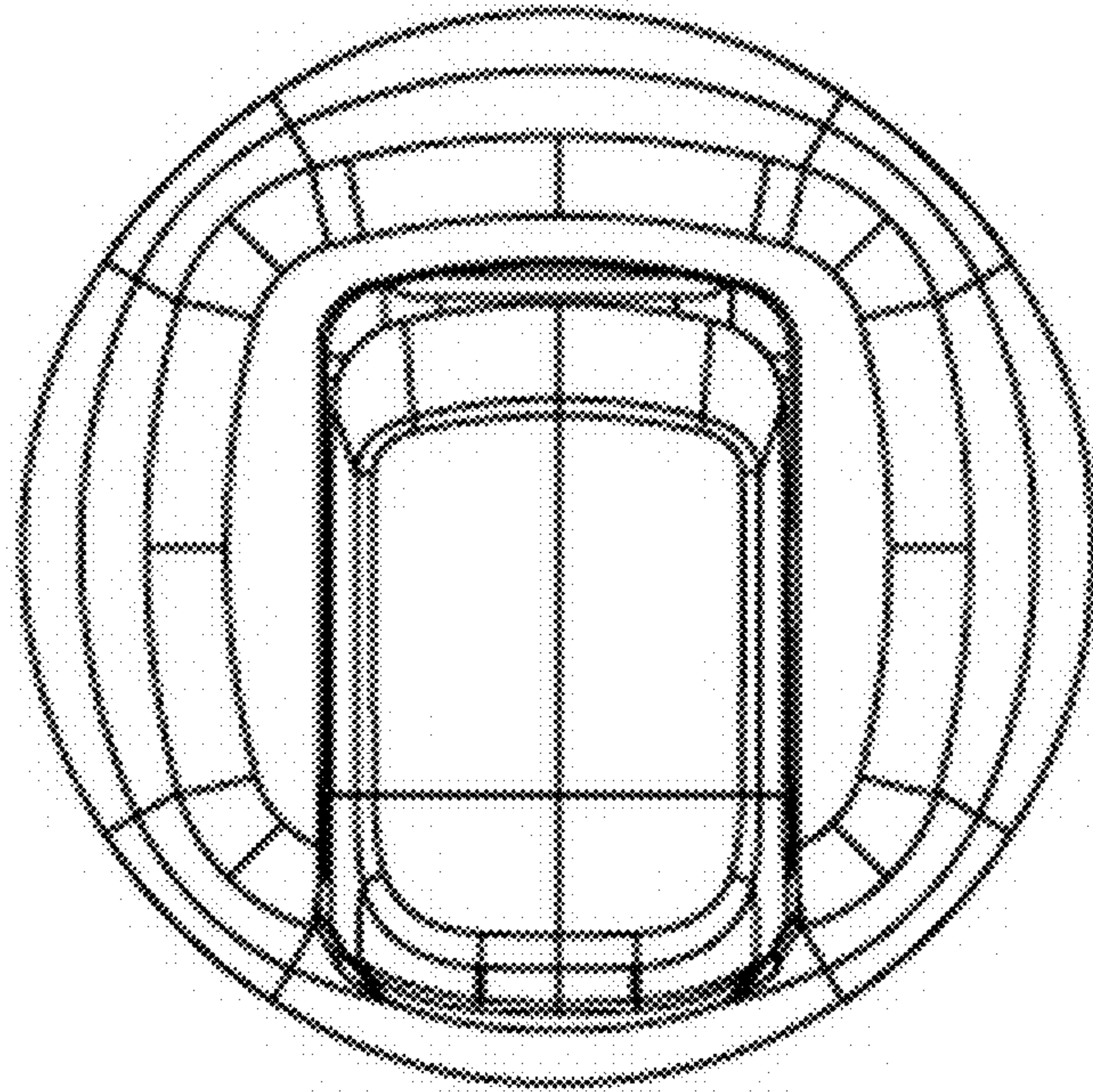

1.7

