



US00D873664S

(12) **United States Design Patent**  
**Manansingh**

(10) **Patent No.:** **US D873,664 S**

(45) **Date of Patent:** **\*\* Jan. 28, 2020**

(54) **SMART USB CARD TRAY**

(71) Applicant: **TVM.Bio Inc.**, Tampa, FL (US)

(72) Inventor: **Raj Manansingh**, Tampa, FL (US)

(\*\*) Term: **15 Years**

(21) Appl. No.: **29/673,687**

(22) Filed: **Dec. 17, 2018**

(51) **LOC (12) Cl.** ..... **09-07**

(52) **U.S. Cl.**  
USPC ..... **D9/456**

(58) **Field of Classification Search**  
USPC ..... D9/423, 456, 737; D6/407, 632;  
D3/627, 631, 634; D14/385, 387, 434,  
D14/483  
CPC ..... G11B 23/0316; G11B 33/0427; G11B  
33/0422; G11B 17/03; Y10T 24/44017;  
Y10T 70/5004; B65D 85/57  
See application file for complete search history.

(56) **References Cited**

**U.S. PATENT DOCUMENTS**

D347,999 S *	6/1994	Pritchard	.....	D6/632
D351,829 S *	10/1994	Maines	.....	D14/483
D376,289 S *	12/1996	Swanick	.....	D6/407
D385,145 S *	10/1997	VerWeyst	.....	206/308.1
6,443,306 B1 *	9/2002	Davies	.....	B65D 5/5038
				206/307
D474,935 S *	5/2003	Goto	.....	D6/407
D492,876 S *	7/2004	Goto	.....	D6/407
D572,588 S *	7/2008	Osborn	.....	D9/456
D633,388 S *	3/2011	Andre	.....	D9/456

D663,206 S *	7/2012	Nelson	.....	D9/456
D665,215 S *	8/2012	Zealer	.....	D6/632
D756,223 S *	5/2016	Pipes	.....	D9/456
2018/0341936 A1 *	11/2018	Manansingh	.....	G06F 13/4081

**OTHER PUBLICATIONS**

Brandedmedia USB Business card packaging, published Mar. 7, 2011 [online], [retrieved on Nov. 21, 2019]. Retrieved from Internet, <URL: <http://www.brandedmedia.net/blog/2011/03/07/usb-business-card-packaging-usb-business-card-box/>>.\*  
MIP Plastic Group USB Card Tray, [online], [retrieved on Nov. 21, 2019]. Retrieved from Internet, <URL: [https://mip-packaging.net/en/?mip\\_product=usb-card-tray](https://mip-packaging.net/en/?mip_product=usb-card-tray)>.\*

\* cited by examiner

*Primary Examiner* — Bridget L Eland  
(74) *Attorney, Agent, or Firm* — Not Just Patents LLC;  
Wendy S Peterson

(57) **CLAIM**

The ornamental design for a smart USB card tray, as shown.

**DESCRIPTION**

FIG. 1 is a front perspective view of a smart USB card tray showing my new design;  
FIG. 2 is a front view thereof;  
FIG. 3 is a back view thereof;  
FIG. 4 is a bottom view thereof;  
FIG. 5 is a top view thereof;  
FIG. 6 is a left view thereof; and,  
FIG. 7 is a right view thereof.

**1 Claim, 5 Drawing Sheets**

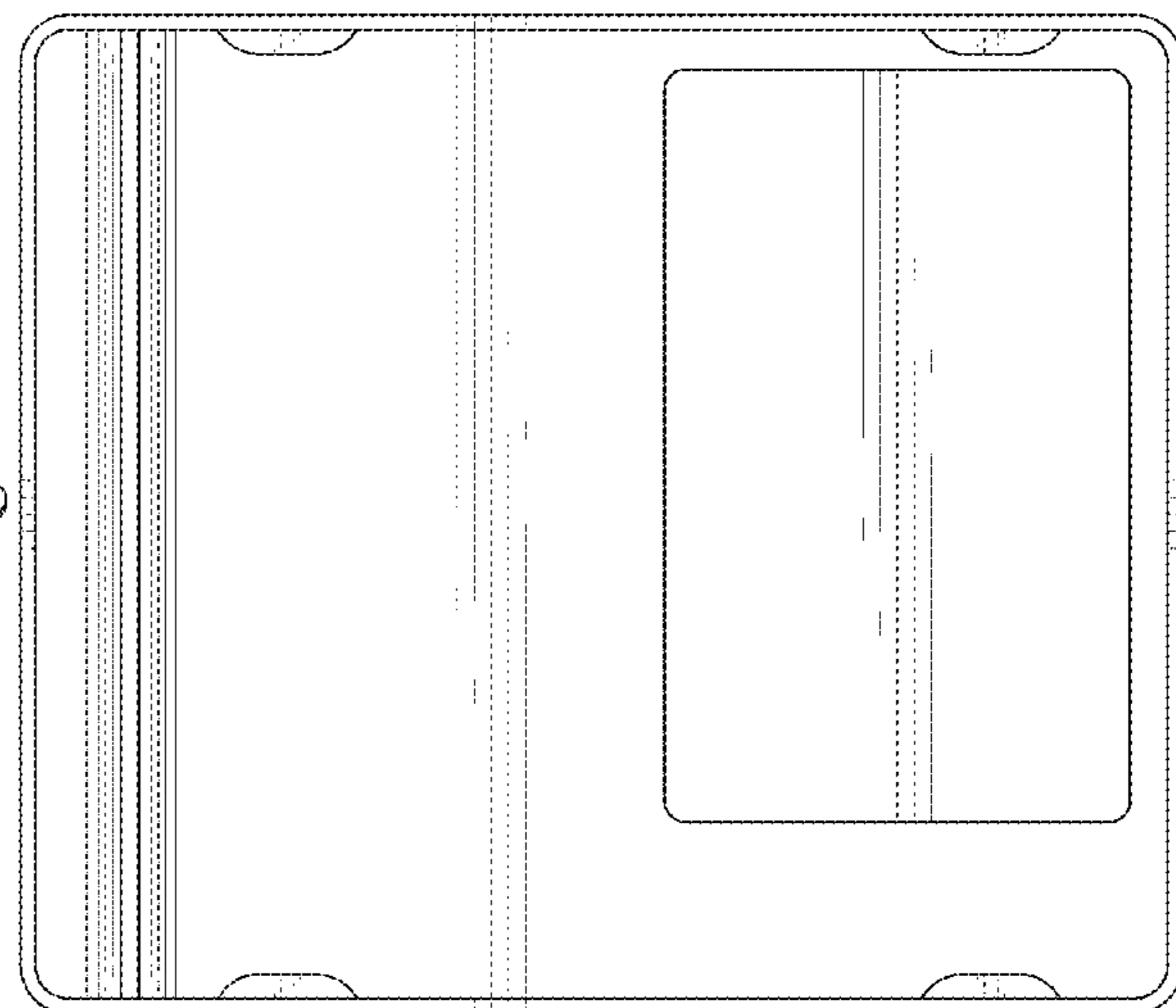
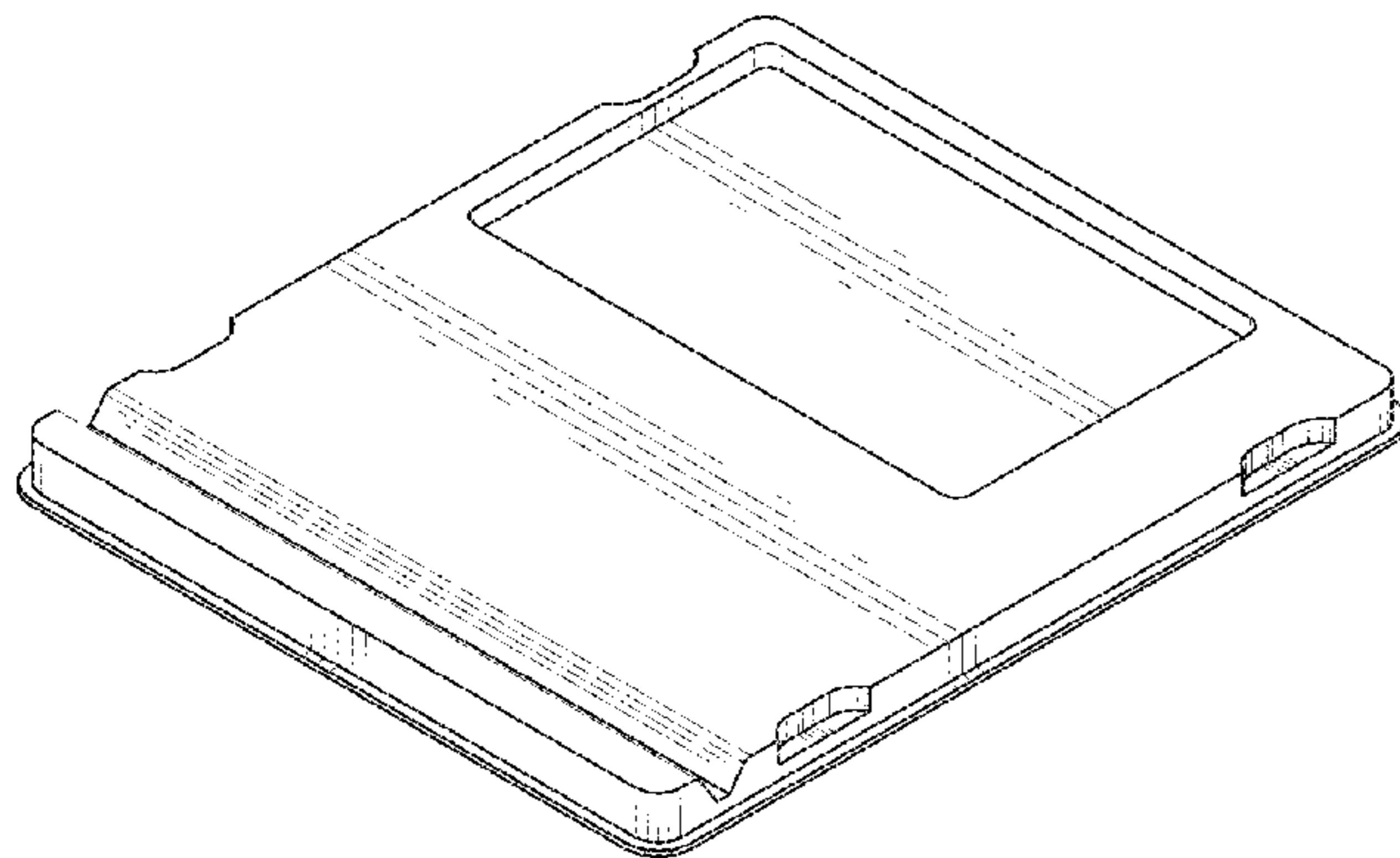

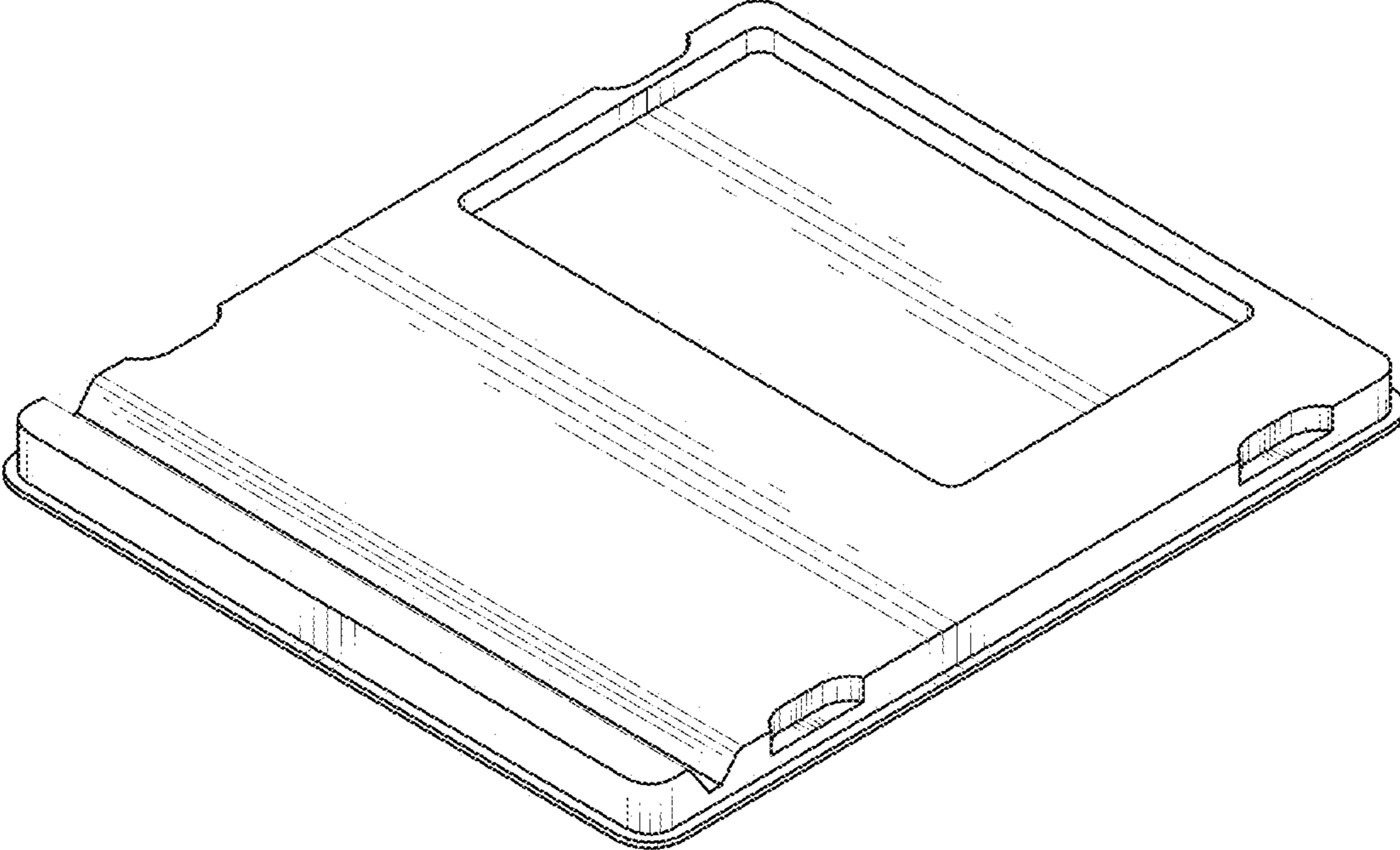

FIG. 1

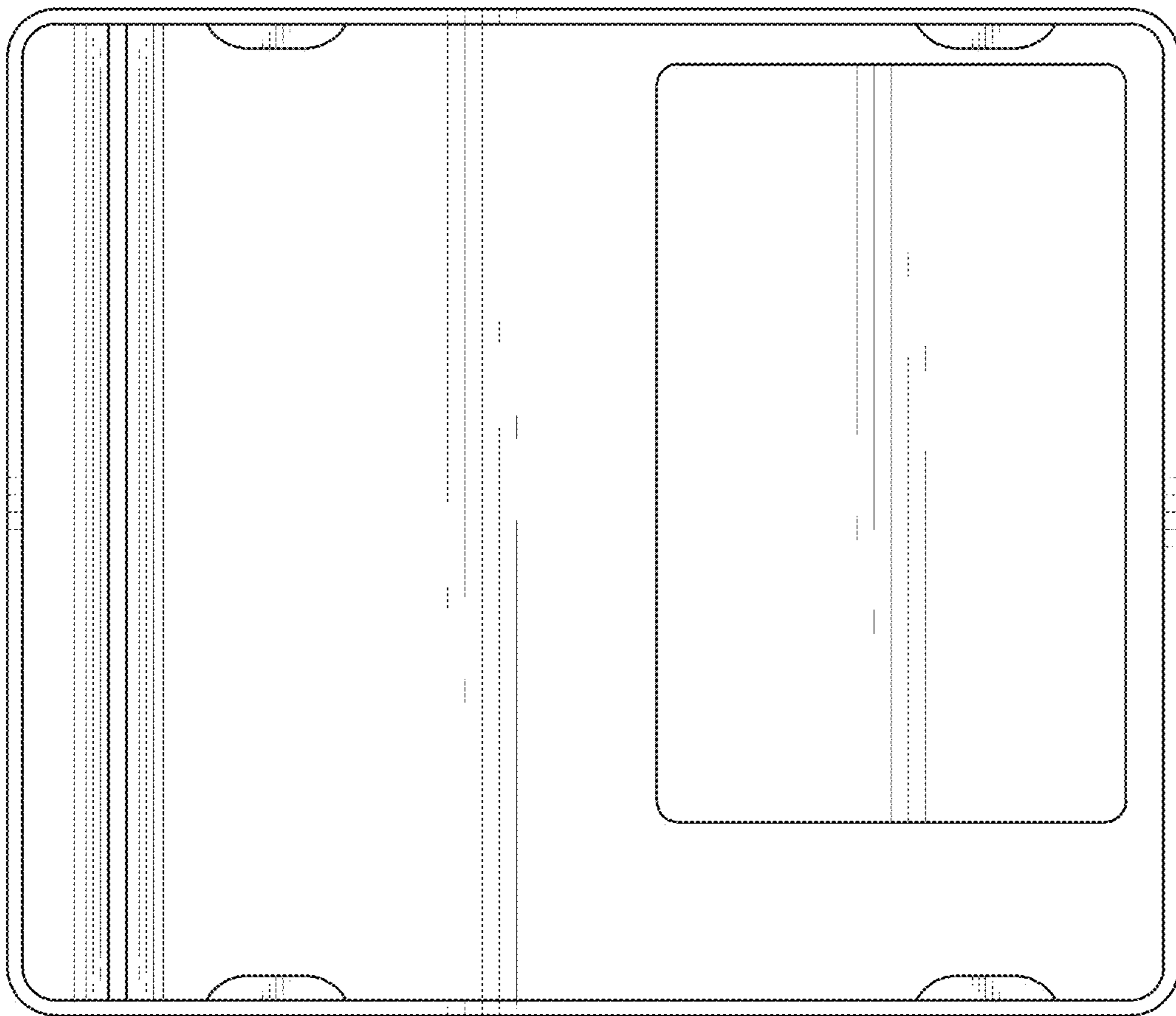

FIG. 2

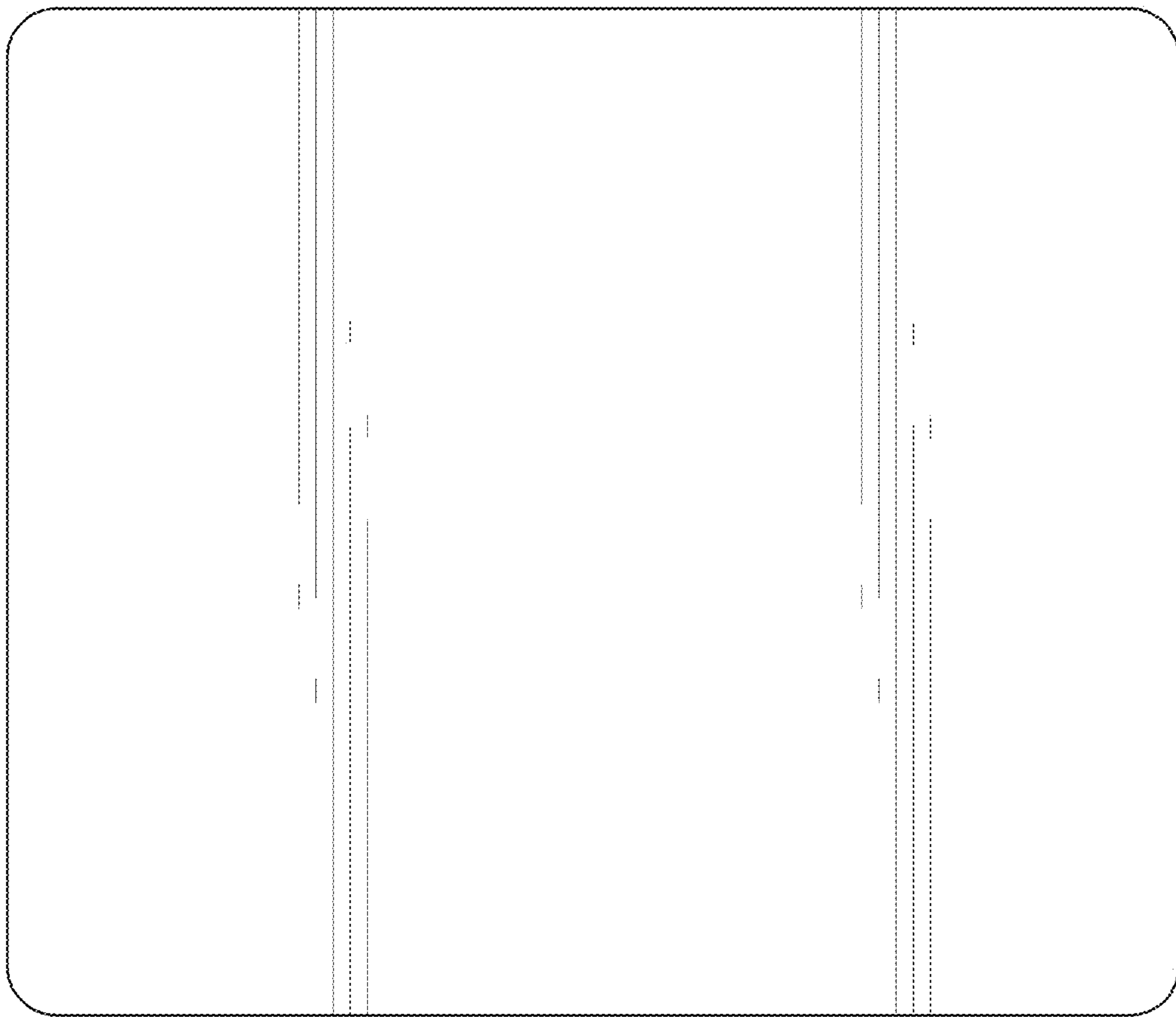

FIG. 3

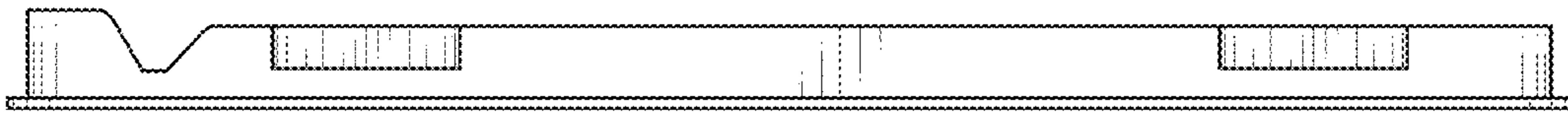

FIG. 4

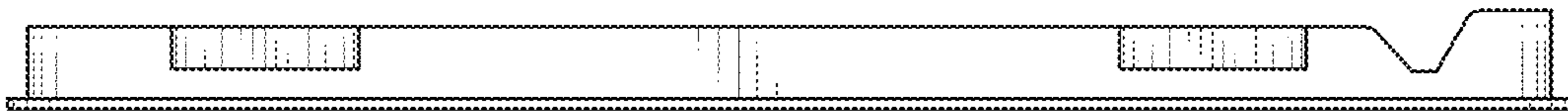

FIG. 5

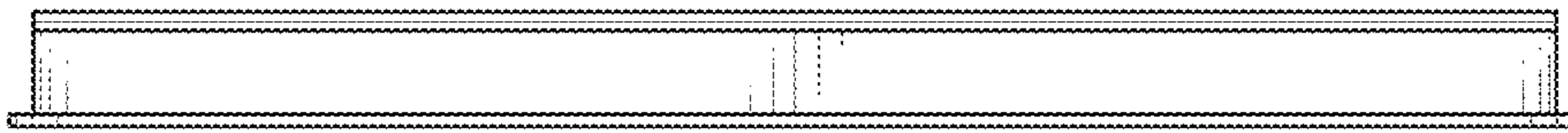

FIG. 6

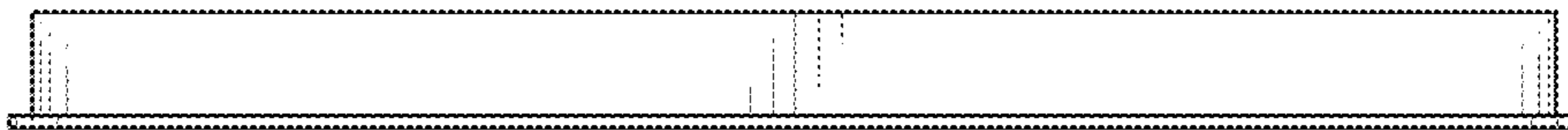

FIG. 7