



US00D873631S

(12) **United States Design Patent** (10) **Patent No.:** **US D873,631 S**
Hsu (45) **Date of Patent:** **** Jan. 28, 2020**

(54) **GARDEN SCISSORS**
(71) Applicant: **Flying-High International Industrial Co., Ltd., Taipei (TW)**
(72) Inventor: **Chi-Rung Hsu, Taipei (TW)**
(73) Assignee: **Flying-High International Industrial Supply Co., Ltd., Taipei (TW)**
(**) Term: **15 Years**
(21) Appl. No.: **29/629,022**
(22) Filed: **Dec. 11, 2017**
(51) **LOC (12) Cl.** **08-01**
(52) **U.S. Cl.**
USPC **D8/5**
(58) **Field of Classification Search**
USPC D8/4-5, 52, 54, 57
See application file for complete search history.

D638,674 S * 5/2011 Huang D8/5
D640,106 S * 6/2011 Molina D8/5
D642,032 S * 7/2011 Molina D8/5
2003/0159292 A1 * 8/2003 Wu A01G 3/02
30/123.3
2012/0047745 A1 * 3/2012 Wu A01G 3/02
30/146
2014/0041236 A1 * 2/2014 Podlesny A01G 3/021
30/266

* cited by examiner

Primary Examiner — Sheryl Lane
(74) *Attorney, Agent, or Firm* — Adam D. Kamrath;
Karin L. Williams; Mayer & Williams PC

(57) **CLAIM**

The ornamental design for garden scissors, as shown and described.

DESCRIPTION

FIG. 1 is a perspective view of garden scissors showing my new design;
FIG. 2 is a front elevational view thereof;
FIG. 3 is a rear elevational view thereof;
FIG. 4 is a left side elevational view thereof;
FIG. 5 is a right side elevational view thereof;
FIG. 6 is a top plan view thereof; and,
FIG. 7 is a bottom plan view thereof.
The broken lines represent portions of the garden scissors, and form no part of the claimed design.

1 Claim, 6 Drawing Sheets

(56) **References Cited**
U.S. PATENT DOCUMENTS
D380,358 S * 7/1997 Wu D8/5
D470,732 S * 2/2003 Wu D8/5
6,675,481 B2 * 1/2004 Wu A01G 3/02
30/123.3
D545,646 S * 7/2007 Shan D8/5
D547,139 S * 7/2007 Shan D8/5
D580,236 S * 11/2008 Wu D8/5
D630,067 S * 1/2011 Block D8/5

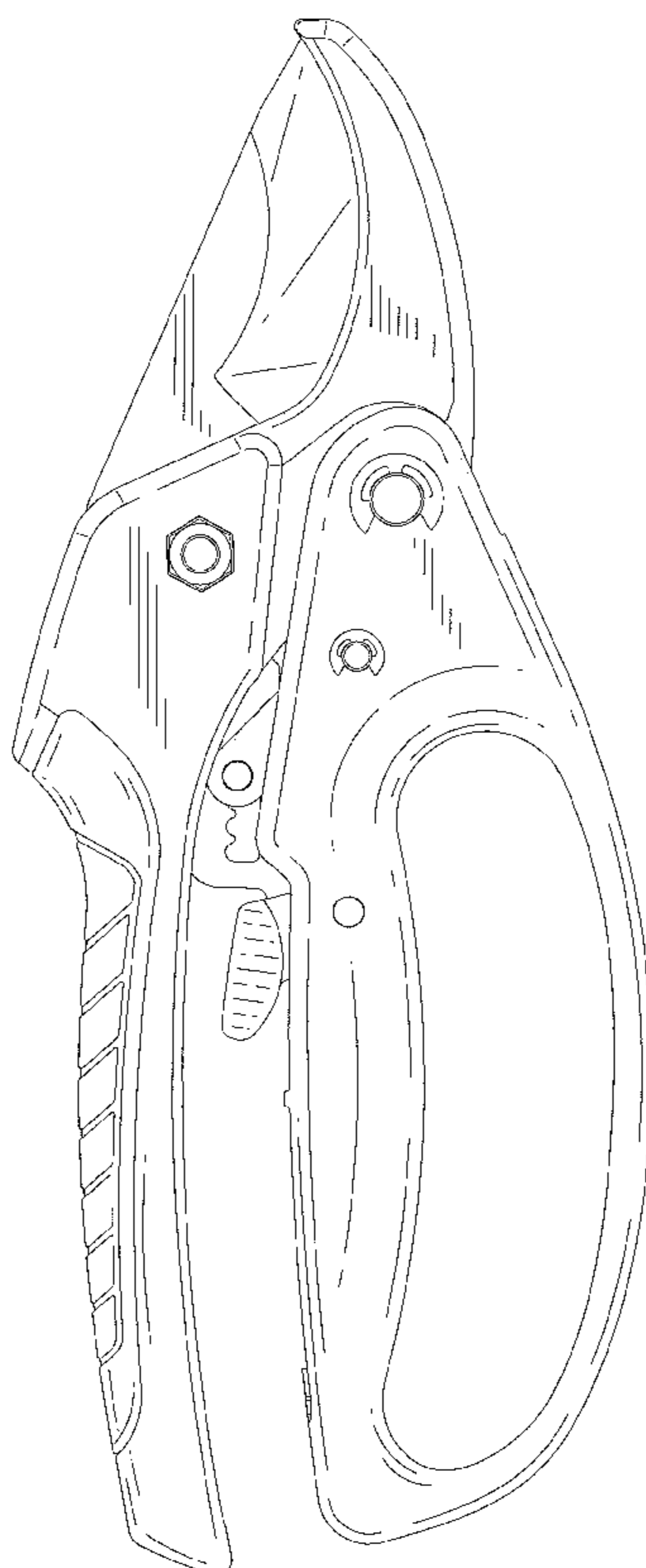

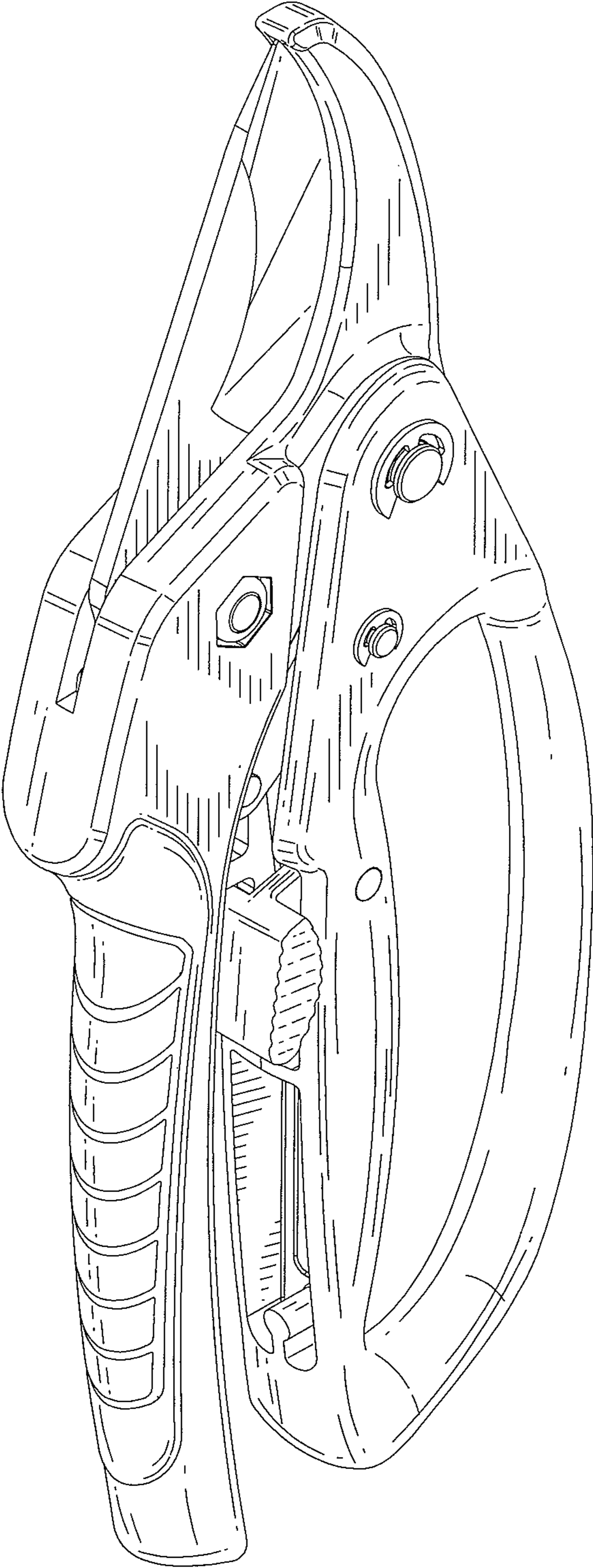

FIG. 1

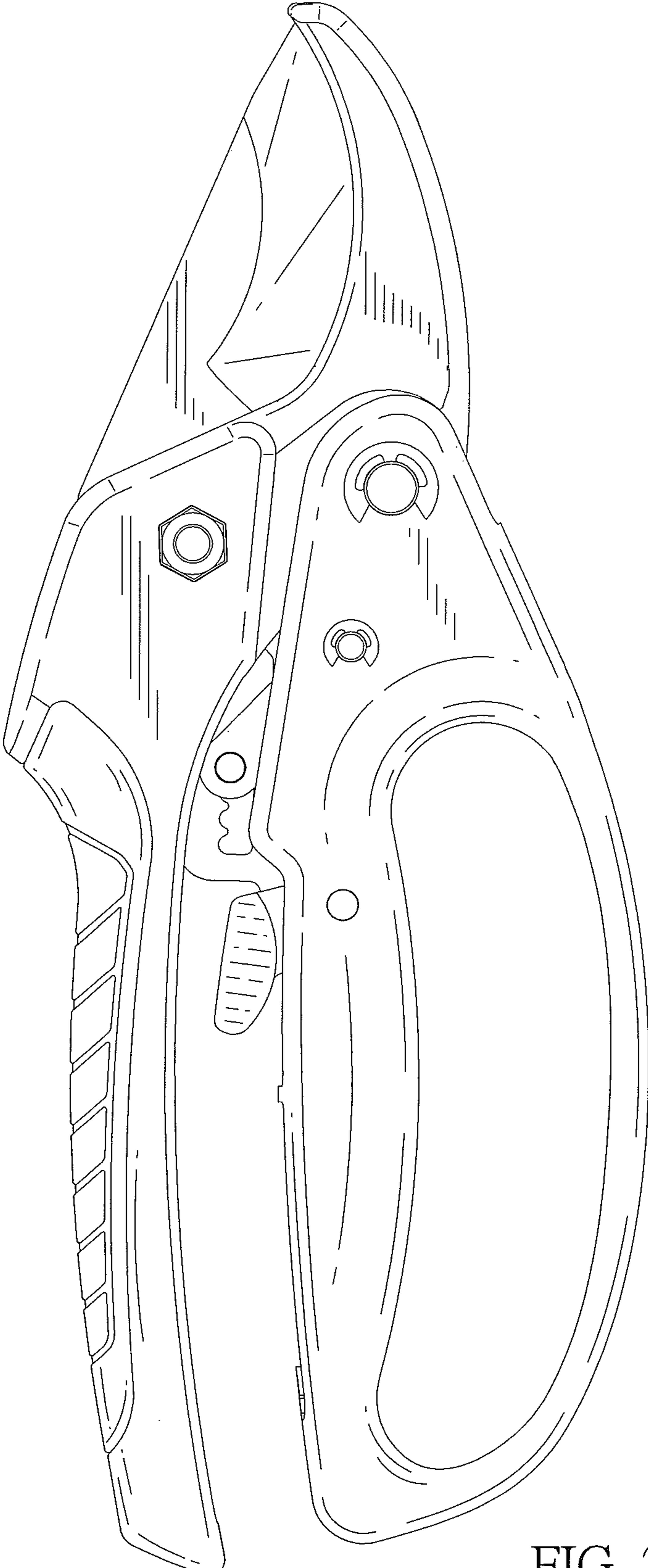

FIG. 2

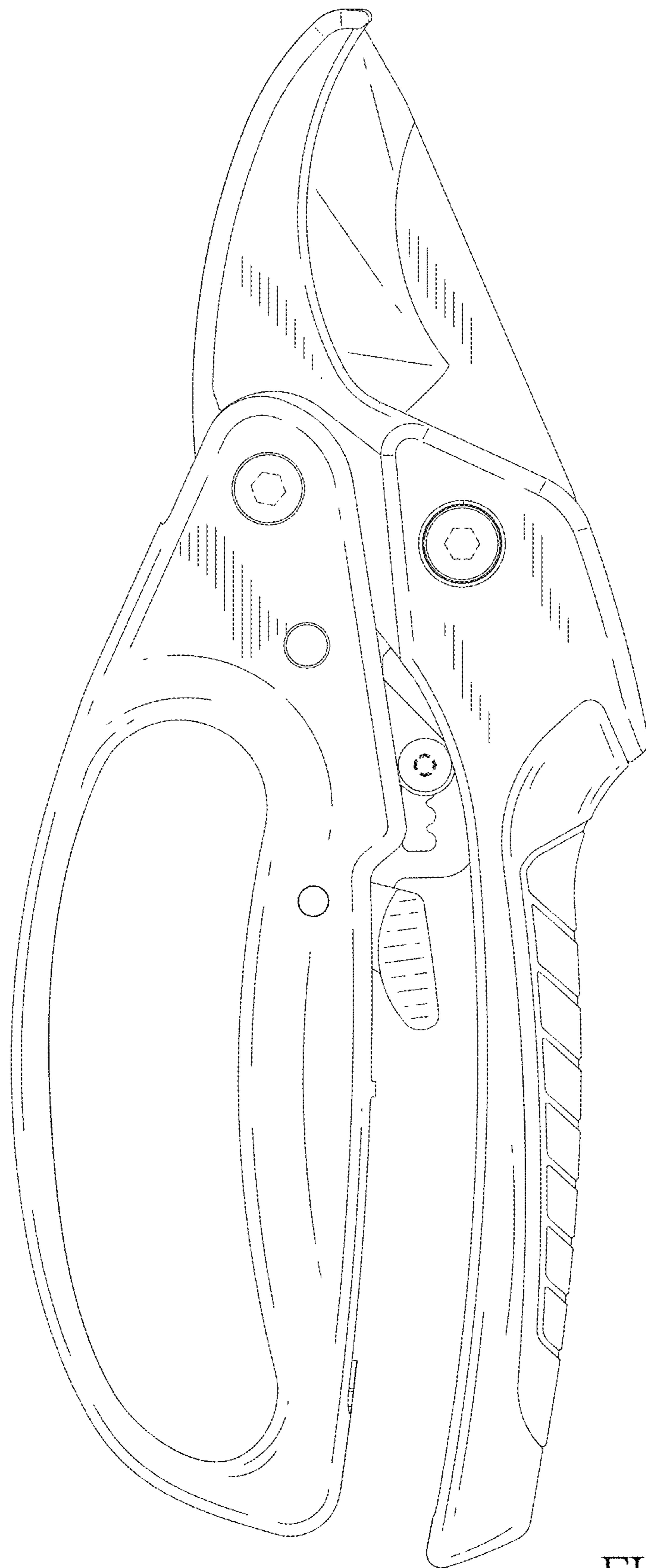

FIG. 3

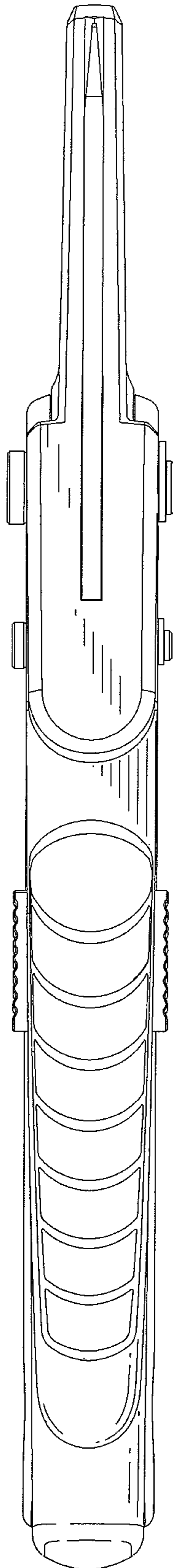

FIG. 4

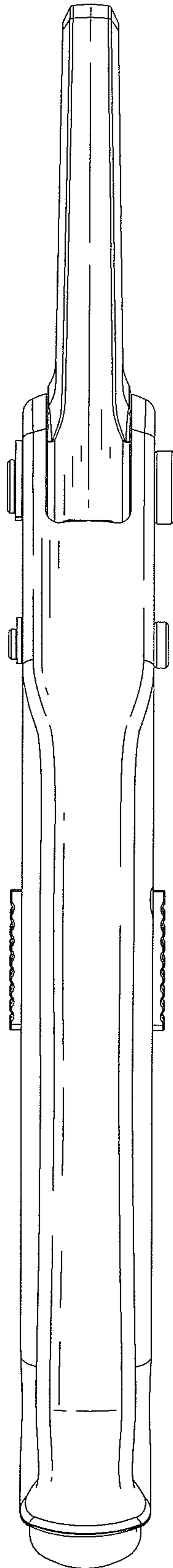

FIG. 5

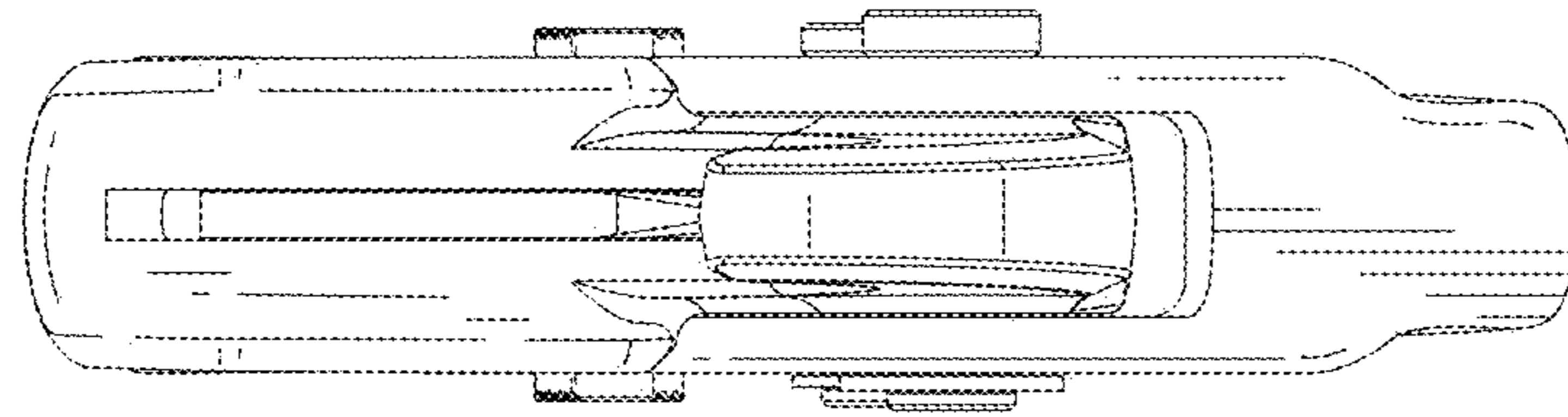

FIG. 6

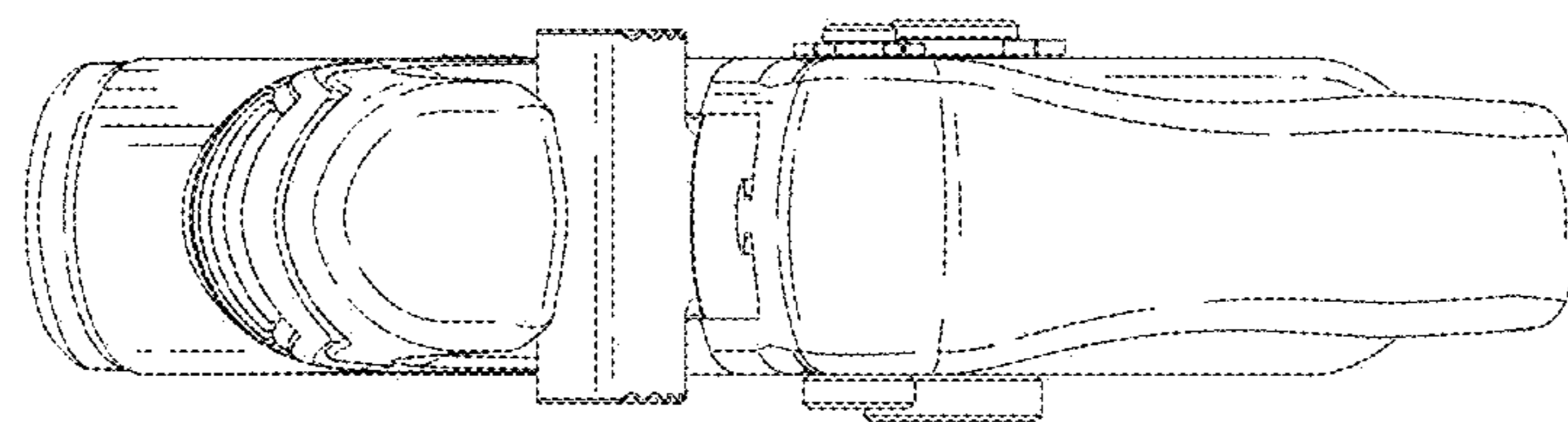

FIG. 7