



US00D873593S

(12) **United States Design Patent**
Jiang

(10) **Patent No.:** **US D873,593 S**

(45) **Date of Patent:** **** Jan. 28, 2020**

(54) **PEDESTAL**

(71) Applicant: **HUI ZHOU J AND C**
INTELLIGENT FURNISHINGS
TECHNOLOGY CO., LTD., Huizhou
(CN)

(72) Inventor: **Rongshan Jiang**, Huizhou (CN)

(73) Assignee: **HUI ZHOU J AND C**
INTELLIGENT FURNISHINGS
TECH. CO., LTD., Huizhou (CN)

(**) Term: **15 Years**

(21) Appl. No.: **29/633,105**

(22) Filed: **Jan. 12, 2018**

(51) **LOC (12) Cl.** **06-06**

(52) **U.S. Cl.**
USPC **D6/708.17**

(58) **Field of Classification Search**
USPC D6/349, 352, 691.4, 702, 708, 708.17,
D6/709

CPC . A47B 13/00; A47B 13/023; A47B 2013/025;
A47B 91/00; A47B 91/005; A47B 97/00;
A47B 2200/002; A47B 2200/0022

See application file for complete search history.

(56) **References Cited**

U.S. PATENT DOCUMENTS

D241,699 S * 10/1976 Barecki D6/708.17
D313,910 S * 1/1991 Kubryk D6/691.4

D471,888 S * 3/2003 Solland D14/204
D532,618 S * 11/2006 Mourgue D6/352
D763,619 S * 8/2016 Girardi D7/306
D764,198 S * 8/2016 Yoshida D6/352
D802,973 S * 11/2017 Chang D6/708.17

* cited by examiner

Primary Examiner — Mary Ann Calabrese

(74) *Attorney, Agent, or Firm* — Hemisphere Law, PLLC;
Zhigang Ma

(57) **CLAIM**

The ornamental design for a pedestal, as shown and described.

DESCRIPTION

FIG. 1 is a perspective view of a supporting assembly showing my new design;
FIG. 2 is a front elevational view thereof, the back elevation is identical thereto, and thus omitted;
FIG. 3 is a side elevational view thereof, the opposite elevation is identical thereto, and thus omitted;
FIG. 4 is a top plan view thereof;
FIG. 5 is a bottom plan view thereof; and,
FIG. 6 is a perspective view of the supporting assembly installed with a table and a substrate in use.
The broken lines immediately adjacent to claim as shown in the drawings represent the boundaries of the claimed design and form no part thereof. All other broken lines are directed to environment and form no part of the claimed design.

1 Claim, 6 Drawing Sheets

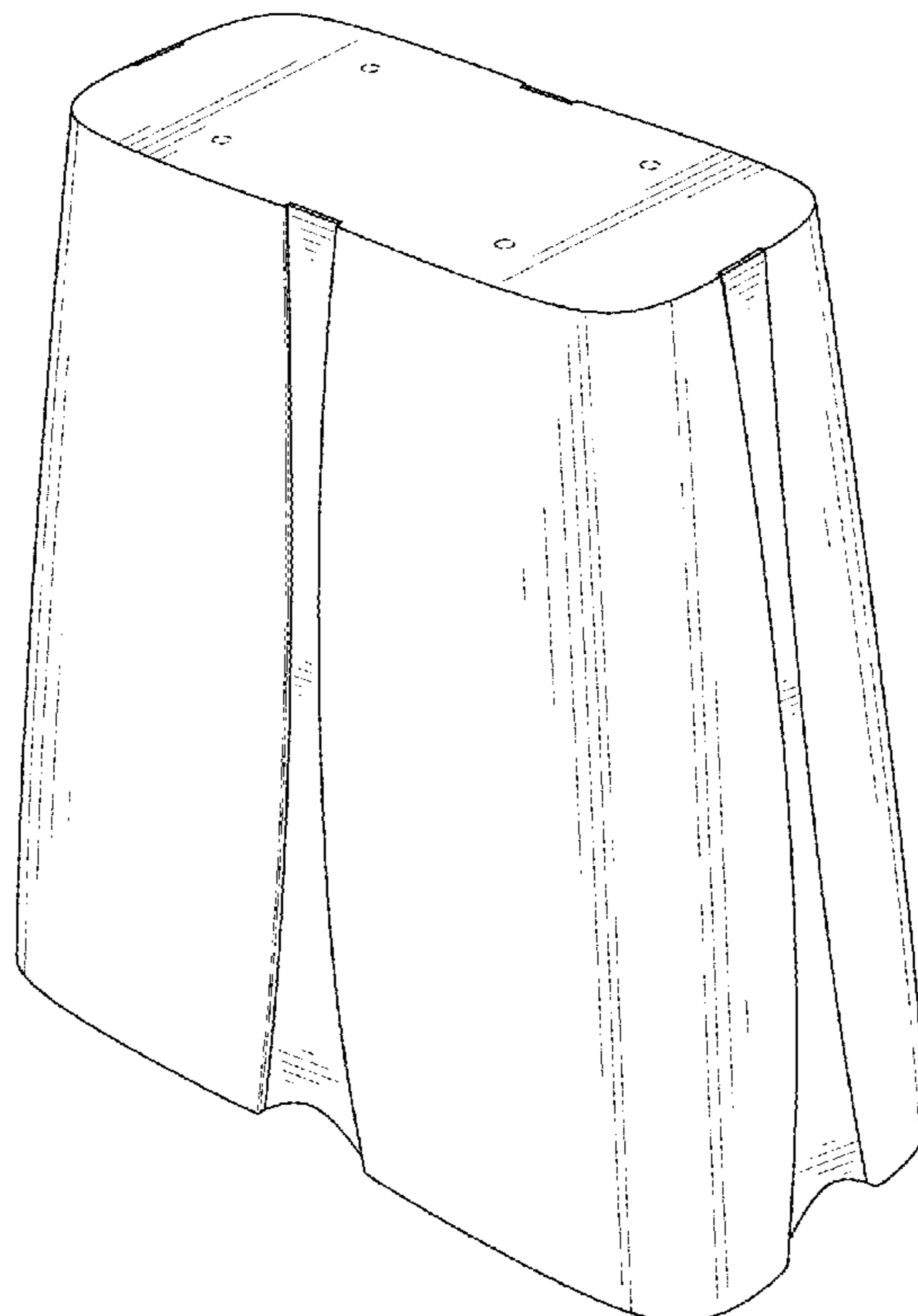

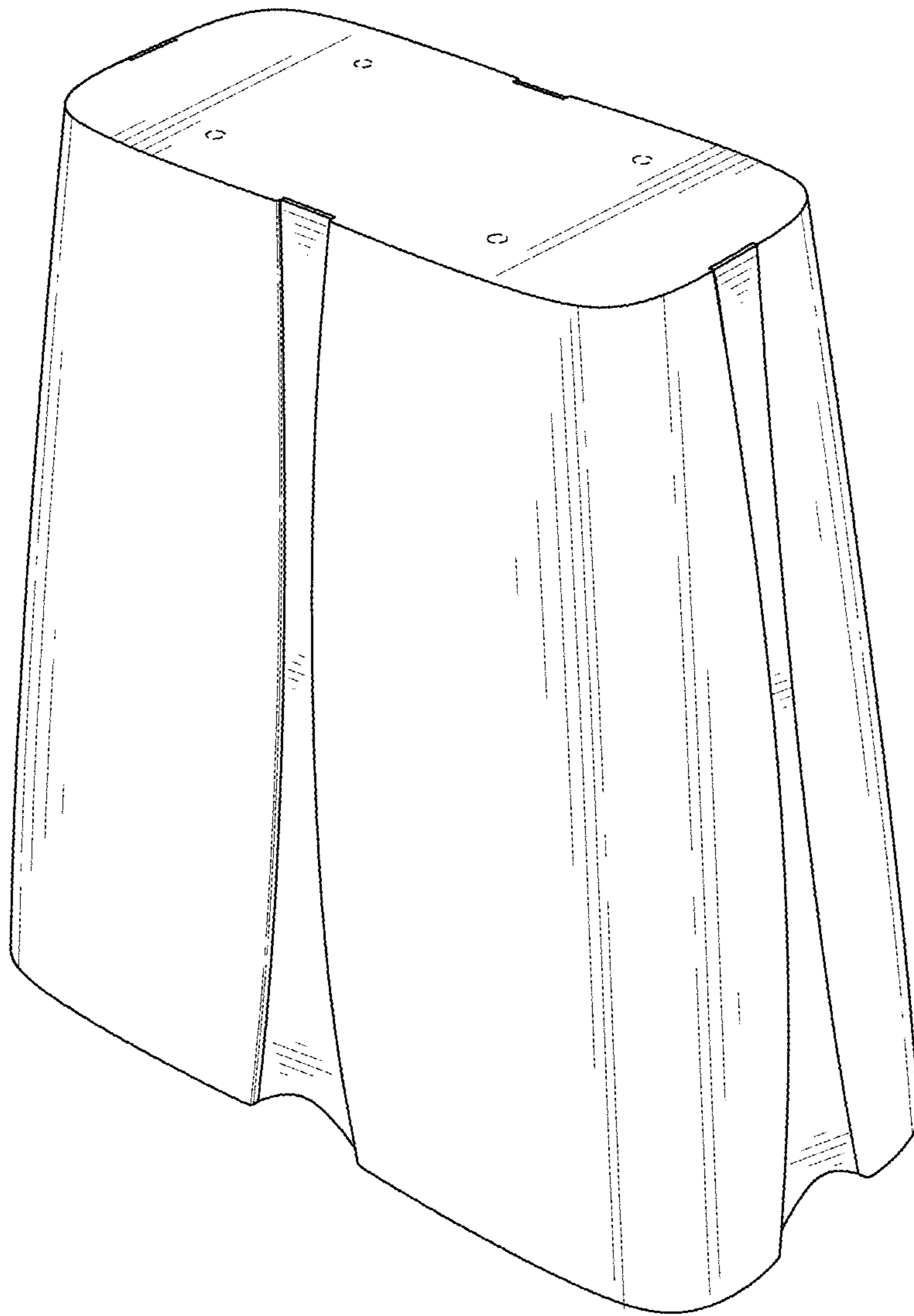

FIG. 1

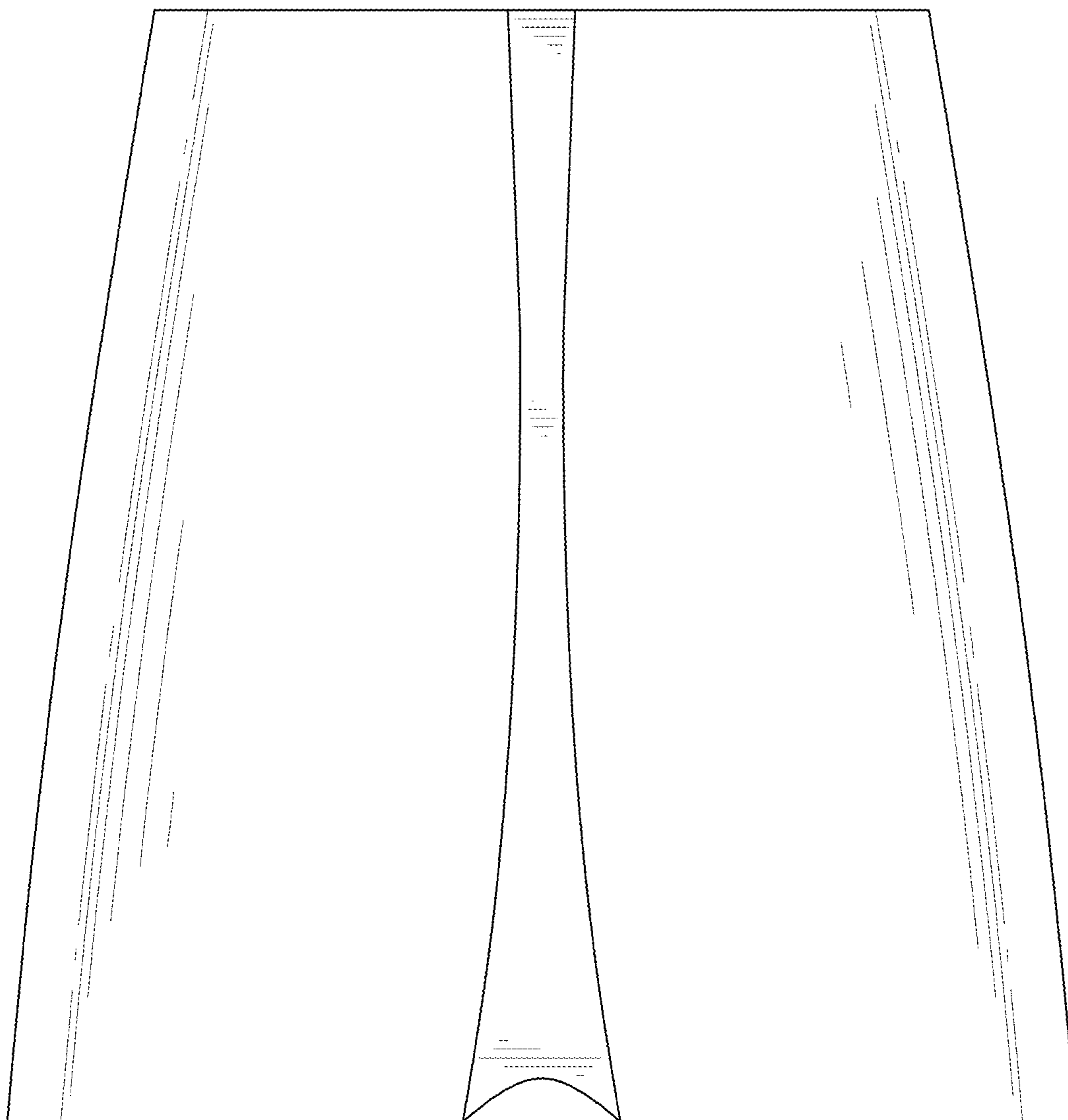

FIG. 2

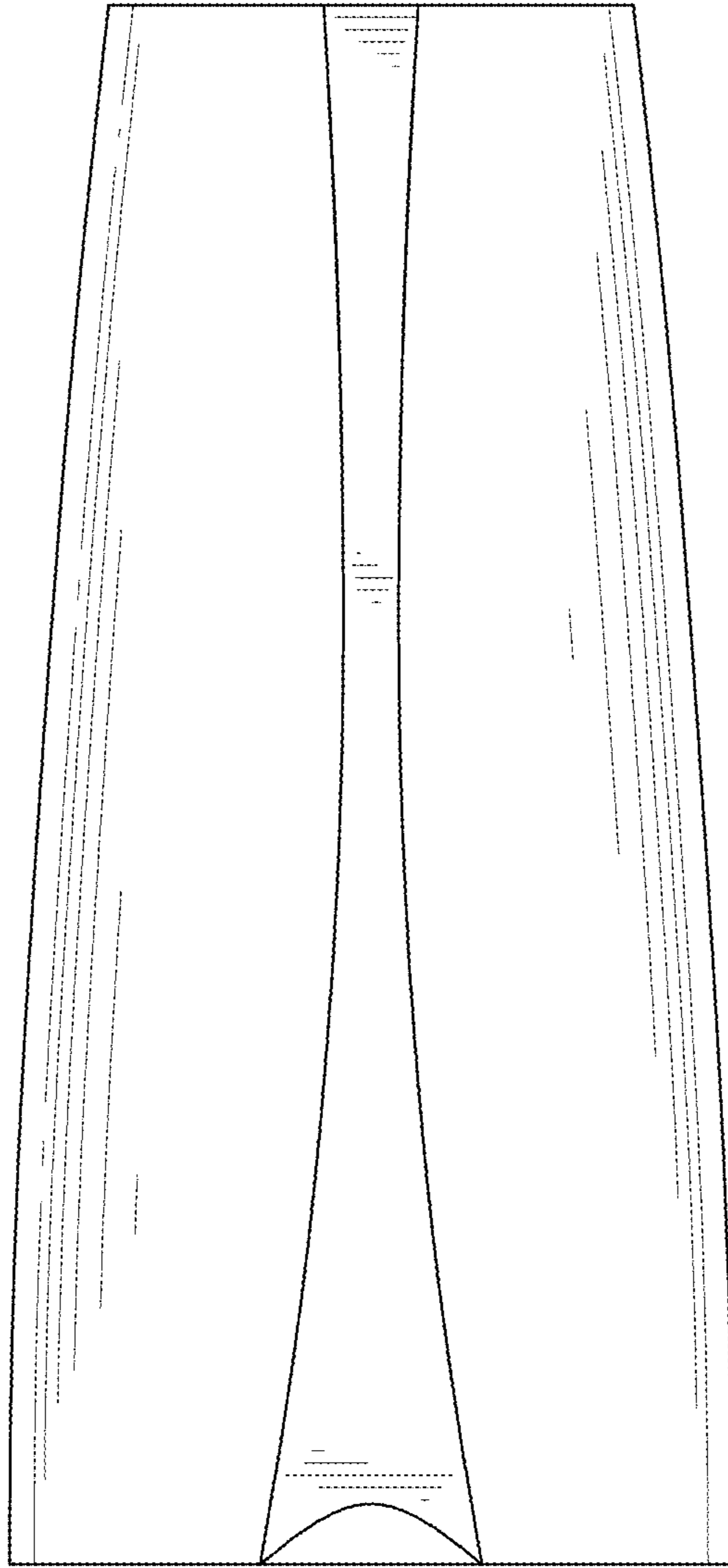

FIG. 3

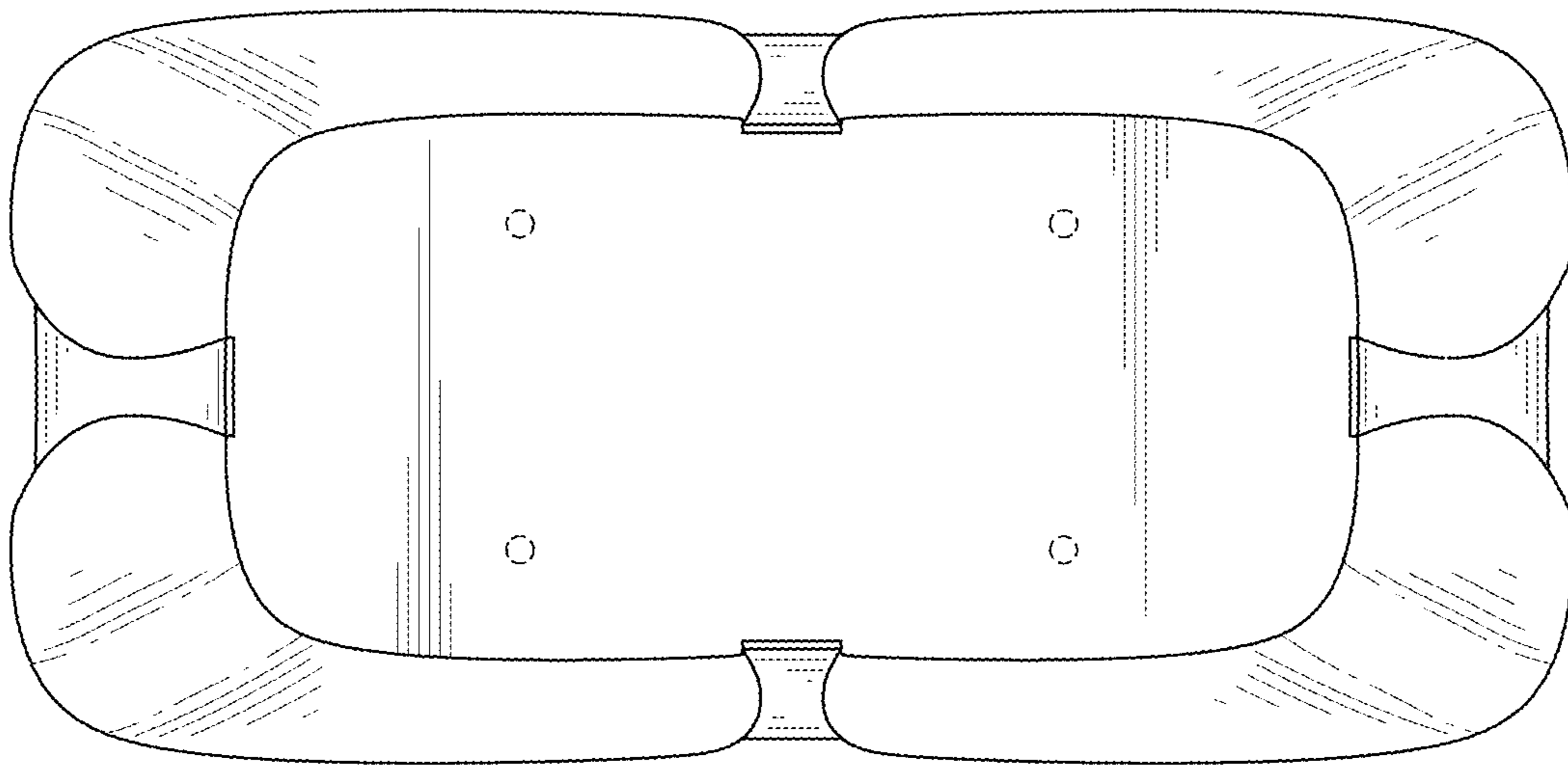

FIG. 4

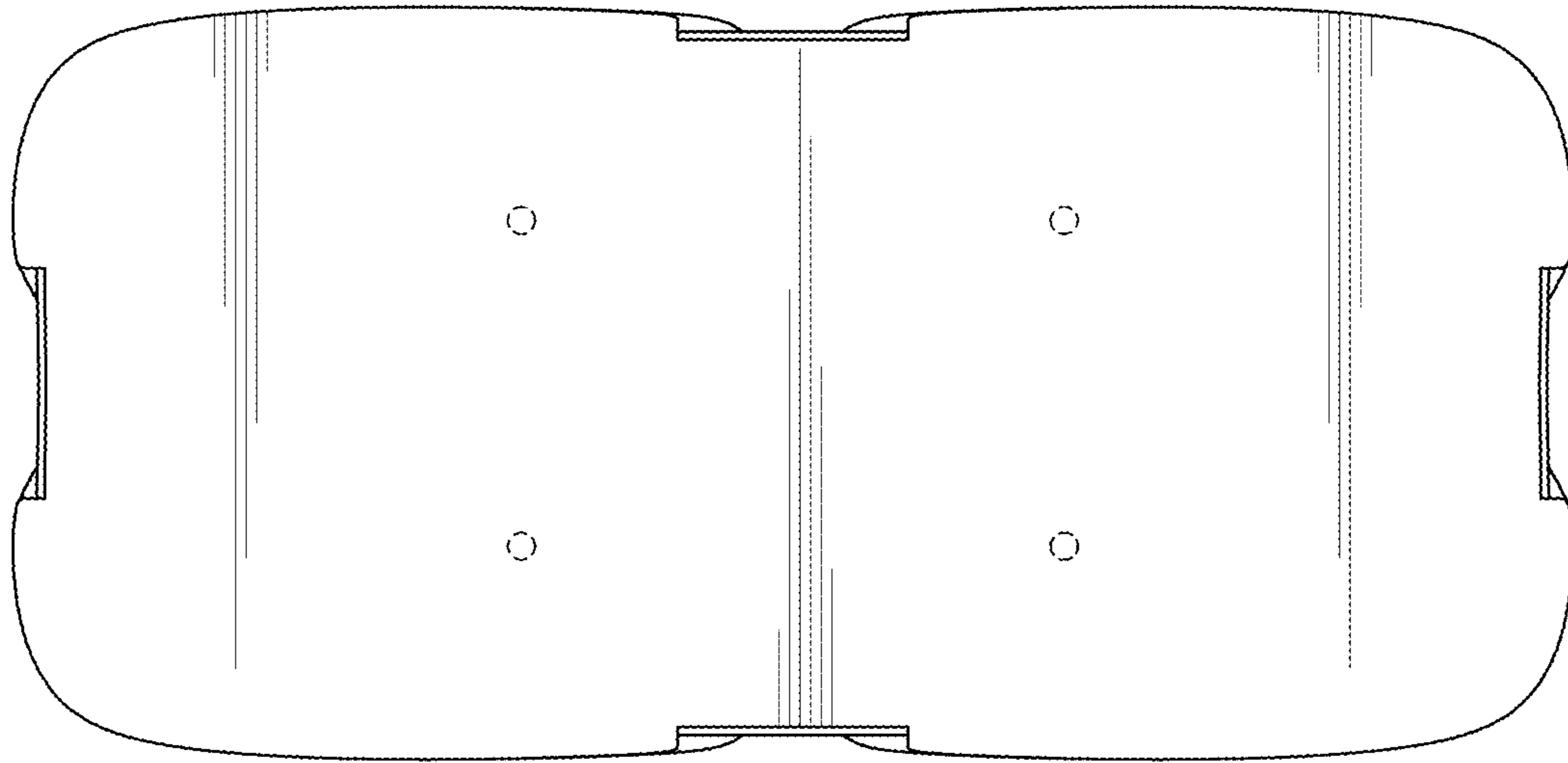

FIG. 5

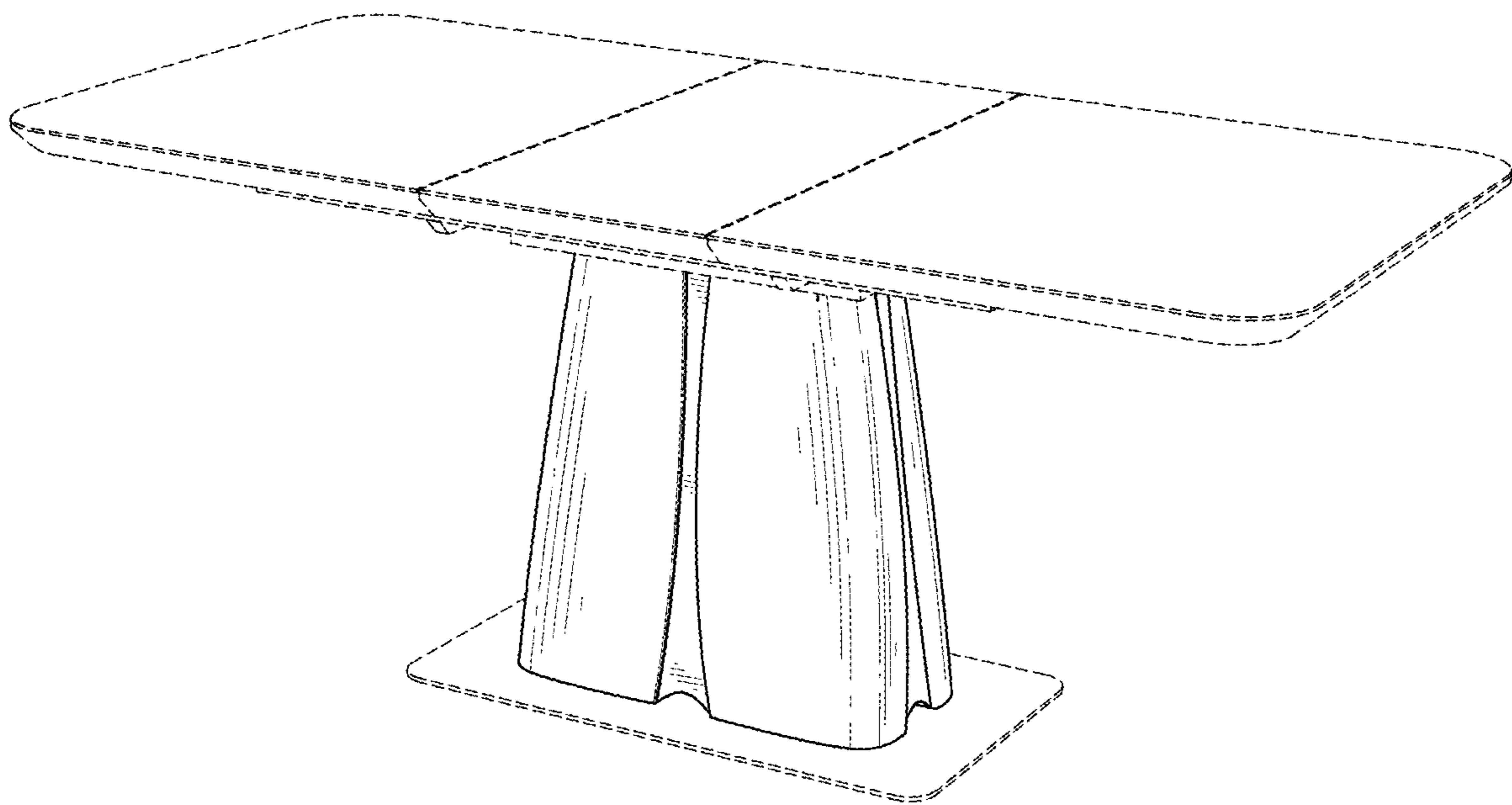

FIG. 6