



US00D873557S

(12) **United States Design Patent**
Pompliano

(10) **Patent No.:** **US D873,557 S**
(45) **Date of Patent:** **** Jan. 28, 2020**

(54) **COMBINATION GAME BACKPACK AND
DETACHABLE COOLER**

D421,837 S * 3/2000 Pradella D3/205
D429,448 S * 8/2000 Nottingham D3/276
D558,406 S * 12/2007 King D30/109
D580,164 S * 11/2008 Boretti D3/238

(71) Applicant: **Brandon Pompliano**, Highlands, NJ
(US)

(Continued)

(72) Inventor: **Brandon Pompliano**, Highlands, NJ
(US)

OTHER PUBLICATIONS

(73) Assignee: **Koolbol**, Highlands, NJ (US)

Kickstarter, "All in One Games, Cooler & Backpack for Beach-
BBQ-Tailgate by Koolbol", Project launched Jul. 15, 2015. (<https://www.kickstarter.com/projects/koolbol/all-in-one-sports-tailgating-goal-cooler-and-backpack>) (Year: 2015).*

(**) Term: **15 Years**

Primary Examiner — April Rivas

(21) Appl. No.: **29/604,204**

(57) **CLAIM**

(22) Filed: **May 16, 2017**

The ornamental design for a combination game backpack and detachable cooler, as shown and described.

Related U.S. Application Data

DESCRIPTION

(63) Continuation-in-part of application No. 14/975,096,
filed on Dec. 18, 2015, now Pat. No. 9,839,281.

(51) **LOC (12) Cl.** **03-01**

(52) **U.S. Cl.**
USPC **D3/217; D3/257; D3/274; D7/607**

(58) **Field of Classification Search**
USPC D3/205, 216, 217, 243, 254, 273, 276,
D3/277, 283, 287, 289, 290, 304, 306,
D3/309, 900, 902, 904, 246, 257, 274;
D7/605, 607, 608
CPC A45C 3/001; A45C 2003/002; A45C
2003/008; A45C 5/005; A45C 11/20;
A45F 4/02

See application file for complete search history.

FIG. 1 is a front elevational view of a combination game backpack and detachable cooler;
FIG. 2 is a right side elevational view thereof;
FIG. 3 is a rear elevational view thereof;
FIG. 4 is a left side elevational view thereof;
FIG. 5 is a top plan view thereof;
FIG. 6 is a bottom plan view thereof;
FIG. 7 is a front perspective view thereof;
FIG. 8 is a rear perspective view thereof;
FIG. 9 is a front elevational view of a combination game backpack and detachable cooler, showing the cooler detached with the top open and the game backpack with an open front pocket;
FIG. 10 is a right side elevational view thereof;
FIG. 11 is a rear elevational view thereof;
FIG. 12 is a left side elevational view thereof;
FIG. 13 is a top plan view thereof;
FIG. 14 is a bottom plan view thereof;
FIG. 15 is a front perspective view thereof; and,
FIG. 16 is a rear perspective view thereof.

(56) **References Cited**

U.S. PATENT DOCUMENTS

D277,901 S * 3/1985 Leslie D3/217
D307,811 S * 5/1990 Branco D3/289
D356,888 S * 4/1995 Myers D3/254
5,975,293 A * 11/1999 Fowler A63B 71/0045
206/315.9
D419,770 S * 2/2000 Mogil D3/276

1 Claim, 16 Drawing Sheets

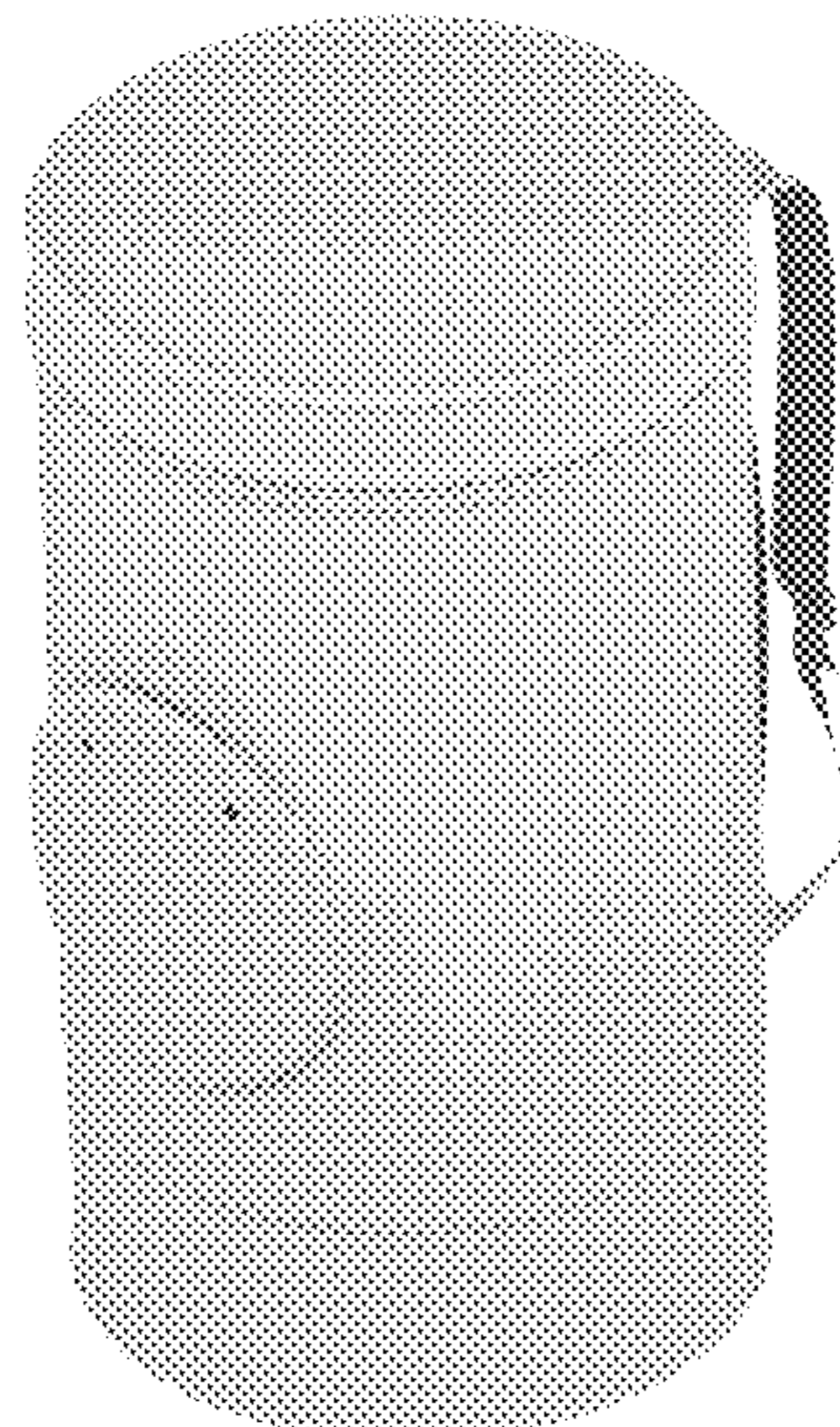

(56)

References Cited

U.S. PATENT DOCUMENTS

D590,148 S *	4/2009	Lin	D3/217
D601,796 S *	10/2009	Banks	D3/279
D749,838 S *	2/2016	Romley	D3/217
D768,981 S *	10/2016	Kliot	D3/217
D772,561 S *	11/2016	Polunsky	D3/216
D773,809 S *	12/2016	Lieser	D3/232
D786,555 S *	5/2017	Brungraber	D3/284
D793,717 S *	8/2017	Boljat	D3/205
D820,649 S *	6/2018	Sisson	D7/607

* cited by examiner

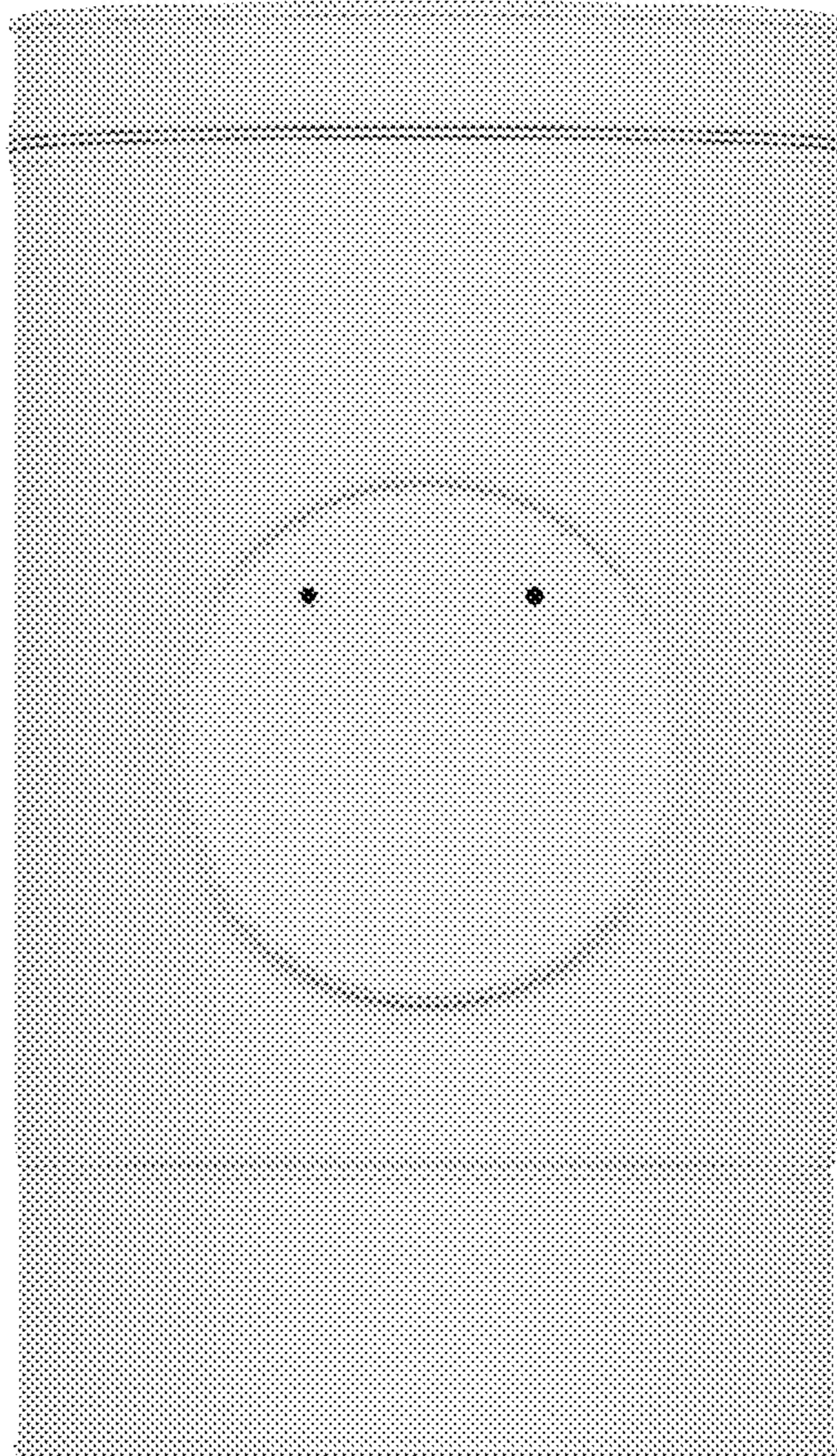

FIG. 1



FIG. 2

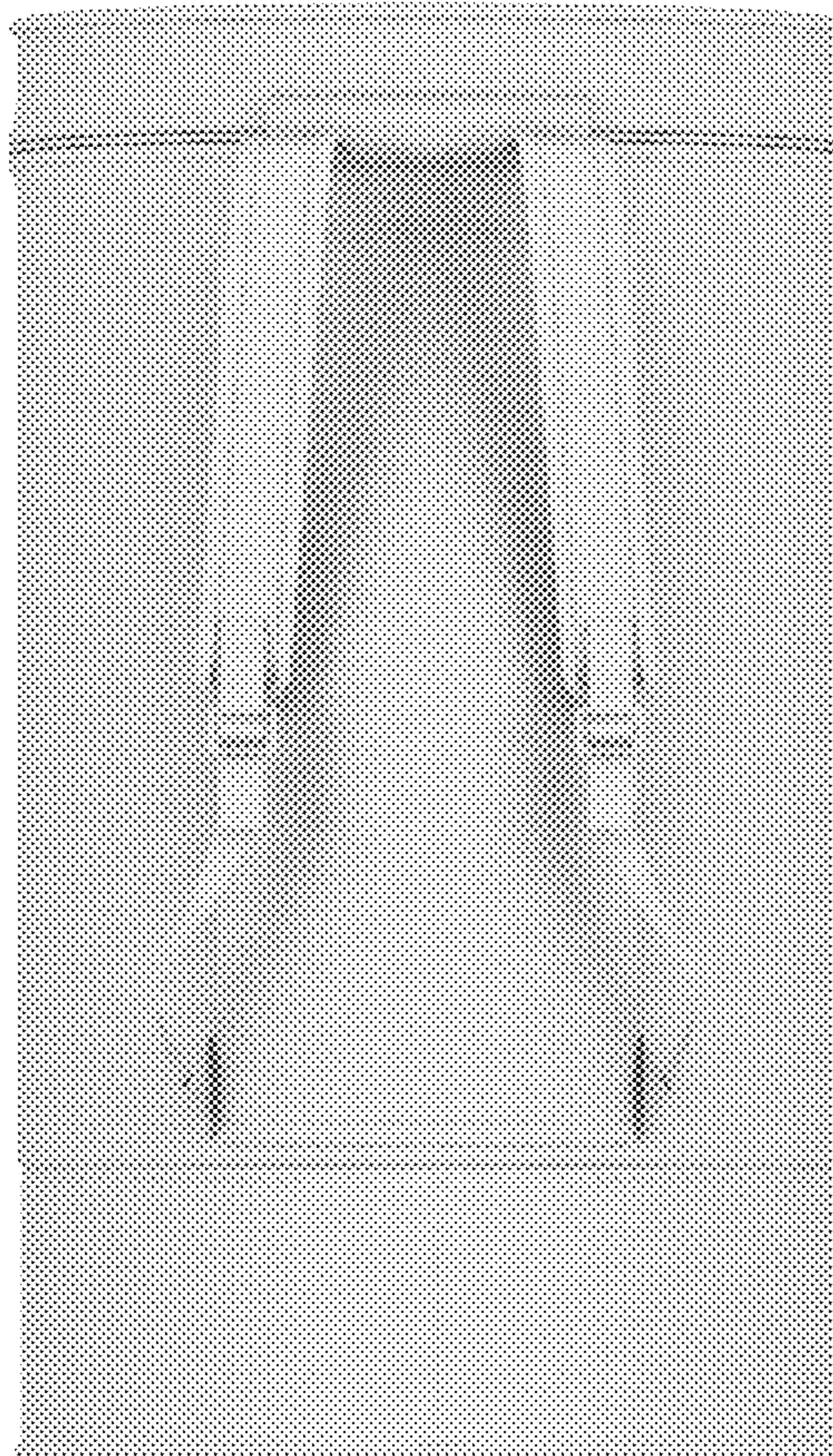

FIG. 3



FIG. 4

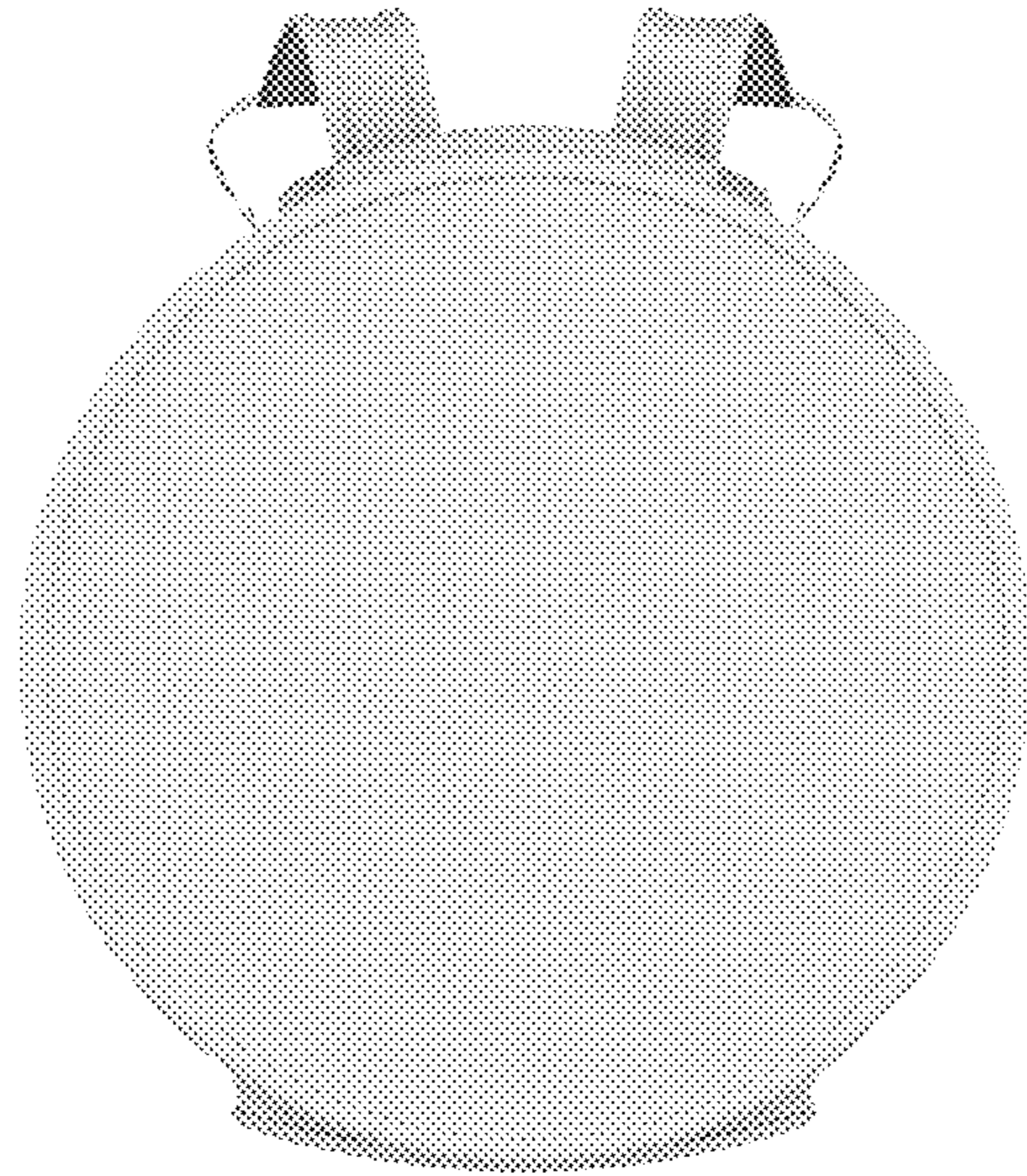

FIG. 5

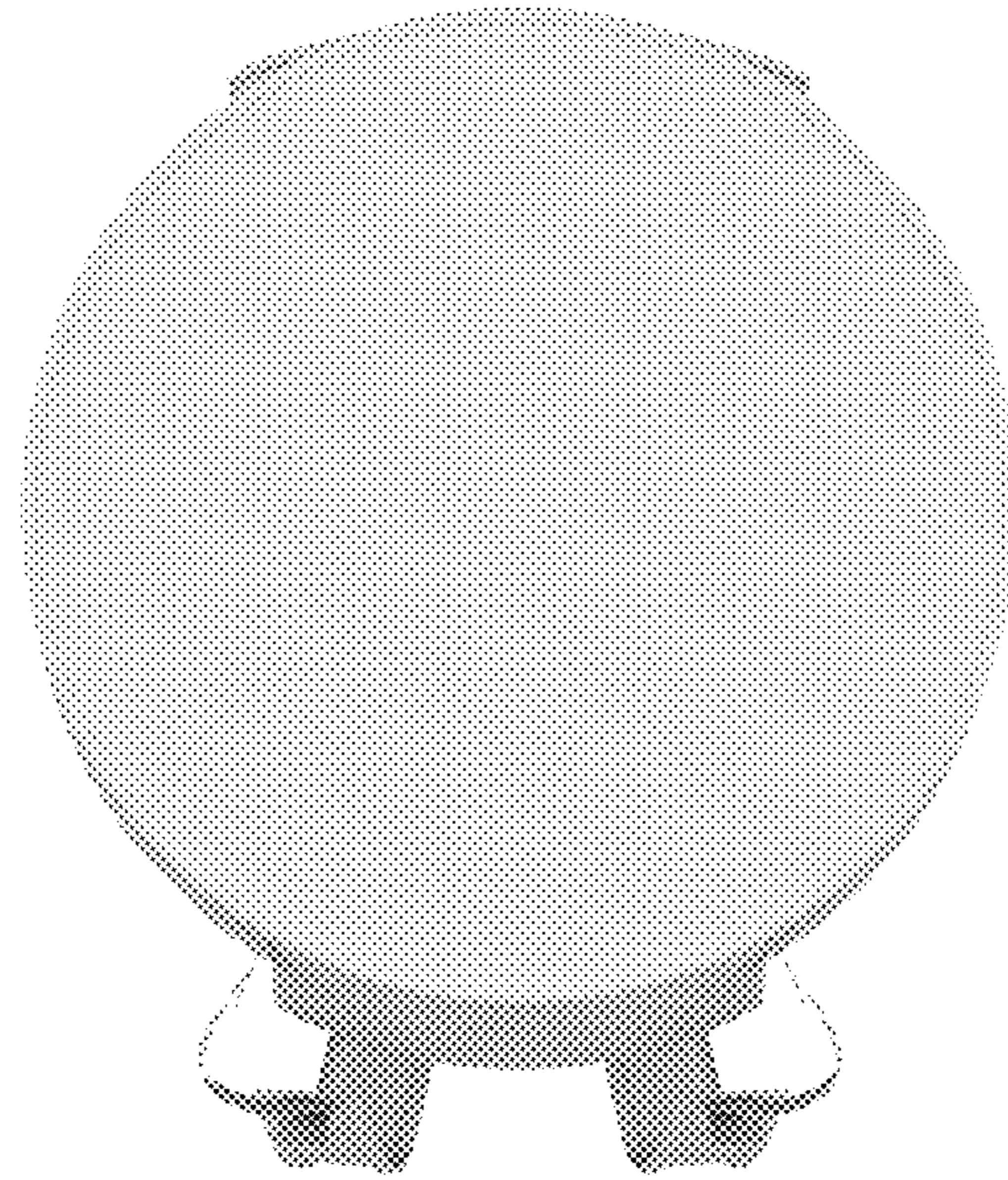

FIG. 6



FIG. 7



FIG. 8

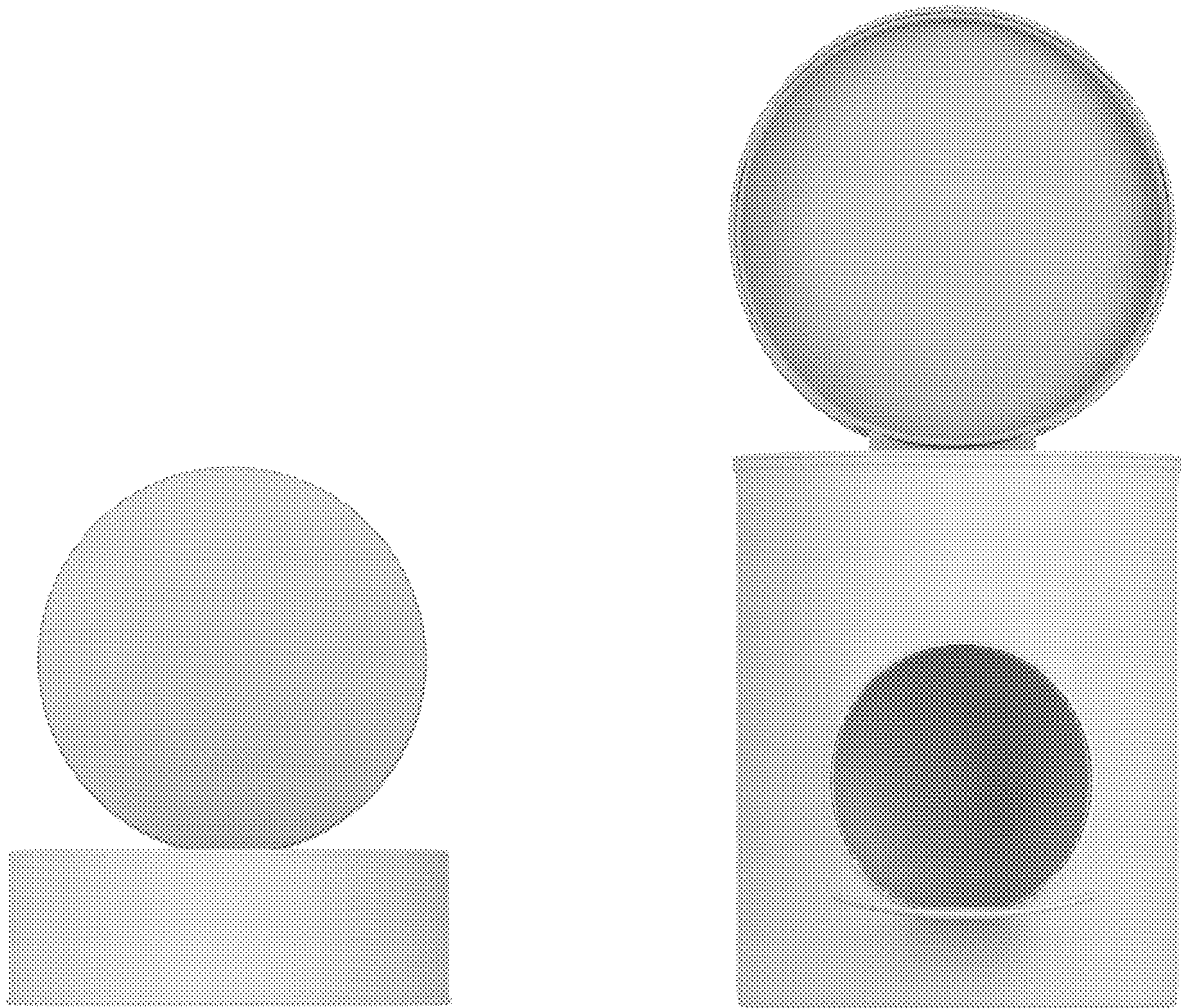

FIG. 9



FIG. 10

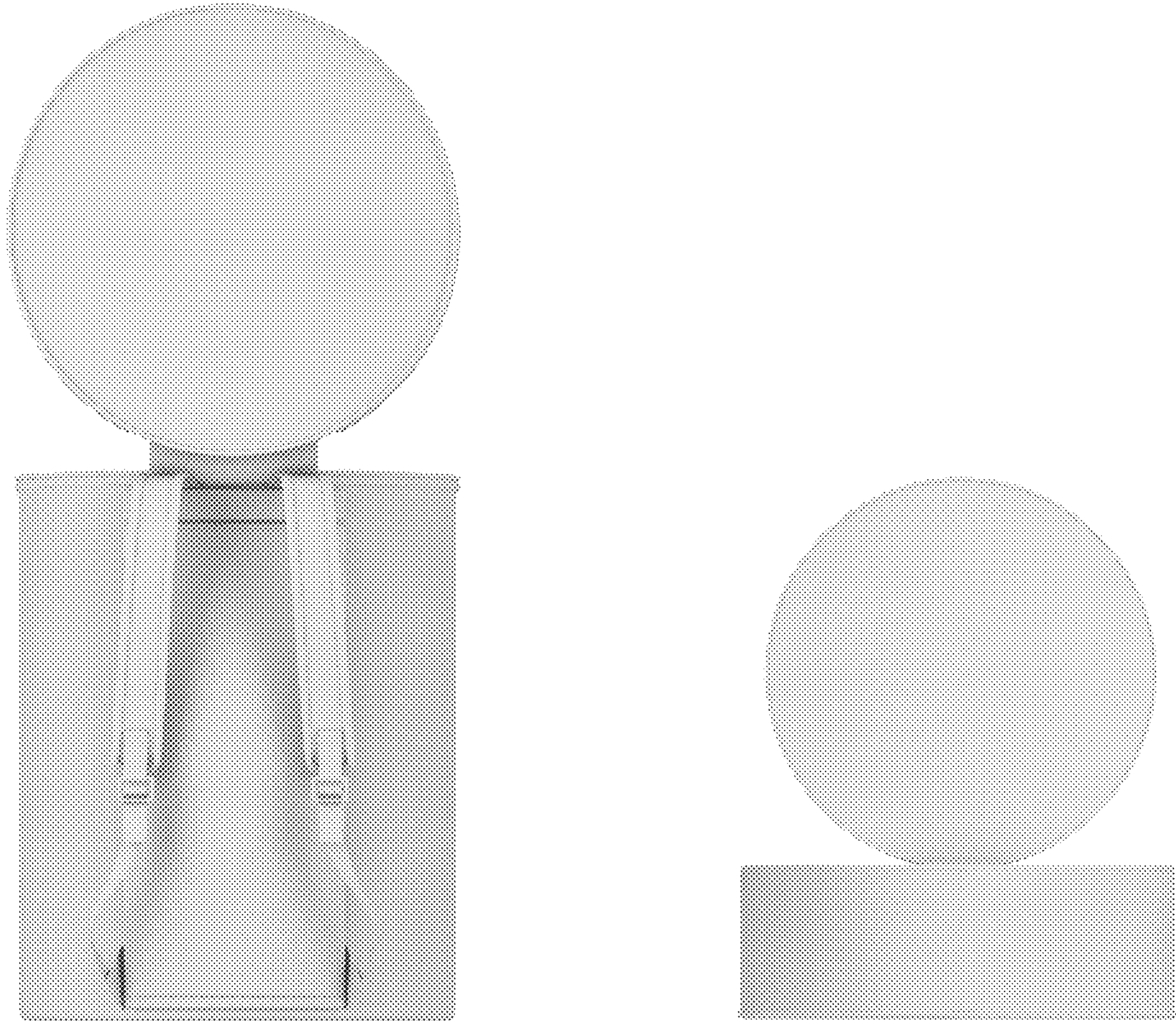

FIG. 11



FIG. 12

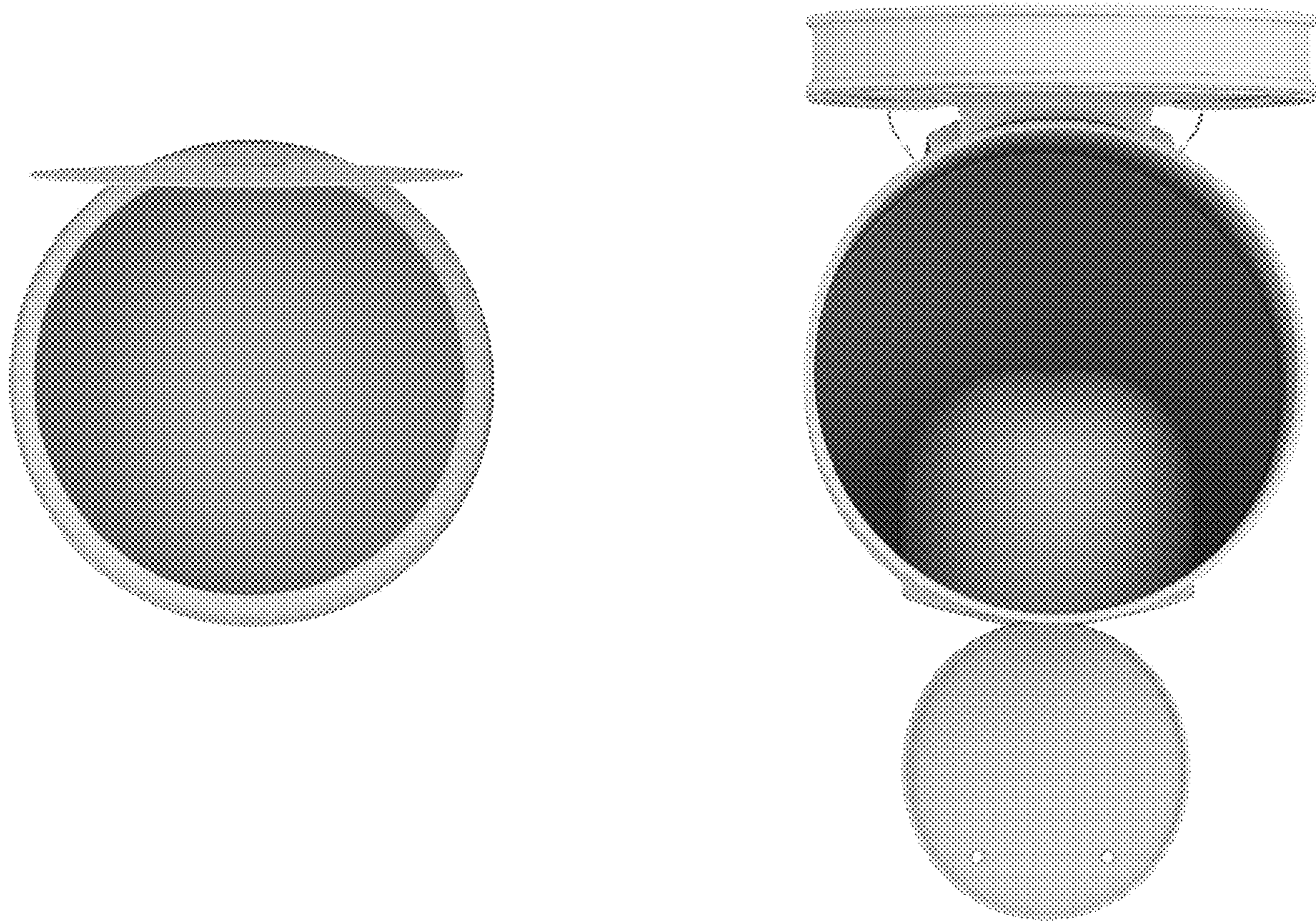

FIG. 13

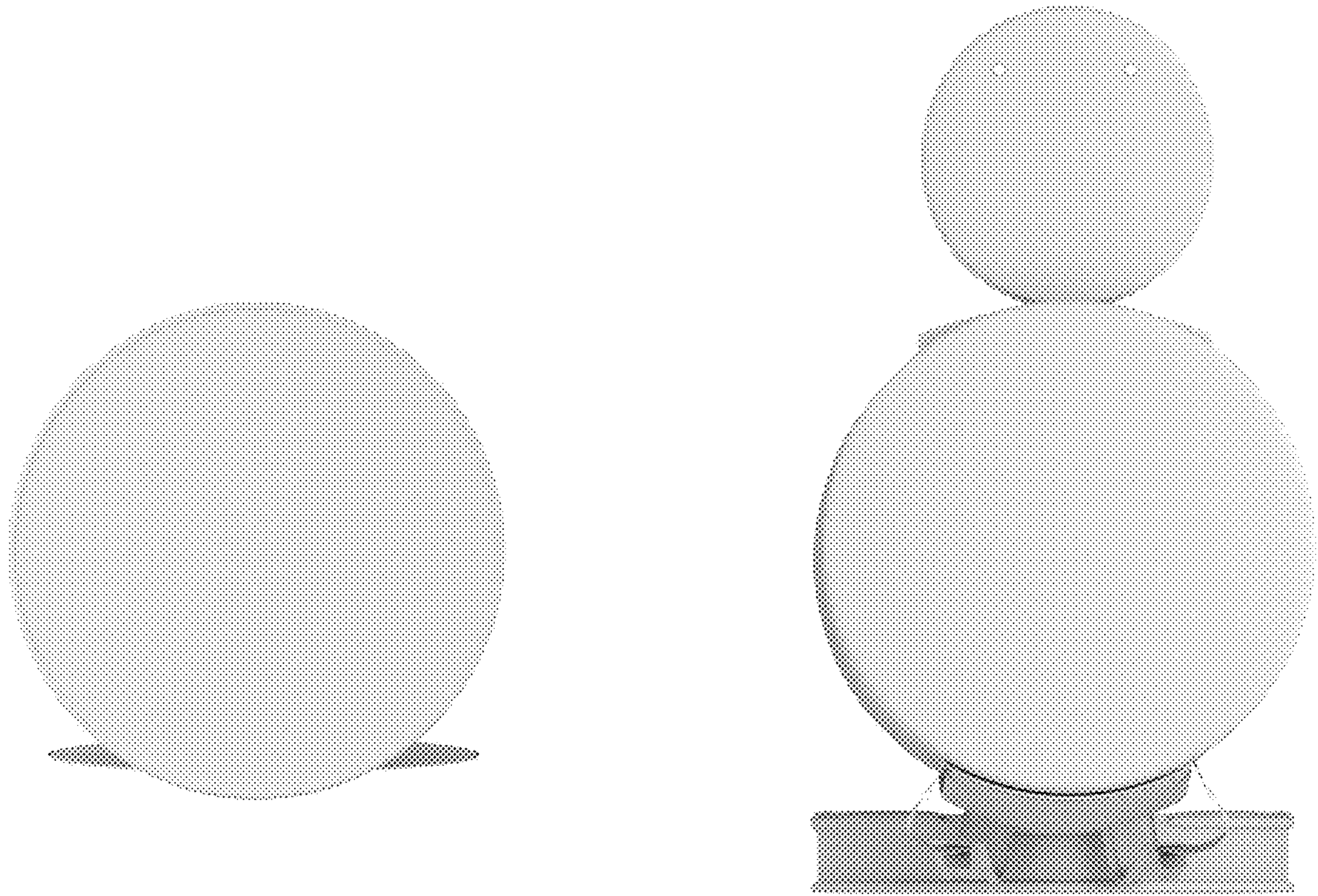

FIG. 14



FIG. 15



FIG. 16