



US00D873523S

(12) **United States Design Patent**  
**Muth**

(10) **Patent No.:** **US D873,523 S**  
(45) **Date of Patent:** **\*\* Jan. 21, 2020**

(54) **PLATFORM**

D793,024 S \* 7/2017 Bernart ..... D34/32  
D820,549 S \* 6/2018 Giannatti ..... D34/32  
D848,104 S \* 5/2019 Giannatti ..... D34/32

(71) Applicant: **CHAIN 'EM UP LLC**, Denver, CO  
(US)

(Continued)

(72) Inventor: **Norman Frank Muth**, Lakewood, CO  
(US)

**OTHER PUBLICATIONS**

(73) Assignee: **CHAIN 'EM UP LLC**, Denver, CO  
(US)

Chain 'em Up website search, <https://www.chainemup.com/product.html>; versatile utility tool searched Aug. 27, 2019 (Year: 2019).\*

(Continued)

(\*\*) Term: **15 Years**

*Primary Examiner* — Cynthia Ramirez

(21) Appl. No.: **29/669,685**

(74) *Attorney, Agent, or Firm* — Craig R. Miles; CR Miles P.C.

(22) Filed: **Nov. 9, 2018**

(57) **CLAIM**

**Related U.S. Application Data**

I claim the ornamental design for a platform, as shown and described.

(63) Continuation of application No. 15/659,211, filed on Jul. 25, 2017.

**DESCRIPTION**

(51) **LOC (12) Cl.** ..... **12-05**

(52) **U.S. Cl.**  
USPC ..... **D34/32**

(58) **Field of Classification Search**  
USPC ..... D34/32, 33  
CPC ..... B60P 1/43; B60P 1/435; B66F 7/243  
See application file for complete search history.

FIG. 1 is a perspective view of a platform in a closed condition, embodying our new design;  
FIG. 2 is a front elevation view thereof;  
FIG. 3 is a back elevation view thereof;  
FIG. 4 is a side elevation view thereof;  
FIG. 5 is another side elevation view thereof;  
FIG. 6 is a top plan view thereof;  
FIG. 7 is a bottom plan view thereof;  
FIG. 8 is a perspective view of the platform in an open condition;  
FIG. 9 is a front elevation view thereof;  
FIG. 10 is a back elevation view thereof;  
FIG. 11 is a first side elevation view thereof;  
FIG. 12 is second side elevation view thereof;  
FIG. 13 is a top plan view thereof; and,  
FIG. 14 is a bottom plan view thereof.

(56) **References Cited**

**U.S. PATENT DOCUMENTS**

3,510,015 A \* 5/1970 Roshaven ..... B60P 1/435  
414/537  
6,135,420 A \* 10/2000 Johnston ..... B66F 7/243  
254/88  
D550,922 S \* 9/2007 Bain ..... D34/32  
D595,920 S \* 7/2009 Lederhause ..... D34/32  
D646,043 S \* 9/2011 Woo ..... D34/32  
D663,092 S \* 7/2012 Blocker ..... D34/32  
D678,647 S \* 3/2013 Parras ..... D34/32  
D735,435 S \* 7/2015 Guido, III ..... D34/32  
D756,573 S \* 5/2016 Jakubowski ..... D30/199

The broken lines shown are included for the purpose of illustrating the unclaimed portions of the article and form no part of the claim.

**1 Claim, 8 Drawing Sheets**

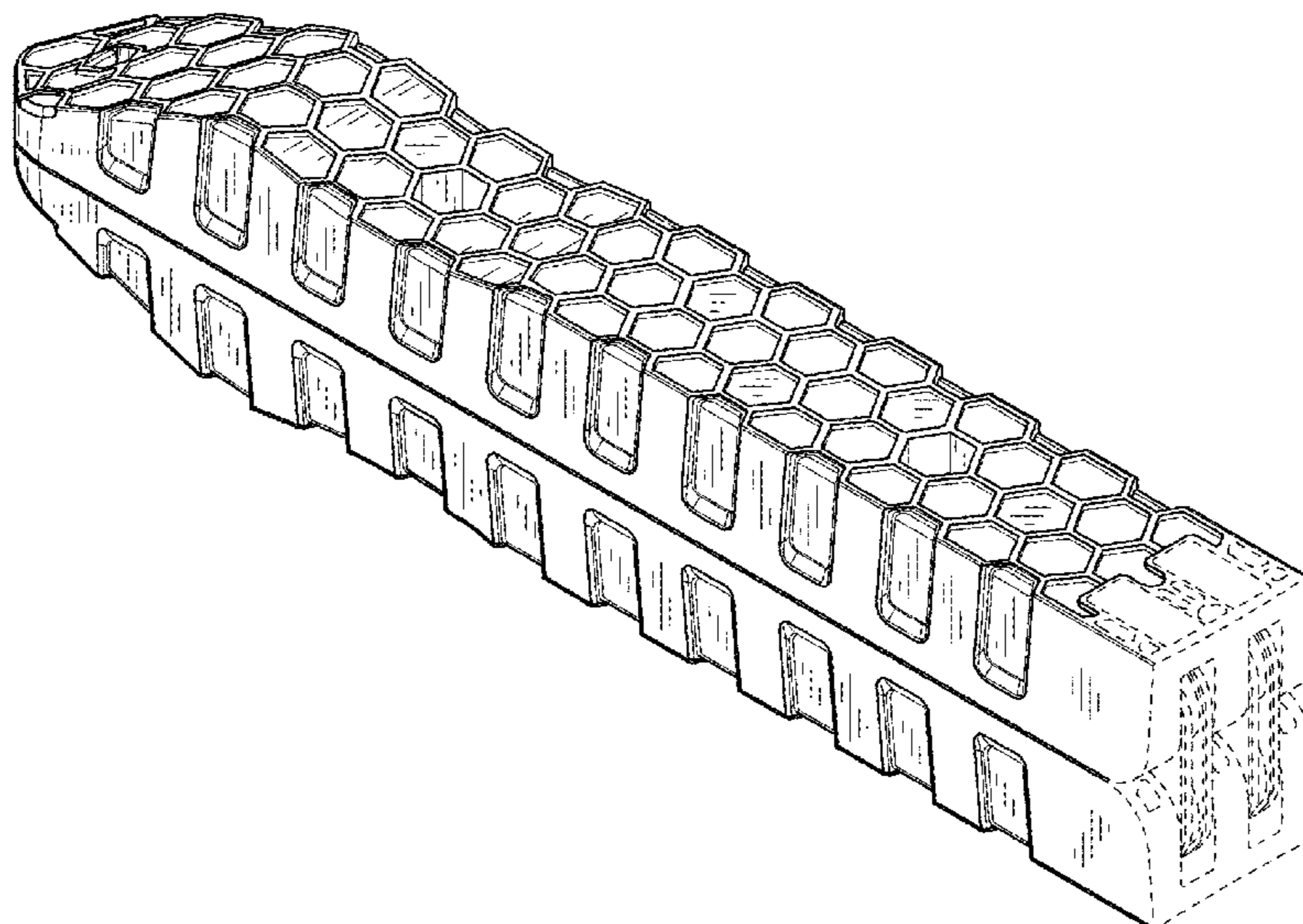

(56)

**References Cited**

U.S. PATENT DOCUMENTS

2003/0213072 A1\* 11/2003 Myrick ..... B60P 1/43  
14/69.5  
2006/0056944 A1\* 3/2006 Henblad ..... B60P 3/077  
414/401  
2013/0091639 A1\* 4/2013 Romanak ..... B60P 1/43  
14/71.1  
2018/0029856 A1\* 2/2018 Muth ..... B66F 7/243

OTHER PUBLICATIONS

U.S. Appl. No. 62/366,727, filed Jul. 26, 2016.

U.S. Appl. No. 15/659,211, filed Jul. 25, 2017.

\* cited by examiner

FIG. 1

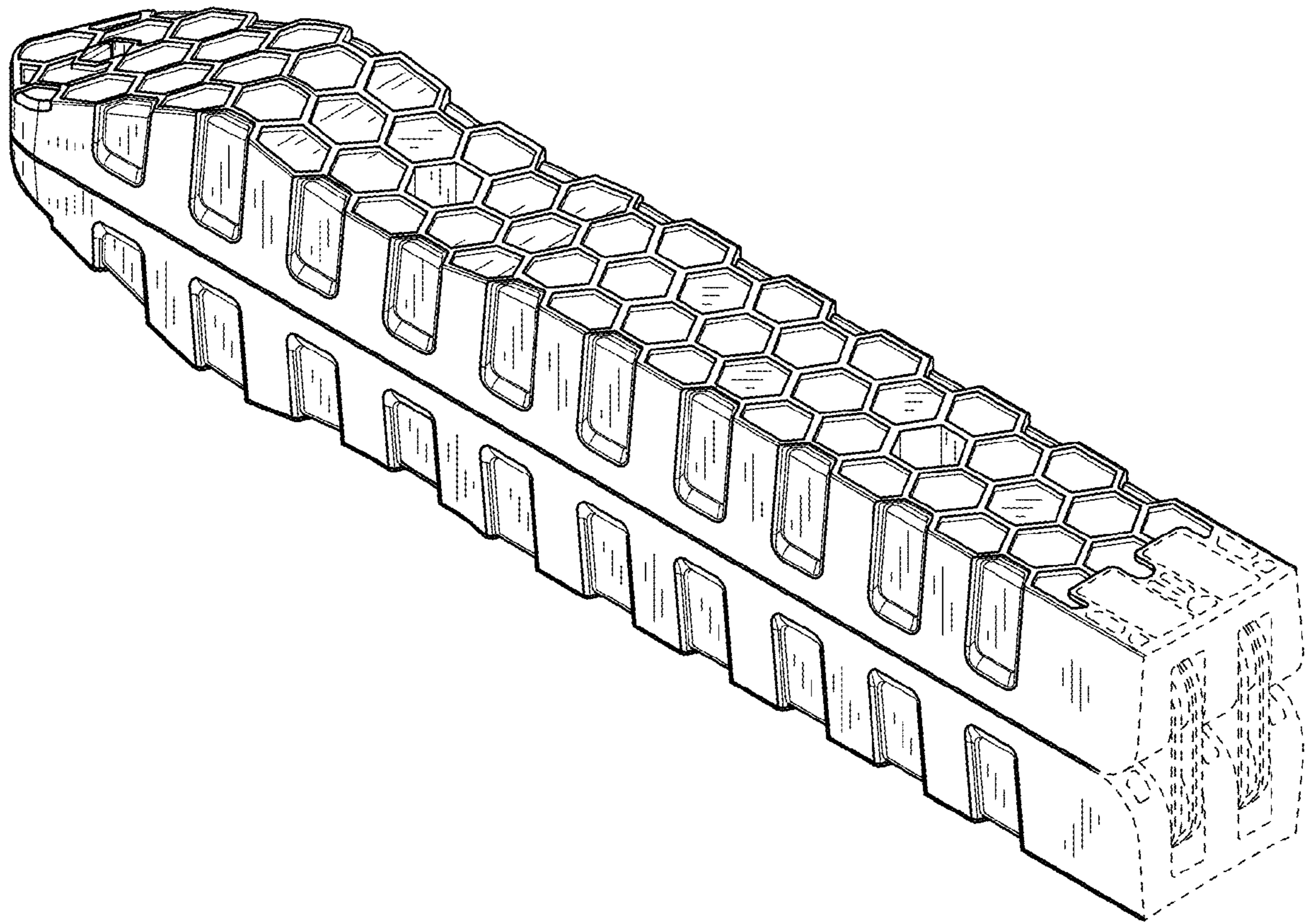

FIG. 2

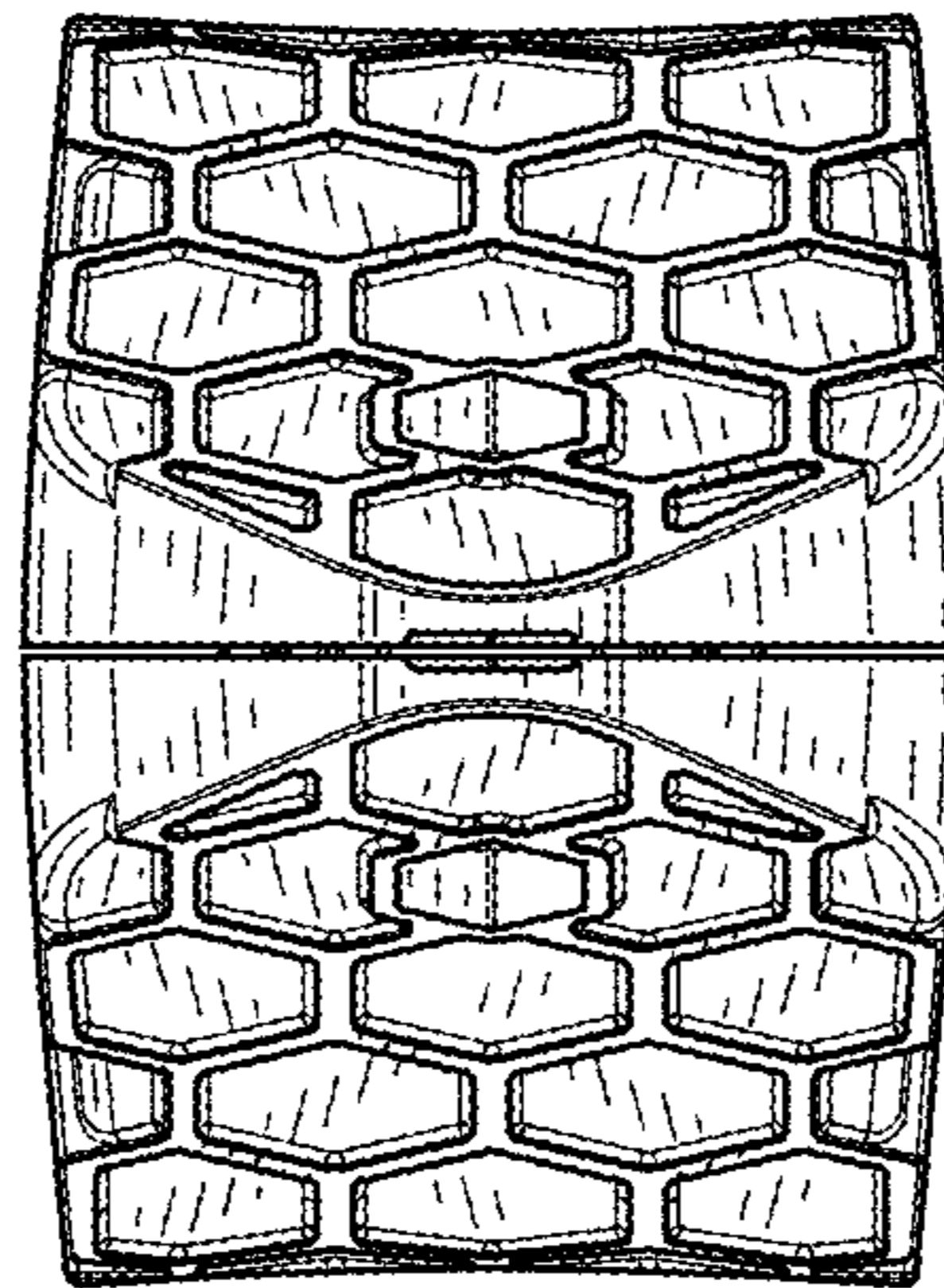

FIG. 3

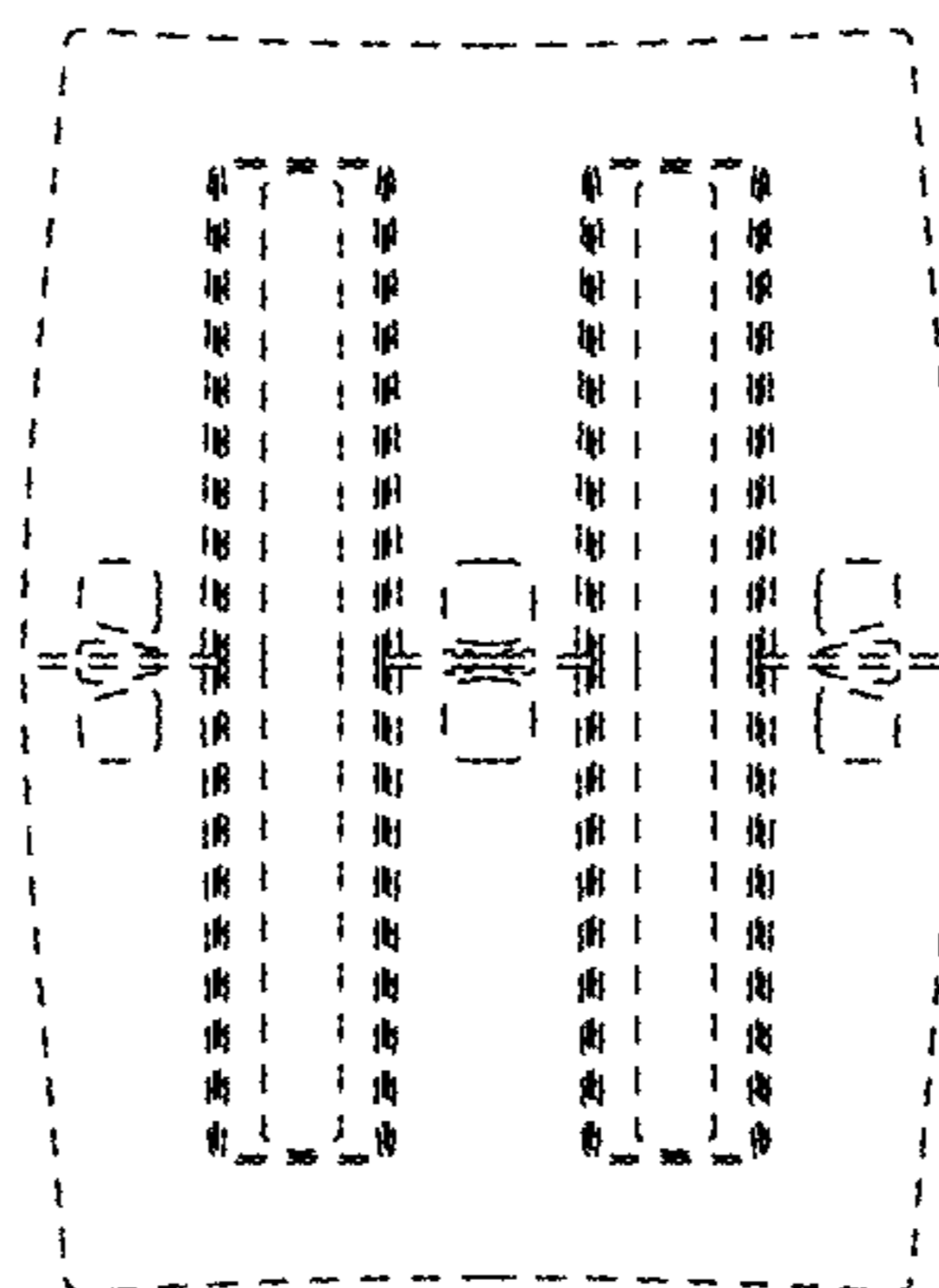

FIG. 4

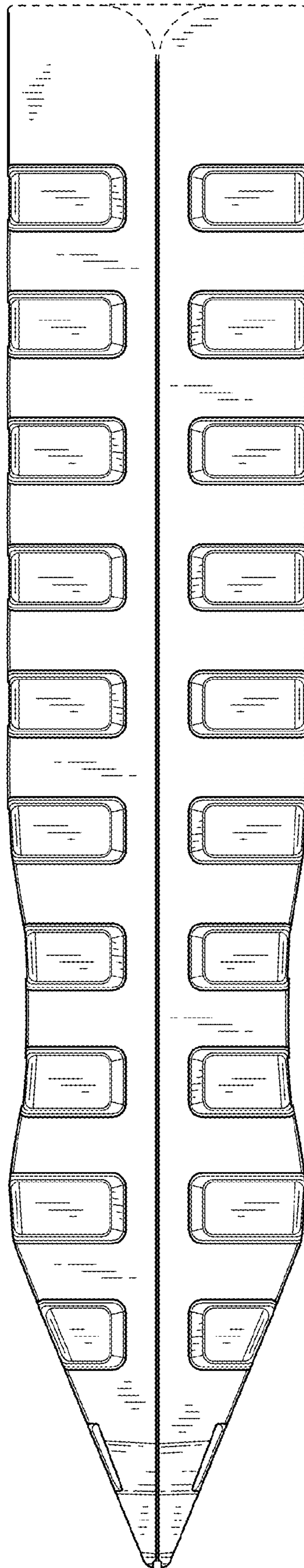

FIG. 5

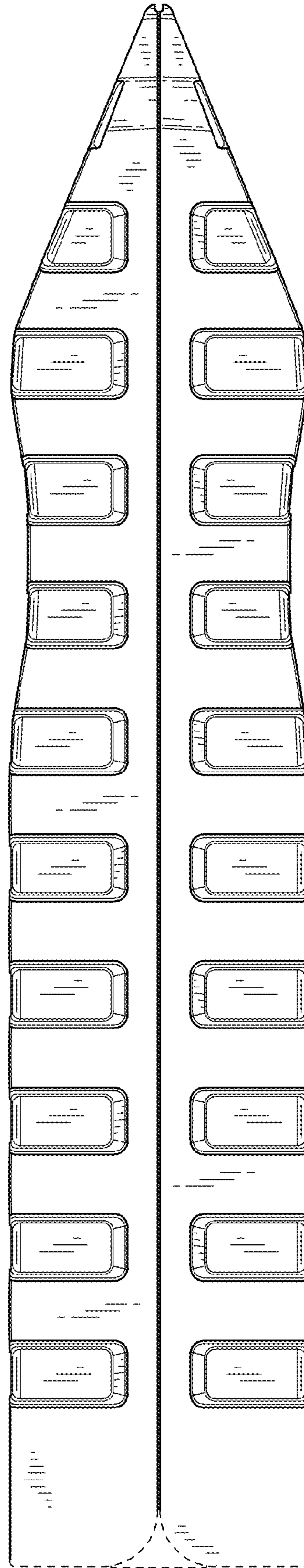

FIG. 6

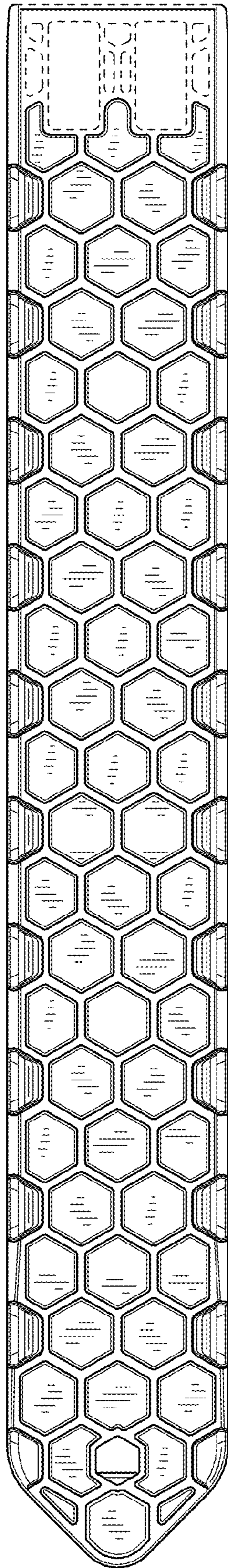
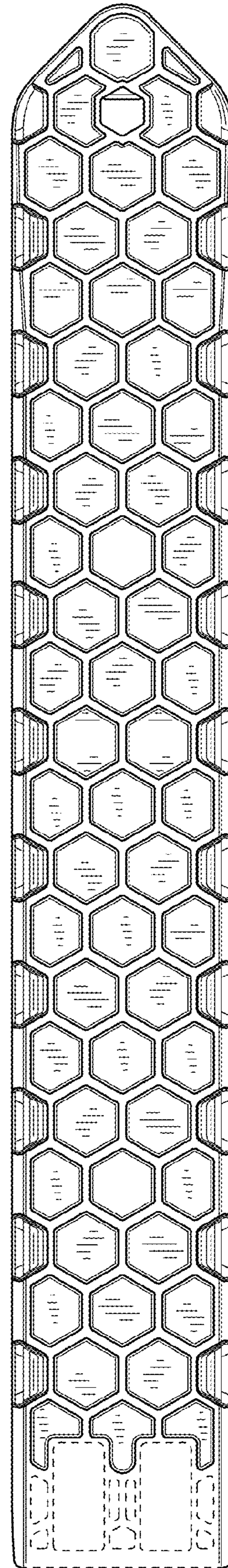

FIG. 7



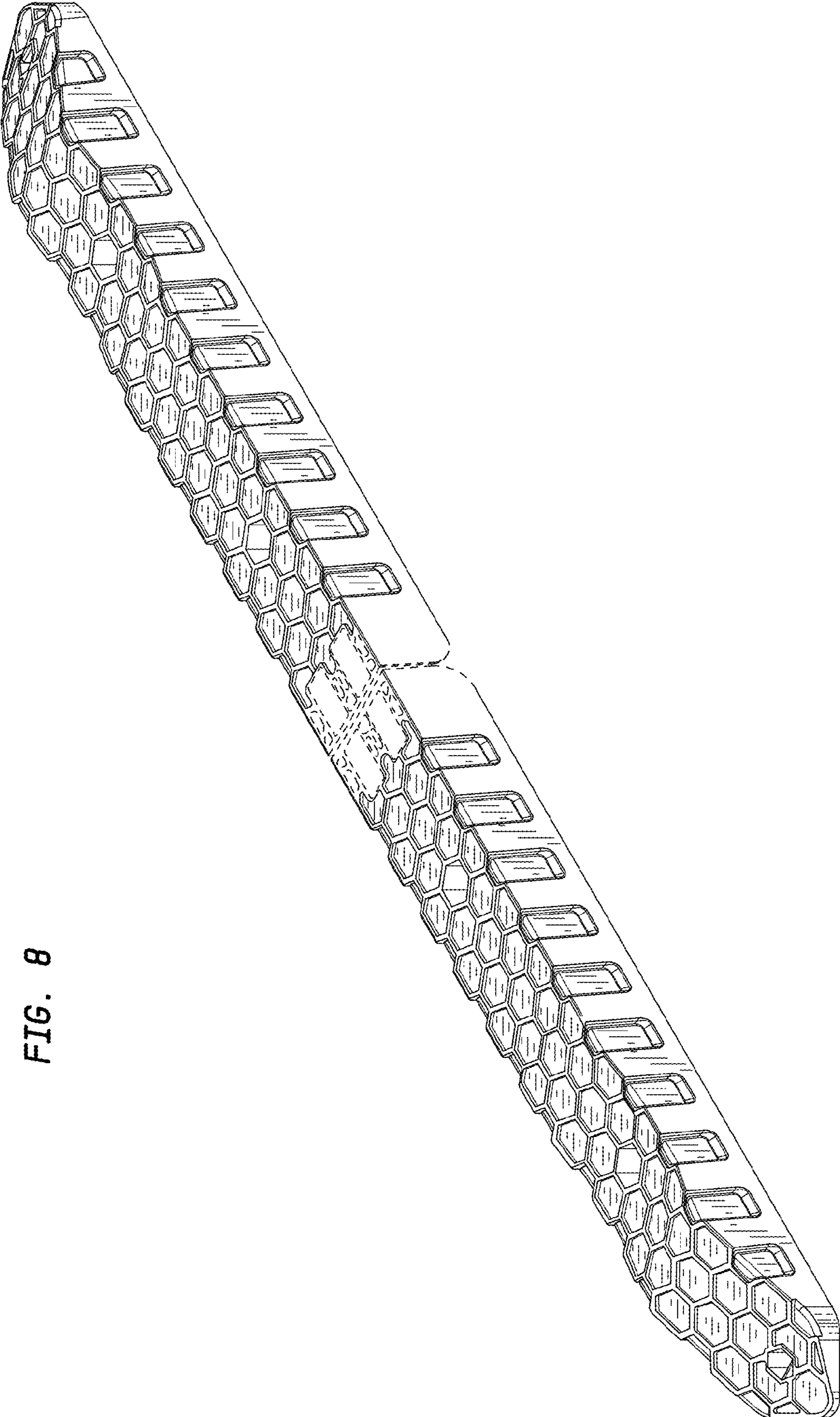
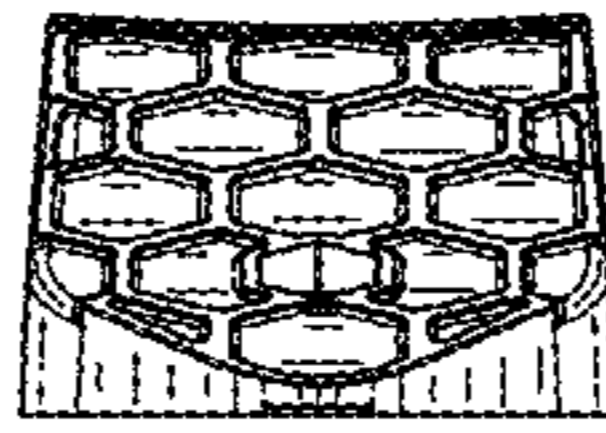

FIG. 8

*FIG. 9*



*FIG. 10*

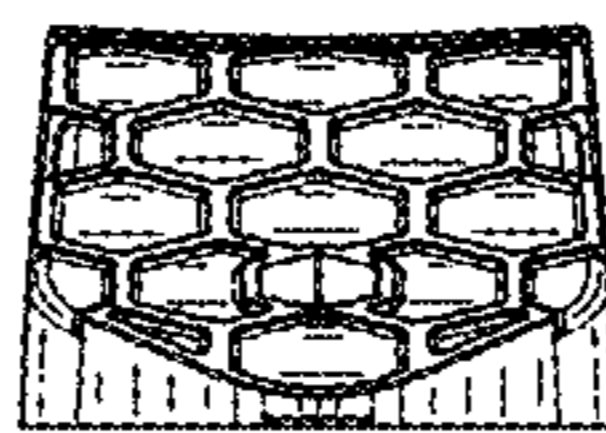



FIG. 11

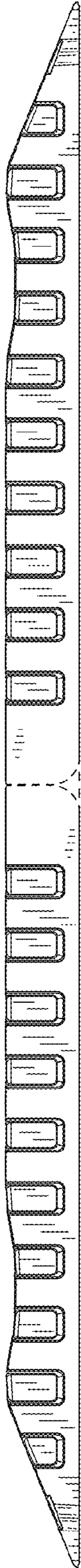

FIG. 12

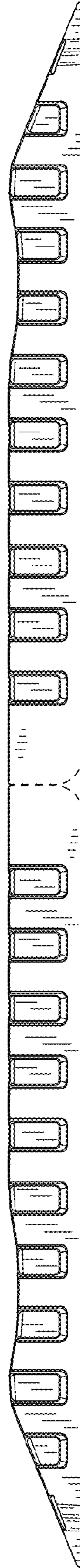

FIG. 13

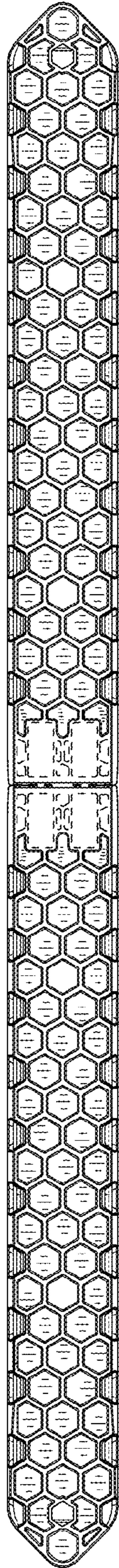

FIG. 14

