



US00D873495S

(12) **United States Design Patent**  
**Von Heifner et al.**

(10) **Patent No.:** **US D873,495 S**  
(45) **Date of Patent:** **\*\* Jan. 21, 2020**

(54) **COLLAPSIBLE HELMET**

- (71) Applicant: **FEND Corp.**, New York, NY (US)
- (72) Inventors: **Christian Von Heifner**, New York, NY (US); **Sujene Park Kong**, New York, NY (US)
- (73) Assignee: **FEND Corp.**, New York, NY (US)
- (\*\*) Term: **15 Years**
- (21) Appl. No.: **29/611,748**
- (22) Filed: **Jul. 25, 2017**

**Related U.S. Application Data**

- (63) Continuation-in-part of application No. 29/610,170, filed on Jul. 10, 2017.
- (51) **LOC (12) Cl.** ..... **09-03**
- (52) **U.S. Cl.**  
USPC ..... **D29/102**
- (58) **Field of Classification Search**  
USPC ..... D29/102-110, 112, 122; D2/869, 870; 358/471; D16/208  
CPC .. A63B 71/10; A42B 3/00; A42B 3/18; A42B 3/20; A42B 3/185; A42B 3/225; A42B 3/121; A42B 3/12; A42B 3/0406; A42B 3/10; A42B 3/322; A42B 1/04; A42B 1/041; A61F 9/06  
See application file for complete search history.

(56) **References Cited**

**U.S. PATENT DOCUMENTS**

- D427,727 S \* 7/2000 Ho ..... D29/102
  - D445,218 S \* 7/2001 Watters ..... D29/102
- (Continued)

**FOREIGN PATENT DOCUMENTS**

- KR 20160127932 11/2016
- WO WO-2016142640 9/2016

**OTHER PUBLICATIONS**

Morpher Hemlet, "Flat-Folding Morpher Helmet", <https://www.morpherhelmet.com/>, 2017, 8 pages.  
(Continued)

*Primary Examiner* — Ruth McInroy  
(74) *Attorney, Agent, or Firm* — Strategic Patents, P.C.

(57) **CLAIM**

The ornamental design for a collapsible helmet, as shown and described.

**DESCRIPTION**

FIG. 1 is a top, front perspective view of a design for a collapsible helmet;  
 FIG. 2 is a front view thereof;  
 FIG. 3 is a rear view thereof;  
 FIG. 4 is a left side view thereof;  
 FIG. 5 is a right side view thereof;  
 FIG. 6 is a top view thereof;  
 FIG. 7 is a bottom view thereof;  
 FIG. 8 is a top, rear perspective view thereof;  
 FIG. 9 is a bottom, front perspective view thereof;  
 FIG. 10 is a bottom, rear perspective view thereof;  
 FIG. 11 is a top, front perspective view thereof, in a collapsed position;  
 FIG. 12 is a front view of FIG. 11;  
 FIG. 13 is a rear view of FIG. 11;  
 FIG. 14 is a left side view of FIG. 11;  
 FIG. 15 is a right side view of FIG. 11;  
 FIG. 16 is a top view of FIG. 11;  
 FIG. 17 is a bottom view of FIG. 11;  
 FIG. 18 is a top, rear perspective view of FIG. 11;  
 FIG. 19 is a bottom, front perspective view of FIG. 11; and,  
 FIG. 20 is a bottom, rear perspective view of FIG. 11.  
 The details shown in broken lines are for illustrative purposes only and form no part of the claimed design.

**1 Claim, 20 Drawing Sheets**

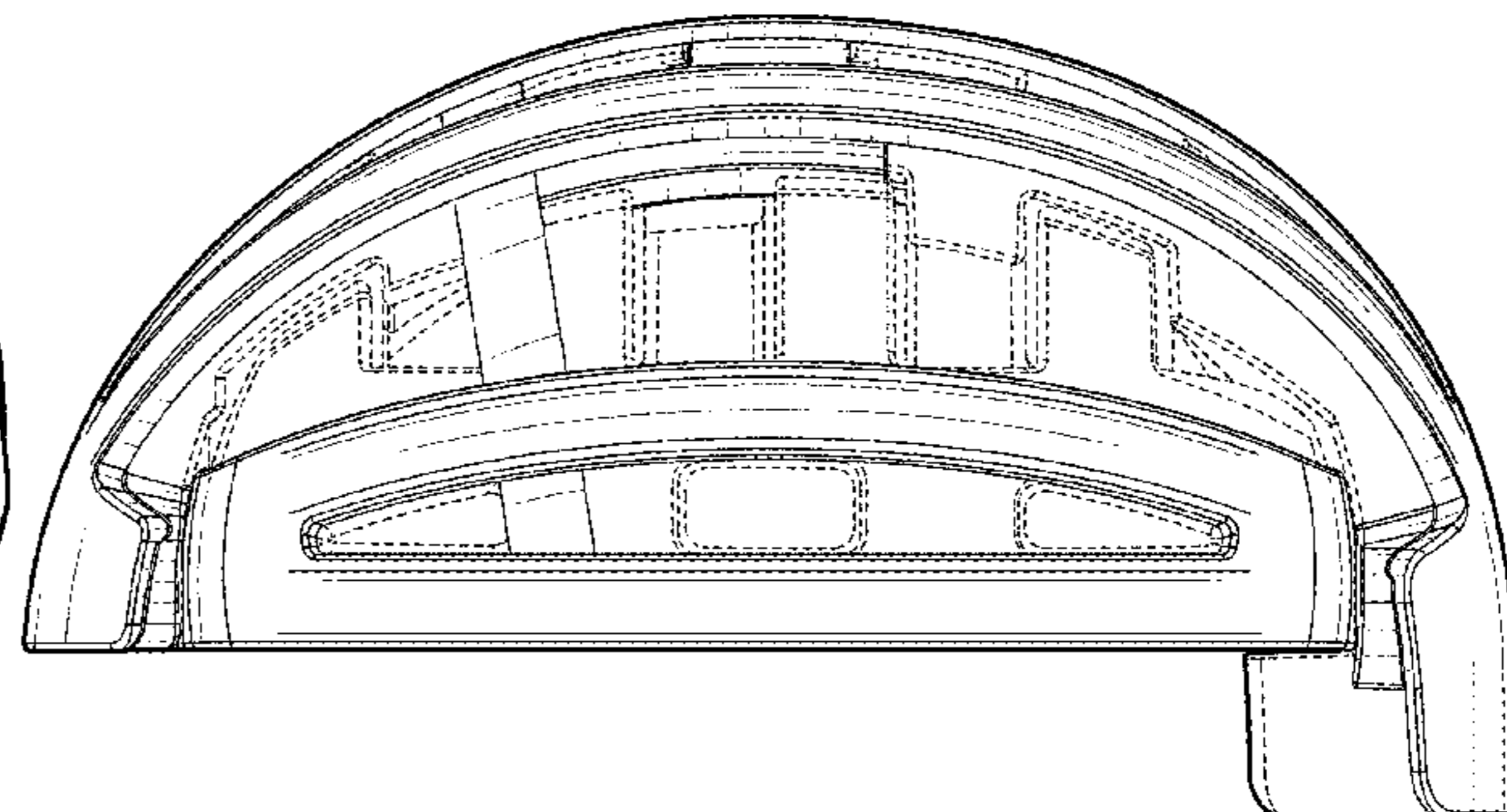
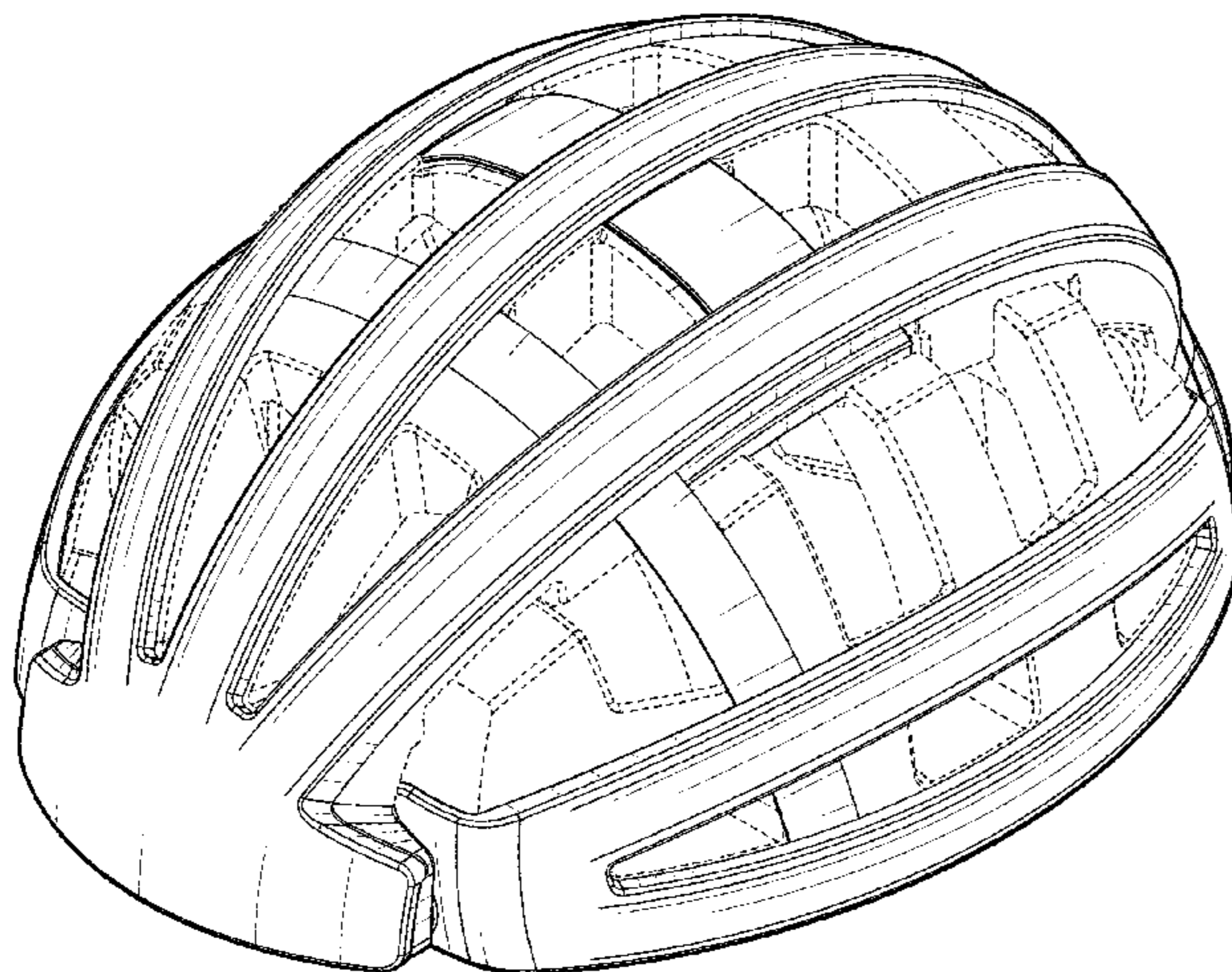

(56)

**References Cited**

U.S. PATENT DOCUMENTS

D482,501 S \* 11/2003 Ho ..... D29/102  
D547,499 S \* 7/2007 Chen ..... D29/102  
D553,300 S \* 10/2007 Navarra ..... D29/102  
7,958,572 B2 6/2011 Loury et al.  
D678,616 S \* 3/2013 Norton ..... D29/102  
D697,267 S \* 1/2014 Benvegna' ..... D29/102  
D724,788 S \* 3/2015 Woxing ..... D29/102  
D759,899 S \* 6/2016 Finiel ..... D29/102  
D773,120 S \* 11/2016 Storey ..... D29/102  
9,554,611 B2 1/2017 Arrouart et al.  
9,585,432 B2 \* 3/2017 Garneau ..... A42B 3/062

OTHER PUBLICATIONS

Carrera, "Foldable Crit", <http://www.carreraworld.com/it/it/sport/car/2015/FOLDABLE-CRIT.E004969EV5558.html>, 2016, 2 pages.  
Overade, "Foldable Helmet", <https://www.overade.com/shop/en/>, 2016, 6 Pages.

\* cited by examiner

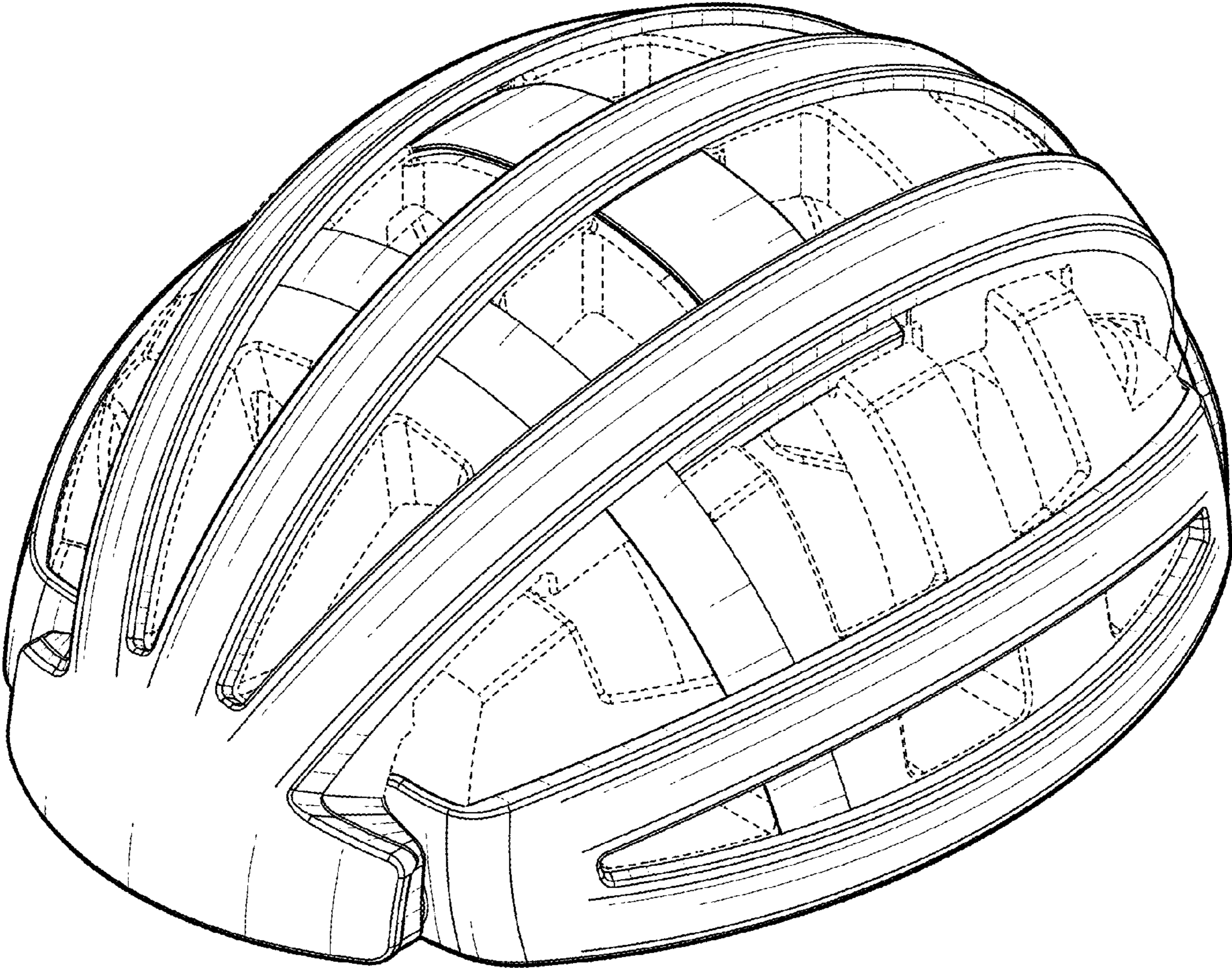

FIG. 1

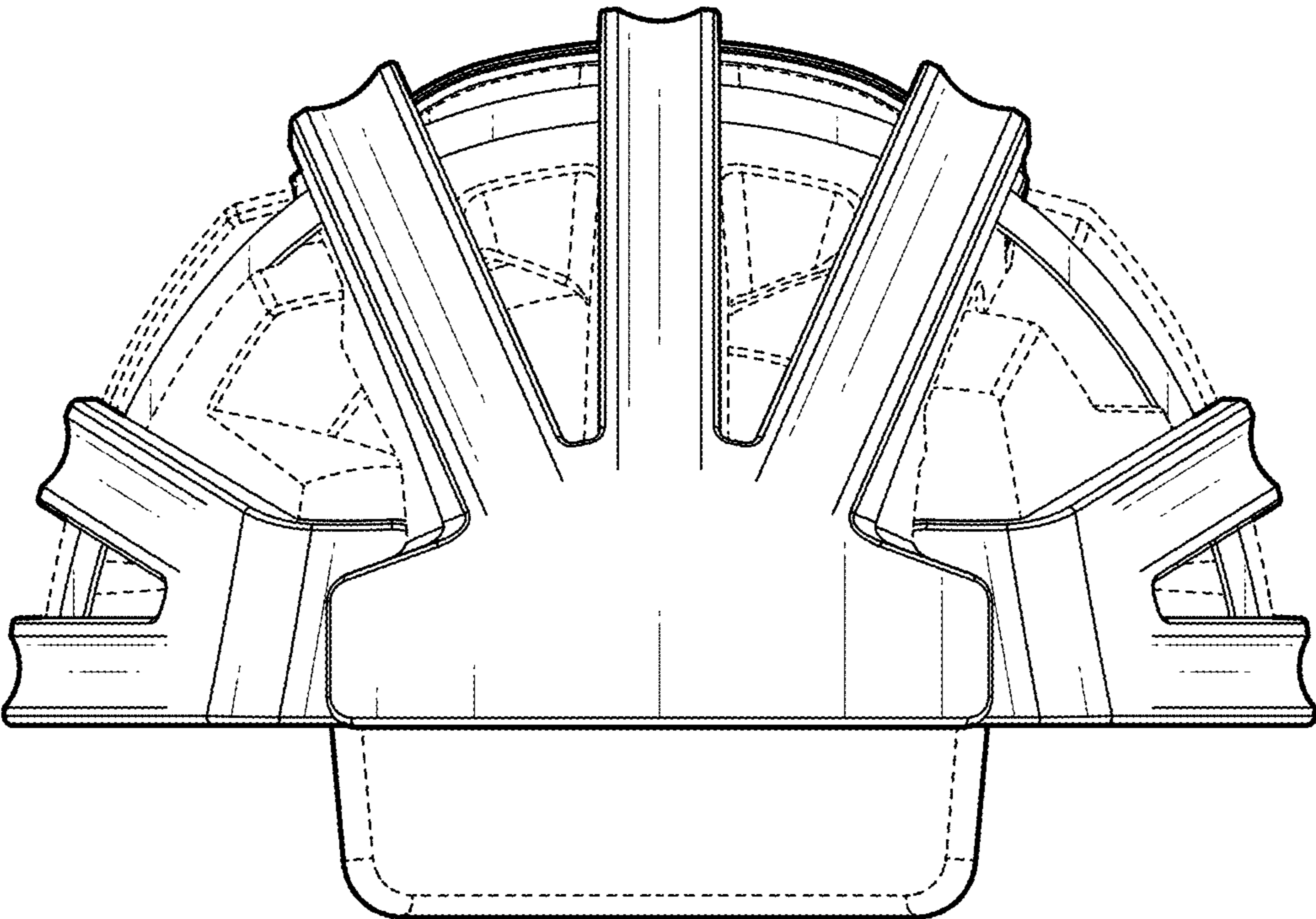

FIG. 2

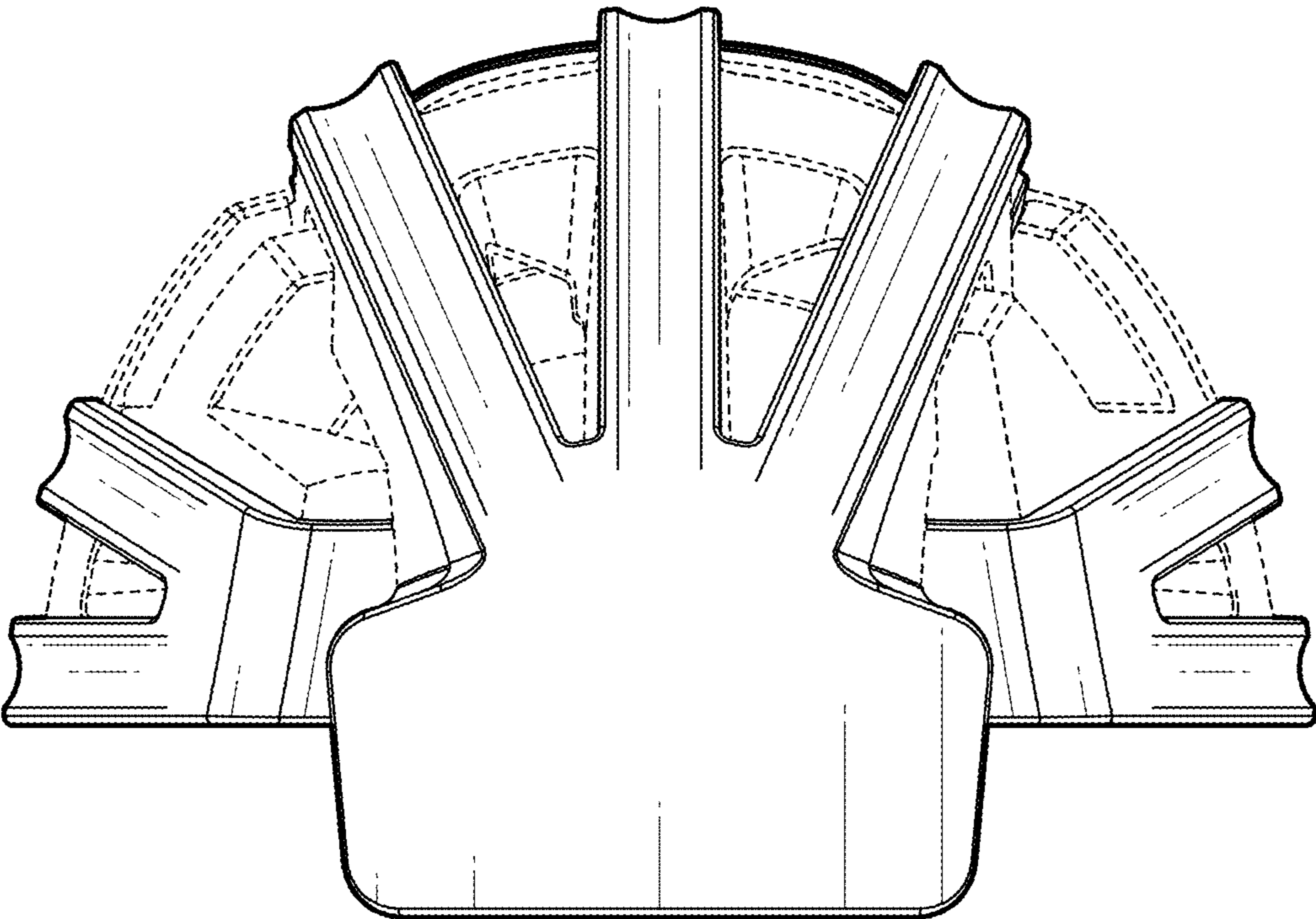

FIG. 3

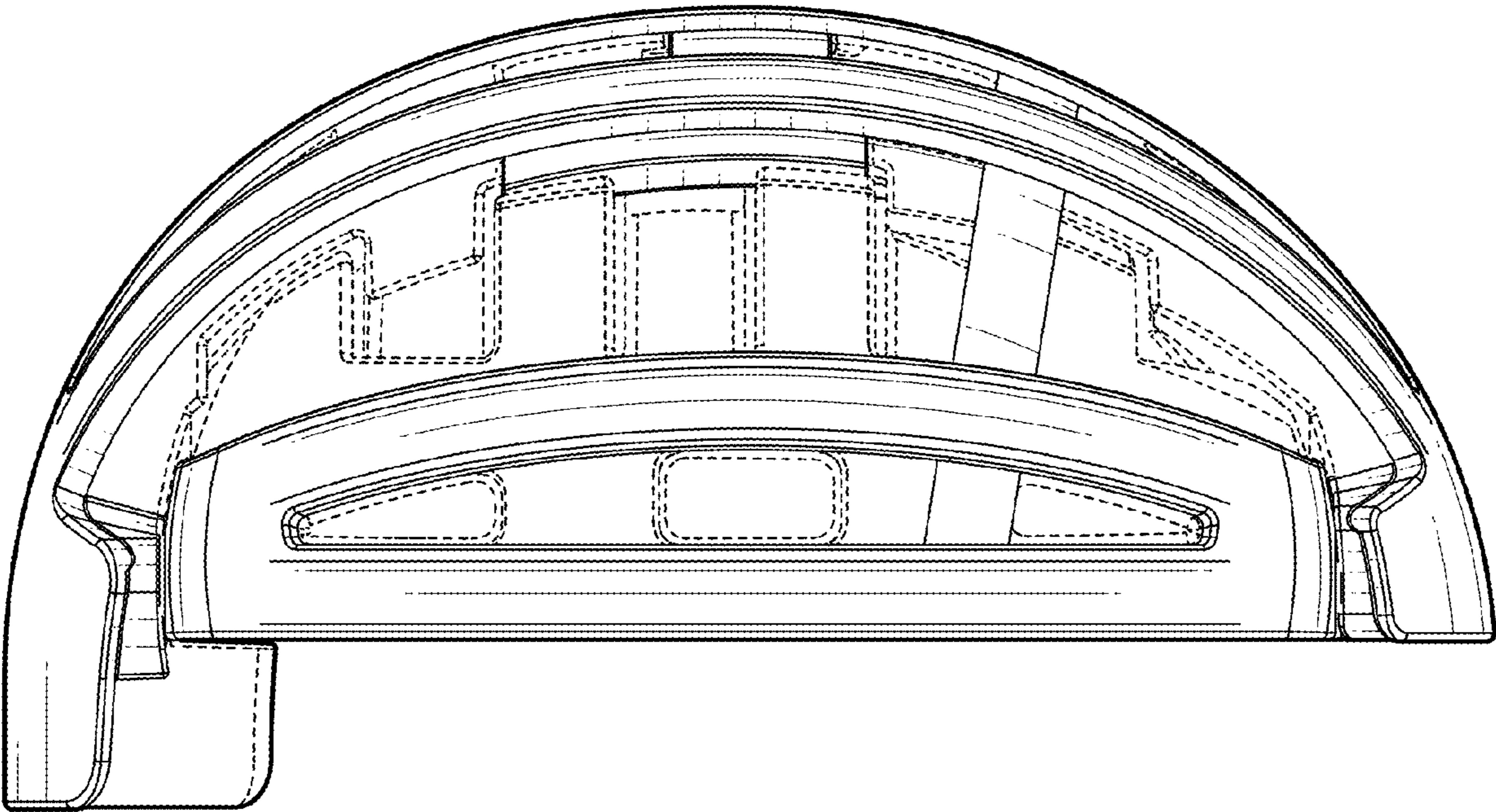

FIG. 4

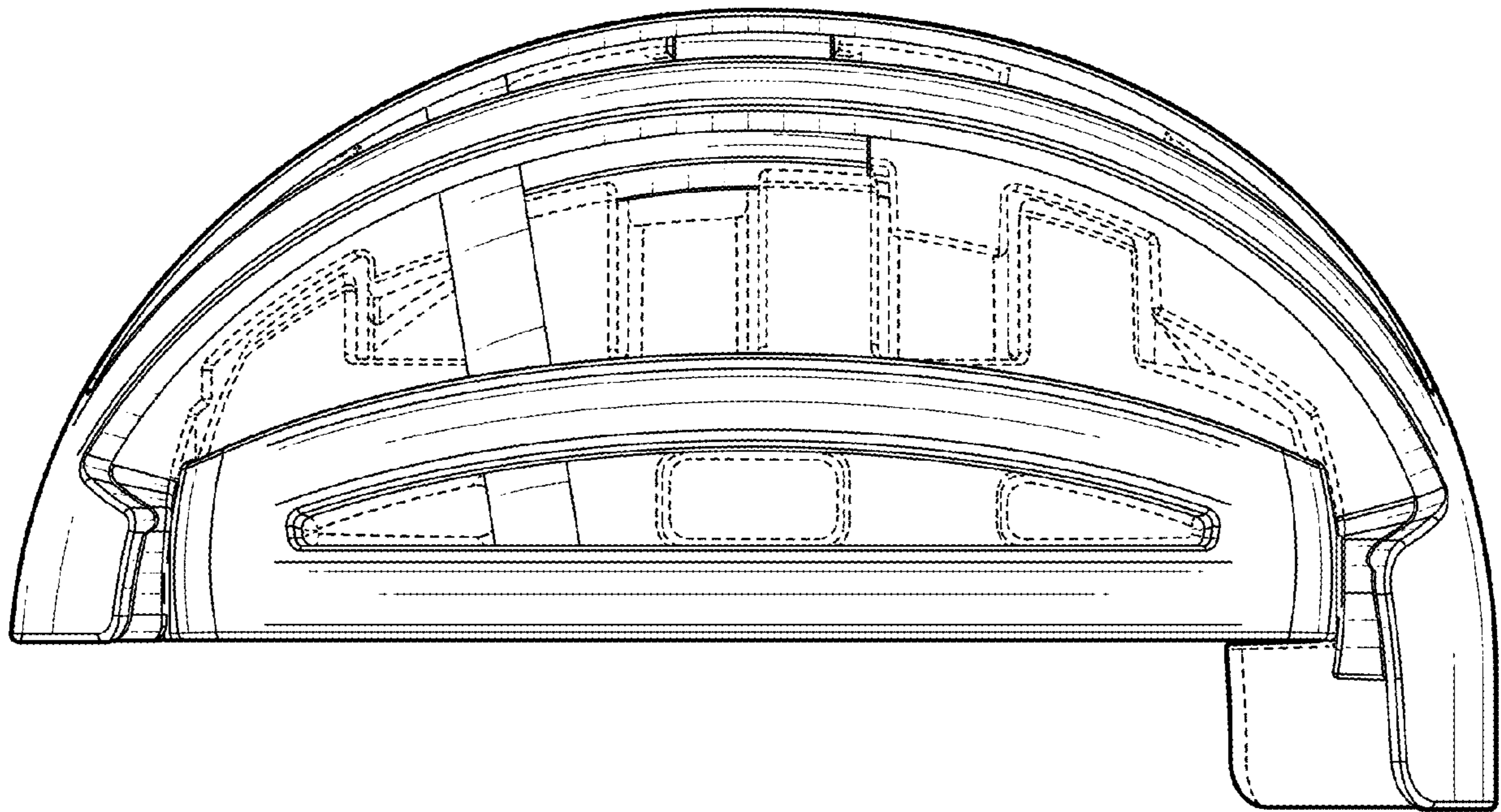

FIG. 5

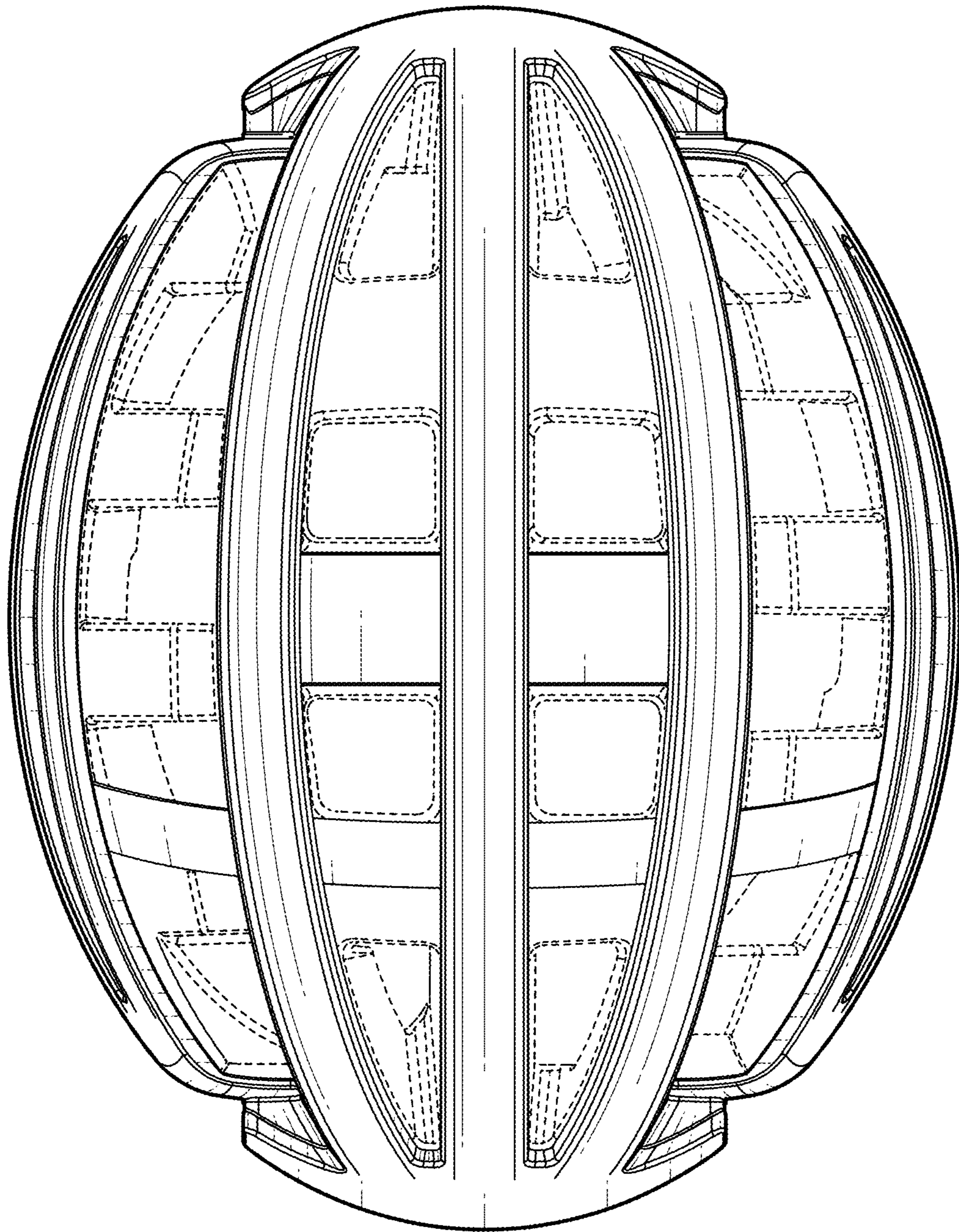

FIG. 6



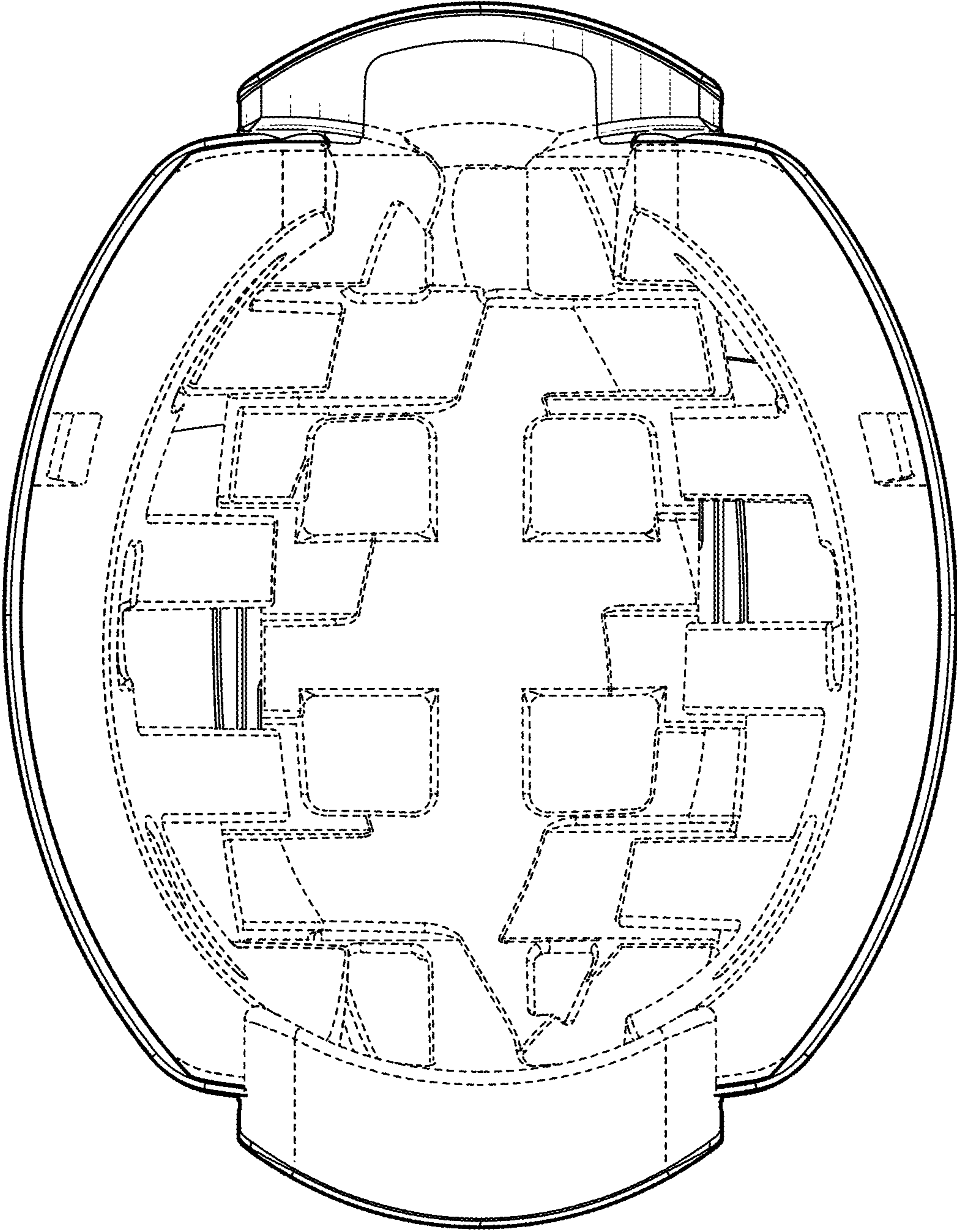

FIG. 7

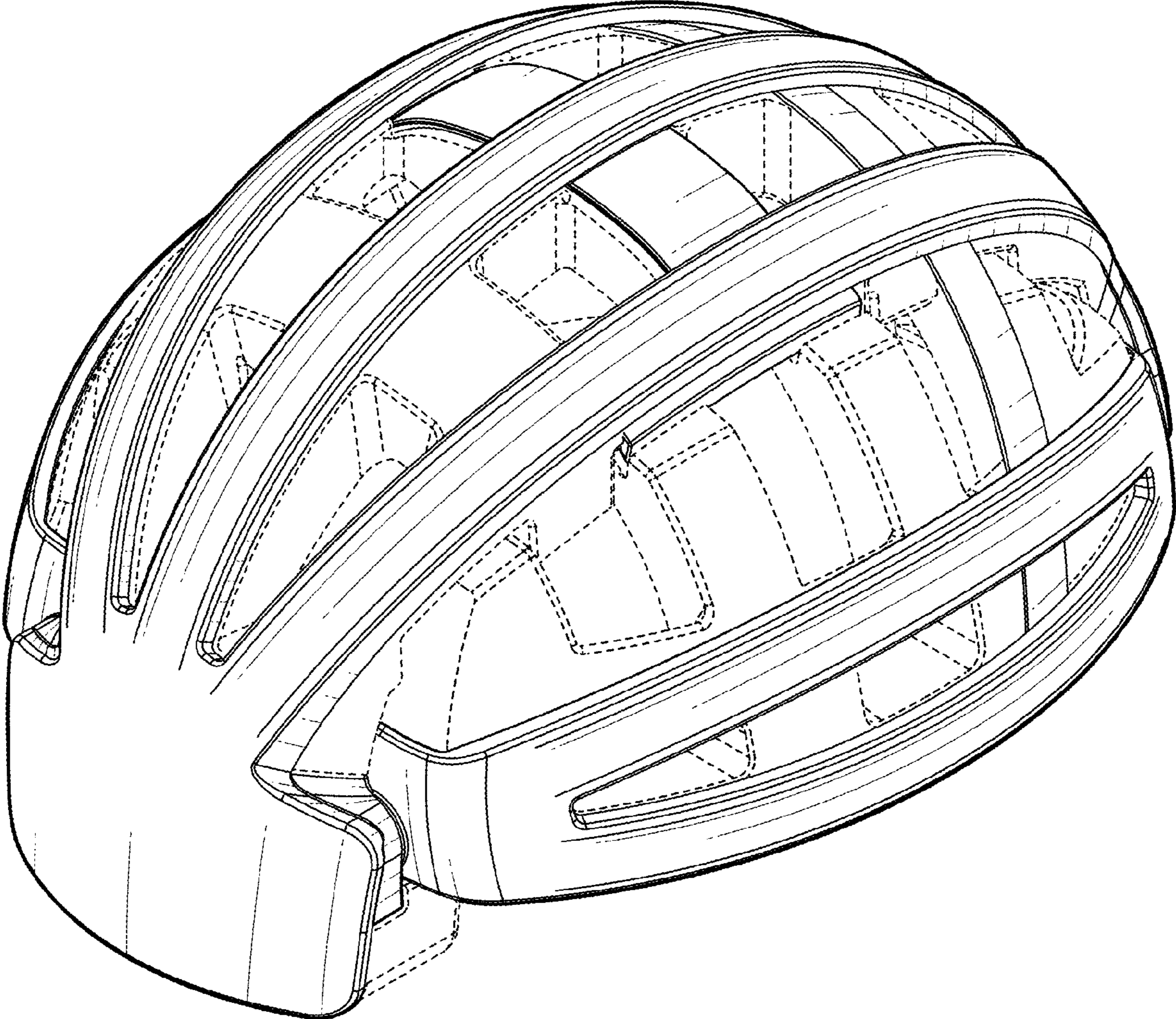

FIG. 8

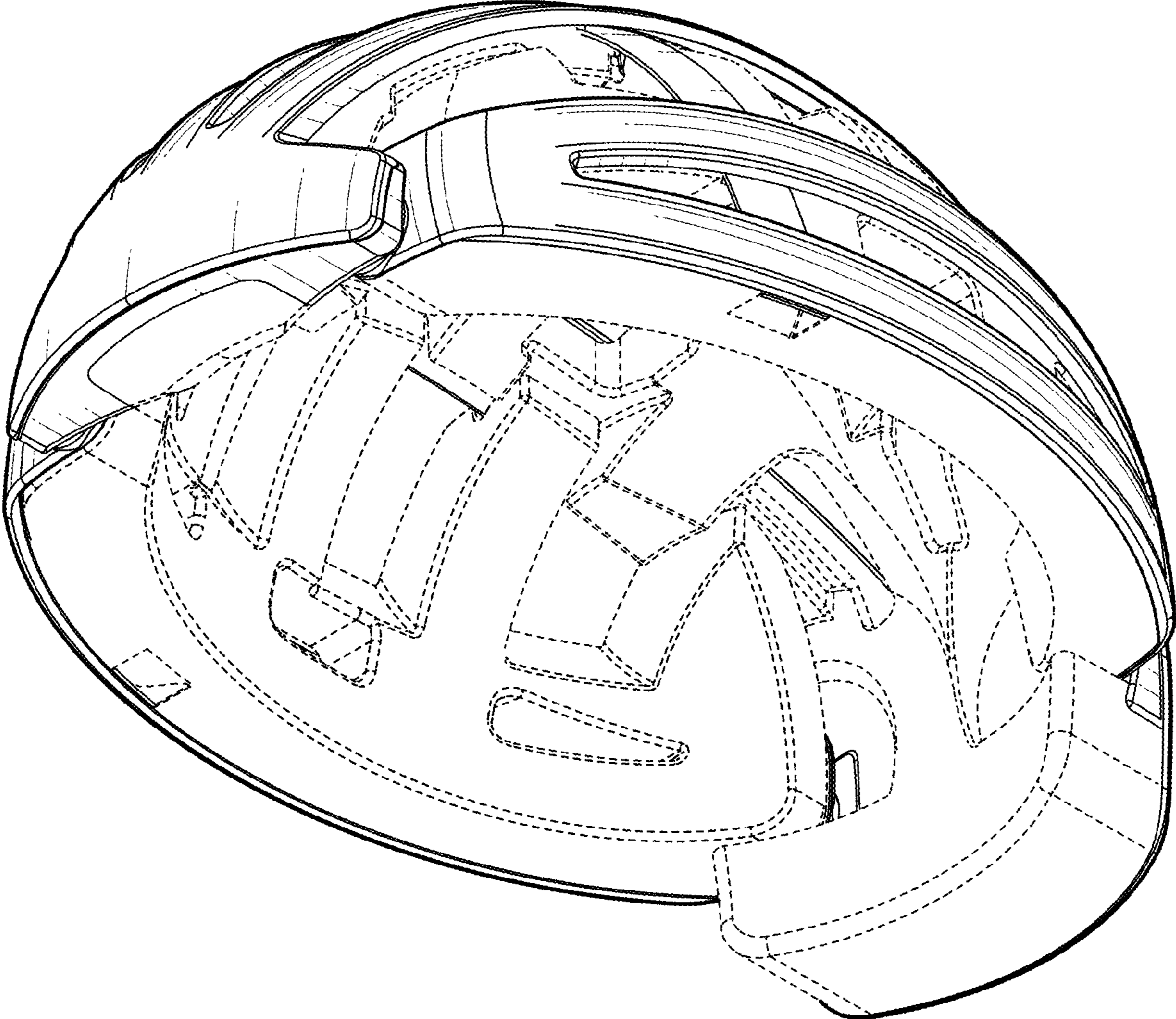

FIG. 9

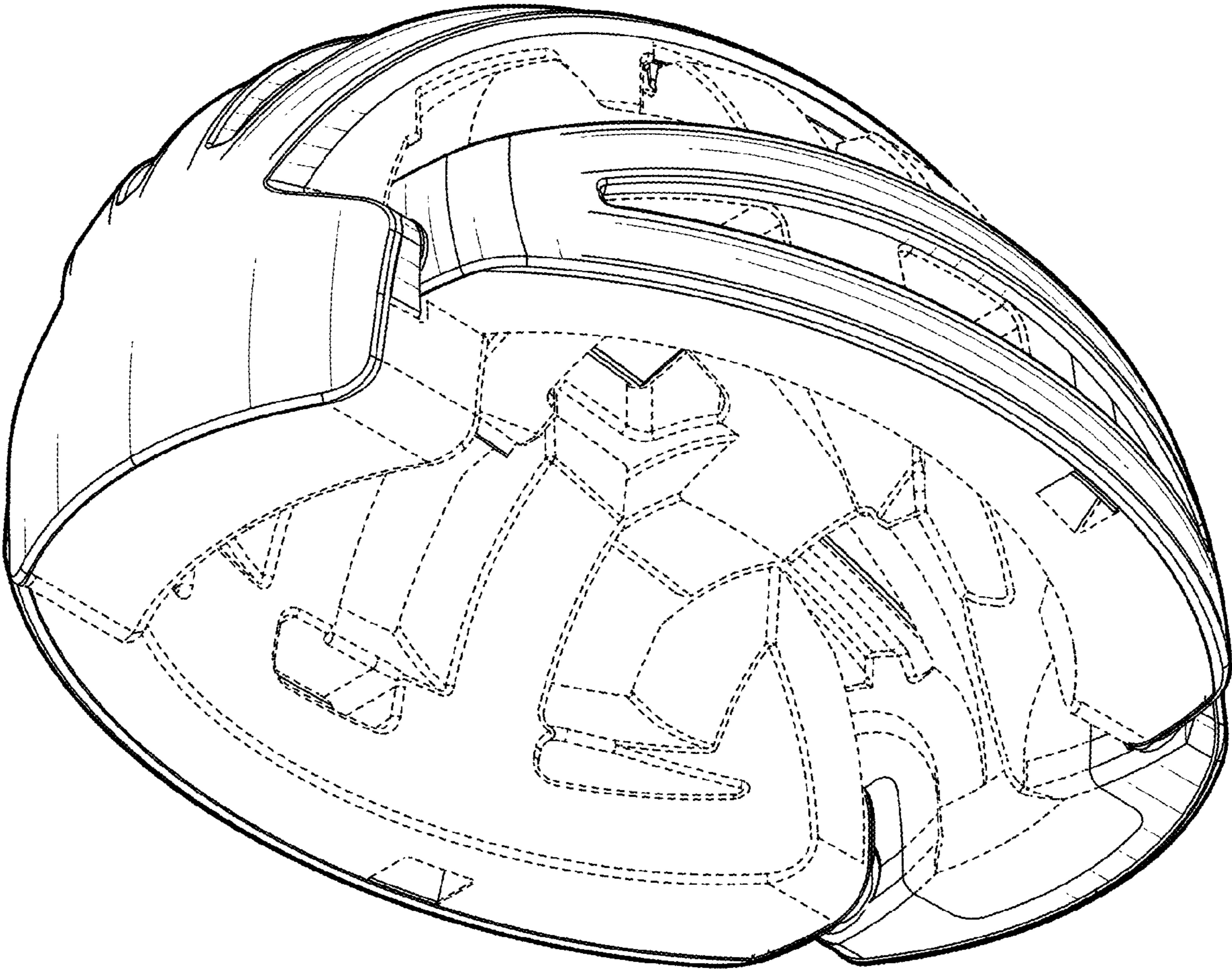

FIG. 10

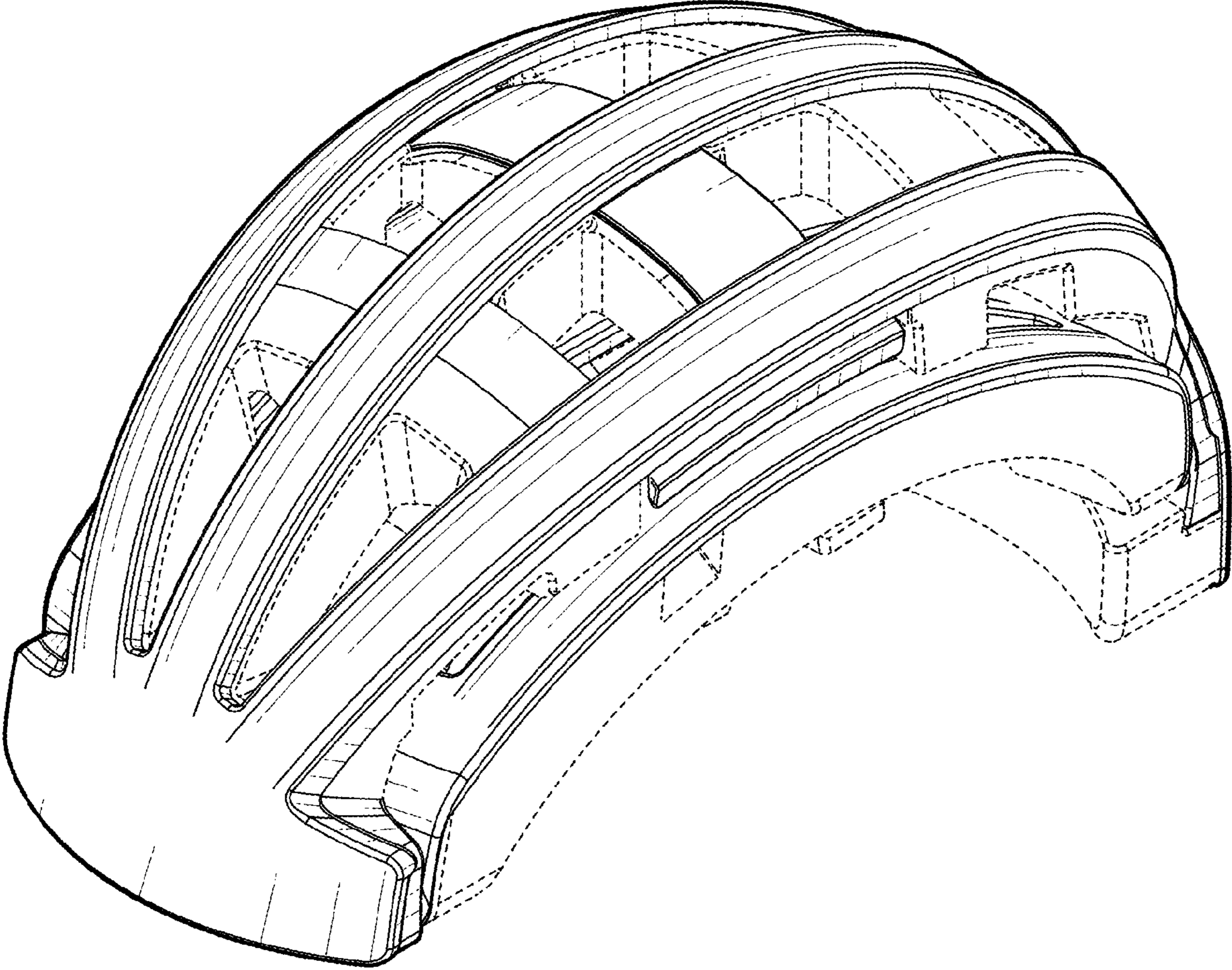

FIG. 11

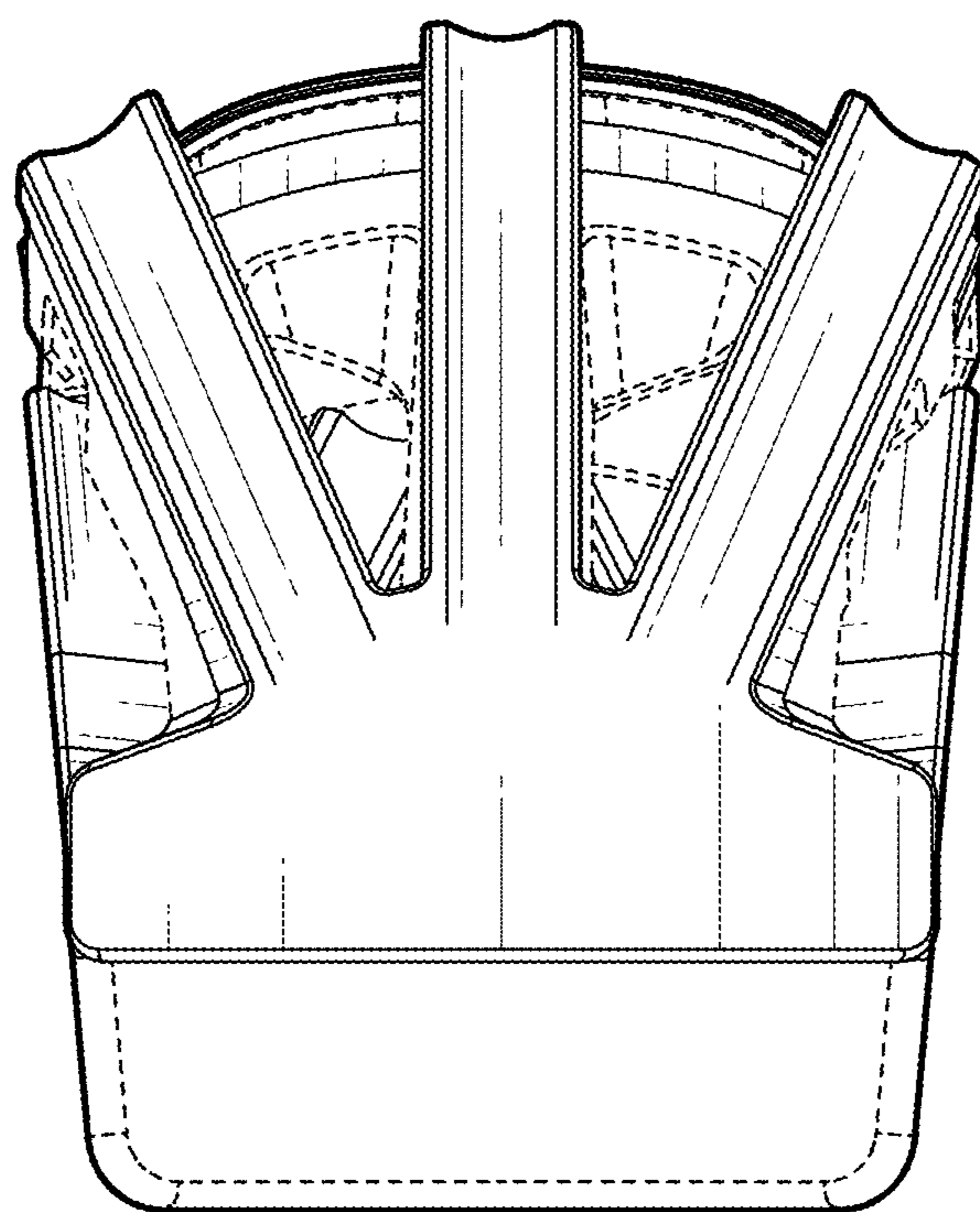

FIG. 12

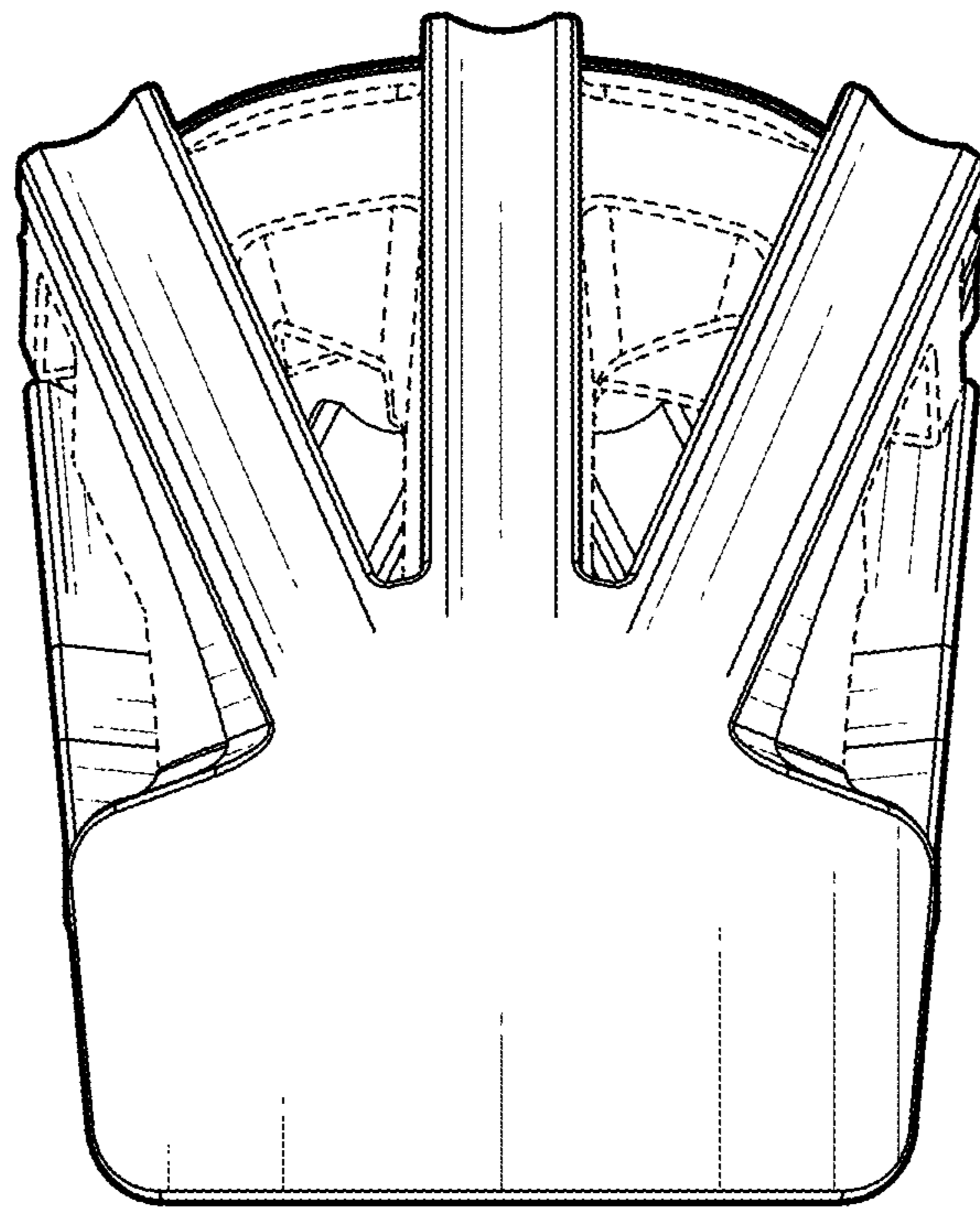

FIG. 13

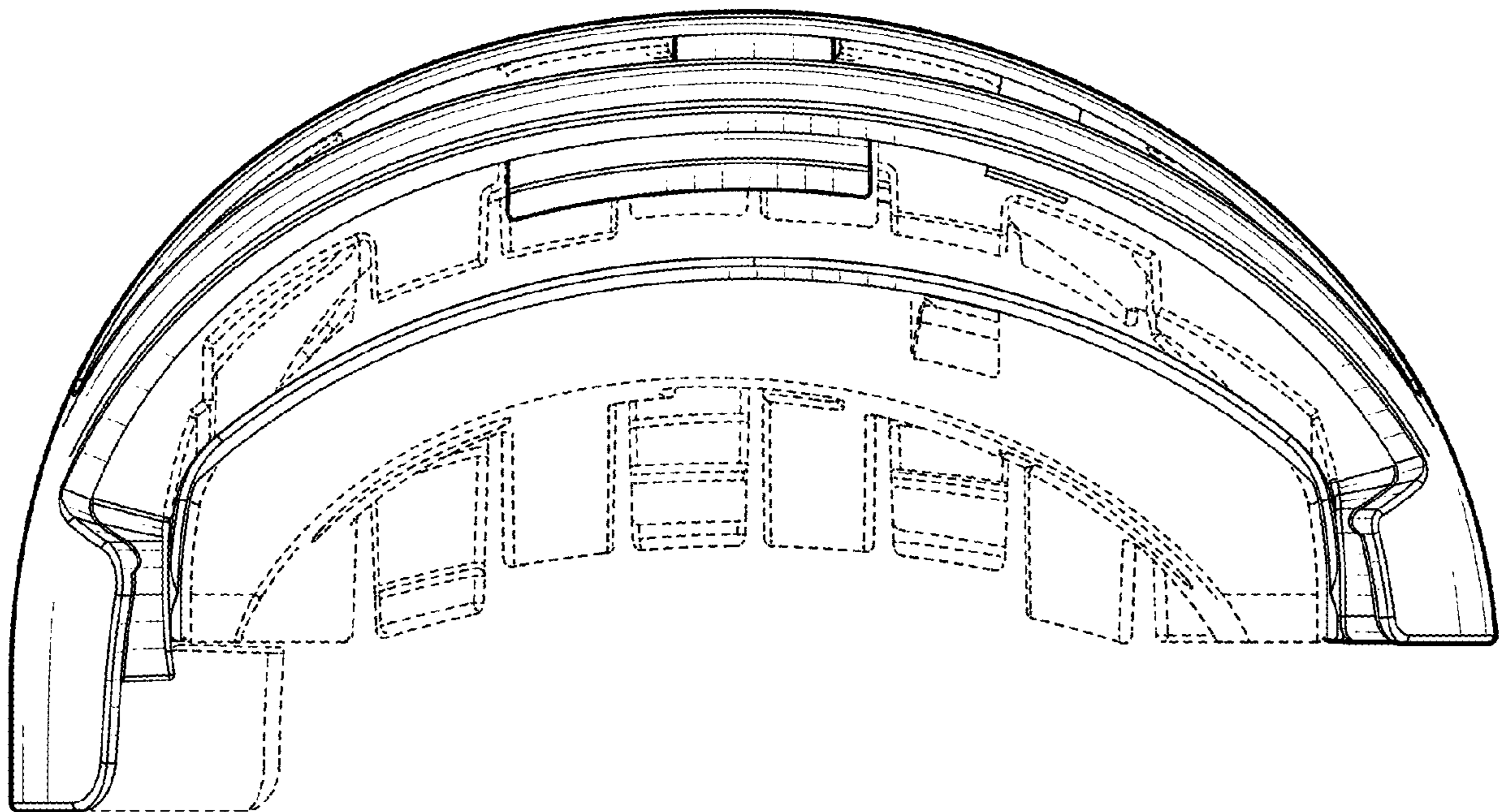

FIG. 14



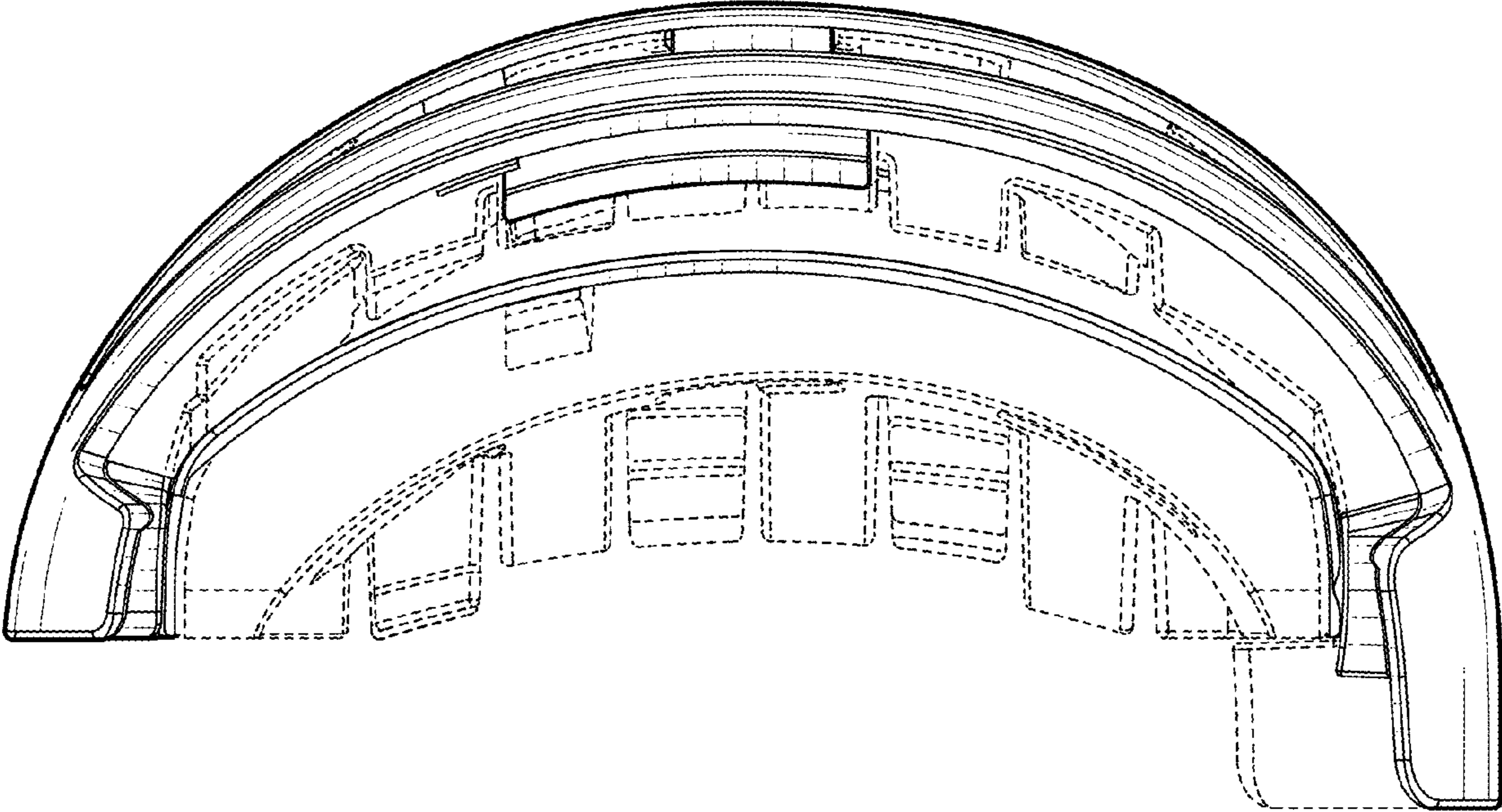

FIG. 15

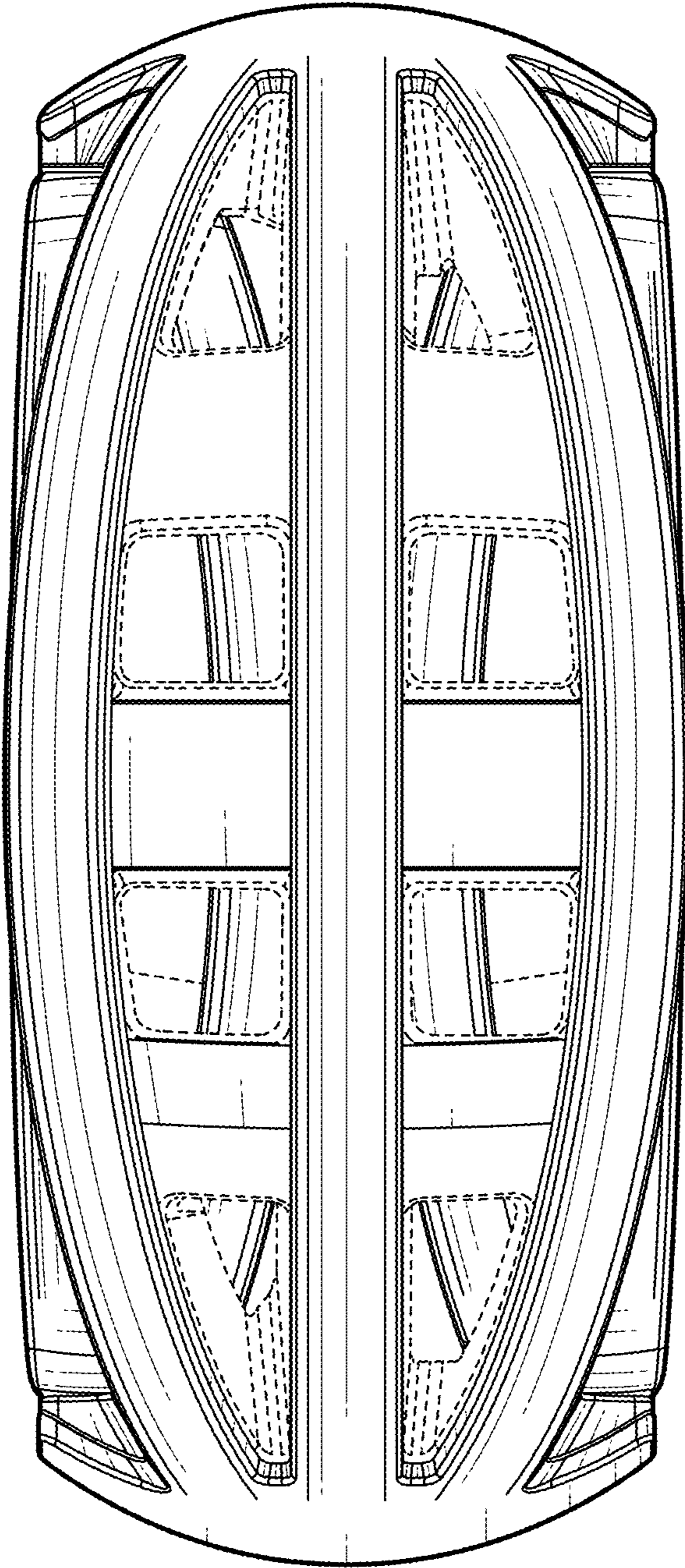

FIG. 16

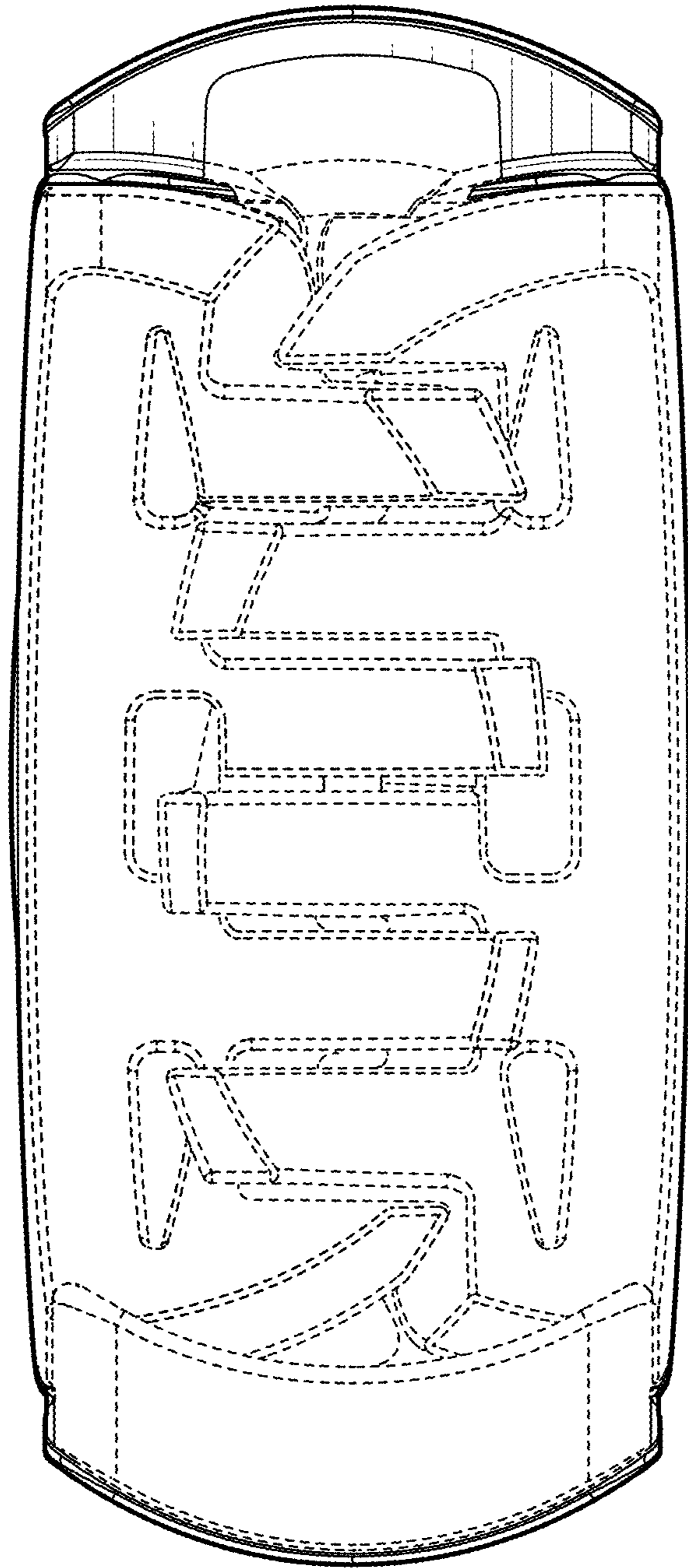

FIG. 17

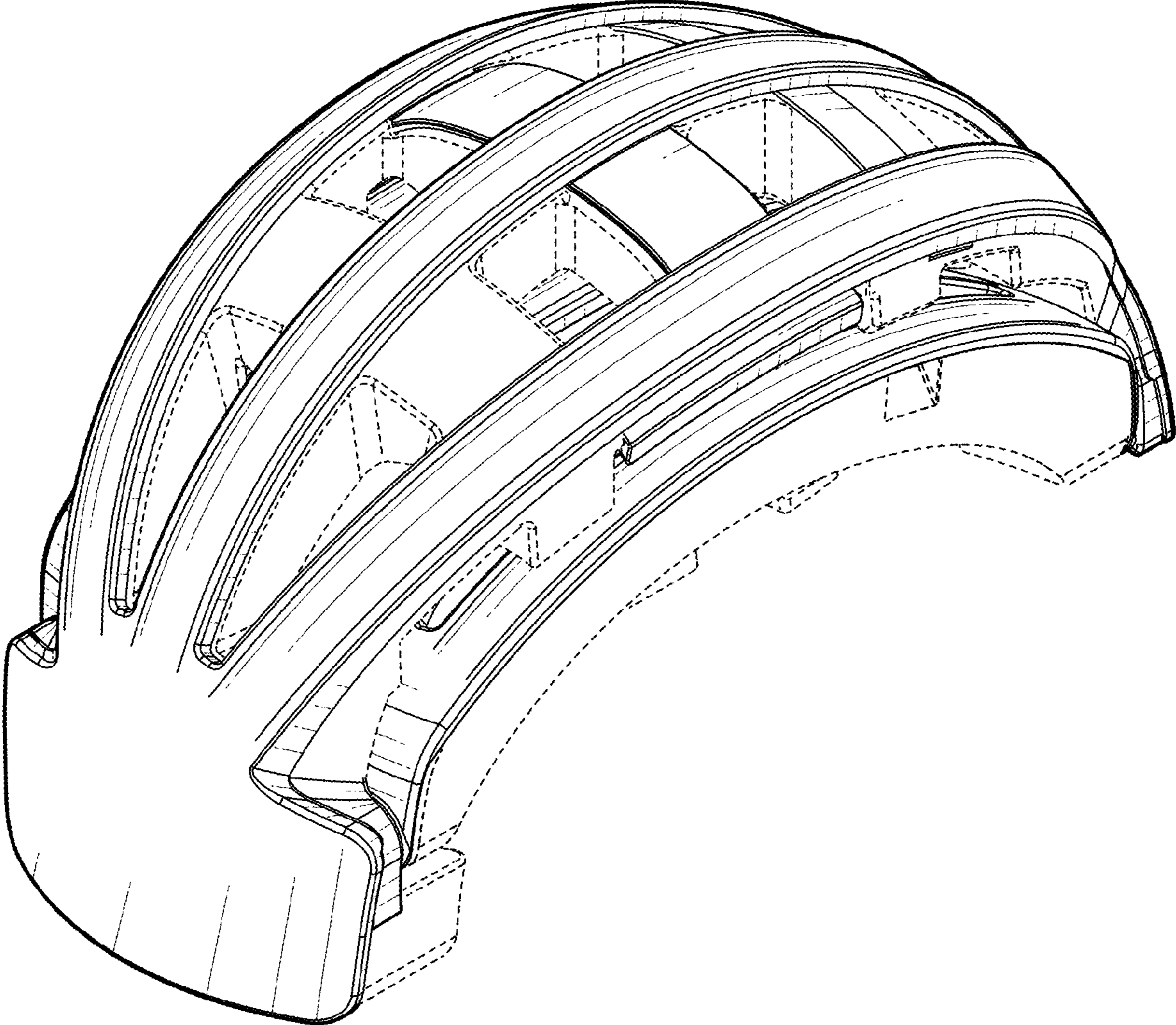

FIG. 18

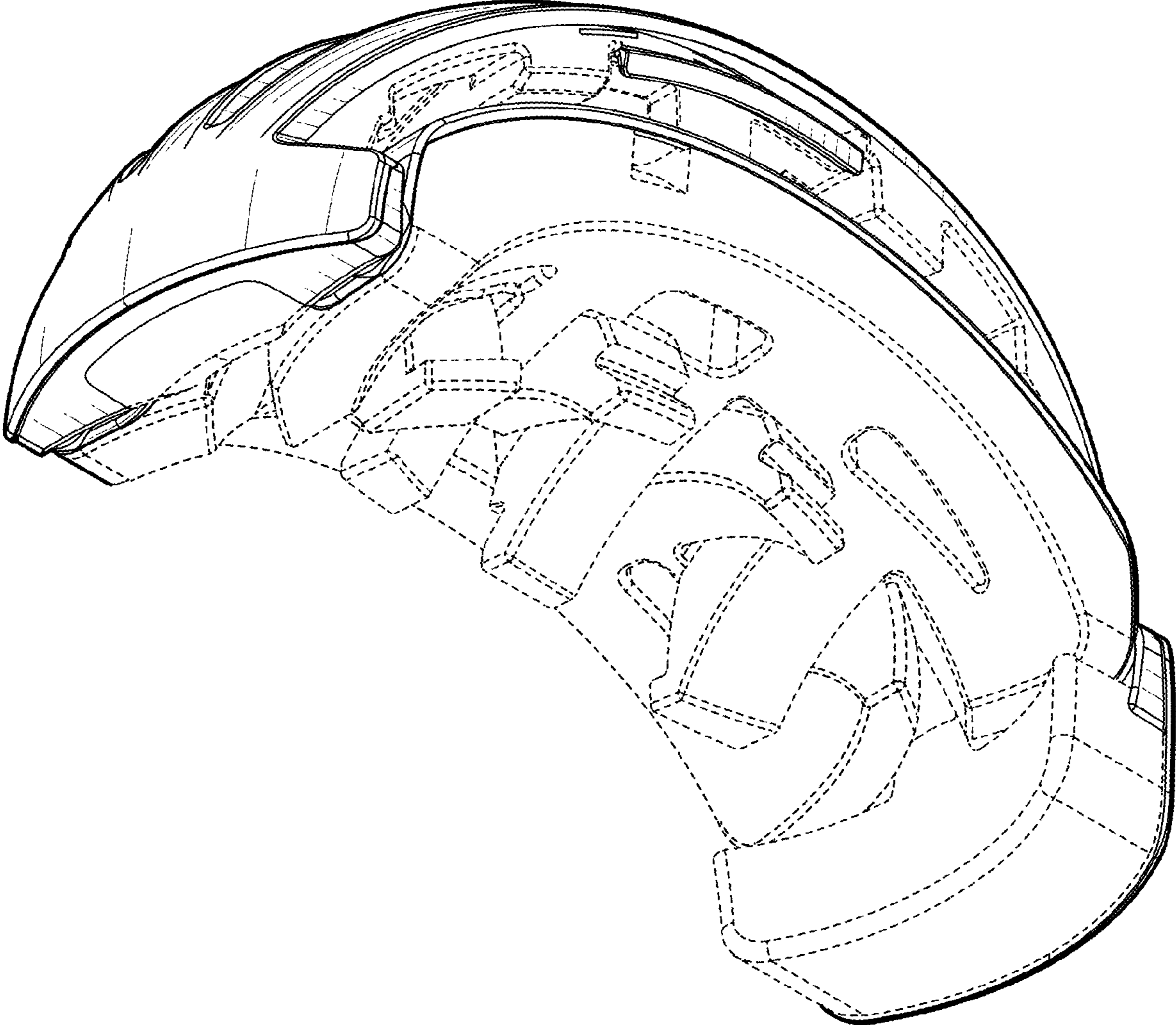

FIG. 19

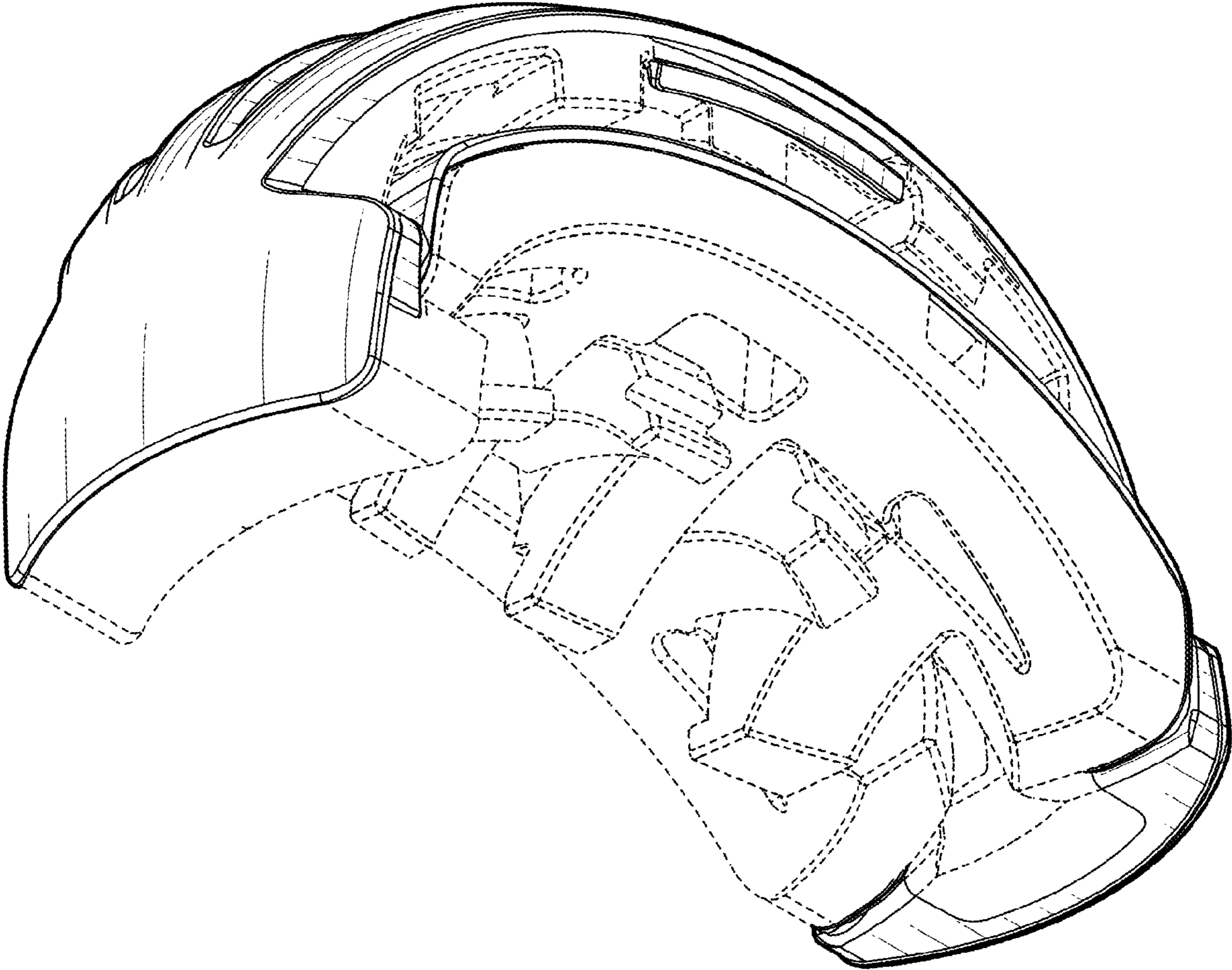

FIG. 20