



US00D873455S

(12) **United States Design Patent** (10) **Patent No.:** **US D873,455 S**
Han et al. (45) **Date of Patent:** **** Jan. 21, 2020**

(54) **REAR COMBINATION LAMP FOR AN AUTOMOBILE**

(71) Applicants: **HYUNDAI MOTOR COMPANY**, Seoul (KR); **KIA MOTORS CORPORATION**, Seoul (KR)

(72) Inventors: **Jae Do Han**, Yongin-si (KR); **Keon Soo Jin**, Ulsan (KR); **Min Jae Kwon**, Seoul (KR); **Sung Uk Choi**, Suwon-si (KR); **Byung Ho Kong**, Seoul (KR)

(73) Assignees: **Hyundai Motor Company**, Seoul (KR); **Kia Motors Corporation**, Seoul (KR)

(**) Term: **15 Years**

(21) Appl. No.: **35/506,228**

(22) Filed: **Jun. 18, 2018**

(80) **Hague Agreement Data**
Int. Filing Date: **Jun. 18, 2018**
Int. Reg. No.: **DM/101785**
Int. Reg. Date: **Jun. 18, 2018**
Int. Reg. Pub. Date: **Dec. 21, 2018**

(30) **Foreign Application Priority Data**
Apr. 13, 2018 (KR) 30-2018-0017474
(51) **LOC (12) Cl.** **26-06**
(52) **U.S. Cl.**
USPC **D26/28**
(58) **Field of Classification Search**
USPC D12/196; D26/28, 35, 36; D21/433
CPC .. F21S 41/00; F21S 41/20; F21S 41/30; F21S 43/14; F21S 43/15; F21S 43/20
See application file for complete search history.

(56) **References Cited**
U.S. PATENT DOCUMENTS
D657,482 S * 4/2012 Kong D26/28
D714,986 S * 10/2014 Moon D26/28
D721,195 S * 1/2015 Lim D26/28
D721,839 S * 1/2015 Ha D26/28
D727,547 S * 4/2015 Ha D26/28
D736,436 S * 8/2015 Park D26/28
D755,423 S * 5/2016 Kong D26/28
D781,471 S * 3/2017 Han D26/28
D795,473 S * 8/2017 Fujiwara D26/28
D834,227 S * 11/2018 Lee D26/28
D834,229 S * 11/2018 Lee D26/28

* cited by examiner

Primary Examiner — Robert M. Spear
(74) *Attorney, Agent, or Firm* — Mintz Levin Cohn Ferris Glovsky and Popeo, P.C.; Peter F. Corless; Carolina E. Säve

(57) **CLAIM**

The ornamental design for a rear combination lamp for an automobile, as shown and described.

DESCRIPTION

1. Rear combination lamp for an automobile
1.1 : Perspective
1.2 : Front
1.3 : Back
1.4 : Left
1.5 : Right
1.6 : Top
1.7 : Bottom

1 Claim, 7 Drawing Sheets

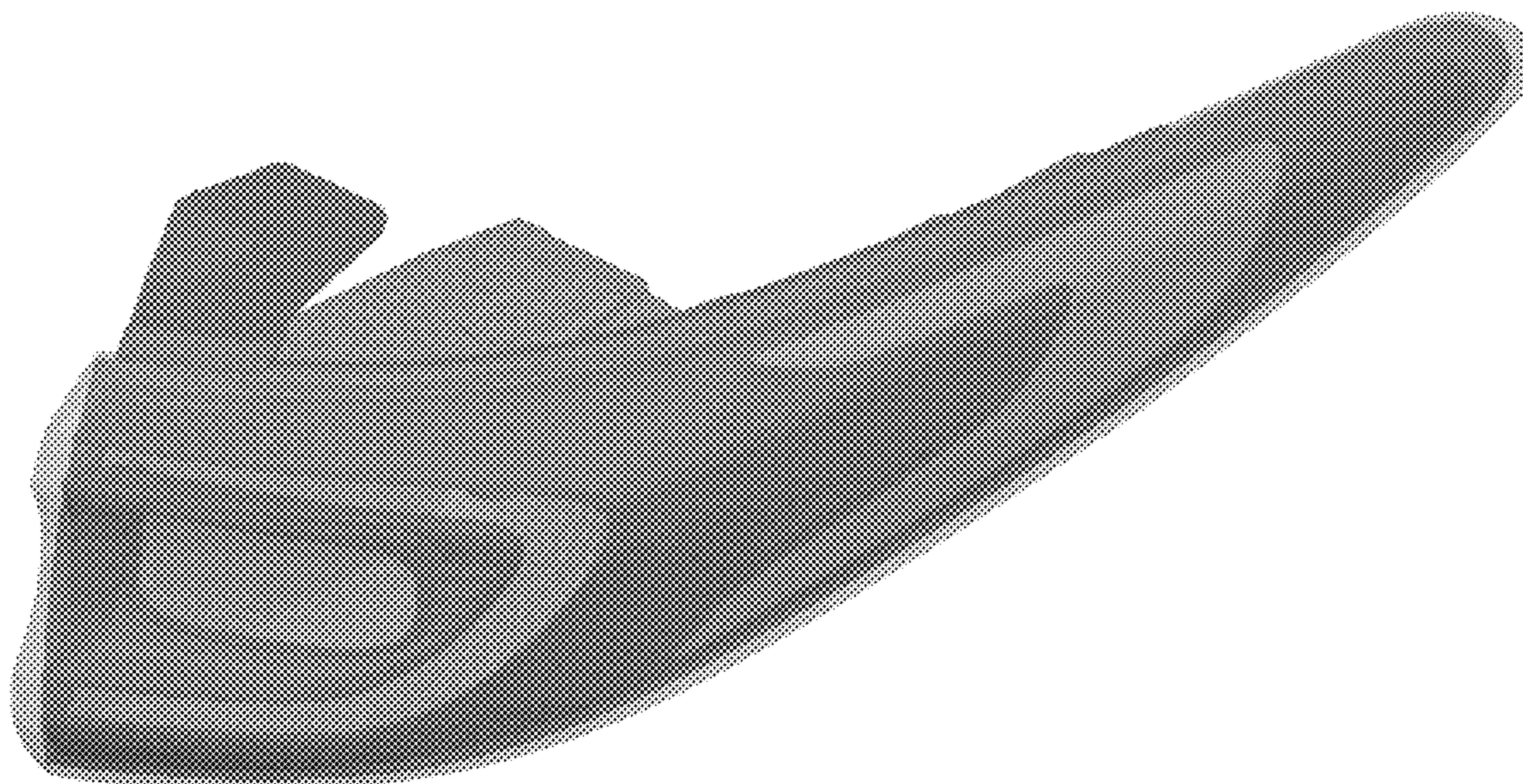

1.1

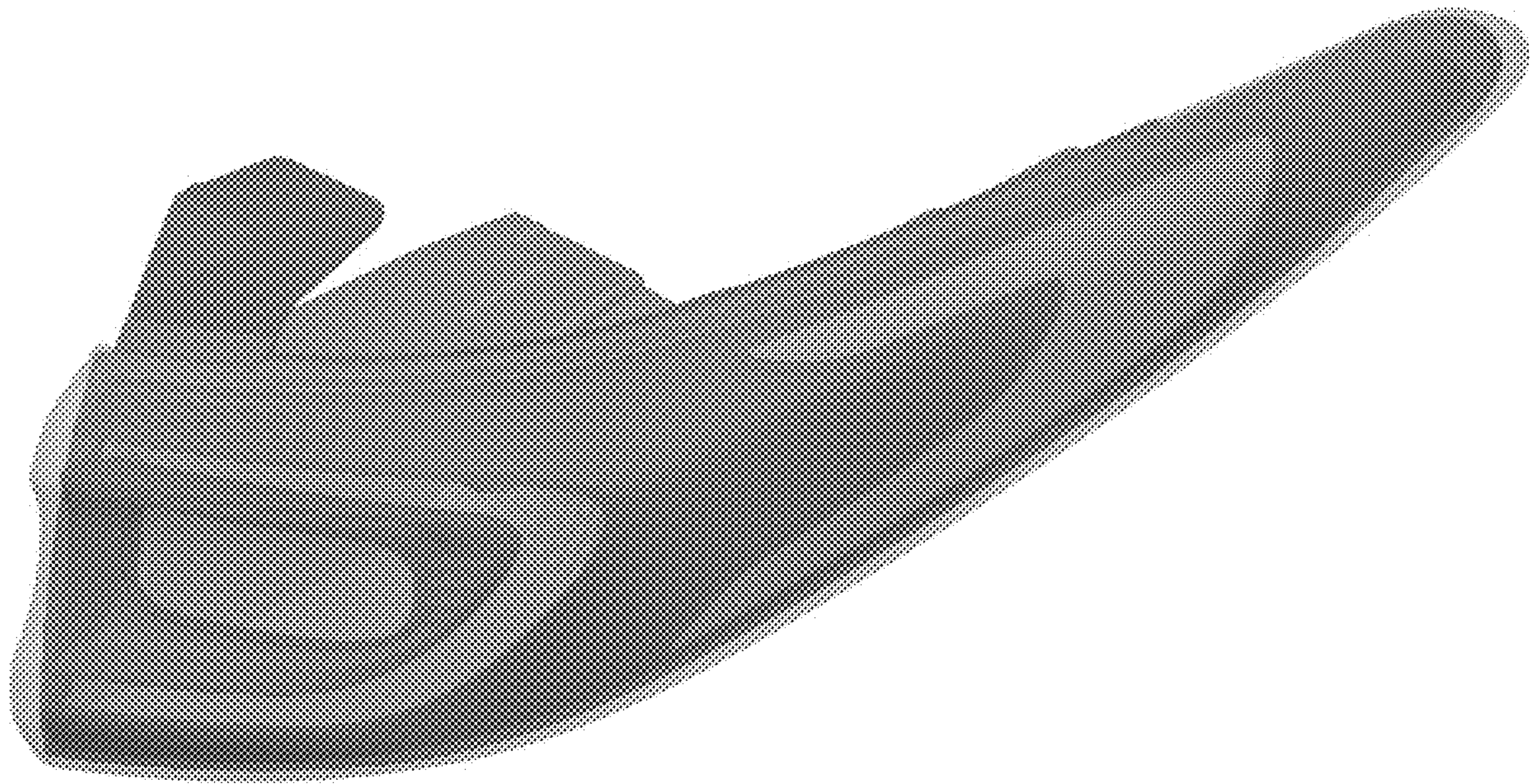

1.2

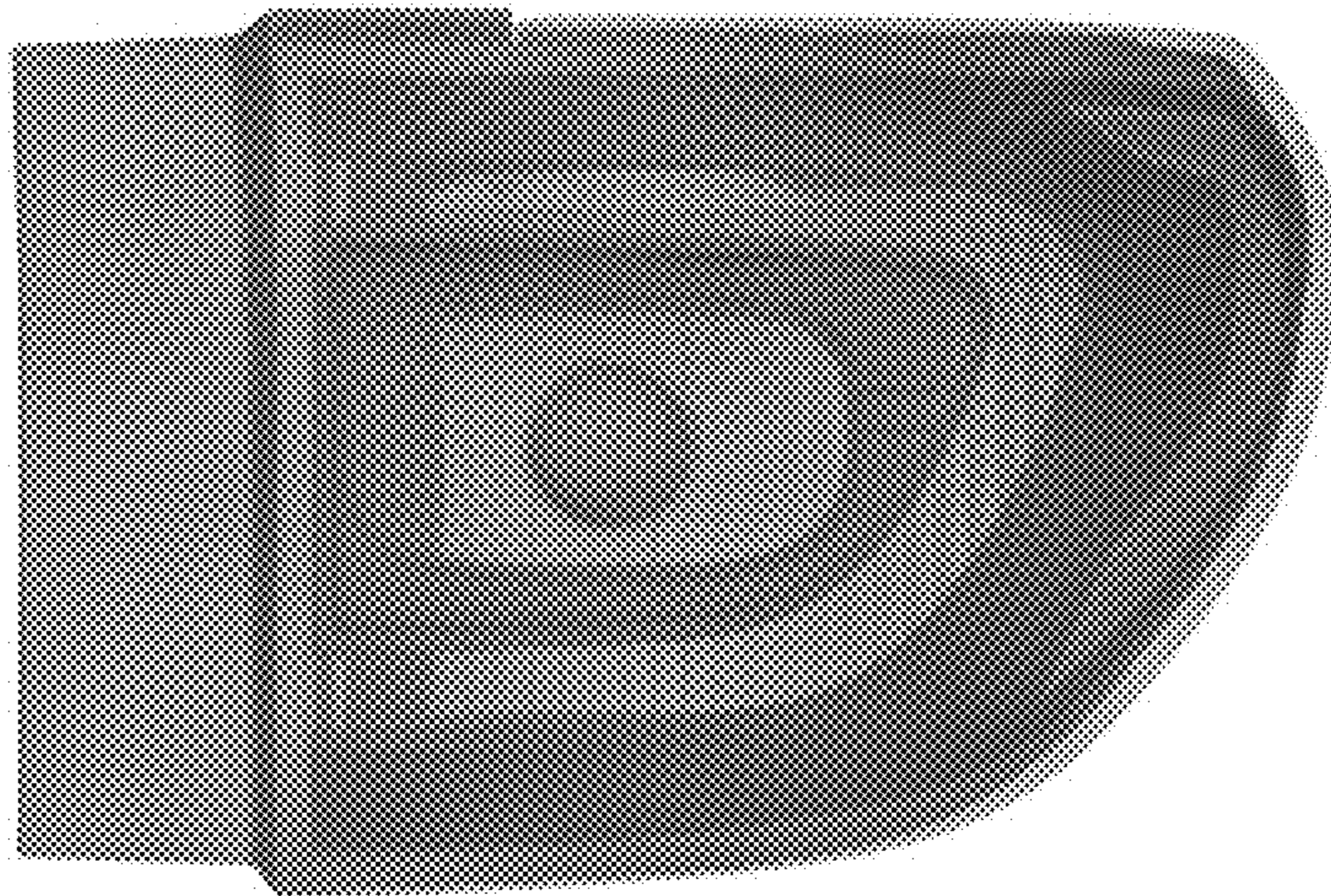

1.3

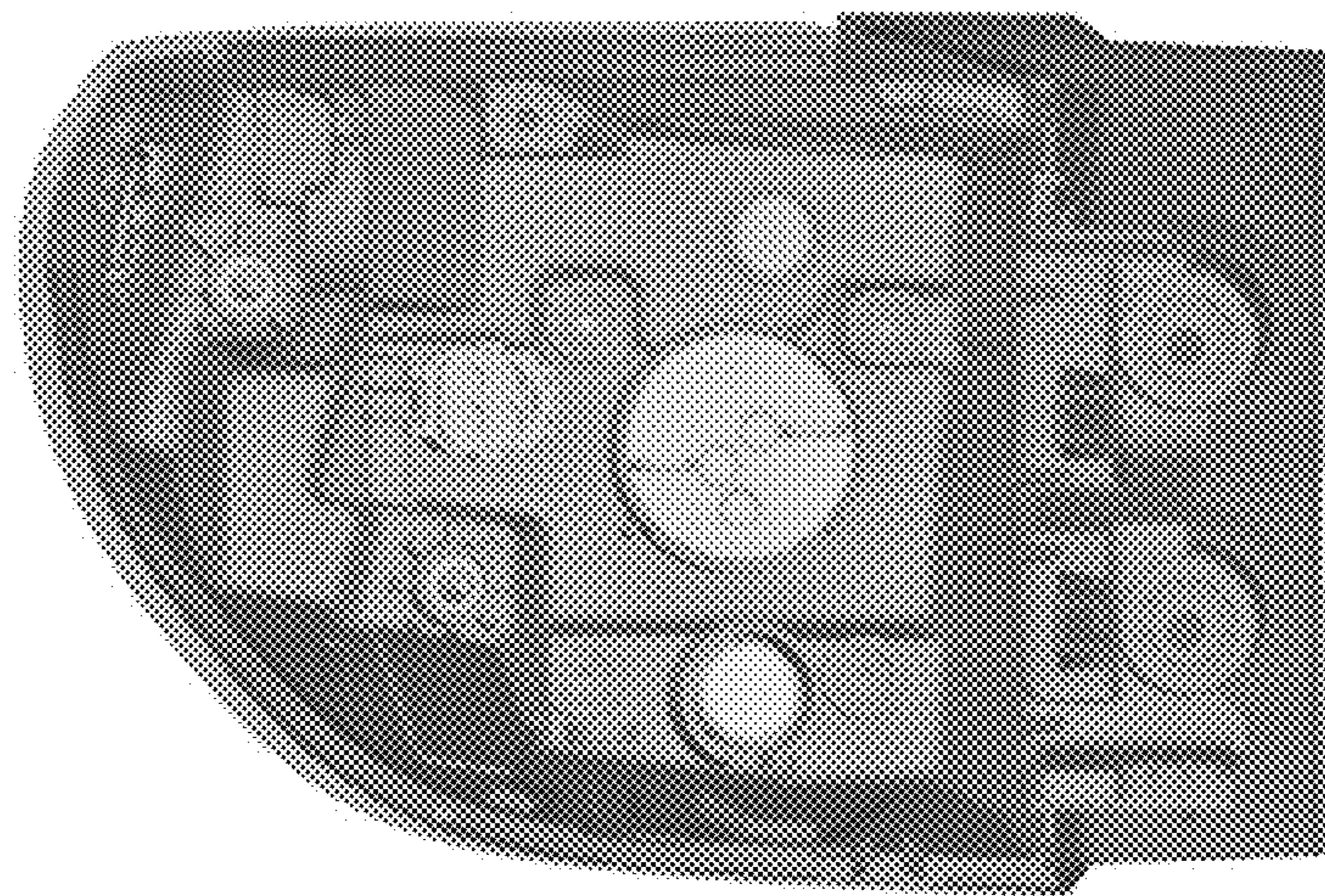

1.4

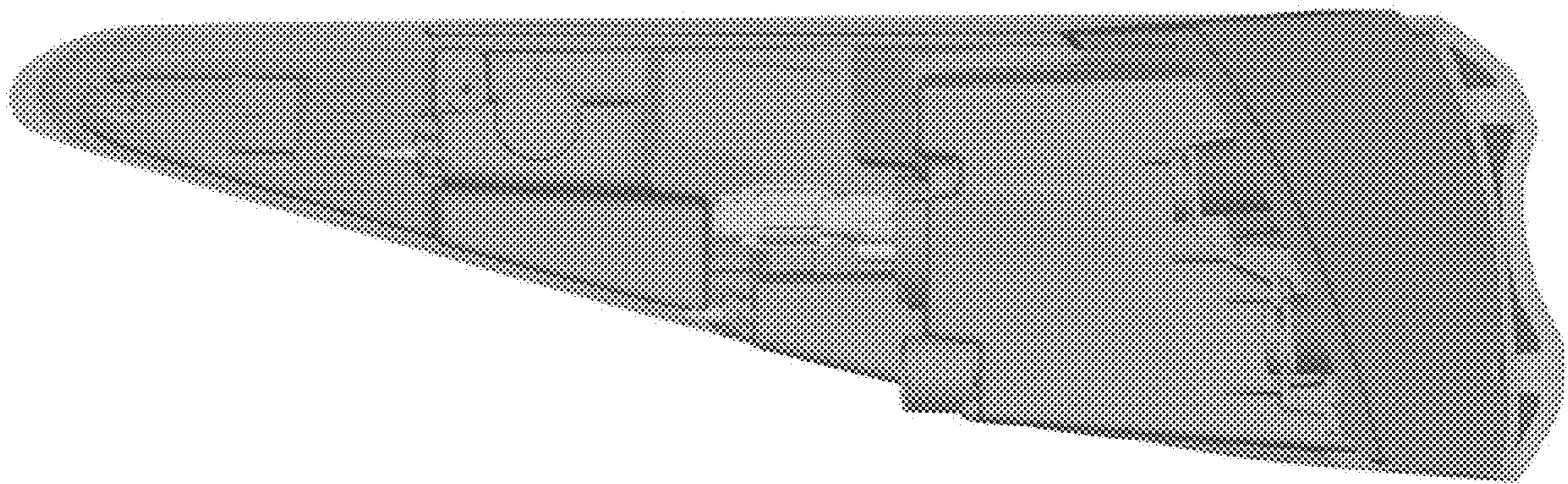

1.5

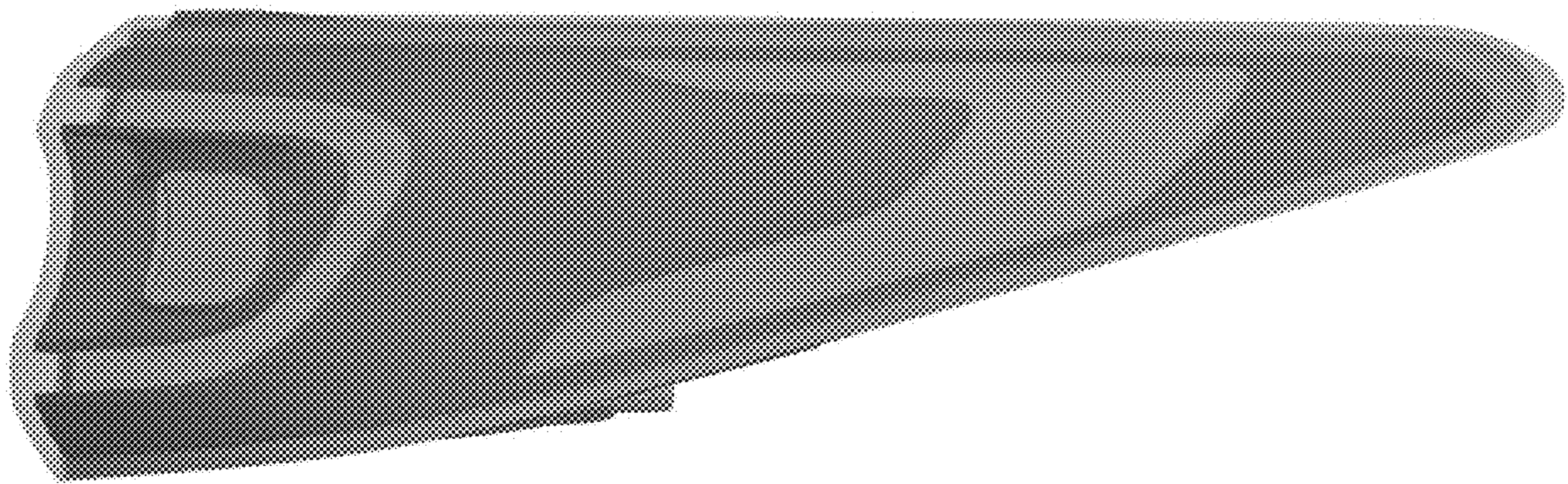

1.6

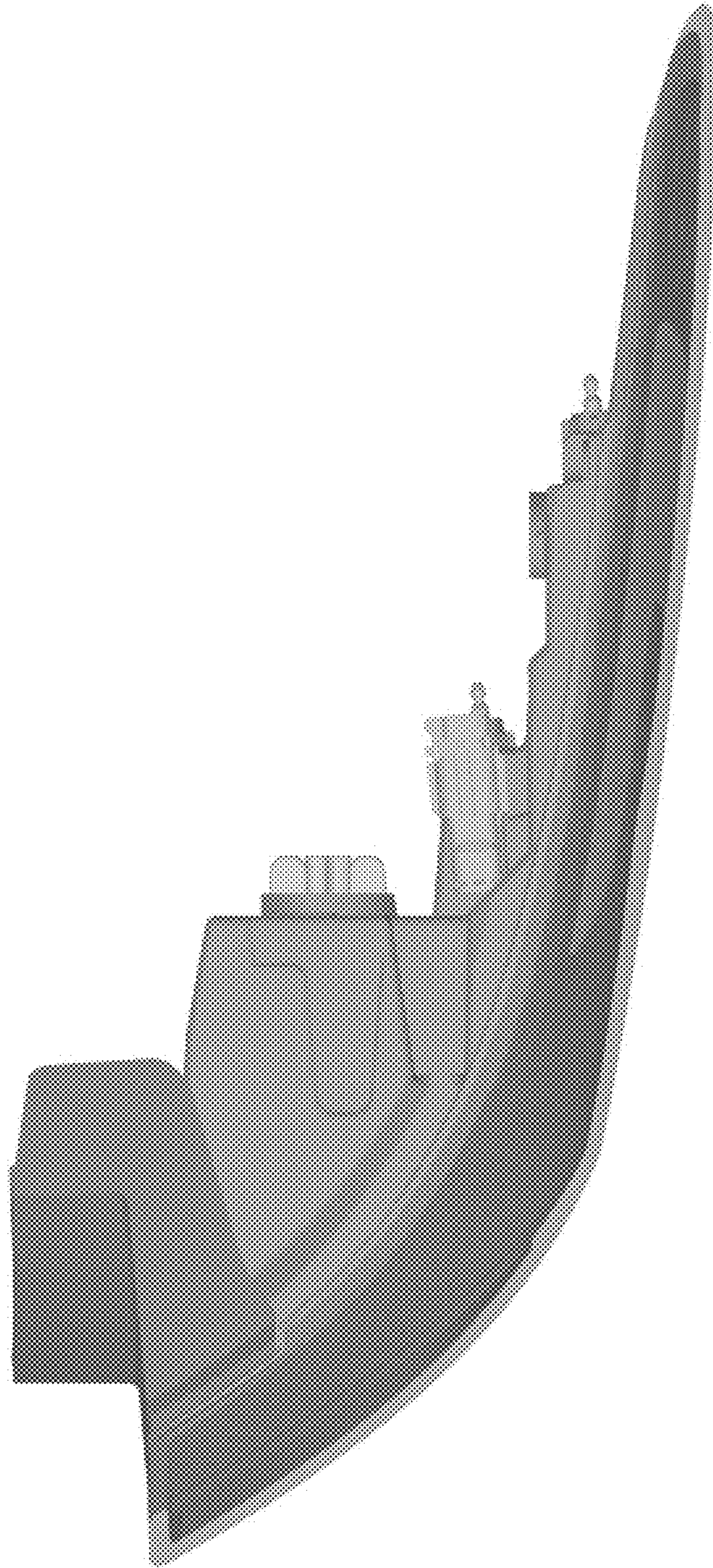

1.7

