



US00D873420S

(12) **United States Design Patent**
Hinshon

(10) **Patent No.:** **US D873,420 S**
(45) **Date of Patent:** **** Jan. 21, 2020**

- (54) **ANKLE JOINT**
- (71) Applicant: **Orthotic Care Services, LLP**,
Minneapolis, MN (US)
- (72) Inventor: **Patrick Scott Hinshon**, Maplewood,
MN (US)
- (73) Assignee: **Orthotic Car Services, LLP**,
Minneapolis, MN (US)
- (**) Term: **15 Years**
- (21) Appl. No.: **29/620,390**
- (22) Filed: **Aug. 9, 2017**
- (51) **LOC (12) Cl.** **24-01**
- (52) **U.S. Cl.**
USPC **D24/190**
- (58) **Field of Classification Search**
USPC D24/155, 190–192
CPC A61F 5/0111; A61F 5/0102; A61F 5/0127
See application file for complete search history.

- 7,500,957 B2 * 3/2009 Bledsoe A61F 5/0123
602/16
- 7,753,866 B2 * 7/2010 Jackovitch A61F 5/0127
128/846
- D726,925 S * 4/2015 Fraser D24/190
- D731,663 S * 6/2015 Jung D24/190
- D779,078 S * 2/2017 Drewitz D24/192
- 9,925,082 B2 * 3/2018 Chetlapalli A61F 5/0123
- 2011/0282255 A1 * 11/2011 Nace A61F 5/0123
602/16

* cited by examiner

Primary Examiner — Jennifer L Watkins

(74) *Attorney, Agent, or Firm* — Craig J. Lervick; Larkin Hoffman Daly & Lindgren, Ltd.

(57) **CLAIM**

I claim the ornamental design for an ankle joint, as shown and described.

DESCRIPTION

FIG. 1 is a perspective view of an ankle joint showing the design;
 FIG. 2 is a first side view of the device illustrated in FIG. 1;
 FIG. 3 is a second side view thereof;
 FIG. 4 is a first end view of the device shown in FIGS. 1-3;
 FIG. 5 is a second end view thereof;
 FIG. 6 is a top view of the device illustrated in FIG. 1; and,
 FIG. 7 is bottom view thereof.

The portions of the ankle joint shown in broken lines in the drawings form no part of the claim.

1 Claim, 3 Drawing Sheets

- (56) **References Cited**
U.S. PATENT DOCUMENTS
- 5,277,698 A * 1/1994 Taylor A61F 5/0123
602/16
- 5,356,370 A * 10/1994 Fleming A61F 5/0123
403/158
- D431,654 S * 10/2000 Cruz D24/190
- D448,484 S * 9/2001 Bradshaw D24/155
- D489,135 S * 4/2004 Slautterback A61F 5/0127
D24/192
- D529,180 S * 9/2006 Ingimundarson D24/190

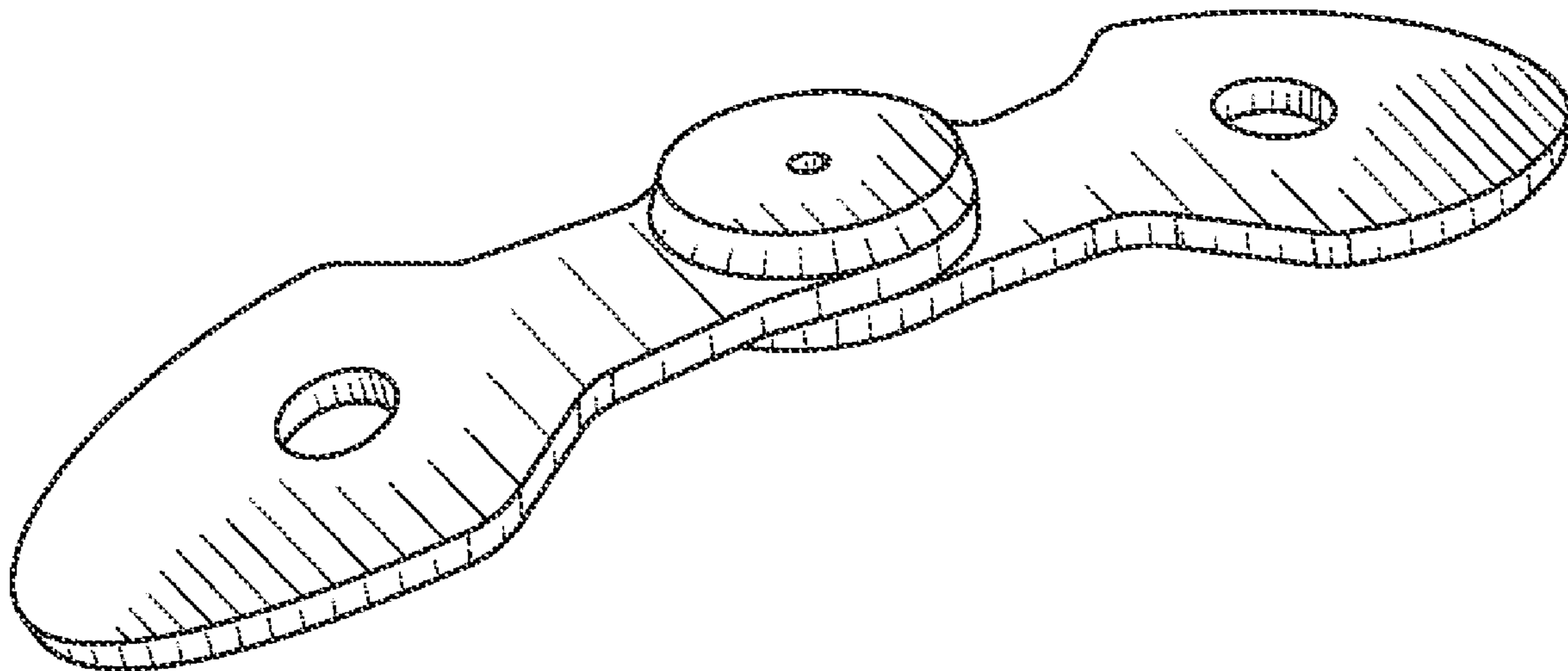

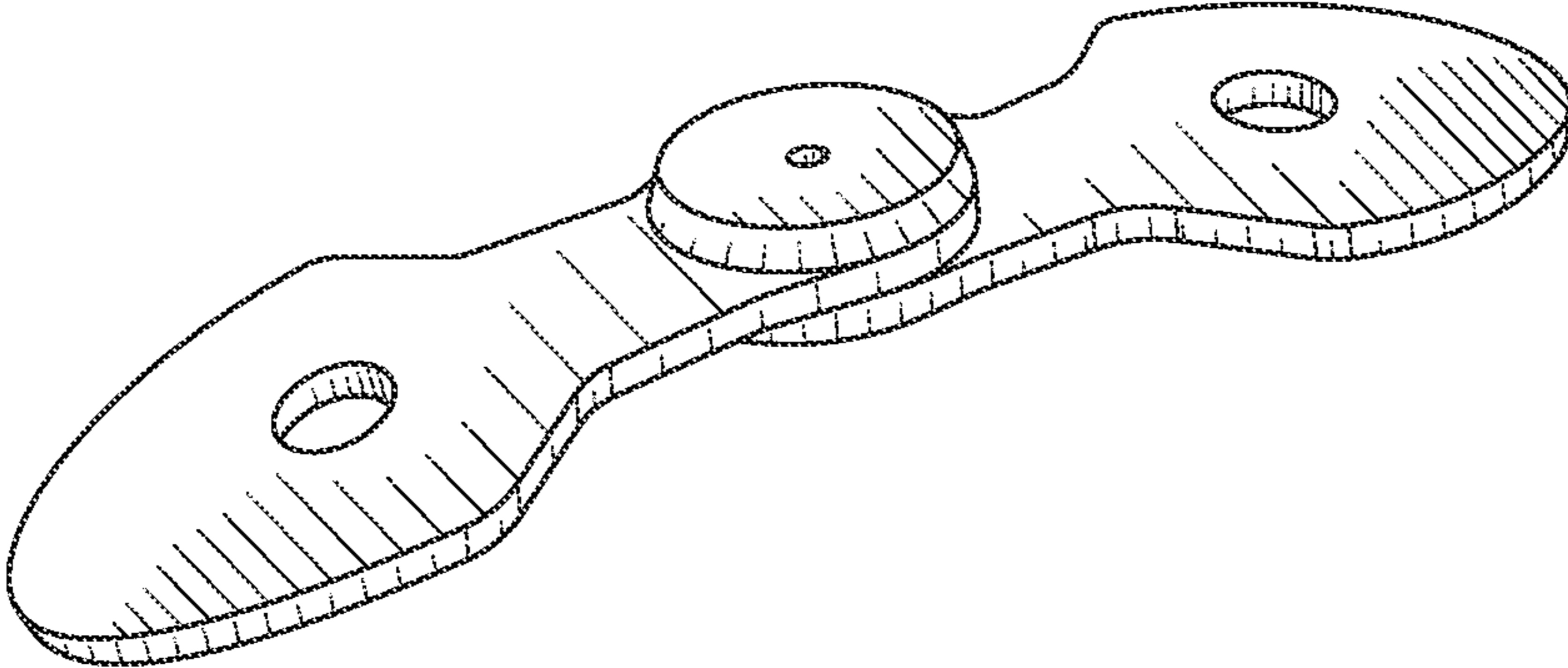

FIG. 1

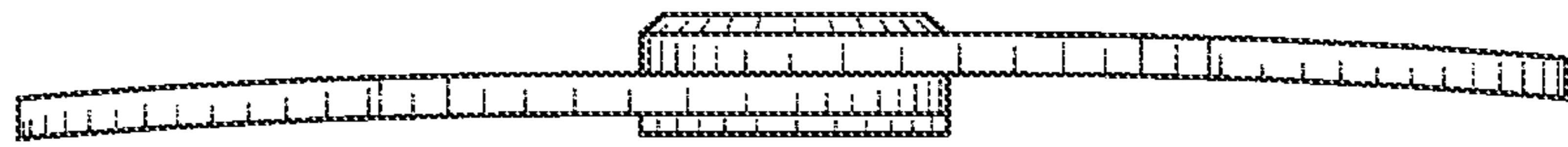

FIG. 2

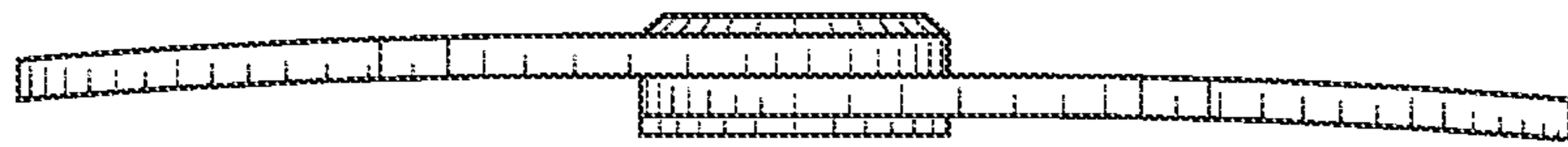

FIG. 3

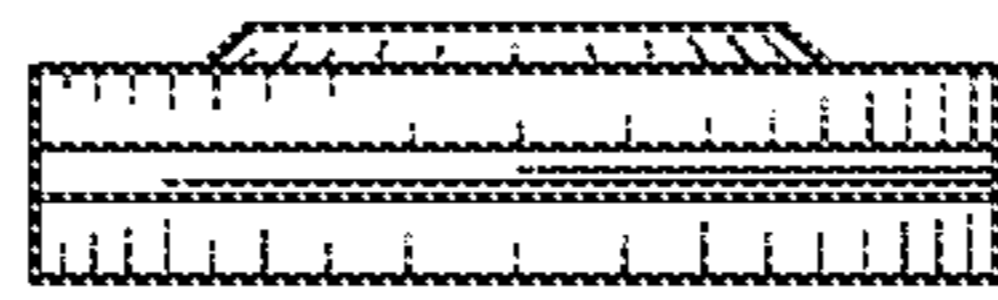

FIG. 4

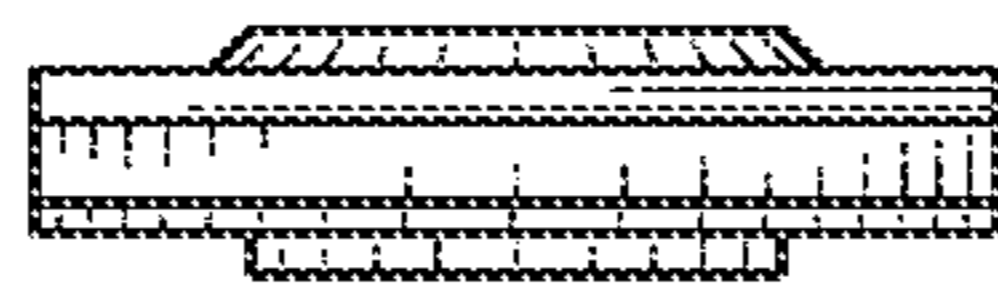

FIG. 5

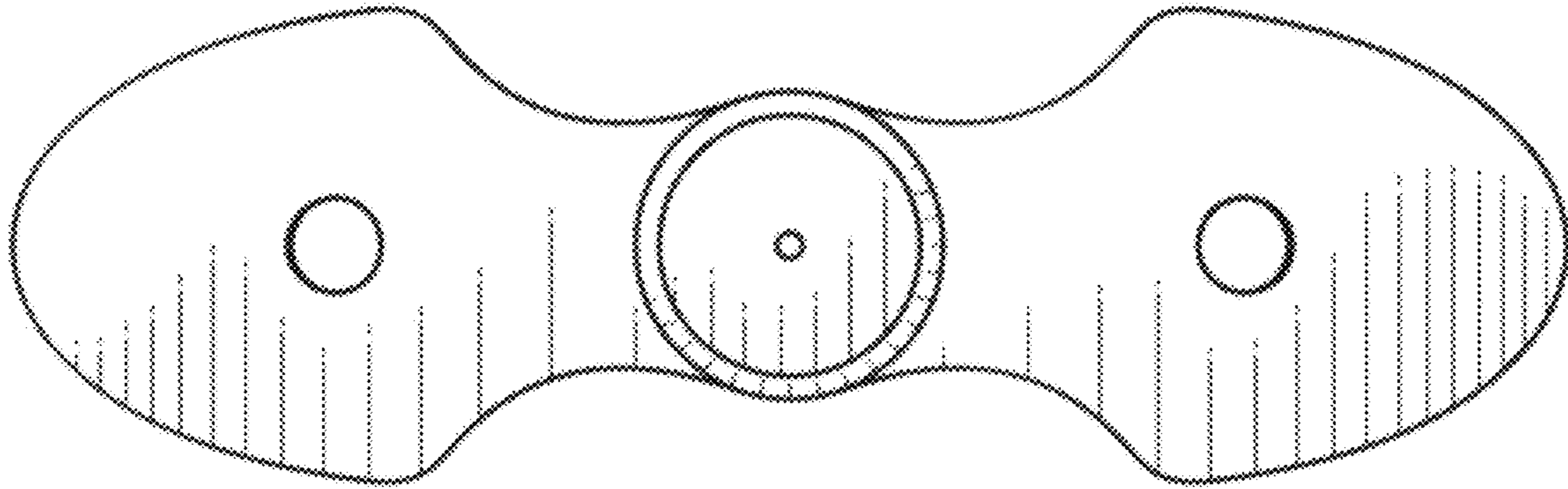

FIG. 6

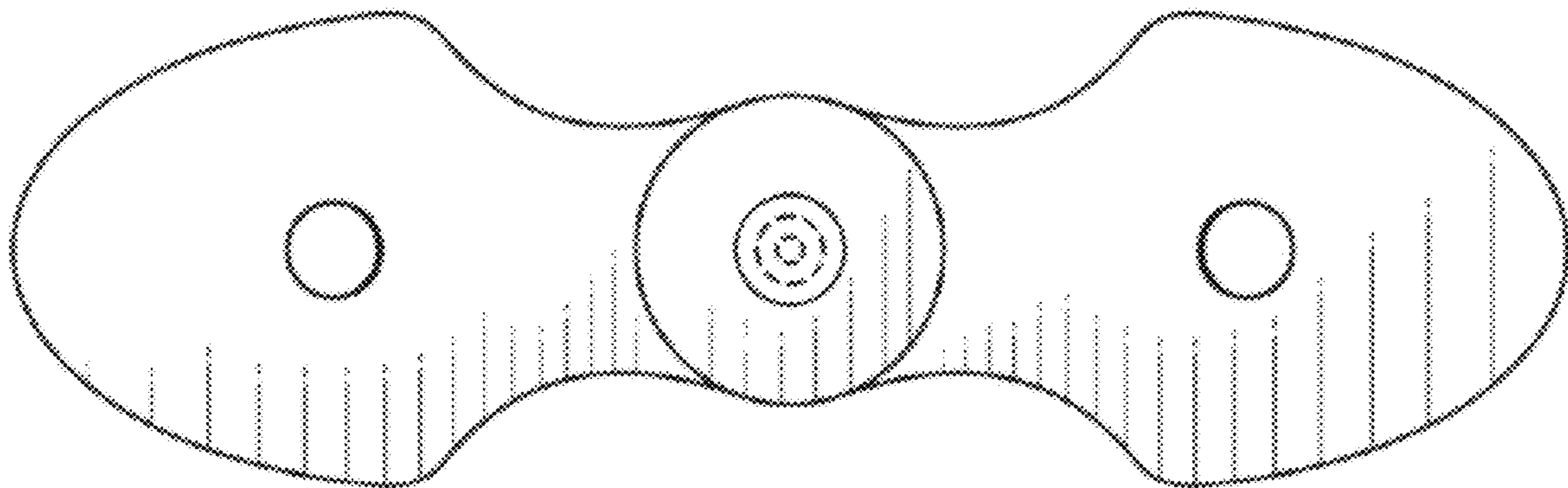

FIG. 7

UNITED STATES PATENT AND TRADEMARK OFFICE
CERTIFICATE OF CORRECTION

PATENT NO. : D873,420 S
APPLICATION NO. : 29/620390
DATED : January 21, 2020
INVENTOR(S) : Patrick Scott Hinshon et al.

Page 1 of 1

It is certified that error appears in the above-identified patent and that said Letters Patent is hereby corrected as shown below:

On the Title Page

Item (73) Assignee, should read:

--(73) Assignee: Orthotic Care Services, LLP, Minneapolis, MN (US)--

Signed and Sealed this
Twenty-seventh Day of August, 2024



Katherine Kelly Vidal
Director of the United States Patent and Trademark Office