



US00D873372S

(12) **United States Design Patent** (10) **Patent No.:** **US D873,372 S**
Shelton et al. (45) **Date of Patent:** **** Jan. 21, 2020**

(54) **VERTICAL GRIP ATTACHABLE TO A RAIL OF A FIREARM**

(71) Applicant: **RAILSCALES LLC**, Claremore, OK (US)

(72) Inventors: **Derek Hunter Shelton**, Claremore, OK (US); **Brent Taylor McGuire**, Depew, OK (US)

(73) Assignee: **RAILSCALES LLC**, Claremore, OK (US)

(**) Term: **15 Years**

(21) Appl. No.: **29/678,803**

(22) Filed: **Jan. 31, 2019**

Related U.S. Application Data

(62) Division of application No. 29/601,687, filed on Apr. 25, 2017.

(51) **LOC (12) Cl.** **22-01**

(52) **U.S. Cl.**
USPC **D22/108**

(58) **Field of Classification Search**
USPC D22/101, 107-111; D8/68
CPC F41C 23/10; F41C 23/14; F41C 23/16;
F41C 23/18

See application file for complete search history.

(56) **References Cited**

U.S. PATENT DOCUMENTS

D560,750 S *	1/2008	Potter	D22/108
D639,889 S *	6/2011	Troy, Jr.	D22/108
D769,400 S *	10/2016	Scheffer	D22/108
D774,620 S *	12/2016	Shelton	D22/108
D792,550 S *	7/2017	Smith	D22/111

(Continued)

OTHER PUBLICATIONS

Forend Grip, posted at Railscales, review posted Jun. 30, 2017. [Site visited Nov. 21, 2018] URL: <https://www.railscales.us/products/anchor#shopify-product-reviews> (Year: 2017).*

Primary Examiner — Kevin K Rudzinski

Assistant Examiner — Kathleen L Jones

(74) *Attorney, Agent, or Firm* — Eversheds Sutherland (US) LLP

(57) **CLAIM**

We claim the ornamental design for a vertical grip attachable to a rail of a firearm, as shown and described.

DESCRIPTION

FIG. 1 is a perspective view of a vertical grip attachable to a rail of a firearm according to a first embodiment of the disclosure;

FIG. 2 is a perspective view thereof;

FIG. 3 is a front view thereof;

FIG. 4 is a rear view thereof;

FIG. 5 is a side view thereof;

FIG. 6 is a side view thereof;

FIG. 7 is a bottom view thereof;

FIG. 8 is a top view thereof;

FIG. 9 is a perspective view of a vertical grip attachable to a rail of a firearm according to a second embodiment of the disclosure;

FIG. 10 is a perspective view thereof;

FIG. 11 is a front view thereof;

FIG. 12 is a rear view thereof;

FIG. 13 is a side view thereof;

FIG. 14 is a side view thereof;

FIG. 15 is a bottom view thereof; and,

FIG. 16 is a top view thereof.

The surfaces outside the scalloped solid line perimeter of the front and back grip features do not form part of the claimed design; the broken lines show portions of the article that form no part of the claimed design.

1 Claim, 16 Drawing Sheets

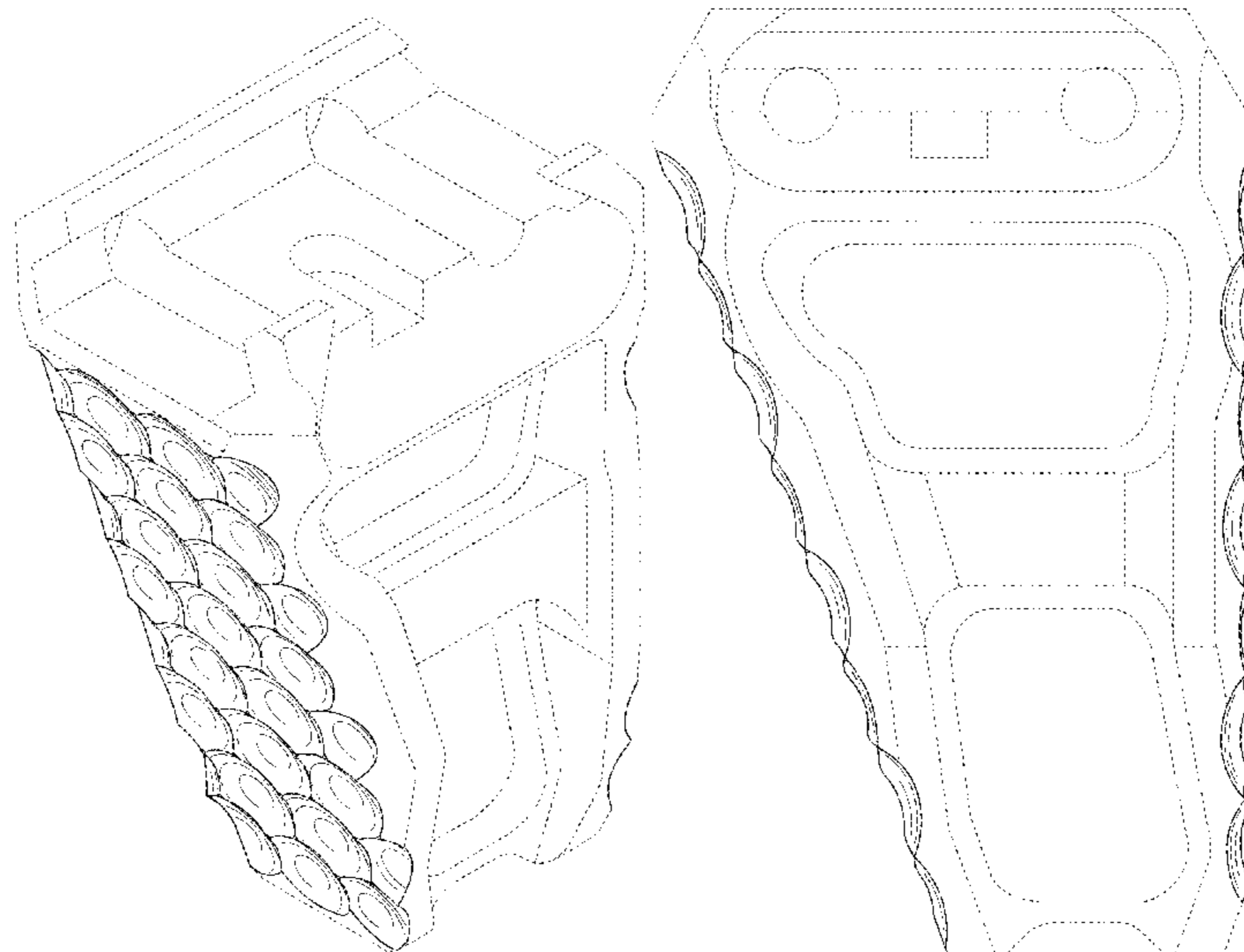

(56)

References Cited

U.S. PATENT DOCUMENTS

D795,983	S *	8/2017	Cross	D22/108
D797,878	S *	9/2017	Wang	D22/108
9,777,984	B1 *	10/2017	Bonine	F41C 23/10
D804,604	S *	12/2017	Shelton	D22/108
D808,493	S *	1/2018	Lee	D22/108
10,054,391	B1 *	8/2018	Lyman	F41C 3/00
10,060,699	B1 *	8/2018	Hu	F41C 23/04
D832,969	S *	11/2018	Cross	D22/108
D842,420	S *	3/2019	Liu	D22/108
D847,933	S *	5/2019	Windfeldt	D22/108
2004/0049963	A1 *	3/2004	Christiansen	F41C 23/10
					42/71.02
2015/0300775	A1 *	10/2015	Combs	F41C 23/16
					42/72
2017/0131051	A1 *	5/2017	Albury	F41A 11/00
2017/0299296	A1 *	10/2017	Dees	F41A 3/66
2017/0307328	A1 *	10/2017	Shelton	F41C 27/00

* cited by examiner

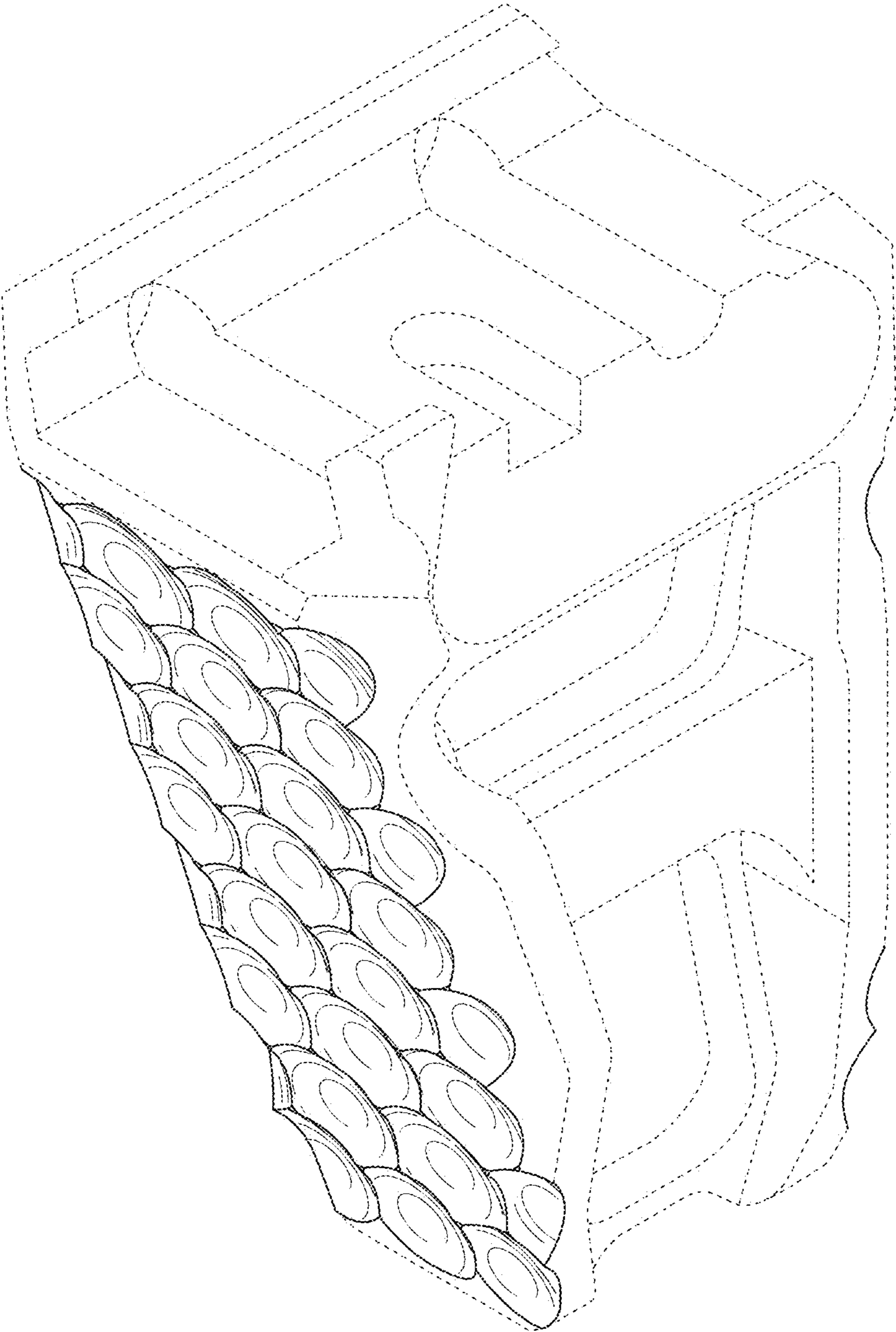

FIG. 1

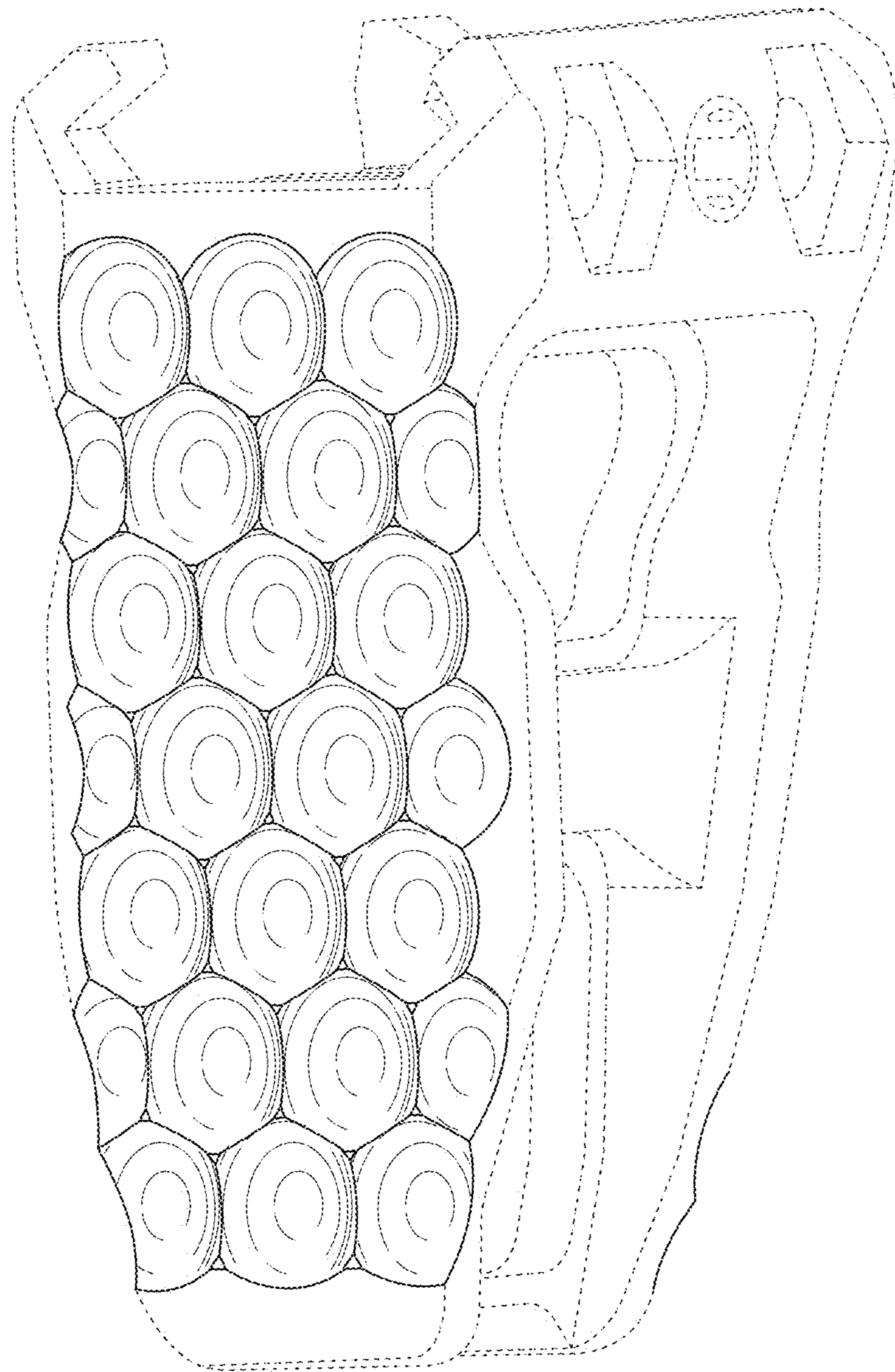

FIG. 2

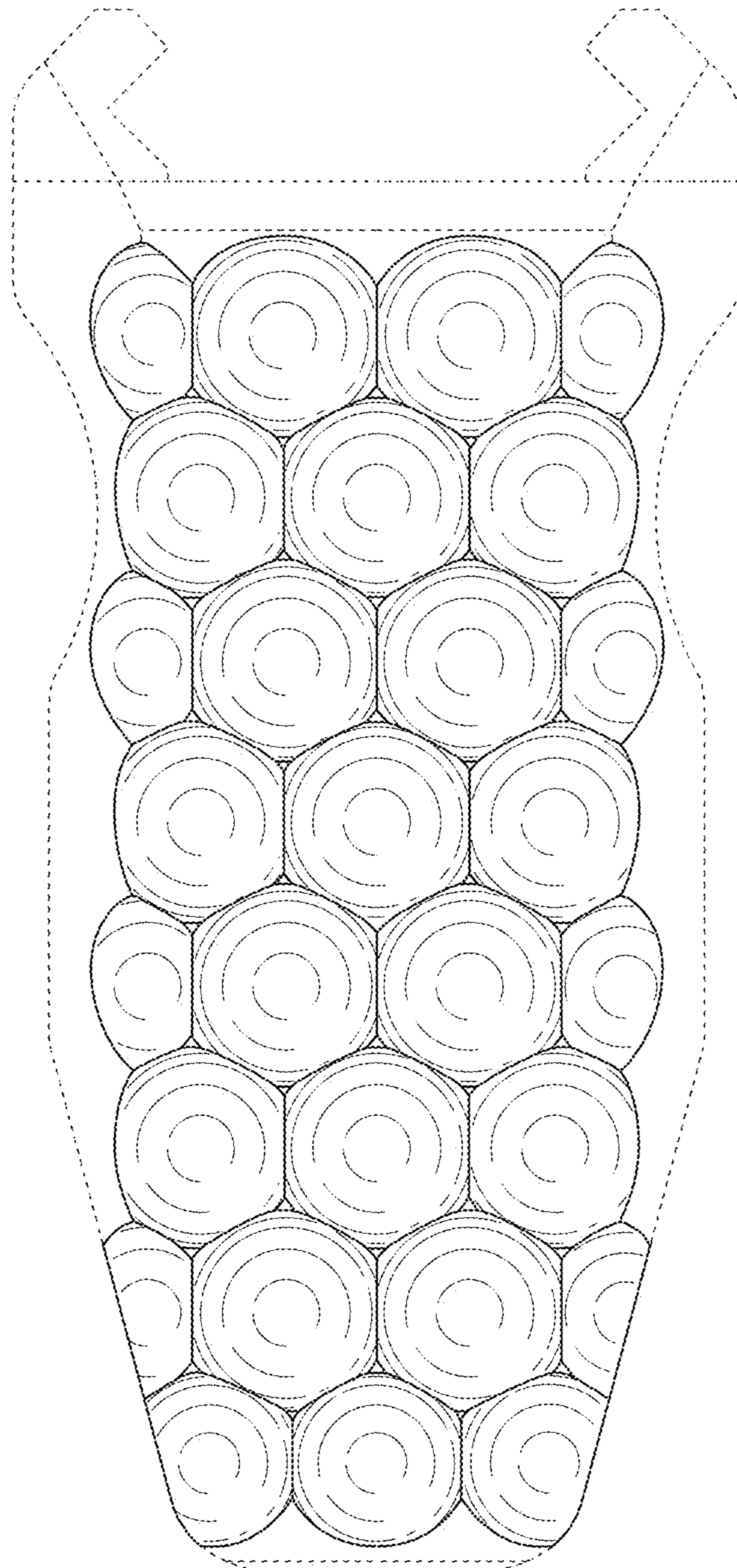

FIG. 3

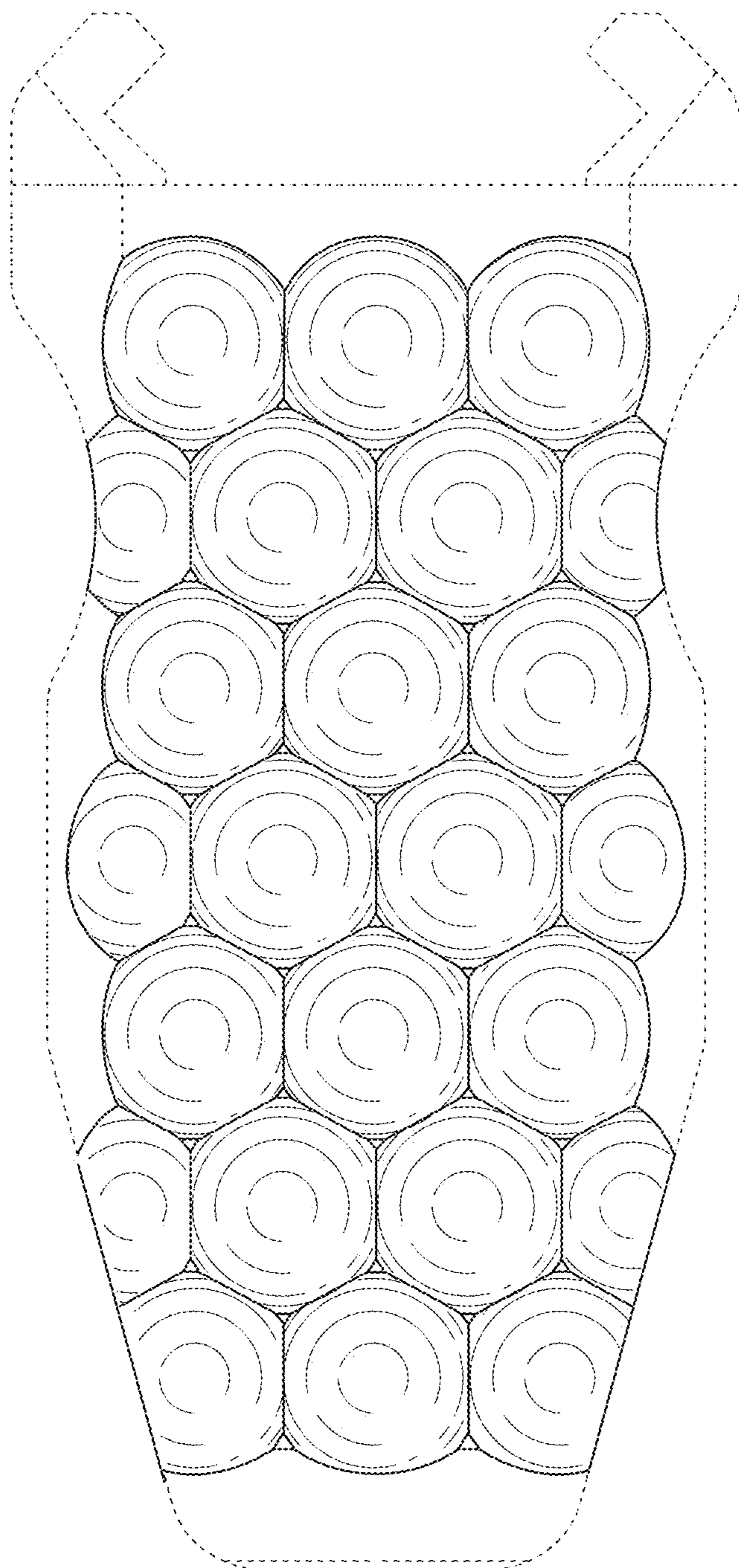

FIG. 4

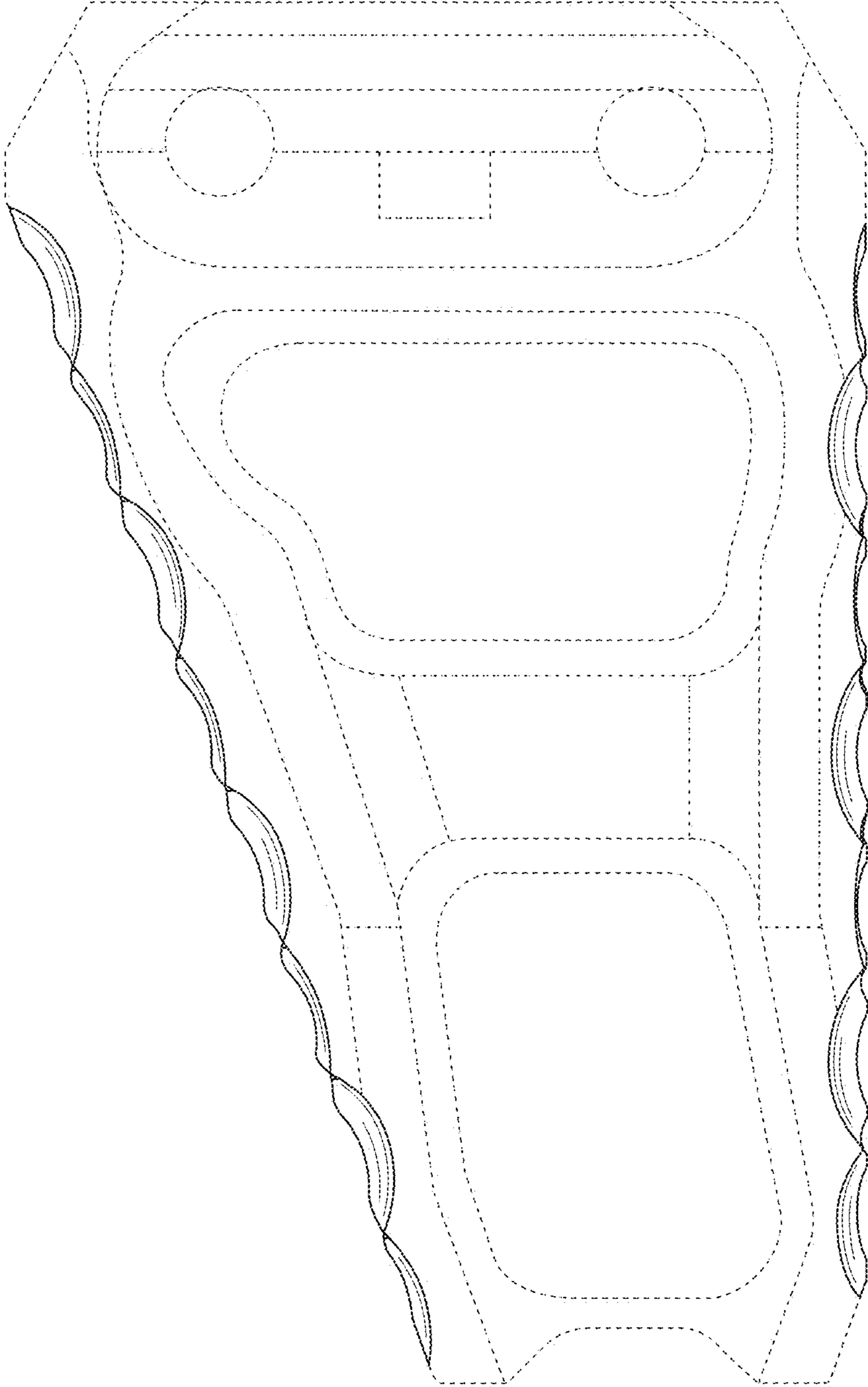

FIG. 5

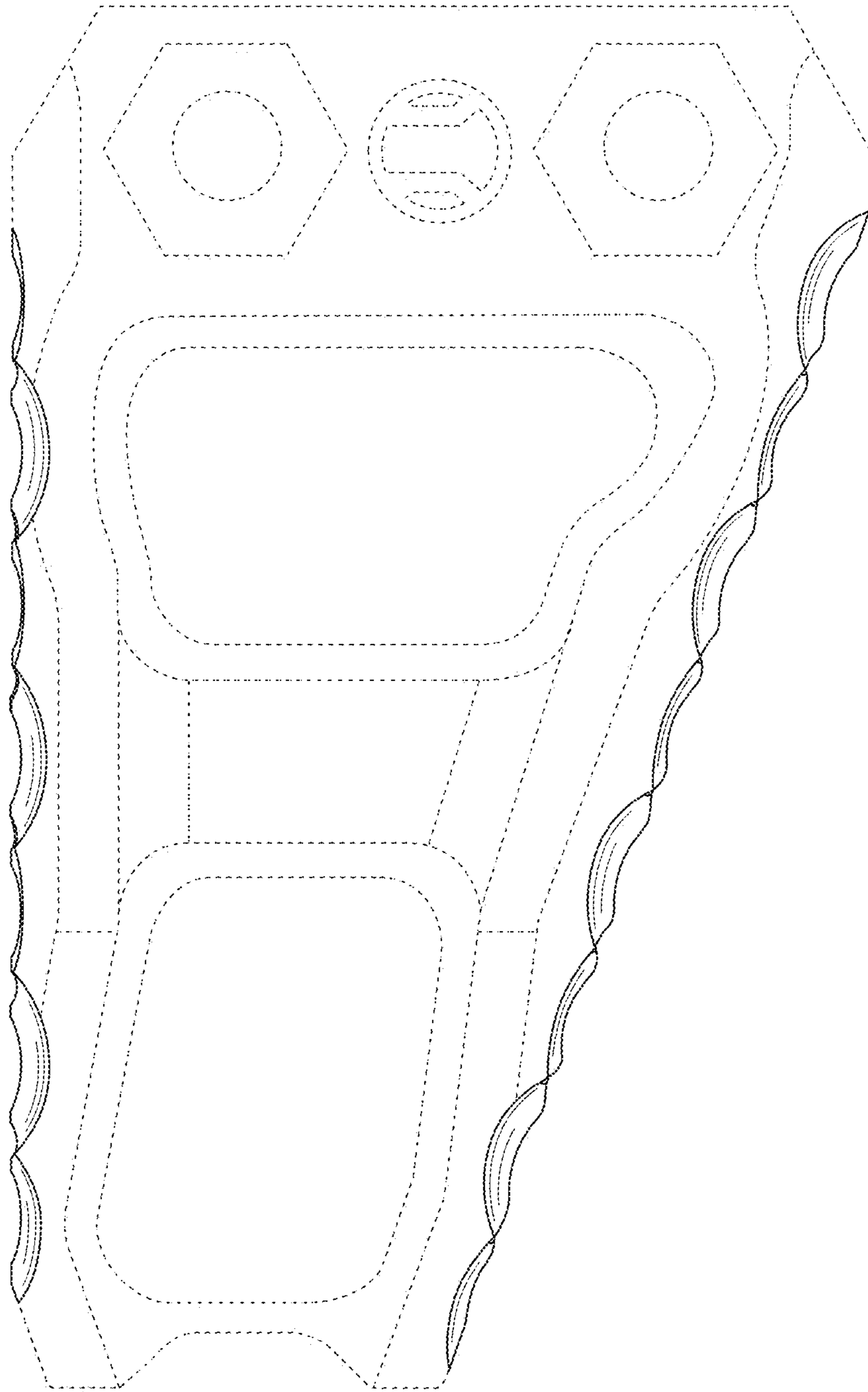

FIG. 6

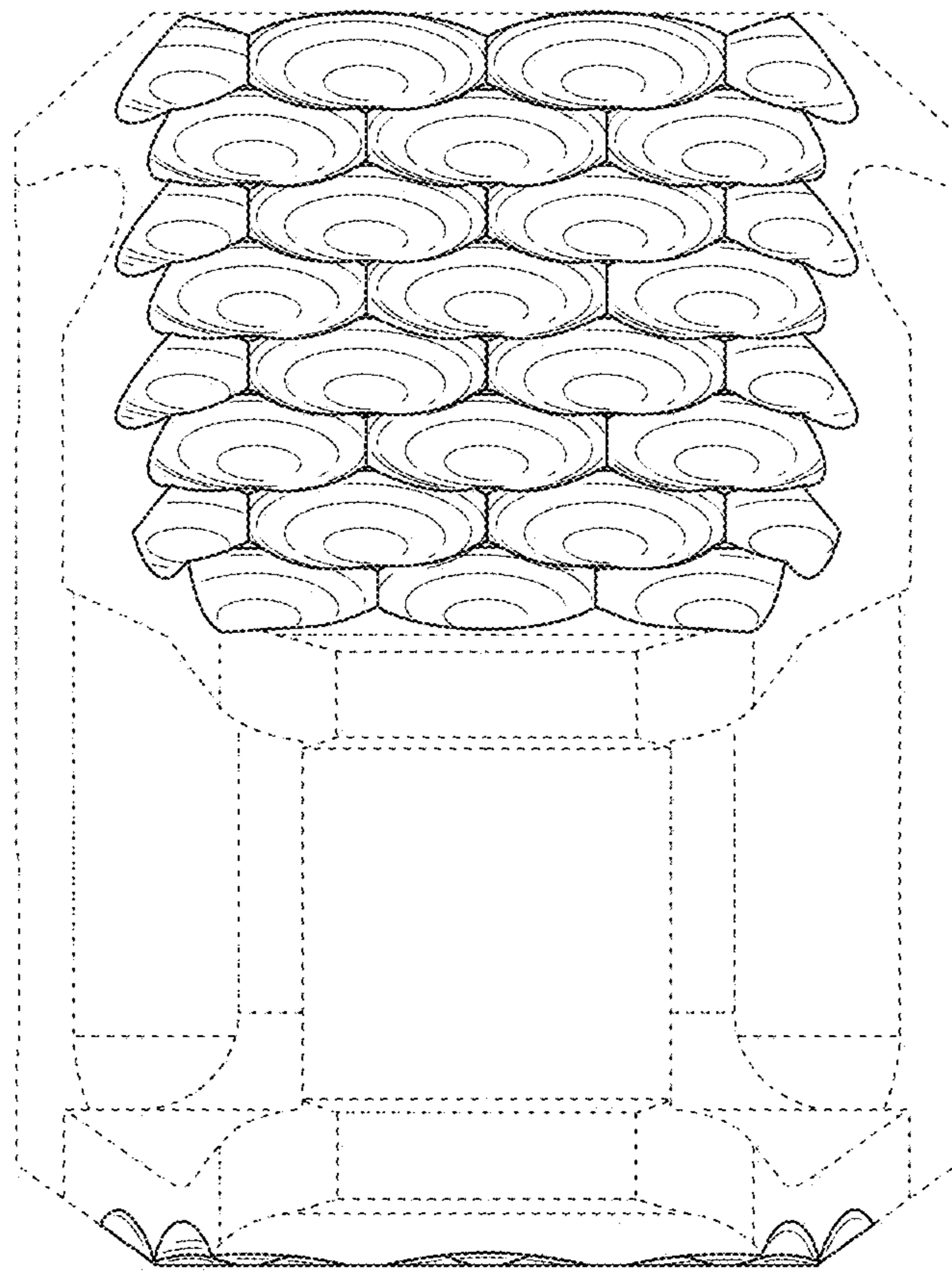

FIG. 7

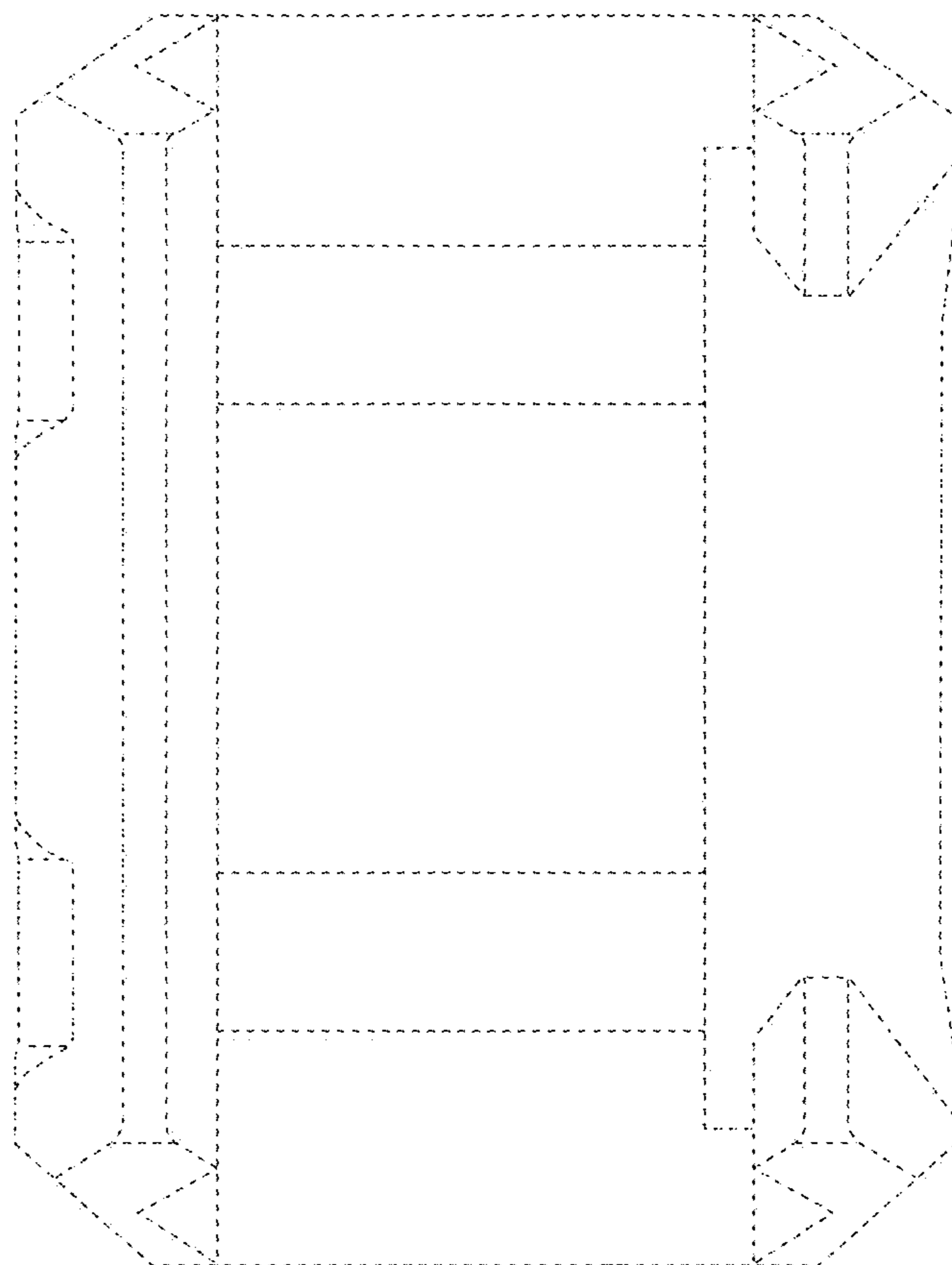

FIG. 8

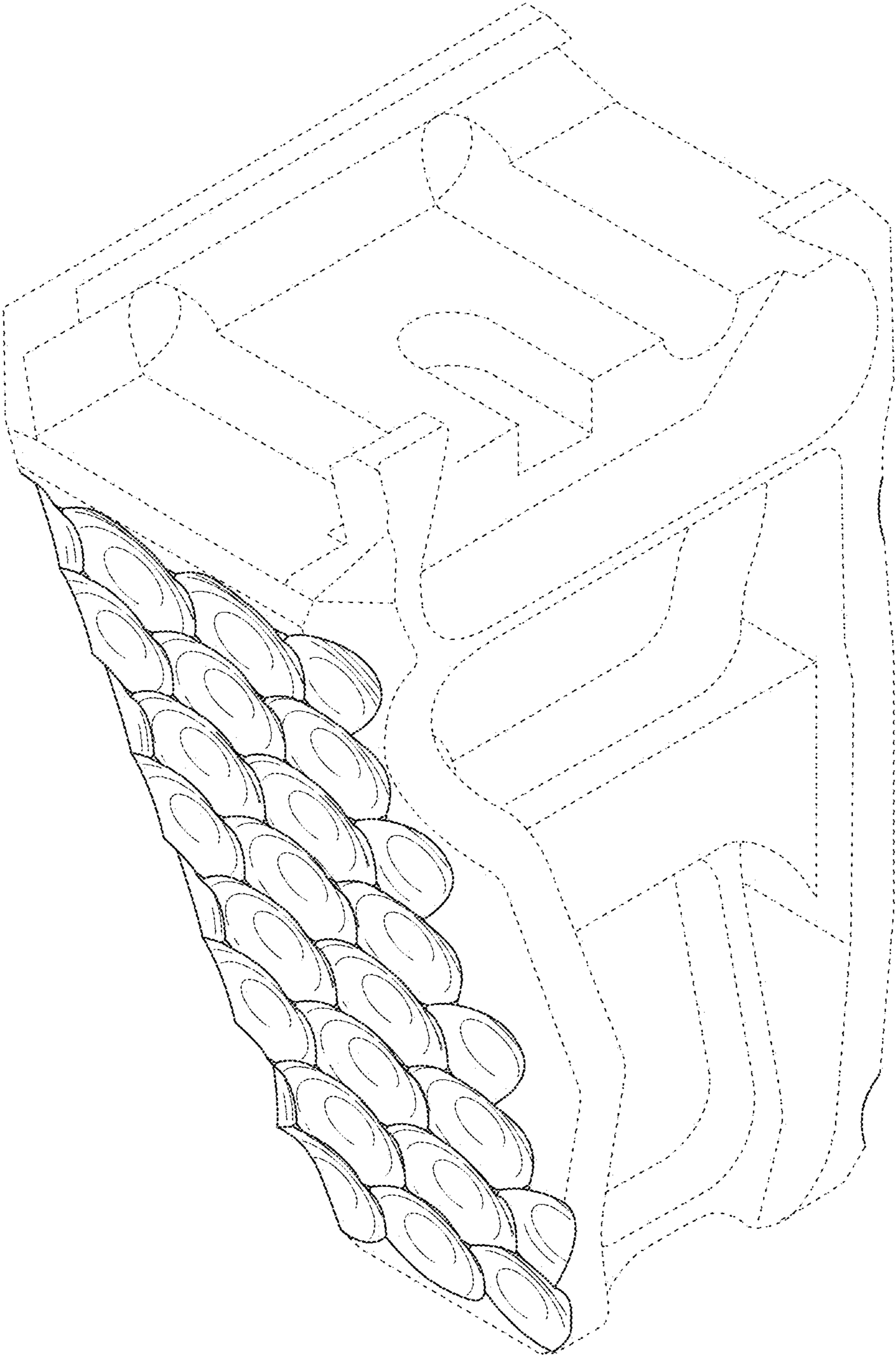

FIG. 9

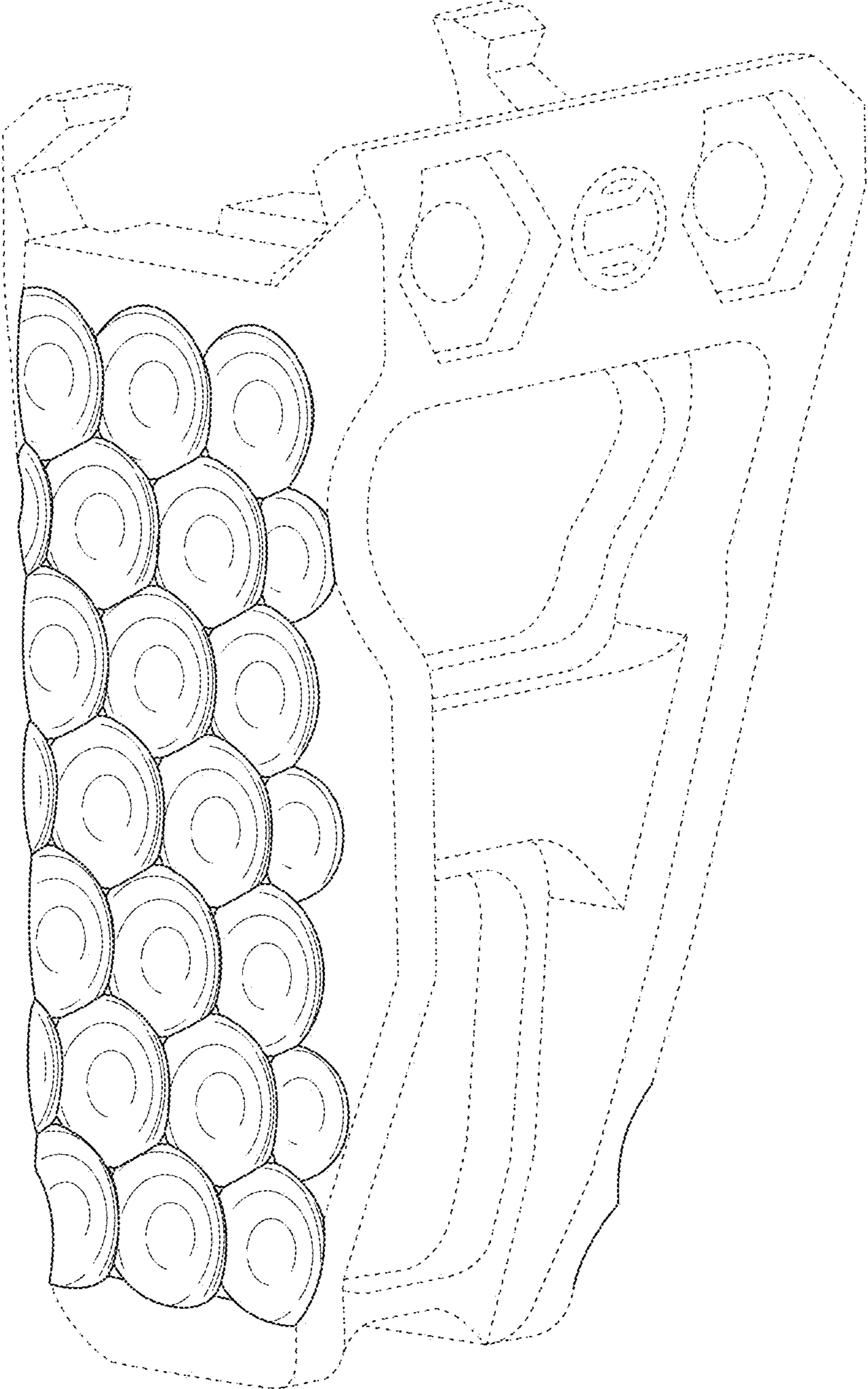

FIG. 10

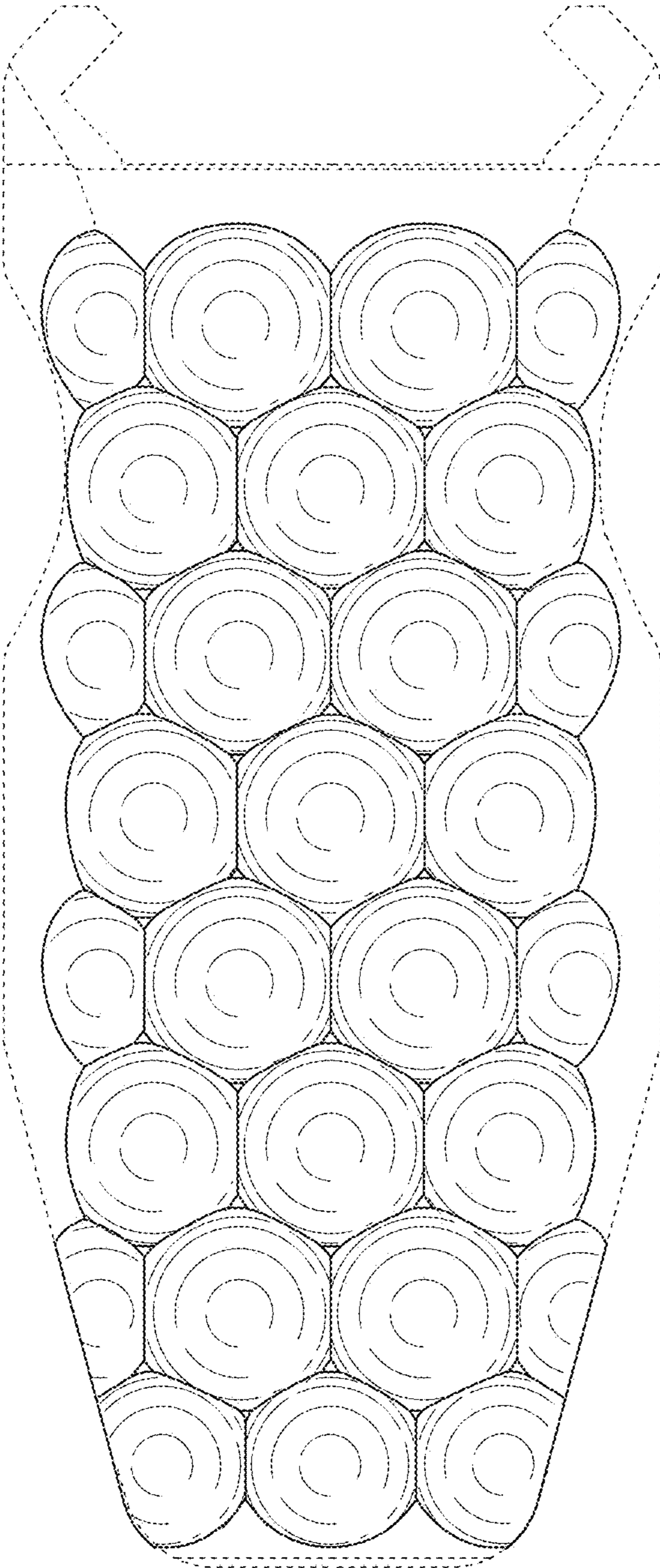

FIG. 11

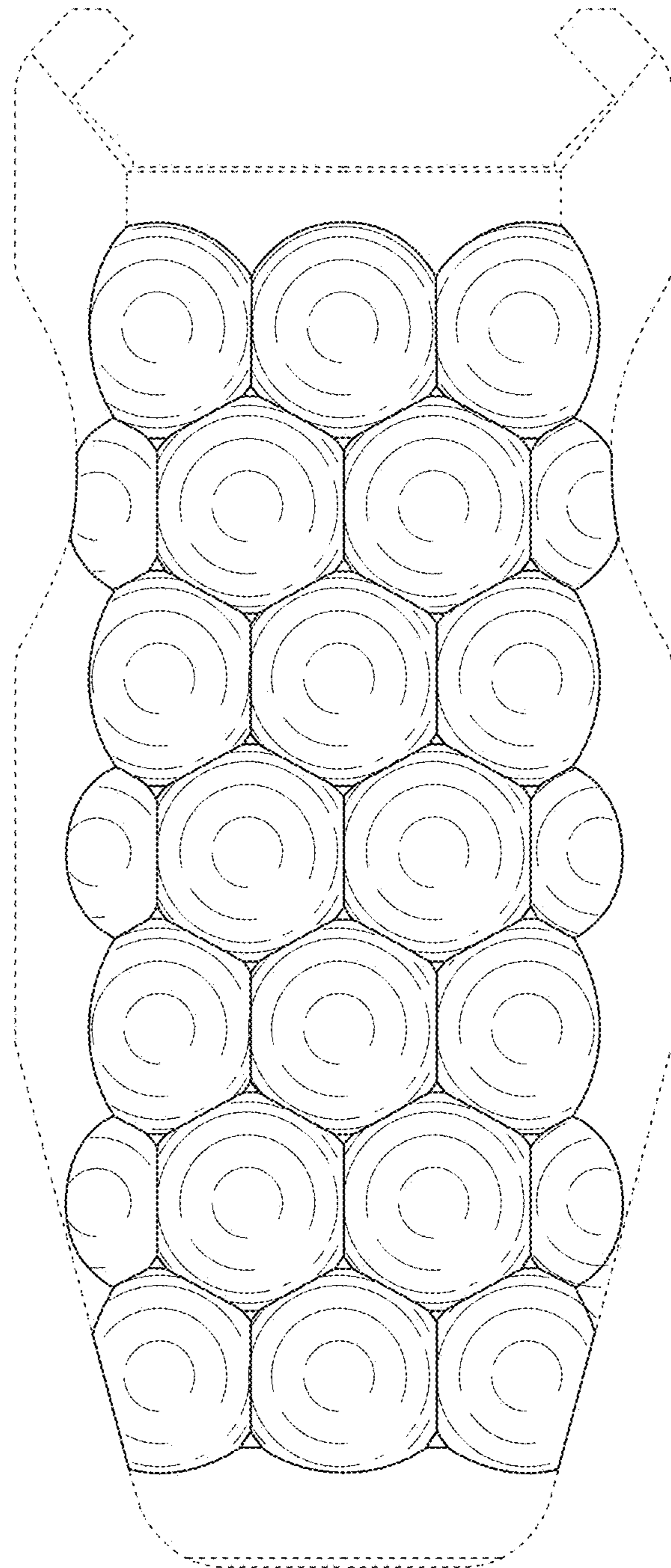

FIG. 12

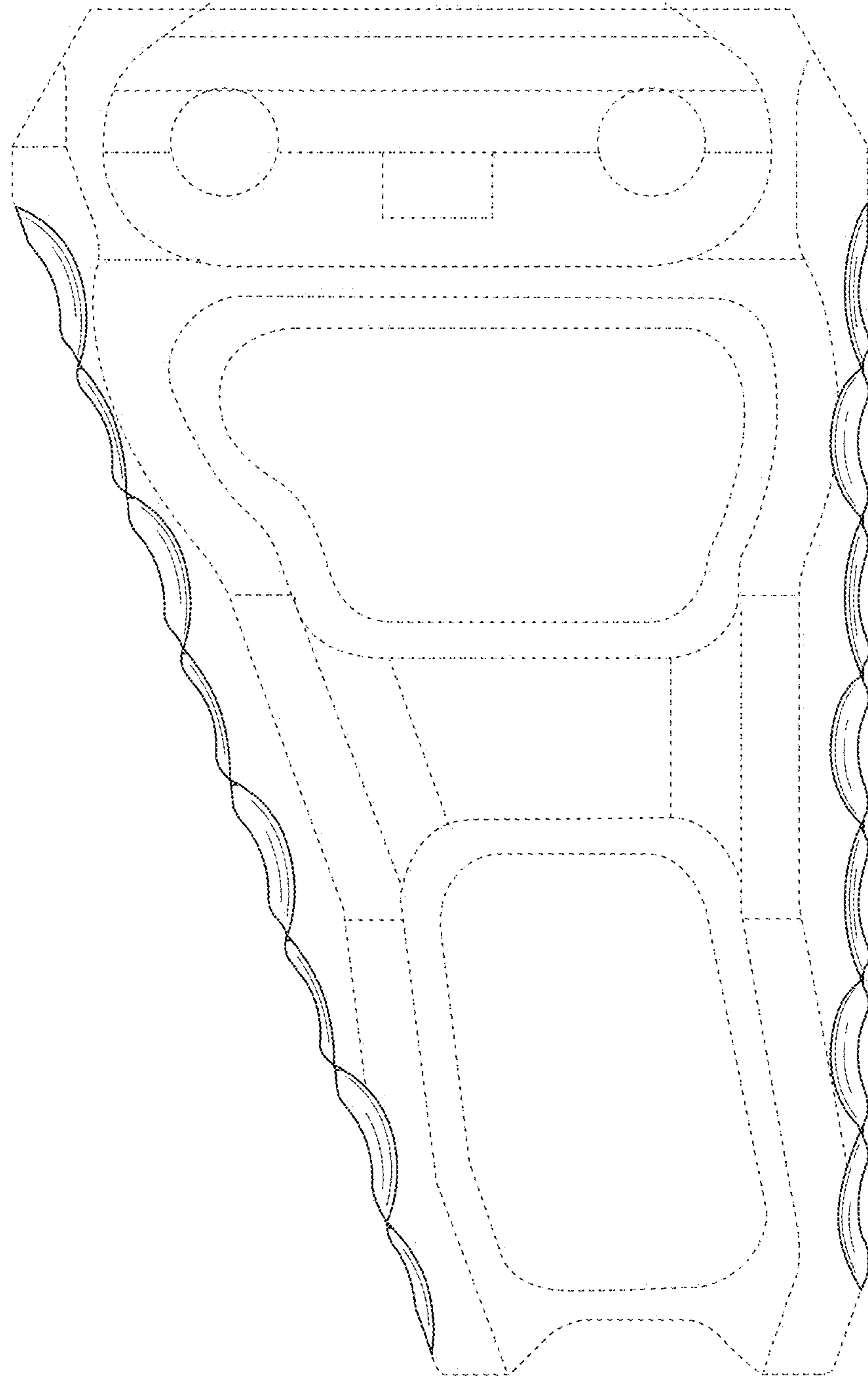

FIG. 13

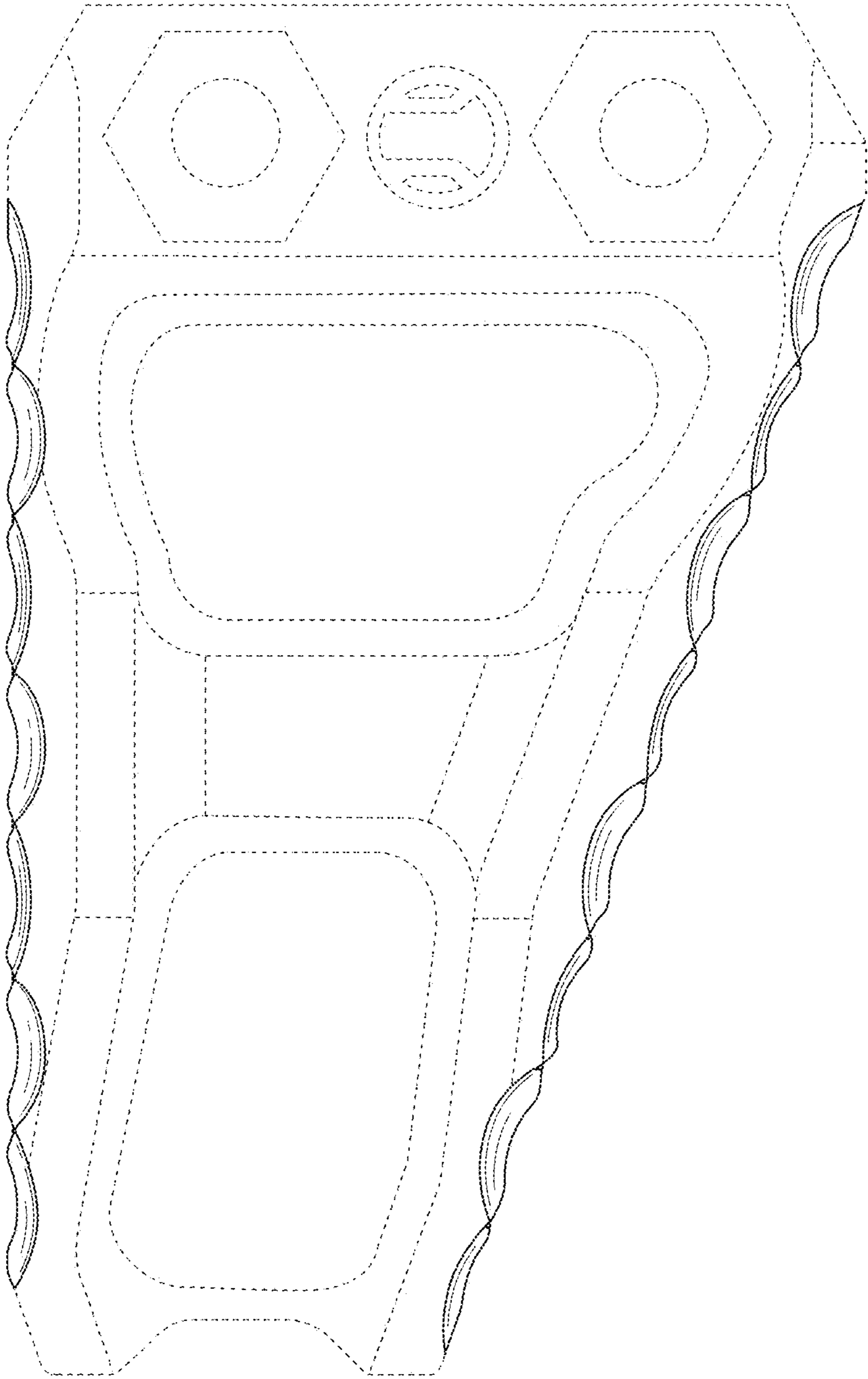

FIG. 14

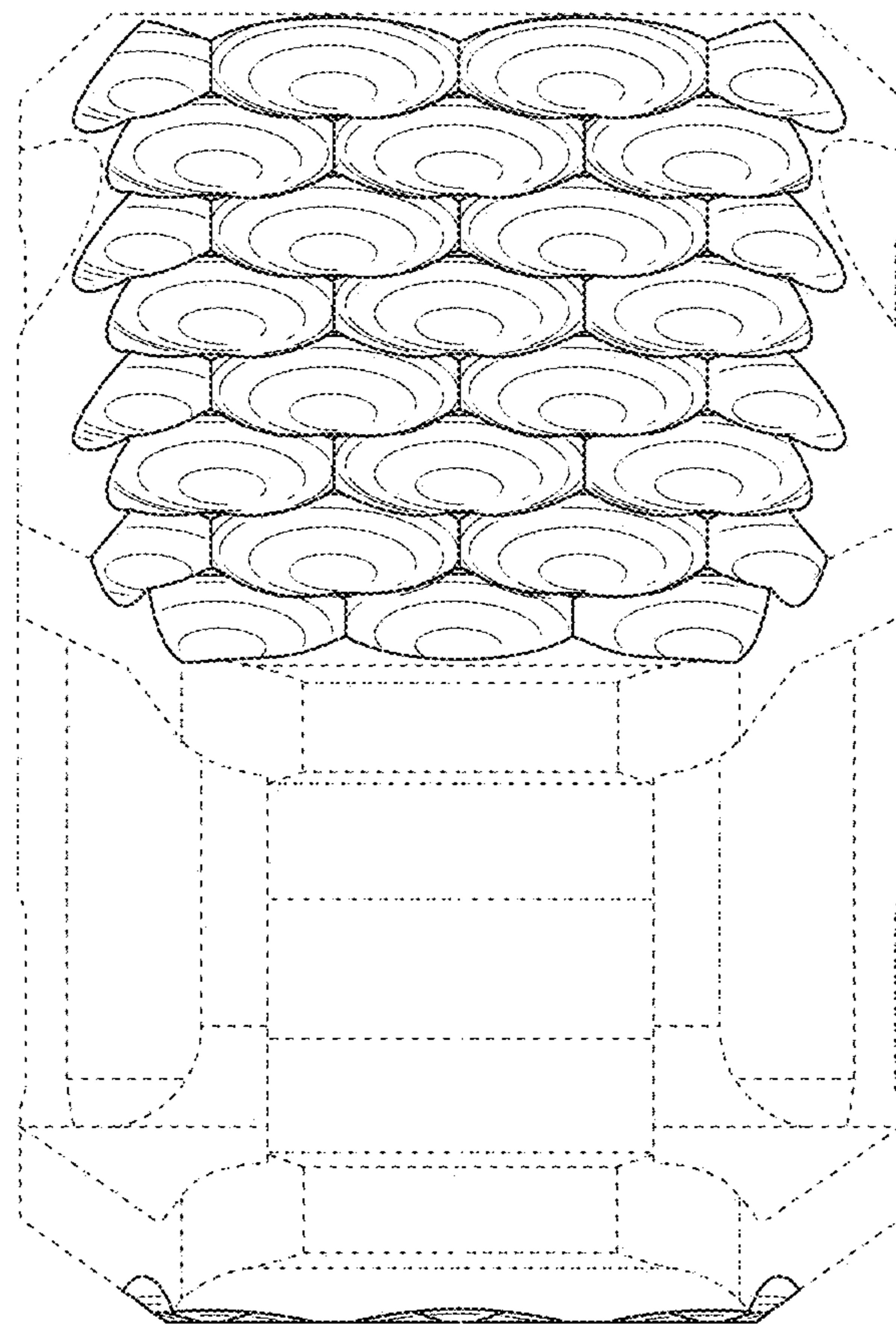

FIG. 15

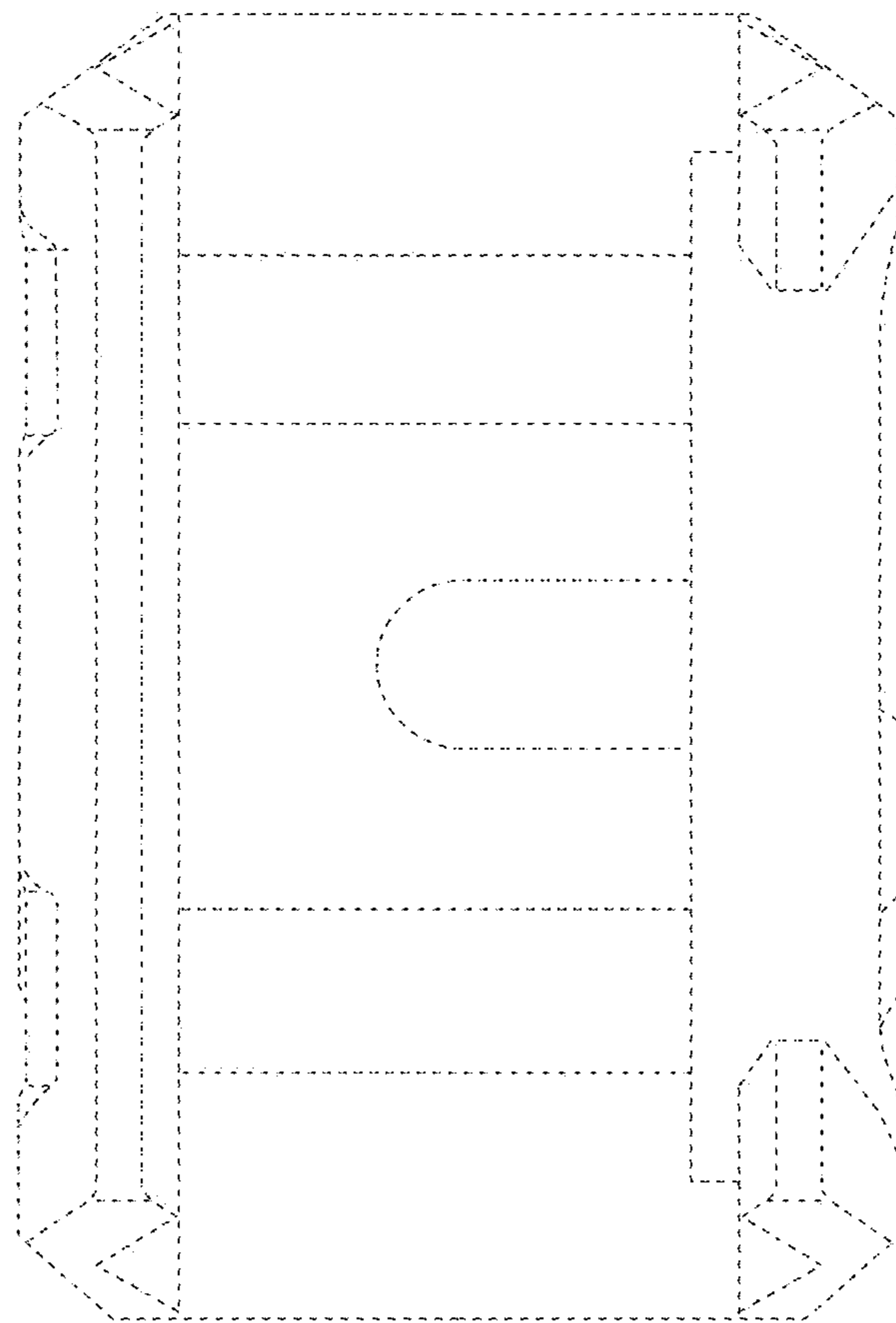

FIG. 16