



US00D873351S

(12) **United States Design Patent**
Horikoshi et al.

(10) **Patent No.:** **US D873,351 S**

(45) **Date of Patent:** **** Jan. 21, 2020**

(54) **ACCESSORY FOR SPINNING TOP TOY**
(71) Applicant: **TOMY COMPANY, LTD.**, Tokyo (JP)
(72) Inventors: **Kenji Horikoshi**, Tokyo (JP); **Hiroyuki Matsukawa**, Tokyo (JP)

D852,281 S * 6/2019 Horikoshi D21/460
D854,627 S * 7/2019 Saito D21/460
D854,628 S * 7/2019 Saito D21/460
D855,118 S * 7/2019 Saito D21/460
D855,119 S * 7/2019 Saito D21/460
2014/0302743 A1* 10/2014 Cai A63H 1/18
446/256

(73) Assignee: **TOMY COMPANY, LTD.**, Tokyo (JP)

FOREIGN PATENT DOCUMENTS

(**) Term: **15 Years**

CN 300948029 * 6/2009
CN 302044632 * 8/2012
CN 302143908 * 10/2012
CN 302232850 * 12/2012
CN 302902767 * 8/2014
CN 303794519 * 8/2016
CN 303863705 * 9/2016

(21) Appl. No.: **29/665,664**

(22) Filed: **Oct. 5, 2018**

(30) **Foreign Application Priority Data**

(Continued)

May 22, 2018 (JP) 2018-011143

Primary Examiner — Catherine A Tuttle

(51) **LOC (12) Cl.** **21-01**

(74) *Attorney, Agent, or Firm* — Oliff PLC

(52) **U.S. Cl.**
USPC **D21/460**

(57) **CLAIM**

(58) **Field of Classification Search**
USPC D21/455–464; 446/236–266
CPC A63H 1/00–32
See application file for complete search history.

The ornamental design for an accessory for spinning top toy, as shown and described.

DESCRIPTION

(56) **References Cited**

U.S. PATENT DOCUMENTS

D629,051 S * 12/2010 Nishimoto D21/460
D646,729 S * 10/2011 Ujita D21/460
D825,672 S * 8/2018 Muraki D21/460
D827,046 S * 8/2018 Horikoshi D21/460
D828,456 S * 9/2018 Muraki D21/460
D837,899 S * 1/2019 Narita D21/460
D841,099 S * 2/2019 Matsukawa D21/460
D846,034 S * 4/2019 Horikawa D21/460
D849,849 S * 5/2019 Muraki D21/460
D851,709 S * 6/2019 Muraki D21/460
D852,280 S * 6/2019 Horikoshi D21/460

FIG. 1 is a front elevational view of the accessory for spinning top toy;
FIG. 2 is a rear elevational view thereof;
FIG. 3 is a left-side elevational view thereof;
FIG. 4 is a right-side elevational view thereof;
FIG. 5 is a top plan view thereof;
FIG. 6 is a bottom plan view thereof;
FIG. 7 is a front, top and right side perspective view thereof;
FIG. 8 is a disassembled front, top and right side perspective view thereof; and,
FIG. 9 is a disassembled rear, bottom and left side perspective view thereof.

1 Claim, 9 Drawing Sheets

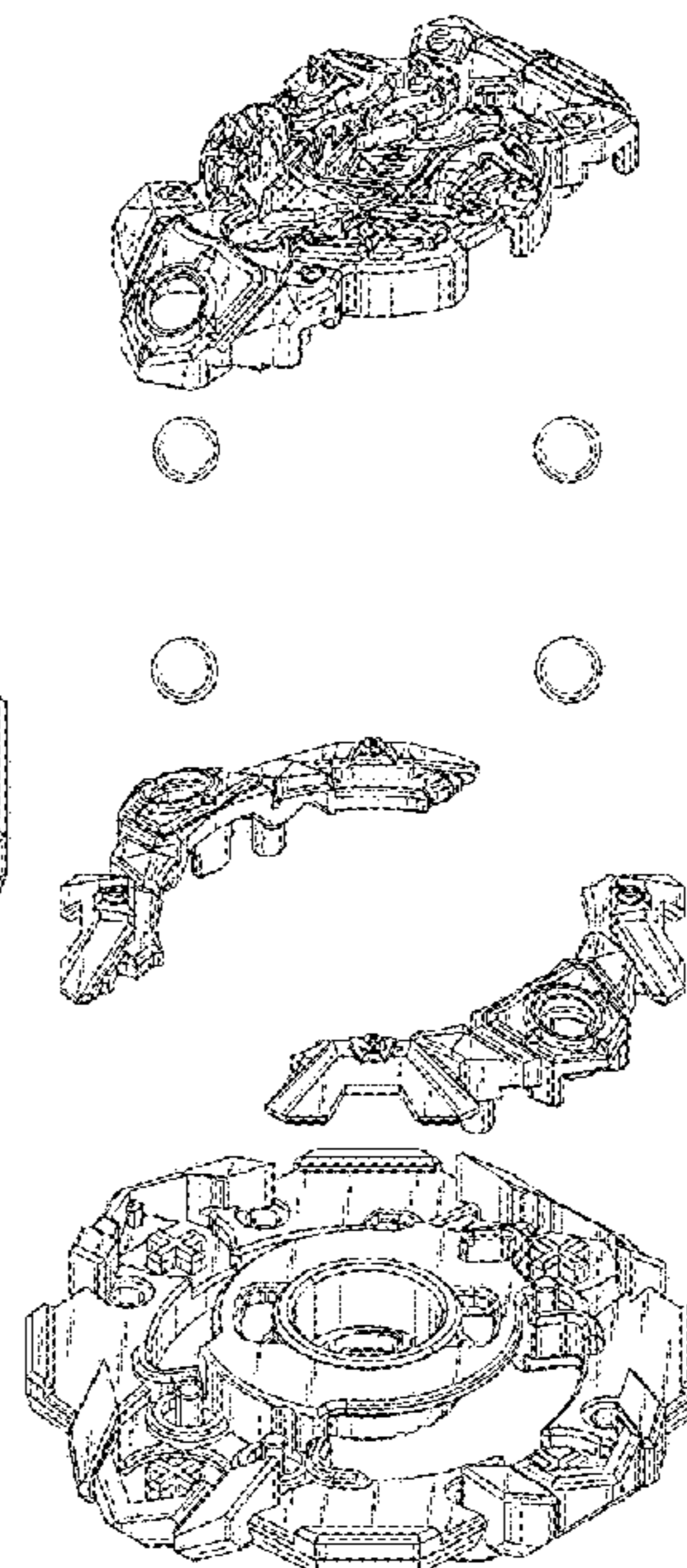
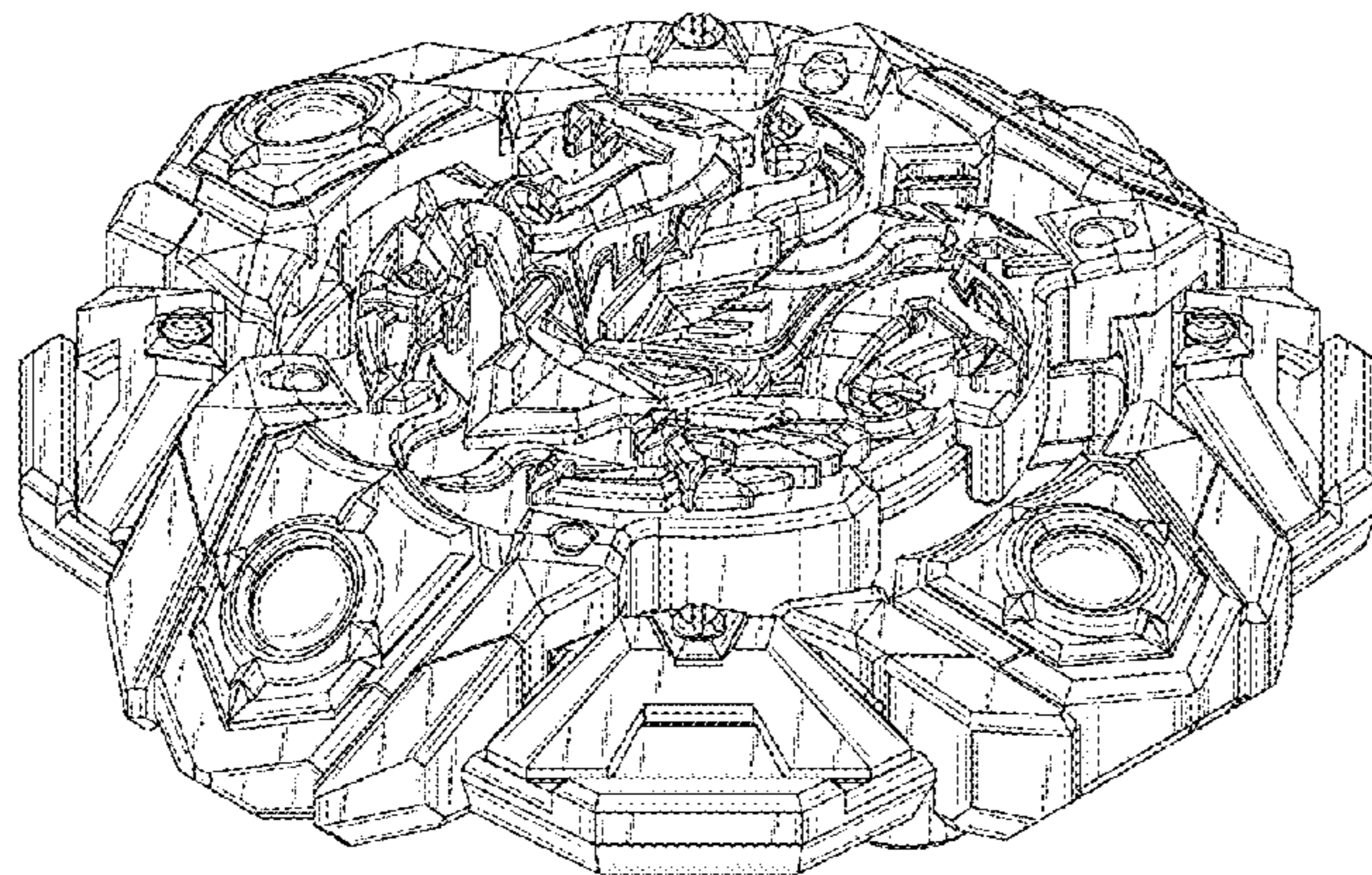

(56)

References Cited

FOREIGN PATENT DOCUMENTS

CN	303863727	*	9/2016	
CN	303970411	*	12/2016	
JP	3160657	U *	7/2010 A63H 1/00
JP	6258541	B1 *	1/2018 A63H 1/04
JP	6377211	B1 *	8/2018 A63H 1/02
JP	6377217	B1 *	8/2018 A63H 1/02

* cited by examiner

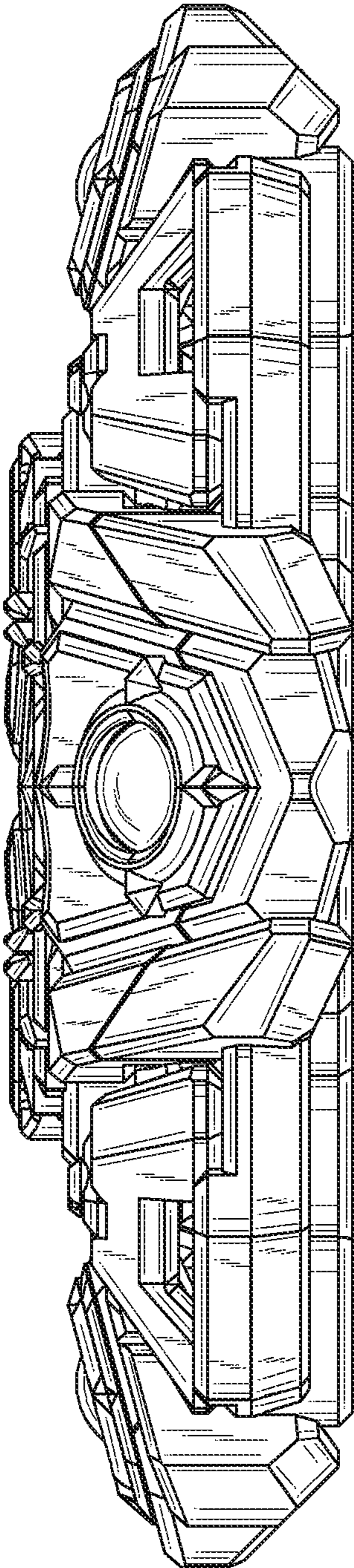

FIG. 1

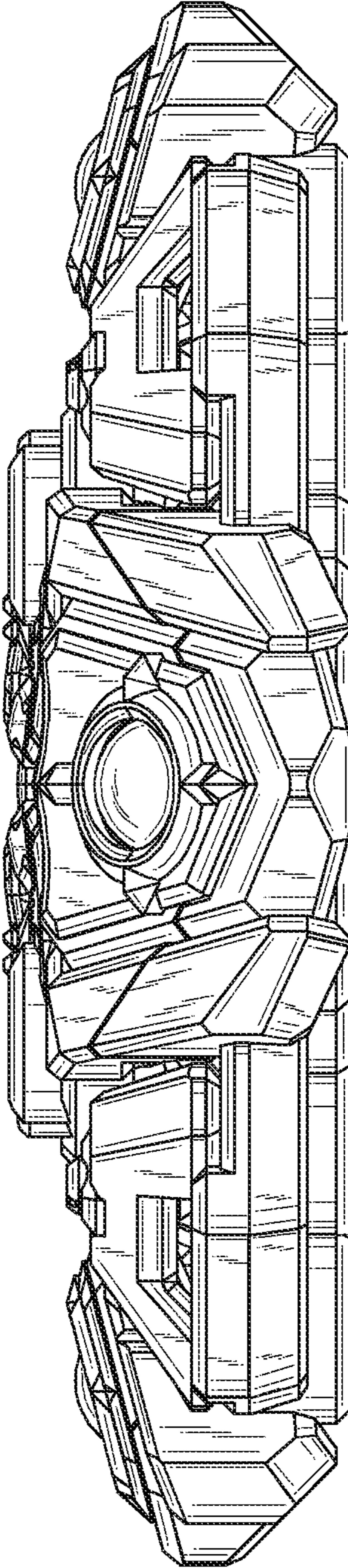

FIG. 2

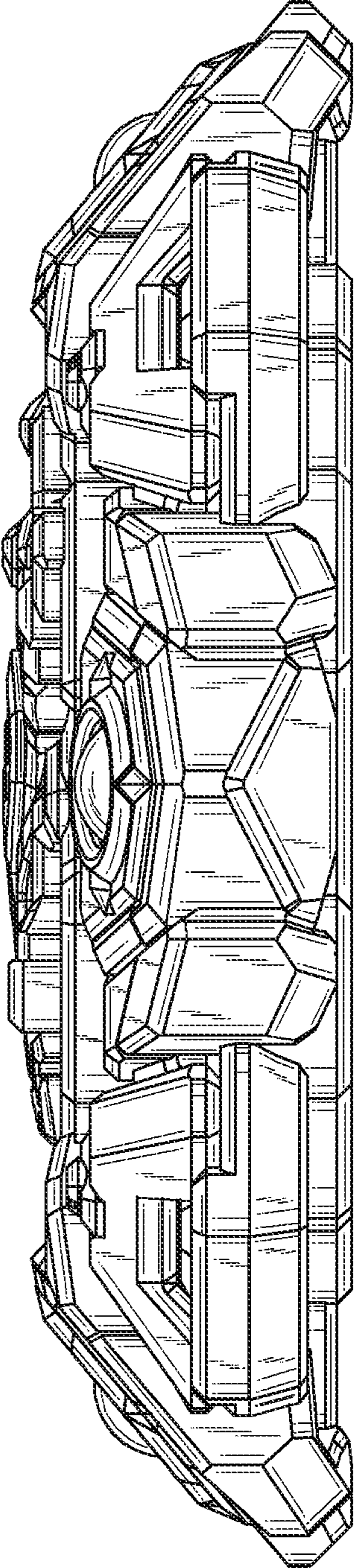

FIG. 3

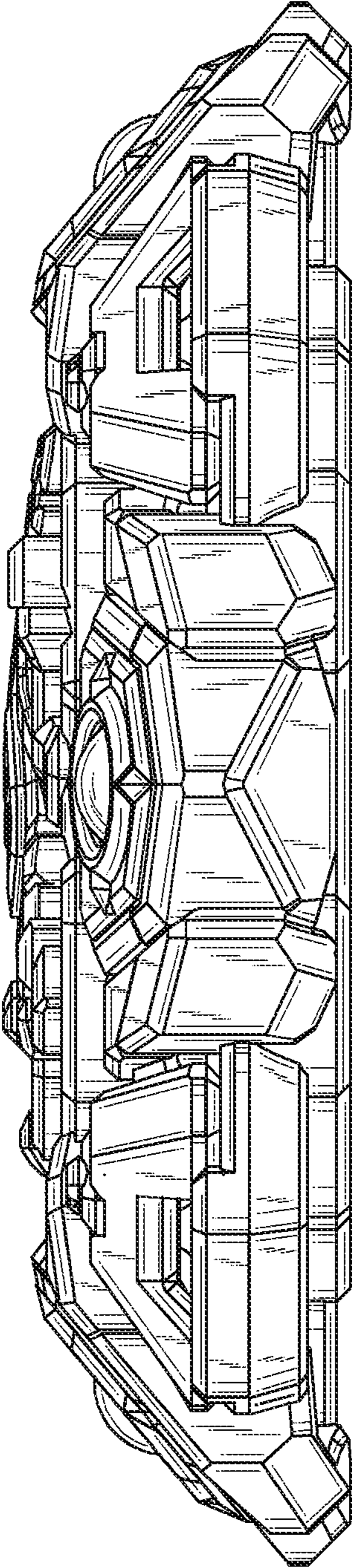

FIG. 4

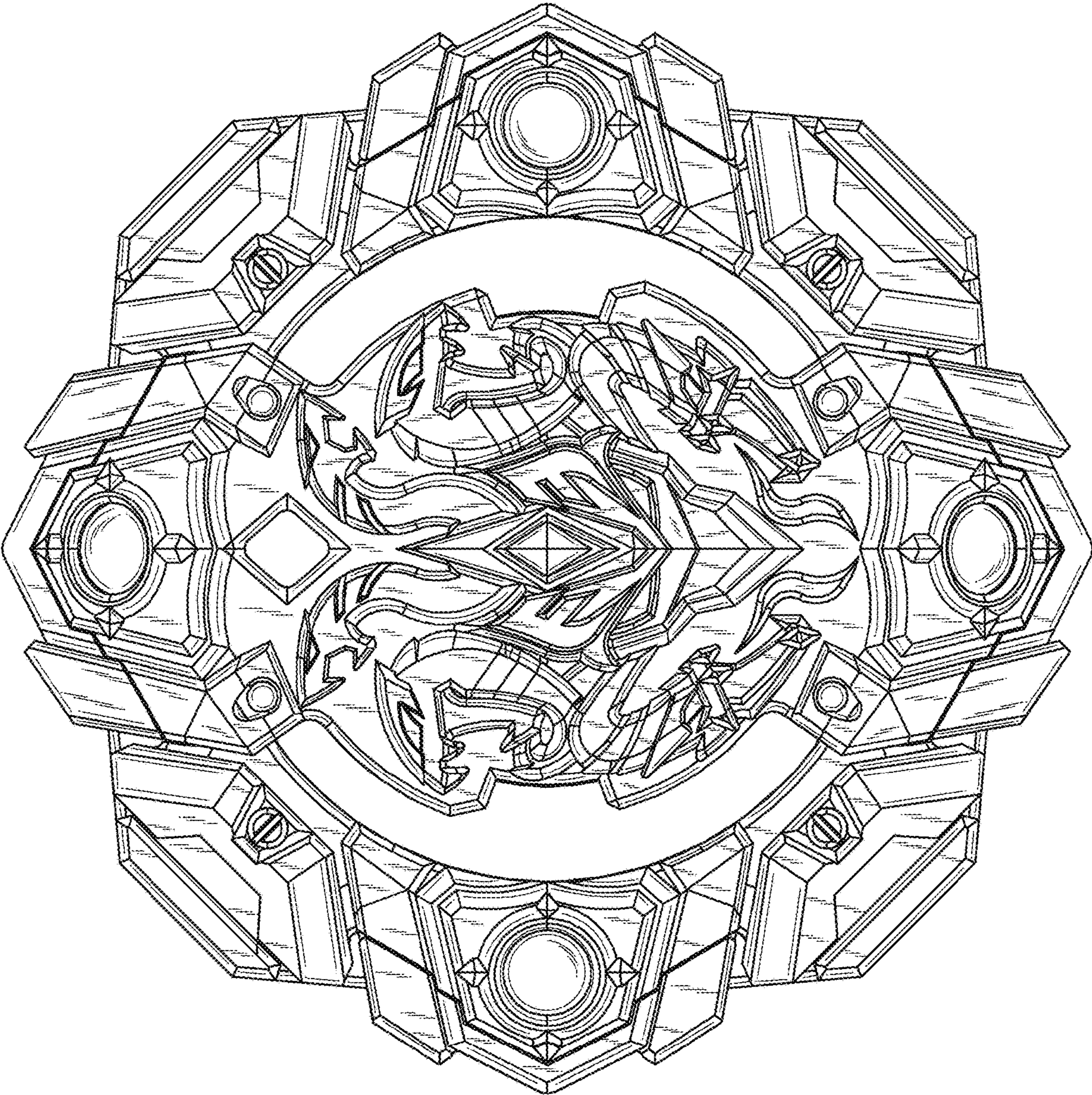

FIG. 5

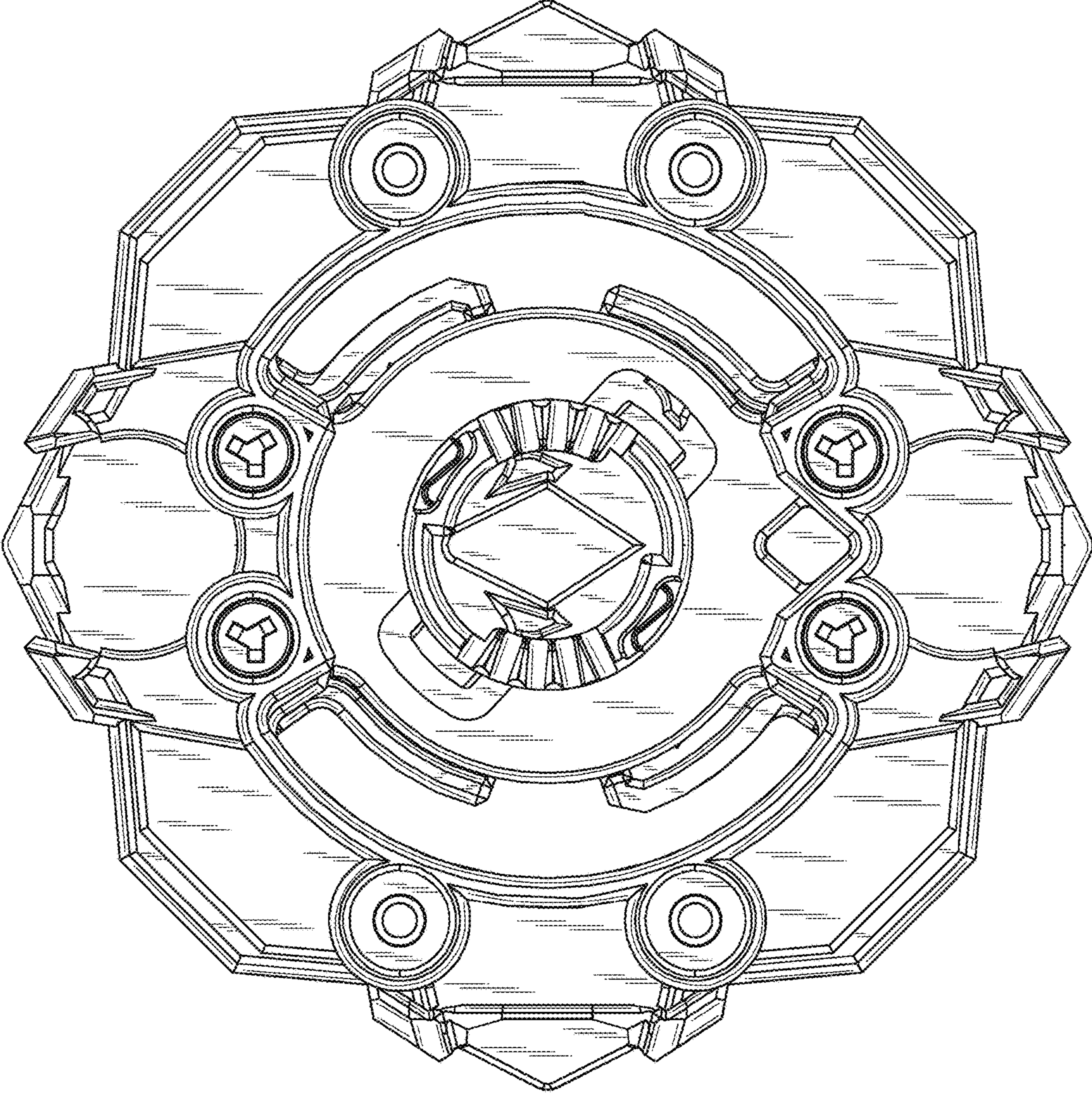

FIG. 6

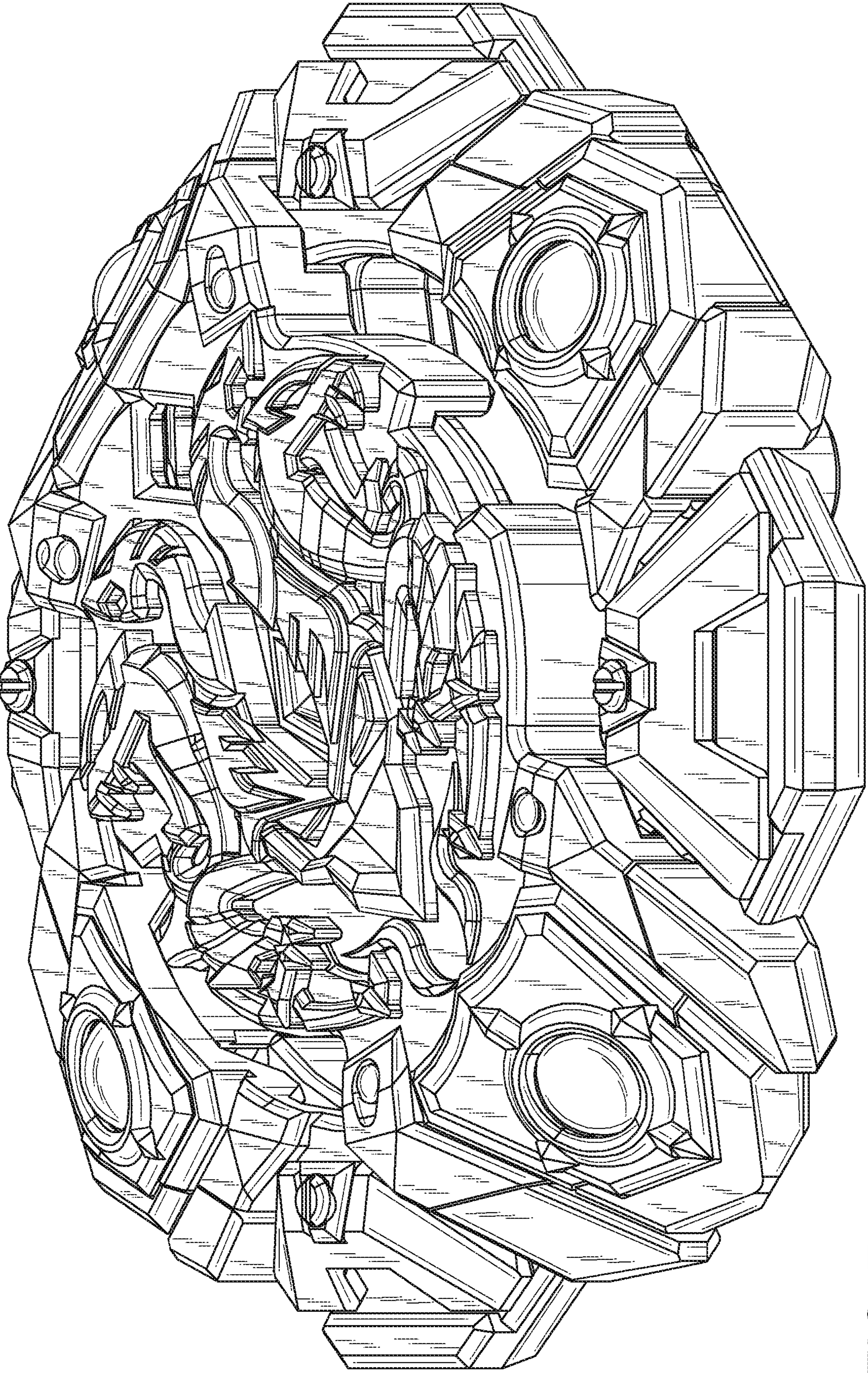

FIG. 7

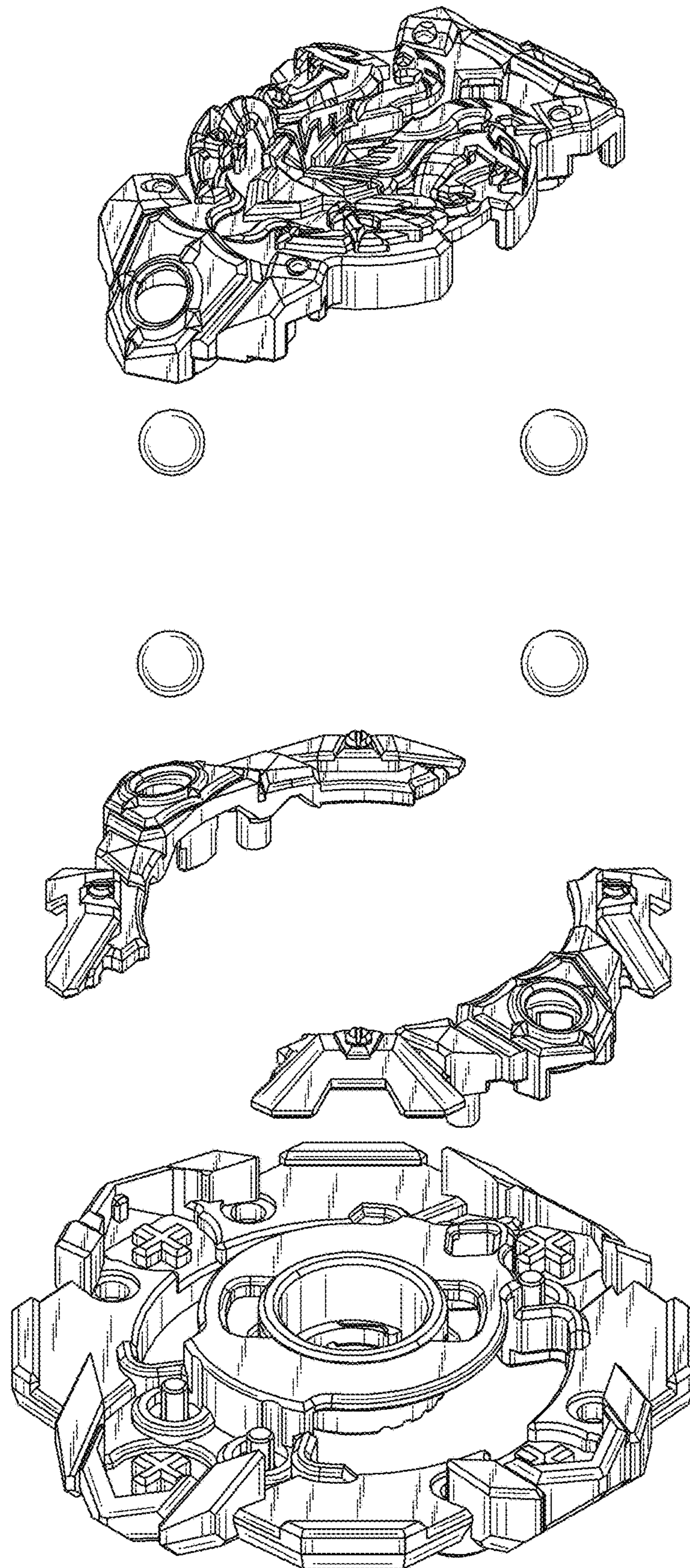

FIG. 8

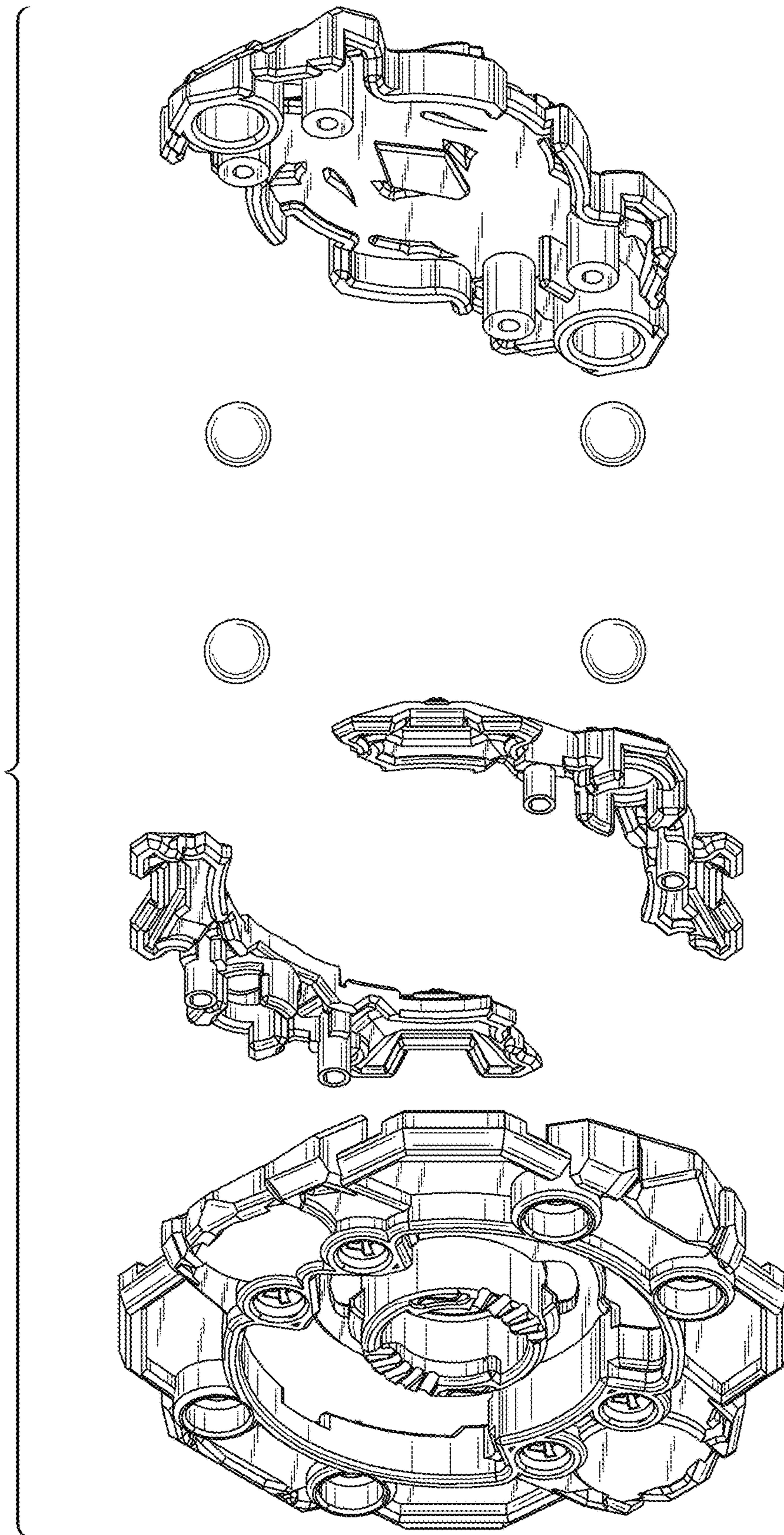

FIG. 9