



US00D873258S

(12) **United States Design Patent**
Park et al.

(10) **Patent No.:** **US D873,258 S**
(45) **Date of Patent:** **** *Jan. 21, 2020**

(54) **ELECTRONIC DEVICE**

(71) Applicant: **SAMSUNG ELECTRONICS CO., LTD.**, Suwon-si (KR)

(72) Inventors: **Hyoungshin Park**, Seoul (KR);
Seungho Jang, Seongnam-si (KR);
Dongkyun Kim, Seoul (KR);
Seonkeun Park, Seoul (KR); **Yunjin Kim**, Seoul (KR)

(73) Assignee: **SAMSUNG ELECTRONICS CO., LTD.**, Gyeonggi-Do (KR)

(*) Notice: This patent is subject to a terminal disclaimer.

(**) Term: **15 Years**

(21) Appl. No.: **29/656,885**

(22) Filed: **Jul. 17, 2018**

(30) **Foreign Application Priority Data**

Jan. 19, 2018 (KR) 30-2018-0003418

(51) **LOC (12) Cl.** **14-03**

(52) **U.S. Cl.**
USPC **D14/248**

(58) **Field of Classification Search**
USPC D14/138 G, 248, 341, 371, 374, 138 R,
D14/138 AA, 138 AB, 138 AC, 138 AD,
D14/138 C, 247

CPC H04M 1/0202; H04M 1/0235; H04M
1/0237; H04M 1/0239; H04M 1/0266;
H04M 1/0268; H04M 1/027; H04M
1/0295

See application file for complete search history.

(56) **References Cited**

U.S. PATENT DOCUMENTS

D585,411 S * 1/2009 Eaton D14/138 G
D606,038 S * 12/2009 Aarras D14/138 G

D618,201 S * 6/2010 Hachiya D14/138 G
D627,782 S * 11/2010 Ichise D14/346
D631,464 S * 1/2011 Kim D14/138 G
D633,459 S * 3/2011 Suzuki D14/138 G
D634,292 S * 3/2011 Sadatsuki D14/138 AD
D640,224 S * 6/2011 Sadatsuki D14/138 AD

(Continued)

OTHER PUBLICATIONS

Nokia X6, announced May 2018, [online], [retrieved on Jun. 21, 2018]. Retrieved from Internet ,<URL: <http://www.gsmarena.com>>.*

(Continued)

Primary Examiner — Bridget L Eland

(74) *Attorney, Agent, or Firm* — Cantor Colburn LLP

(57) **CLAIM**

The ornamental design for an electronic device, as shown and described.

DESCRIPTION

FIG. 1 is a front perspective view of an electronic device showing our new design;

FIG. 2 is a front view thereof;

FIG. 3 is a rear view thereof;

FIG. 4 is a left-side view thereof;

FIG. 5 is a right-side view thereof;

FIG. 6 is a top view thereof;

FIG. 7 is a bottom view thereof; and,

FIG. 8 is a rear perspective view thereof.

The dot-dash broken lines and outermost broken lines immediately adjacent to the full line showing of the claimed design represent the bounds of the claimed design while all other broken lines are directed to environment and are for illustrative purposes only; the broken lines form no part of the claimed design. In addition, the unshaded surface between the solid line edge and broken line in FIGS. 1, 2, and 4-7 forms no part of the claimed design.

1 Claim, 6 Drawing Sheets

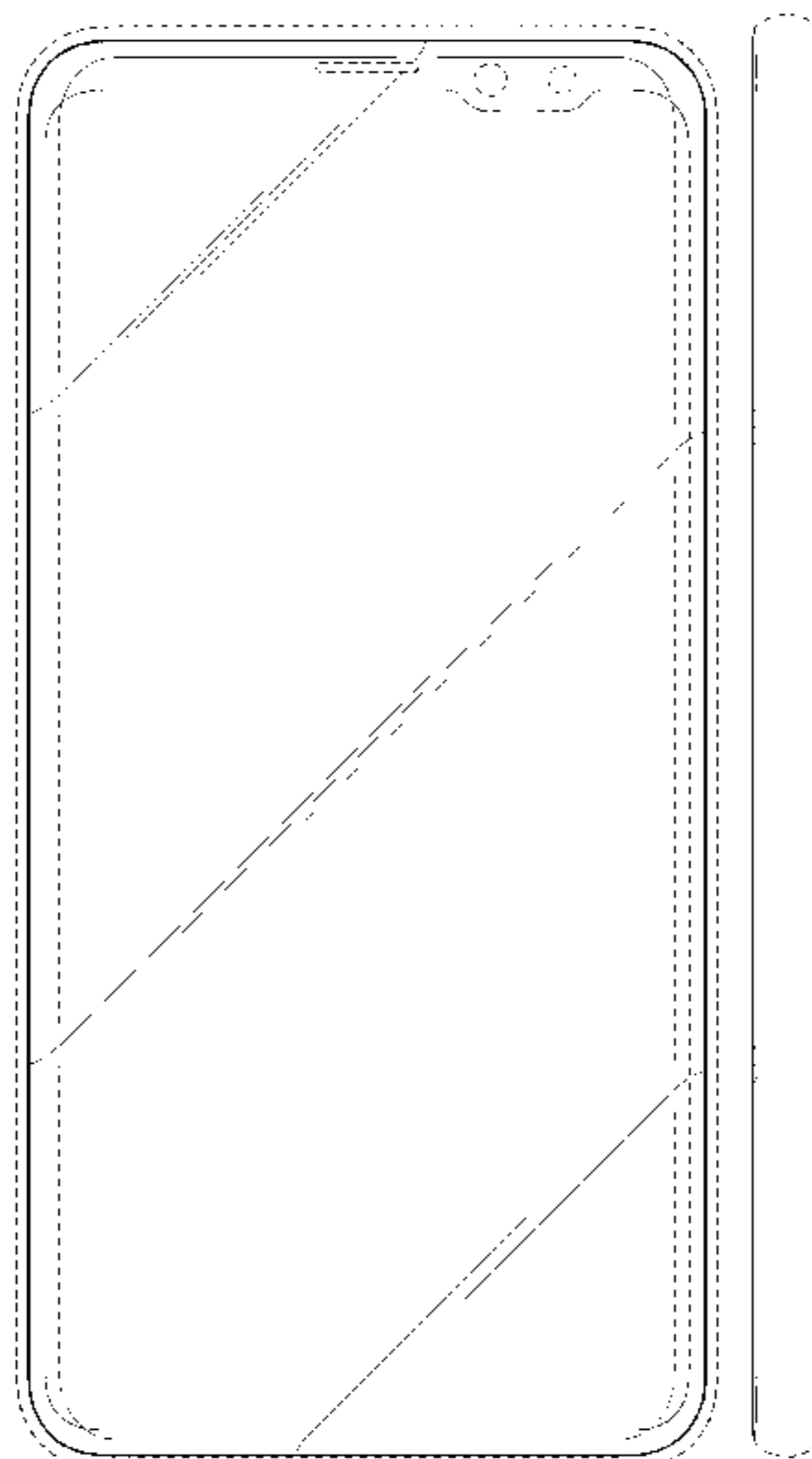

(56)

References Cited

U.S. PATENT DOCUMENTS

D646,251 S * 10/2011 Park D14/138 G
 D651,191 S * 12/2011 Kim D14/138 G
 D651,583 S * 1/2012 Park D14/138 G
 D659,667 S * 5/2012 Jung D14/138 AD
 D665,766 S * 8/2012 Eguchi D14/138 G
 8,437,811 B2 * 5/2013 Park H04M 1/035
 455/575.1
 D688,643 S * 8/2013 Park D14/138 G
 D694,213 S * 11/2013 Park D14/138 G
 D700,165 S * 2/2014 Chung D14/138 G
 D704,672 S * 5/2014 Chen D14/138 G
 D710,815 S * 8/2014 Kim D14/138 G
 D716,746 S * 11/2014 Du D14/138 G
 D717,285 S * 11/2014 Fahlgren D14/248
 D721,345 S * 1/2015 Lee D14/138 G
 D741,832 S * 10/2015 Lee D14/138 G
 D755,748 S * 5/2016 Lim D14/138 G
 D758,333 S * 6/2016 Aarras D14/138 G
 D760,206 S * 6/2016 Ryu D14/248
 D786,214 S * 5/2017 Kwon D14/138 G
 D798,851 S * 10/2017 Kim D14/248
 D815,632 S * 4/2018 Akana D14/341

D819,591 S * 6/2018 Kwon D14/138 G
 D820,833 S * 6/2018 Kim D14/341
 D831,603 S * 10/2018 Ryu D14/138 G
 D832,267 S * 10/2018 Akana D14/439
 D834,550 S * 11/2018 Ryu D14/138 G
 10,129,378 B2 * 11/2018 Nonaka H04M 1/035
 D841,633 S * 2/2019 Kim D14/248
 D841,634 S * 2/2019 Ryu D14/248
 D850,402 S * 6/2019 Cho D14/138 G
 2017/0289324 A1 * 10/2017 Yeo G03B 29/00

OTHER PUBLICATIONS

Xiaomi Mi 8 Lite, announced Sep. 2018, [online], [retrieved on Jun. 7, 2019]. Retrieved from Internet ,<URL: <http://www.gsmarena.com>>.*
 Huawei P20 lite, announced Mar. 2018, [online], [retrieved on Jun. 7, 2019]. Retrieved from Internet ,<URL: <http://www.gsmarena.com>>.*
 OnePlus 6, announced May 2018, [online], [retrieved on Jun. 7, 2019]. Retrieved from Internet ,<URL: <http://www.gsmarena.com>>.*

* cited by examiner

FIG. 1

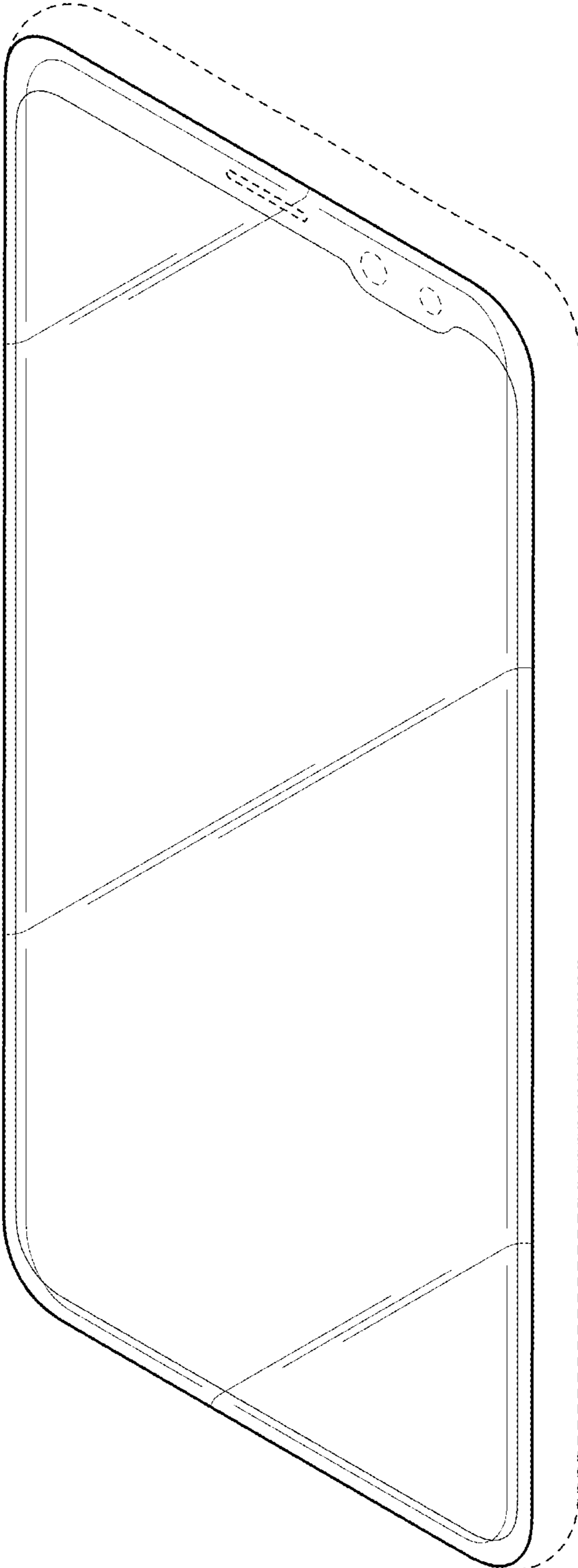

FIG.2

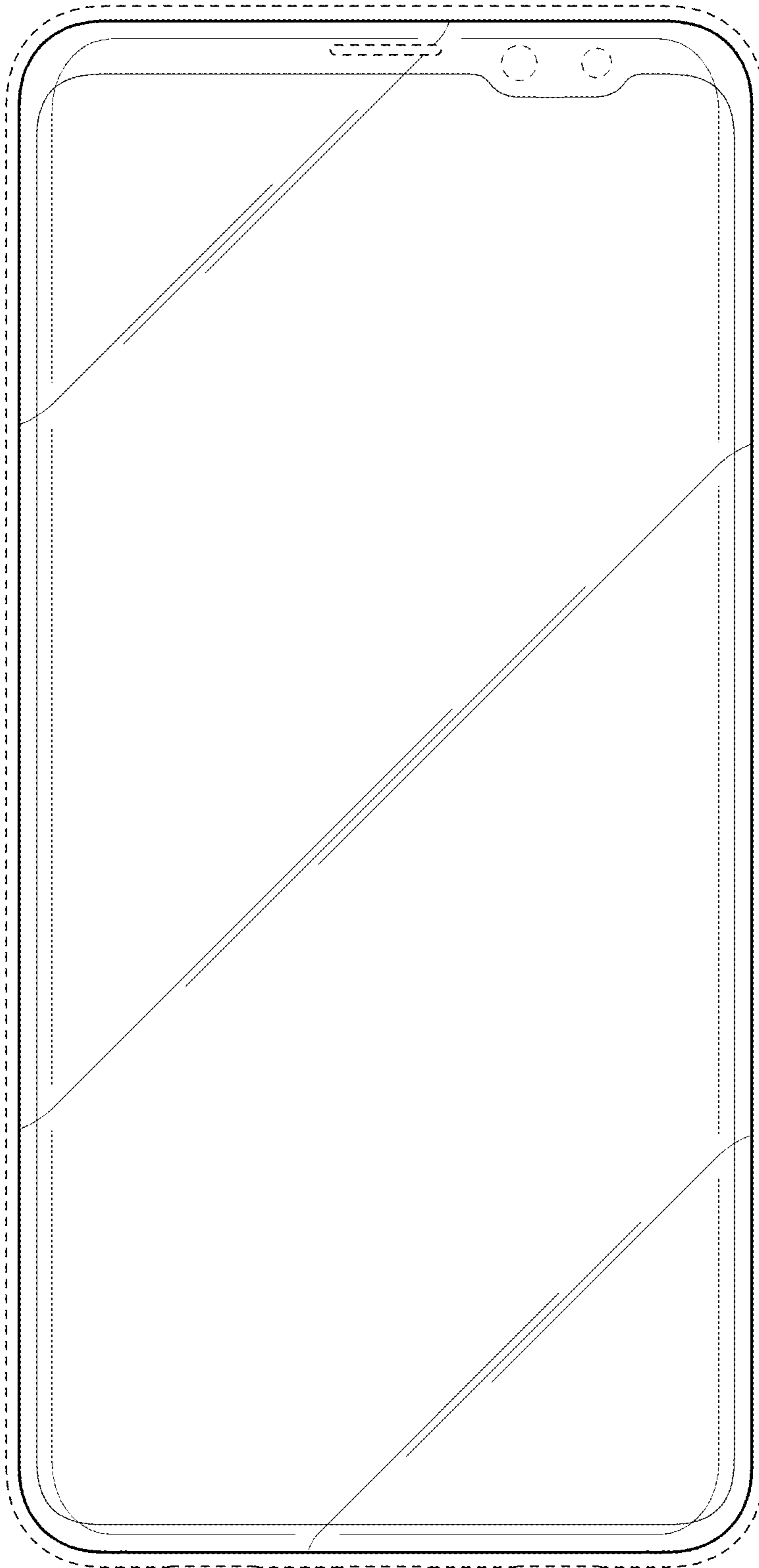

FIG.3

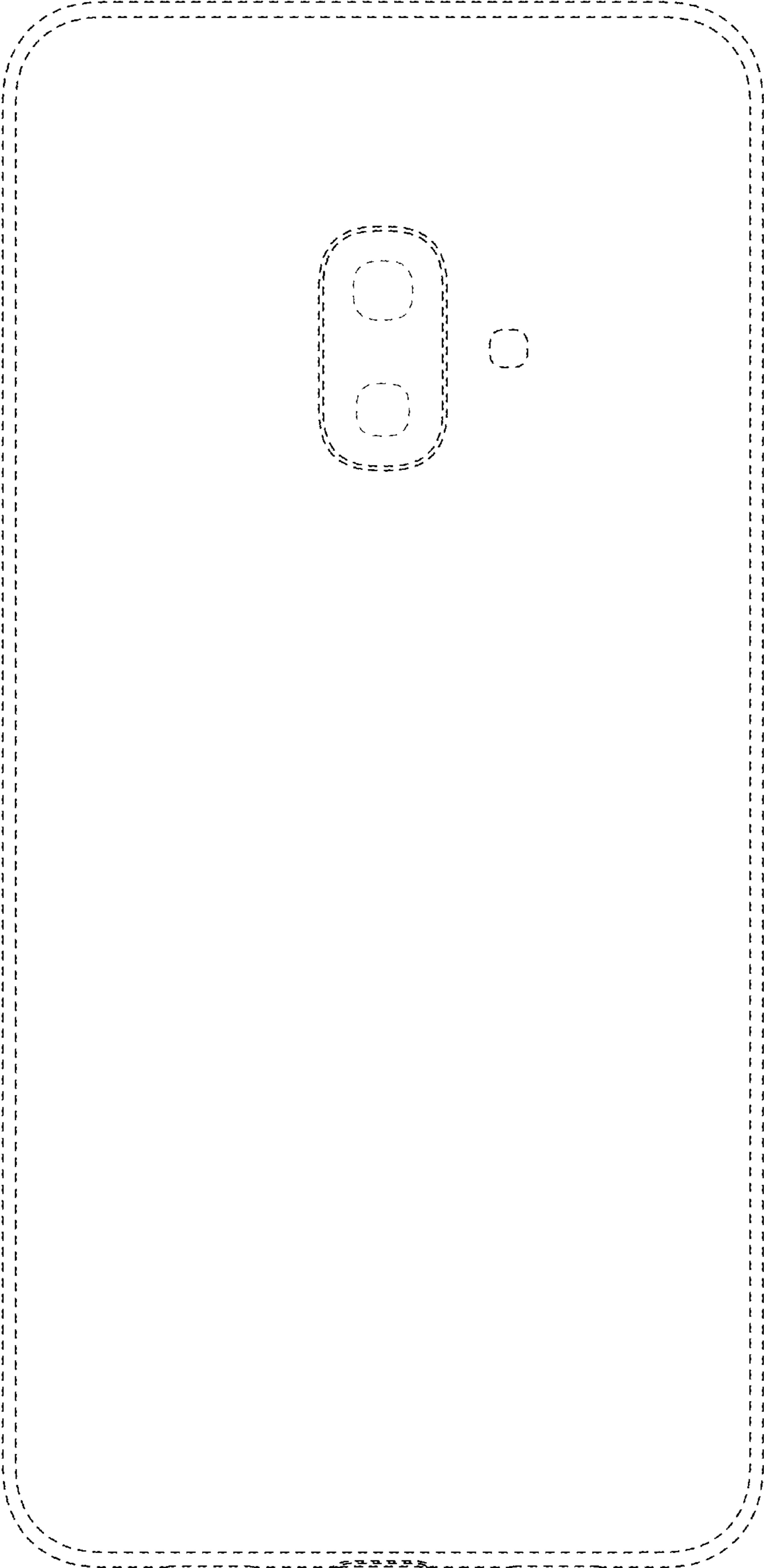

FIG.4

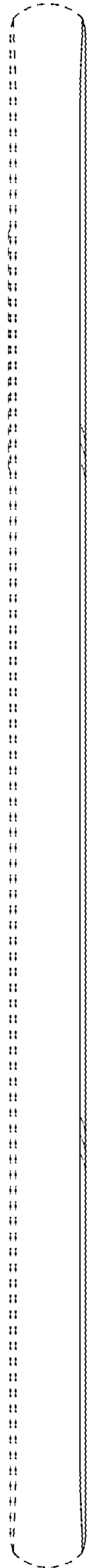

FIG.5

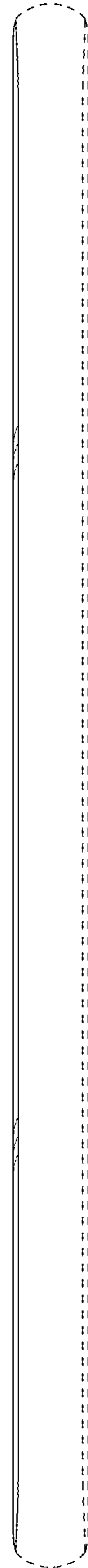

FIG.6

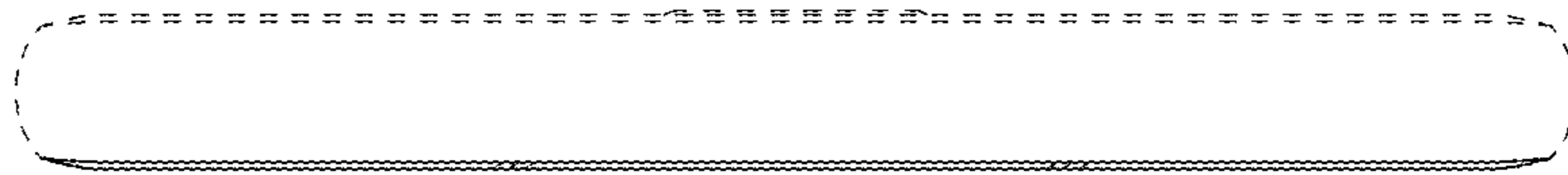

FIG.7

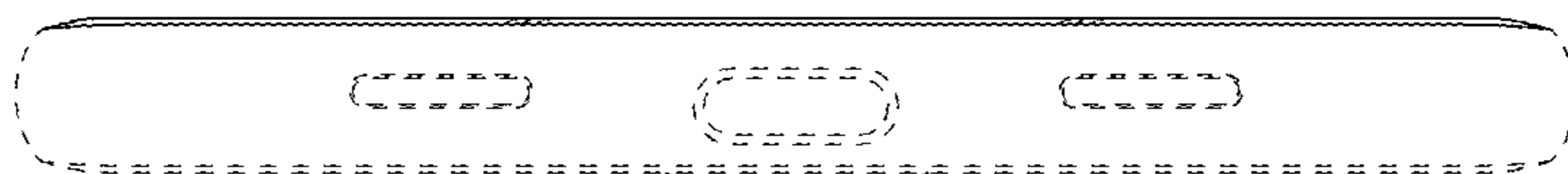

FIG.8

