



US00D873254S

(12) **United States Design Patent** (10) **Patent No.:** **US D873,254 S**
Homza et al. (45) **Date of Patent:** **** Jan. 21, 2020**

- (54) **ROUTER**
- (71) Applicant: **Comcast Cable Communications, LLC**, Philadelphia, PA (US)
- (72) Inventors: **Henry Homza**, Philadelphia, PA (US); **Michael Jou**, Philadelphia, PA (US); **Neil Epstein**, Philadelphia, PA (US)
- (73) Assignee: **Comcast Cable Communications, LLC**, Philadelphia, PA (US)
- (**) Term: **15 Years**
- (21) Appl. No.: **29/646,524**
- (22) Filed: **May 4, 2018**
- (51) **LOC (12) Cl.** **14-03**
- (52) **U.S. Cl.**
USPC **D14/242**
- (58) **Field of Classification Search**
USPC D14/240, 242, 357, 358, 125, 126, D14/140-140.9, 348, 349, 351, 354, 355
CPC H04L 12/00; H03K 17/00; H04W 88/00; H04W 88/005; H04W 88/02; H04W 88/08; H04W 88/085; H04W 88/10; H04W 88/12; H04W 88/14; H04B 1/38
See application file for complete search history.

(56) **References Cited**

U.S. PATENT DOCUMENTS

D464,958 S	10/2002	Coker et al.	
D471,541 S	3/2003	Tomino et al.	
D480,390 S	10/2003	Miao et al.	
D486,479 S *	2/2004	Chung	D14/240
D489,720 S	5/2004	Sasaki	
D493,780 S	8/2004	Chan et al.	
D529,904 S *	10/2006	Yeo	D14/240
D548,731 S	8/2007	Liu et al.	
D594,864 S	6/2009	Song	

D598,436 S * 8/2009 Tseng D14/240
D604,725 S 11/2009 Chen
D611,040 S 3/2010 Neu et al.
(Continued)

Primary Examiner — Bridget L Eland
(74) *Attorney, Agent, or Firm* — Banner & Witcoff, Ltd.

(57) **CLAIM**

The ornamental design for a router, as shown and described.

DESCRIPTION

FIG. 1 is a front perspective view of a first embodiment of a router showing our new design;
FIG. 2 is a front view thereof;
FIG. 3 is a rear view thereof;
FIG. 4 is a right side view thereof;
FIG. 5 is a left side view thereof;
FIG. 6 is a top view thereof;
FIG. 7 is a bottom view thereof;
FIG. 8 is the front perspective view of FIG. 1 disclosing an encircled portion thereof;
FIG. 9 is a front perspective view of a second embodiment of a router showing our new design;
FIG. 10 is a front view thereof;
FIG. 11 is a rear view thereof;
FIG. 12 is a right side view thereof;
FIG. 13 is a left side view thereof;
FIG. 14 is a top view thereof;
FIG. 15 is a bottom view thereof; and,
FIG. 16 is the front perspective view of FIG. 9 disclosing an encircled portion thereof.

The broken lines immediately adjacent to the shaded areas represent the bounds of the claimed design and form no part thereof. All other broken lines are directed to environment and are for illustrative purposes only and form no part of the claimed design. The dot-dash lines in FIGS. 1, 8, 9, and 16 are imaginary lines that are included for reference purposes only to identify the partially enlarged views; the dot-dash lines form no part of the claimed design.

1 Claim, 16 Drawing Sheets

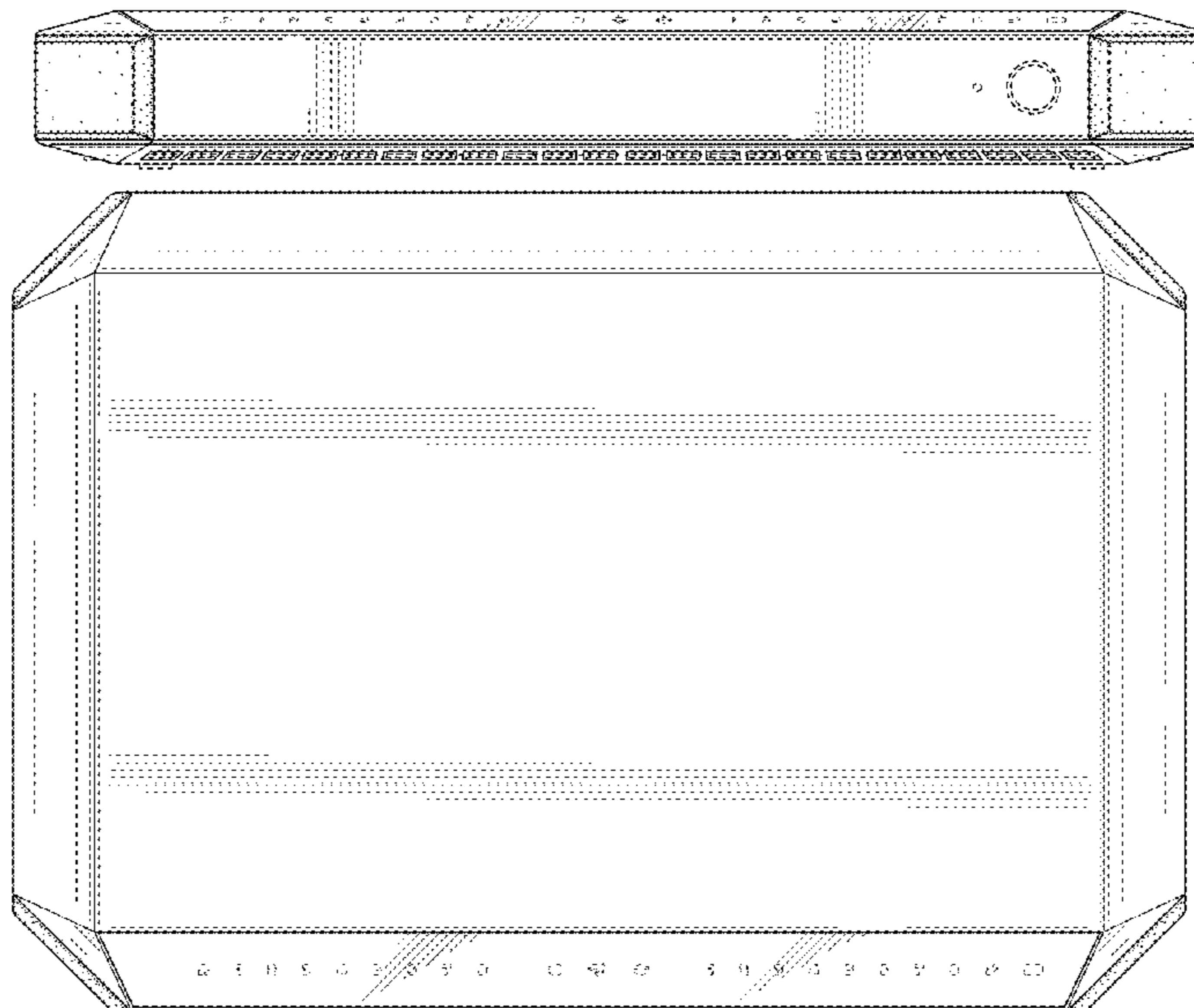

(56)

References Cited

U.S. PATENT DOCUMENTS

D620,485 S	7/2010	Corrigan et al.	
D630,632 S	1/2011	Puls et al.	
D644,221 S	8/2011	Kemery et al.	
D664,143 S	7/2012	Chaturvedi et al.	
D670,277 S	11/2012	Huang	
D686,201 S *	7/2013	Lee	D14/314
D707,667 S	6/2014	Kono et al.	
D710,341 S *	8/2014	Cheng	D14/240
D719,939 S	12/2014	Liang et al.	
D725,624 S *	3/2015	Carney	D14/140
D729,216 S	5/2015	Peng et al.	
D730,893 S	6/2015	Yin et al.	
D732,010 S	6/2015	Hsiau	
D745,865 S	12/2015	Hsu	
D783,610 S *	4/2017	Zhou	D14/240
D784,328 S *	4/2017	Zhou	D14/240
D794,020 S *	8/2017	Homza	D14/240
D808,963 S *	1/2018	Delpier	D14/348
D809,492 S *	2/2018	Moon	D14/240
D811,377 S *	2/2018	Wang	D14/240
D832,837 S *	11/2018	Pennington, Jr.	D14/348

* cited by examiner

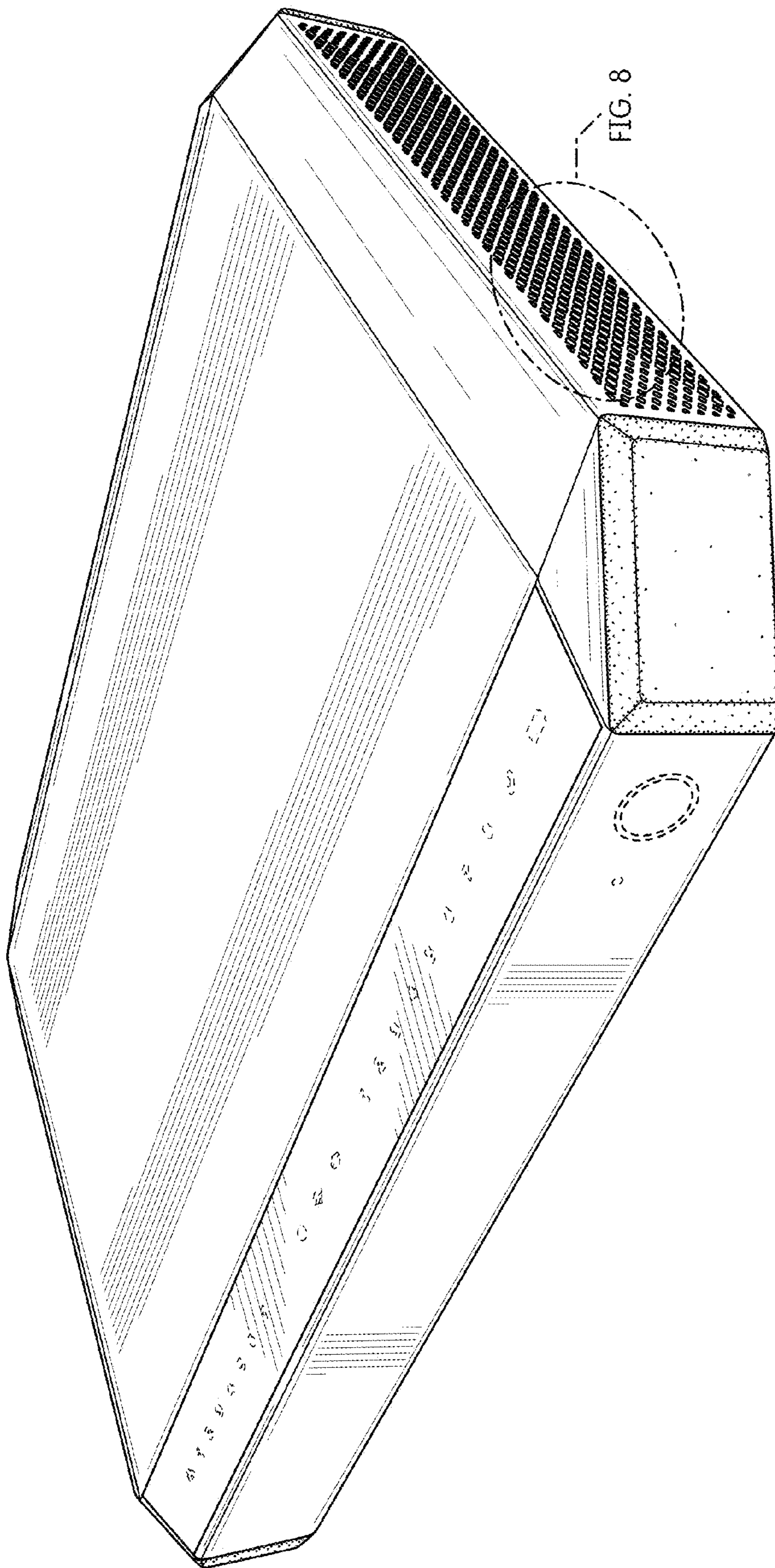

FIG. 1

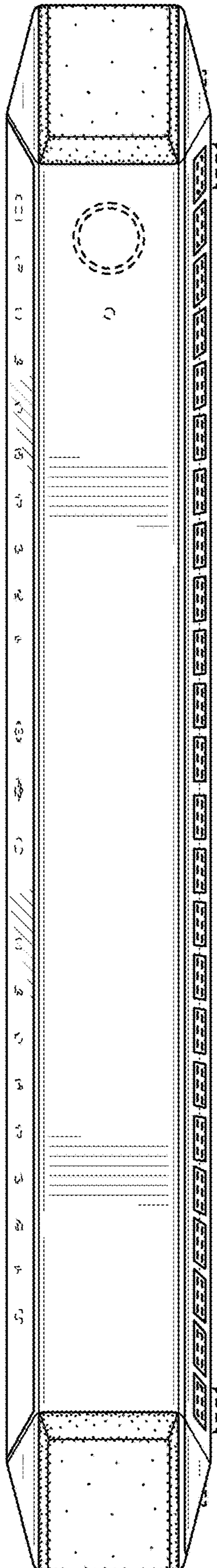

FIG. 2

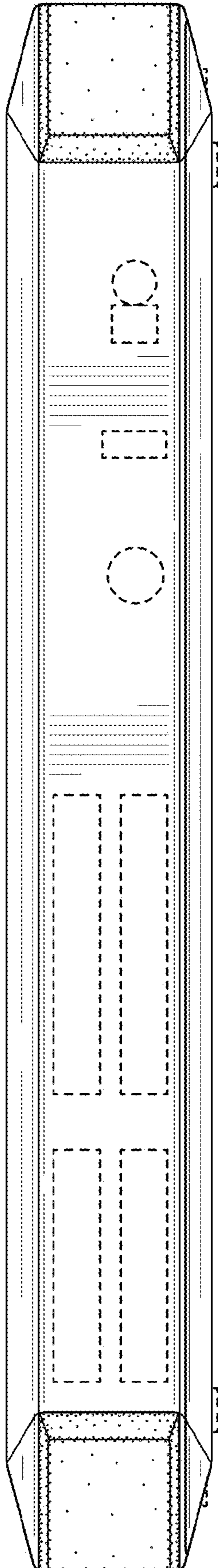

FIG. 3

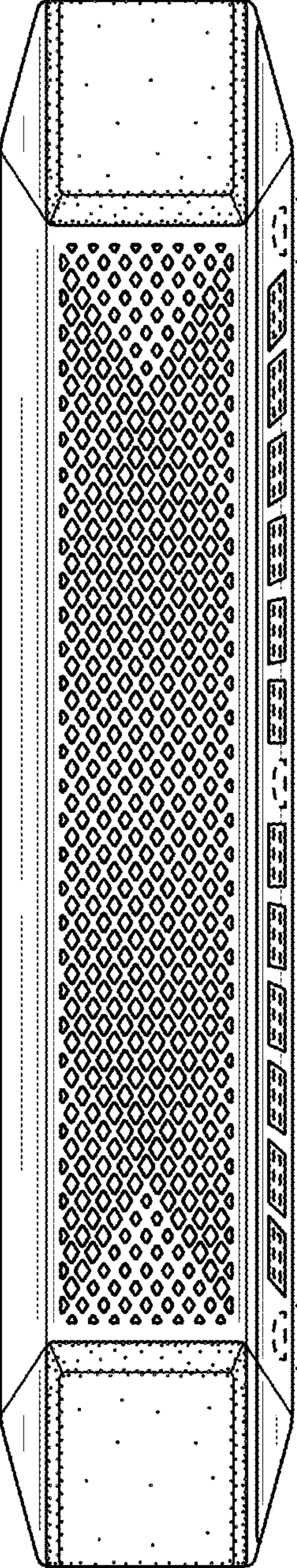

FIG. 4

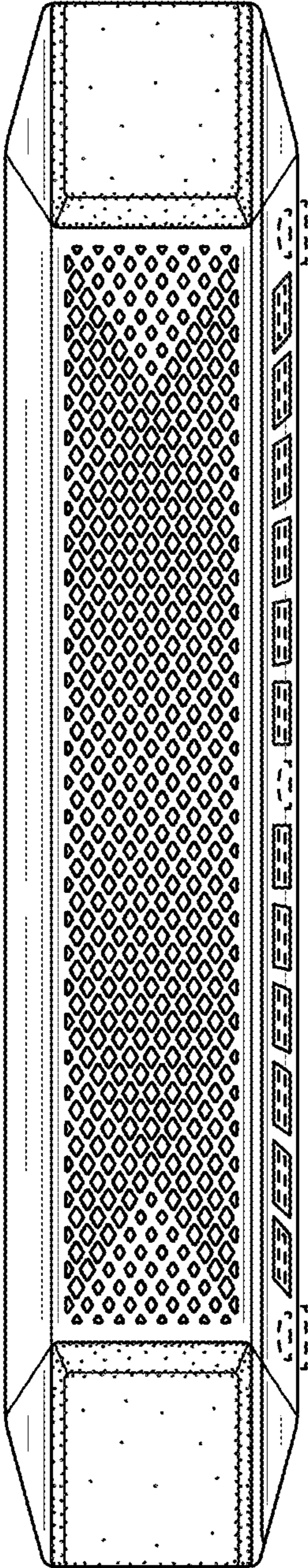

FIG. 5

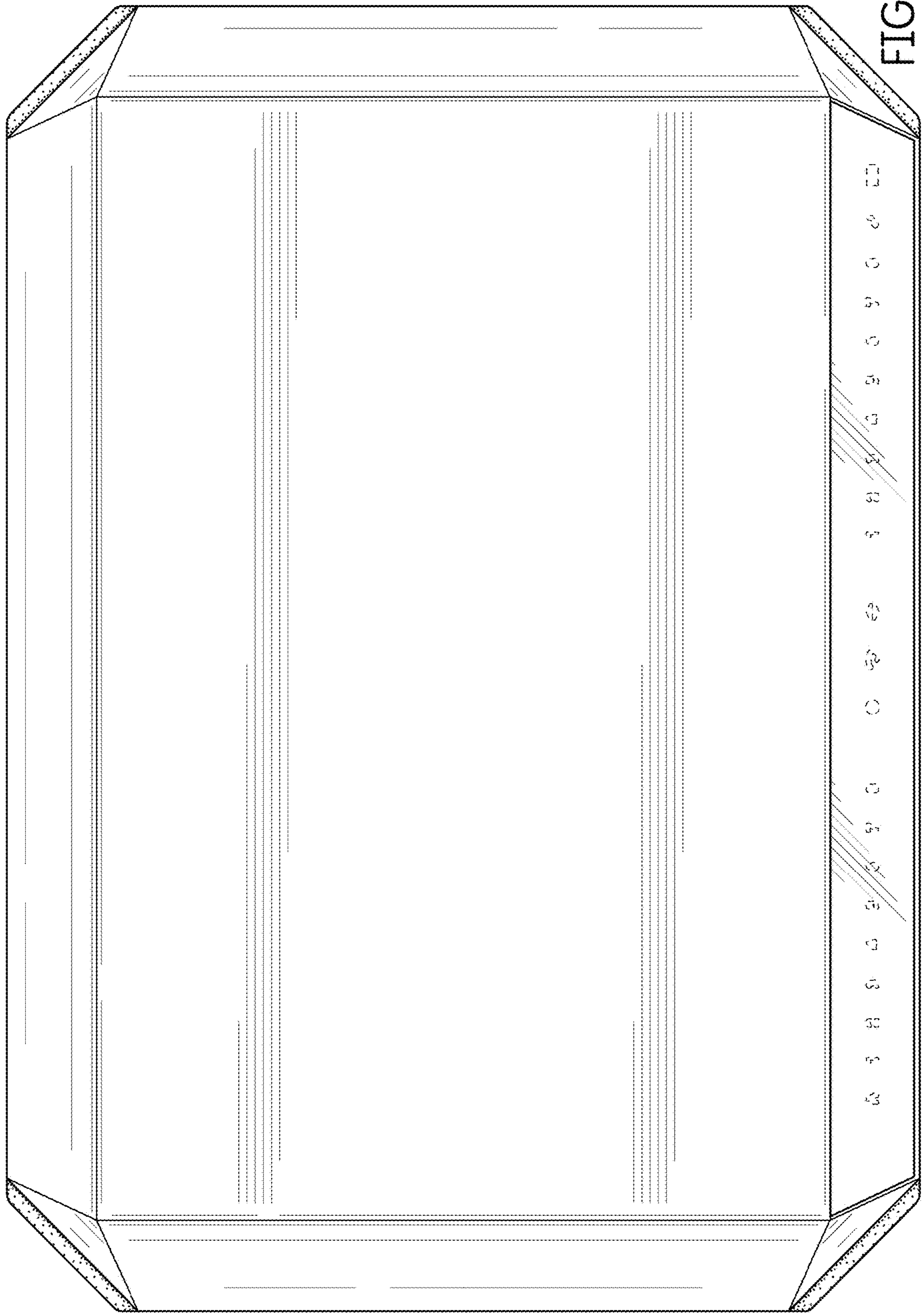

FIG. 6

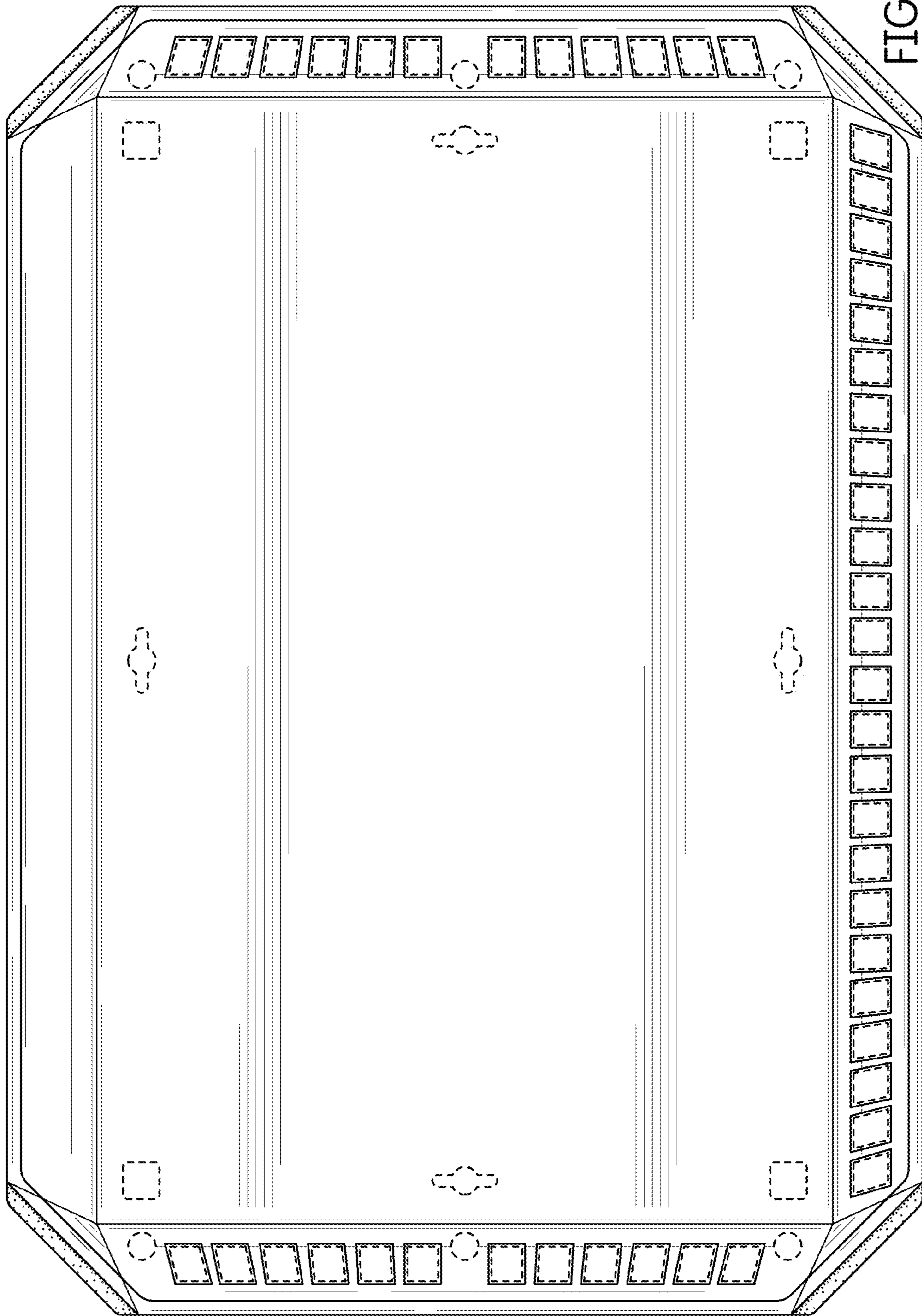

FIG. 7

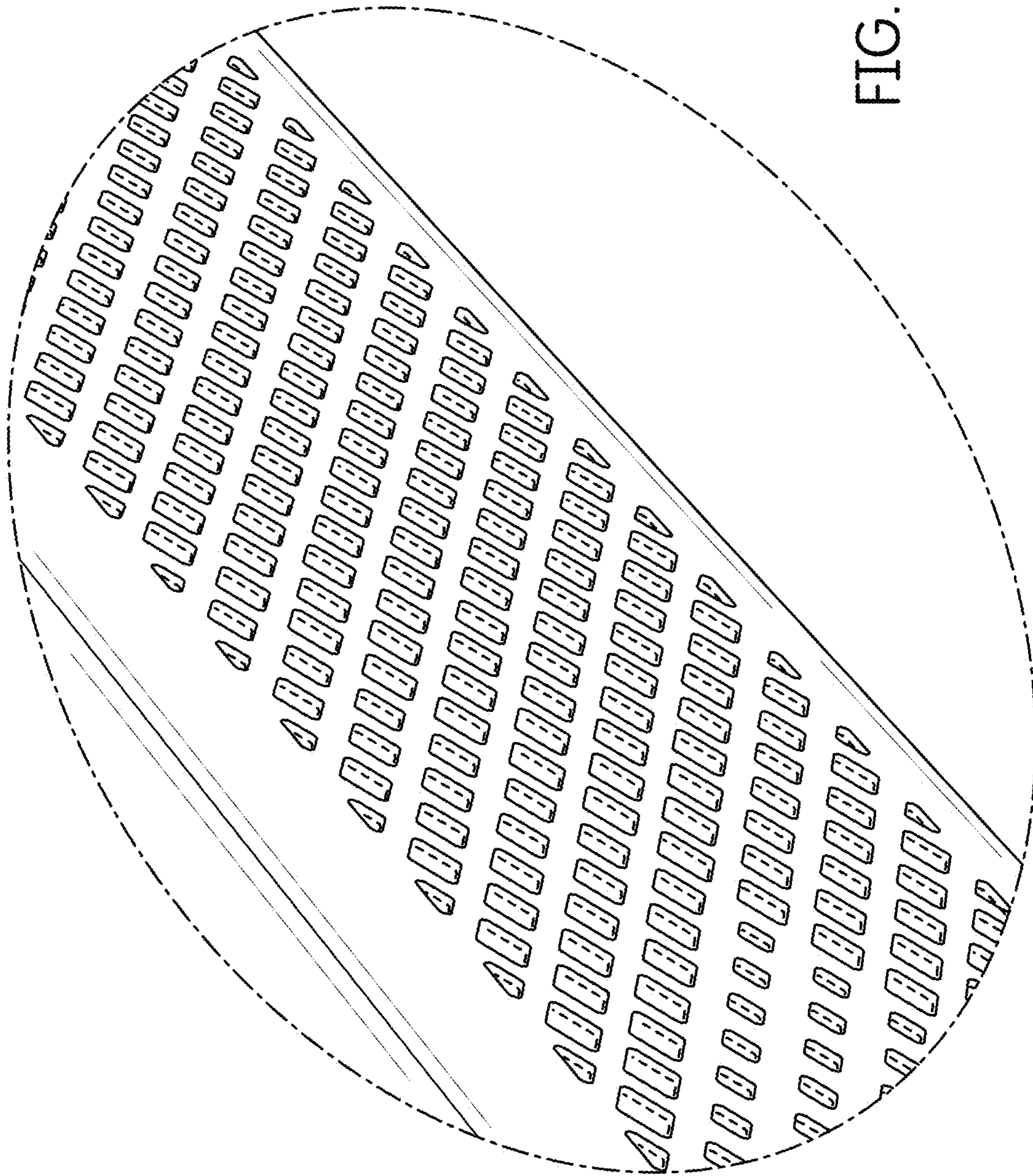

FIG. 8

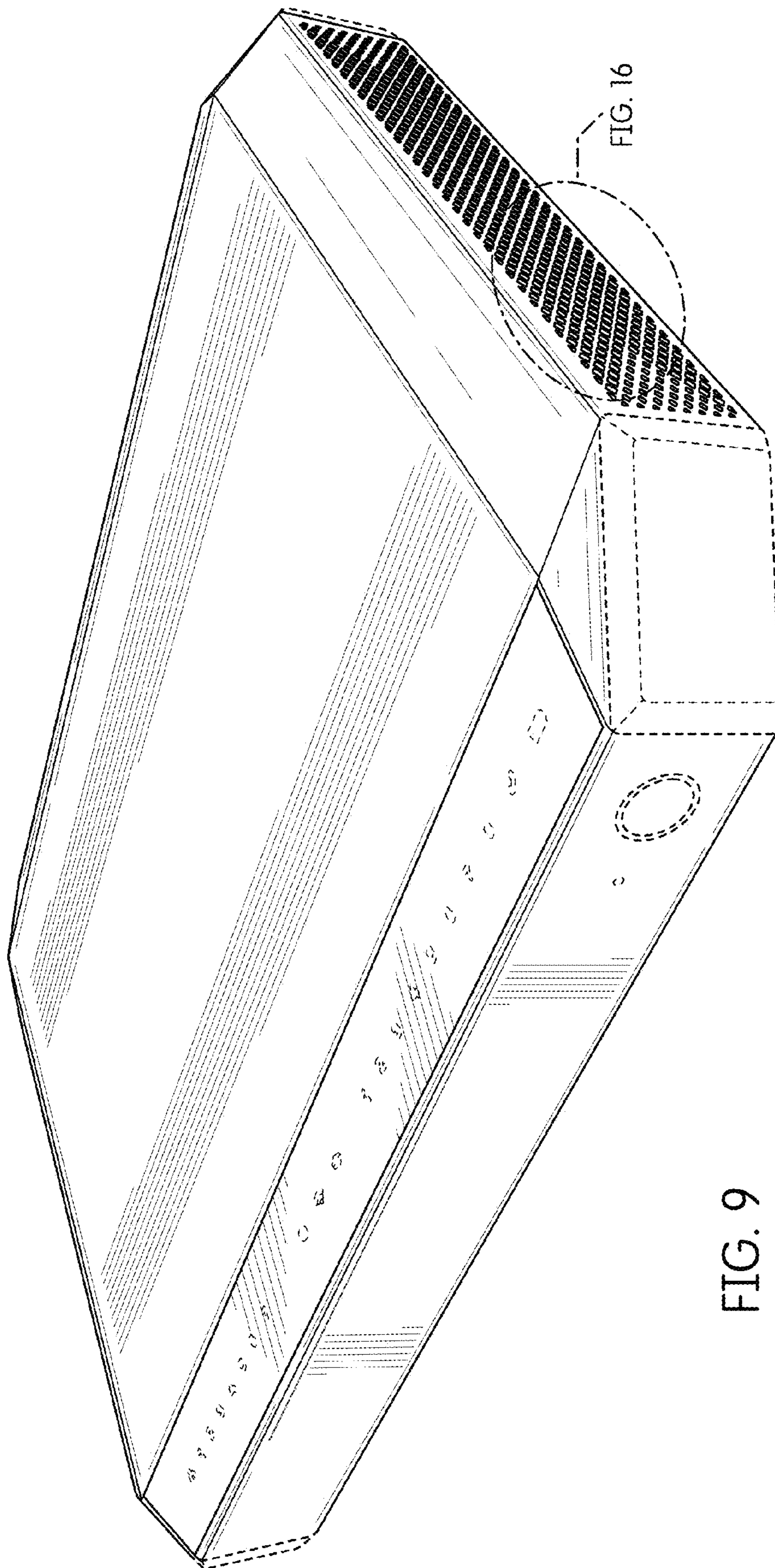

FIG. 16

FIG. 9

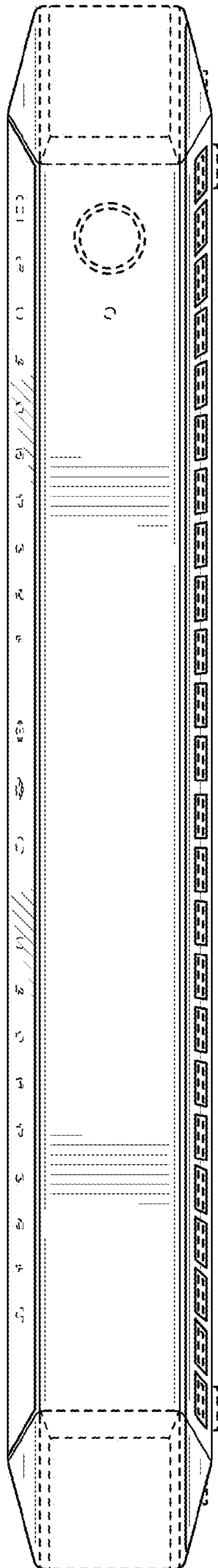

FIG. 10

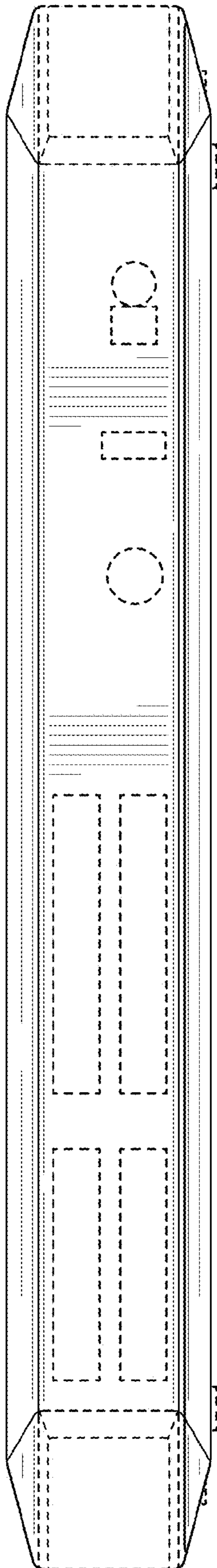

FIG. 11

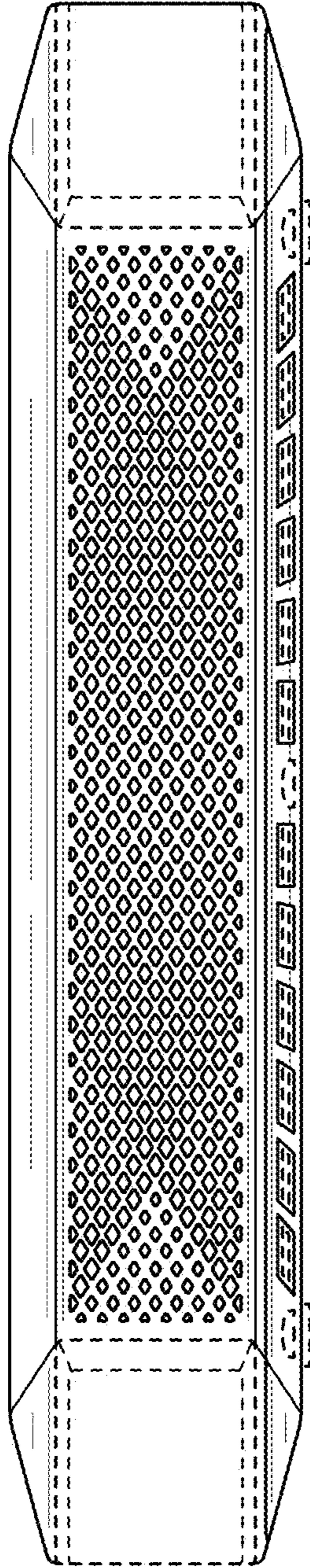

FIG. 12

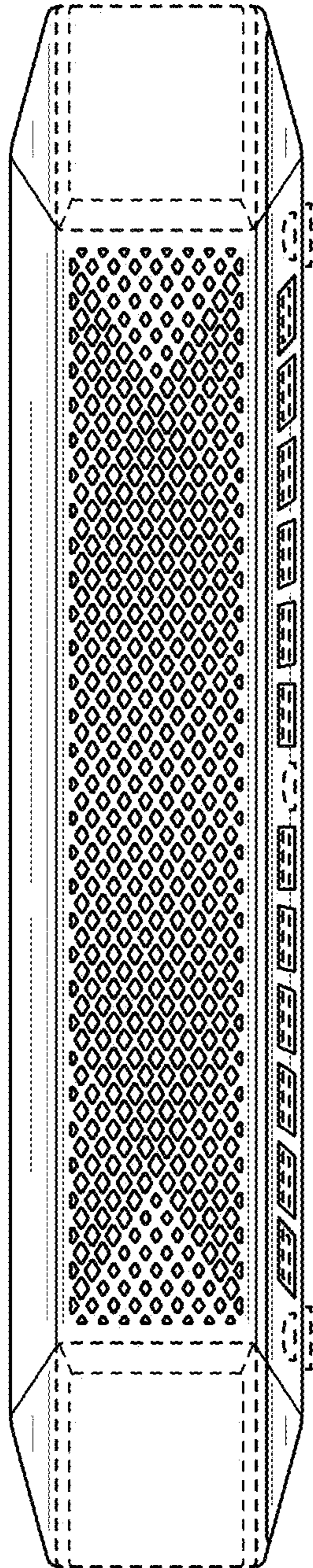

FIG. 13

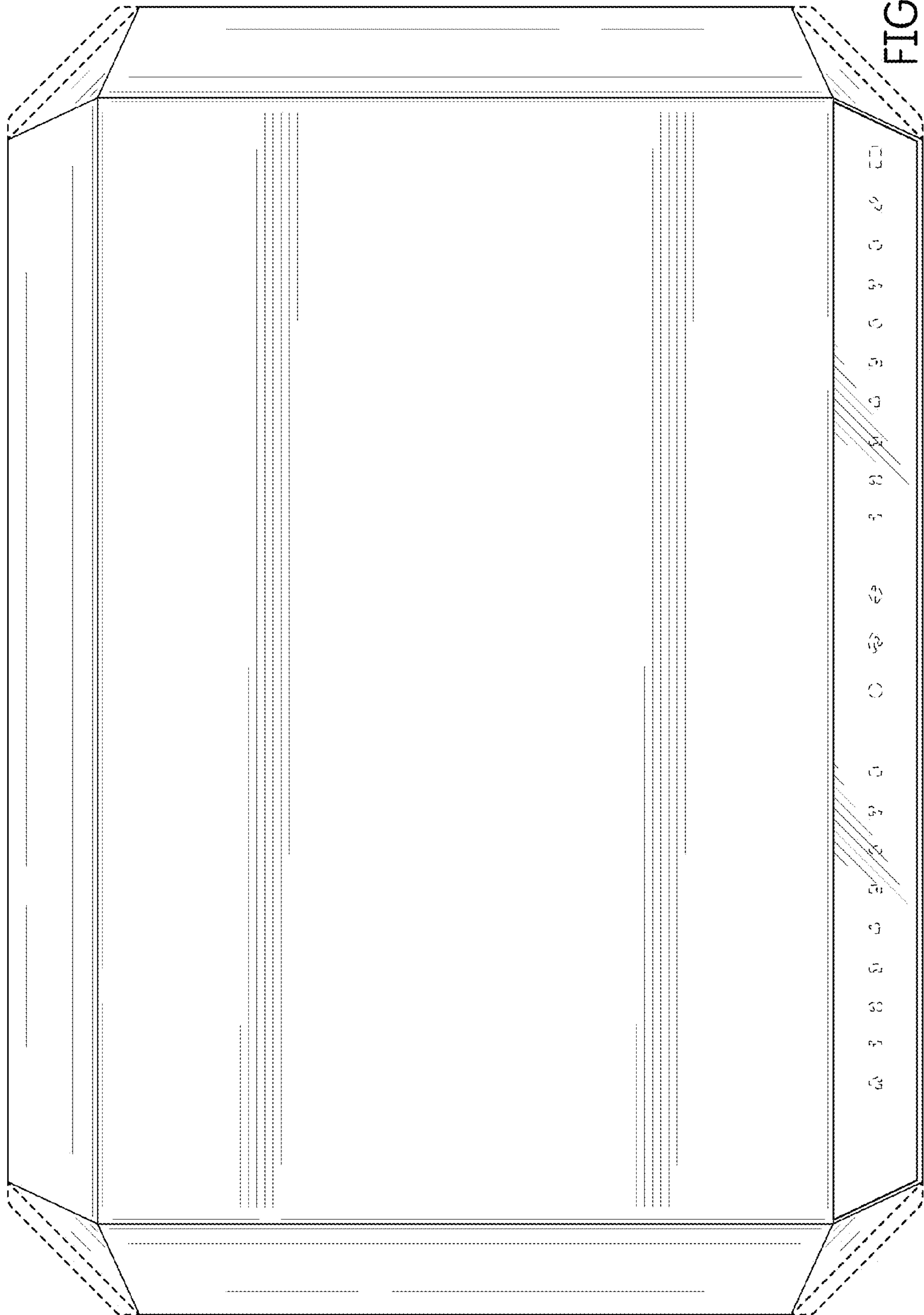

FIG. 14

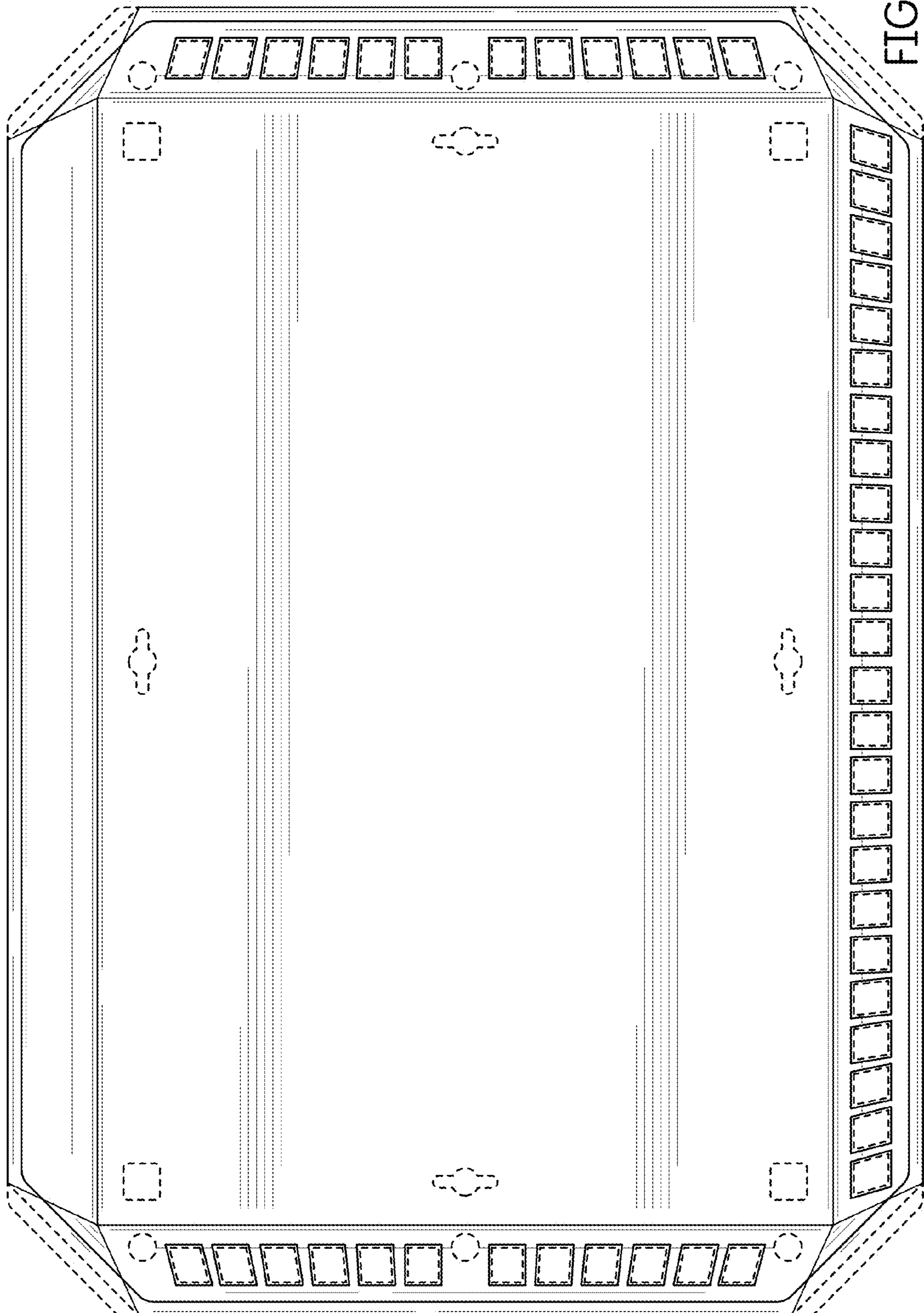

FIG. 15

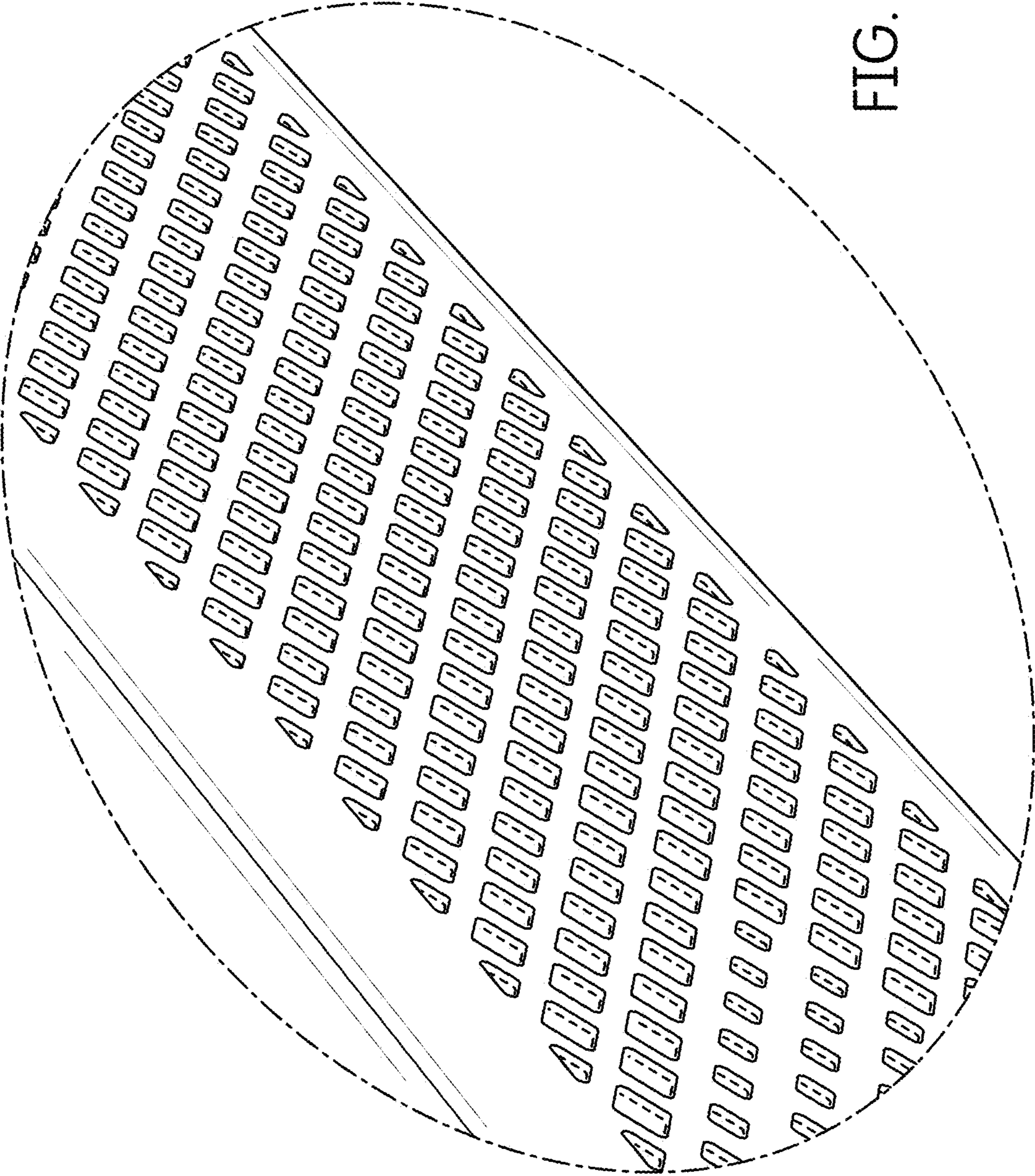

FIG. 16