



US00D873228S

(12) **United States Design Patent**
Krivosnak et al.

(10) **Patent No.:** **US D873,228 S**
(45) **Date of Patent:** **** Jan. 21, 2020**

(54) **ELECTRONICS ENCLOSURE**
(71) Applicant: **Transportation IP Holdings, LLC**,
Norwalk, CT (US)
(72) Inventors: **Andrew Louis Krivosnak**, Erie, PA
(US); **Shreenath Shekar Perlaguri**,
Bangalore (IN); **Brian Magann Rush**,
Niskayuna, NY (US); **Rajendra**
Yammanuru, Bangalore (IN); **Michael**
Grutkowski, Erie, PA (US); **Naveenan**
Thiagarajan, Latham, NY (US);
Arunpandi Radhakrishnan, Bangalore
(IN)

(73) Assignee: **Transportation Holdings, LLC**,
Norwalk, CT (US)

(**) Term: **15 Years**

(21) Appl. No.: **29/574,118**

(22) Filed: **Aug. 12, 2016**

(51) **LOC (12) Cl.** **13-03**

(52) **U.S. Cl.**
USPC **D13/184**

(58) **Field of Classification Search**
USPC D13/123, 158, 162, 184, 199, 110, 124,
D13/137.1
CPC . G06F 1/20; G06F 1/181; G06F 1/187; G06F
1/183; G06F 1/184; G06F 1/16; H05K
7/16; H05K 7/1424; H05K 7/1409; H05K
7/20; H05K 7/20545; H05K 7/20727;
H05K 7/1425

See application file for complete search history.

(56) **References Cited**

U.S. PATENT DOCUMENTS

D465,465 S * 11/2002 Chapman D13/184
D747,683 S * 1/2016 Krivosnak D13/110
D777,665 S * 1/2017 Krivosnak D13/110

D777,666 S * 1/2017 Krivosnak D13/110
D802,582 S 11/2017 Krivosnak et al.
D805,473 S * 12/2017 Montgomery D13/110
D843,996 S * 3/2019 Krivosnak D14/300
D853,331 S * 7/2019 Bradley D13/122
D854,499 S * 7/2019 Lilja D13/123
2007/0081306 A1* 4/2007 Wong G06F 1/20
361/695
2017/0112018 A1 4/2017 Krivosnak et al.
2017/0112020 A1* 4/2017 Krivosnak B23K 1/00
2018/0049307 A1* 2/2018 de Bock H05K 1/0203

OTHER PUBLICATIONS

Design U.S. Appl. No. 29/614,800, filed Aug. 23, 2017 (divisional
of U.S. Pat. No. D. 802,582 noted above).

* cited by examiner

Primary Examiner — Janice Hallmark

Assistant Examiner — Harold E Blackwell, II

(74) *Attorney, Agent, or Firm* — McCoy Russell LLP

(57) **CLAIM**

The ornamental design for an electronics enclosure, as
shown and described.

DESCRIPTION

FIG. 1 is a perspective view of an electronics enclosure
depicting a new design;
FIG. 2 is a front view thereof;
FIG. 3 is a back view thereof;
FIG. 4 is a side view thereof;
FIG. 5 is an opposite side view thereof;
FIG. 6 is a top plan view thereof;
FIG. 7 is a bottom plan view thereof; and,
FIG. 8 is an additional perspective view thereof.
The broken line portion of the figure drawings is included to
show unclaimed subject matter only and forms no part of the
claimed design.

1 Claim, 8 Drawing Sheets

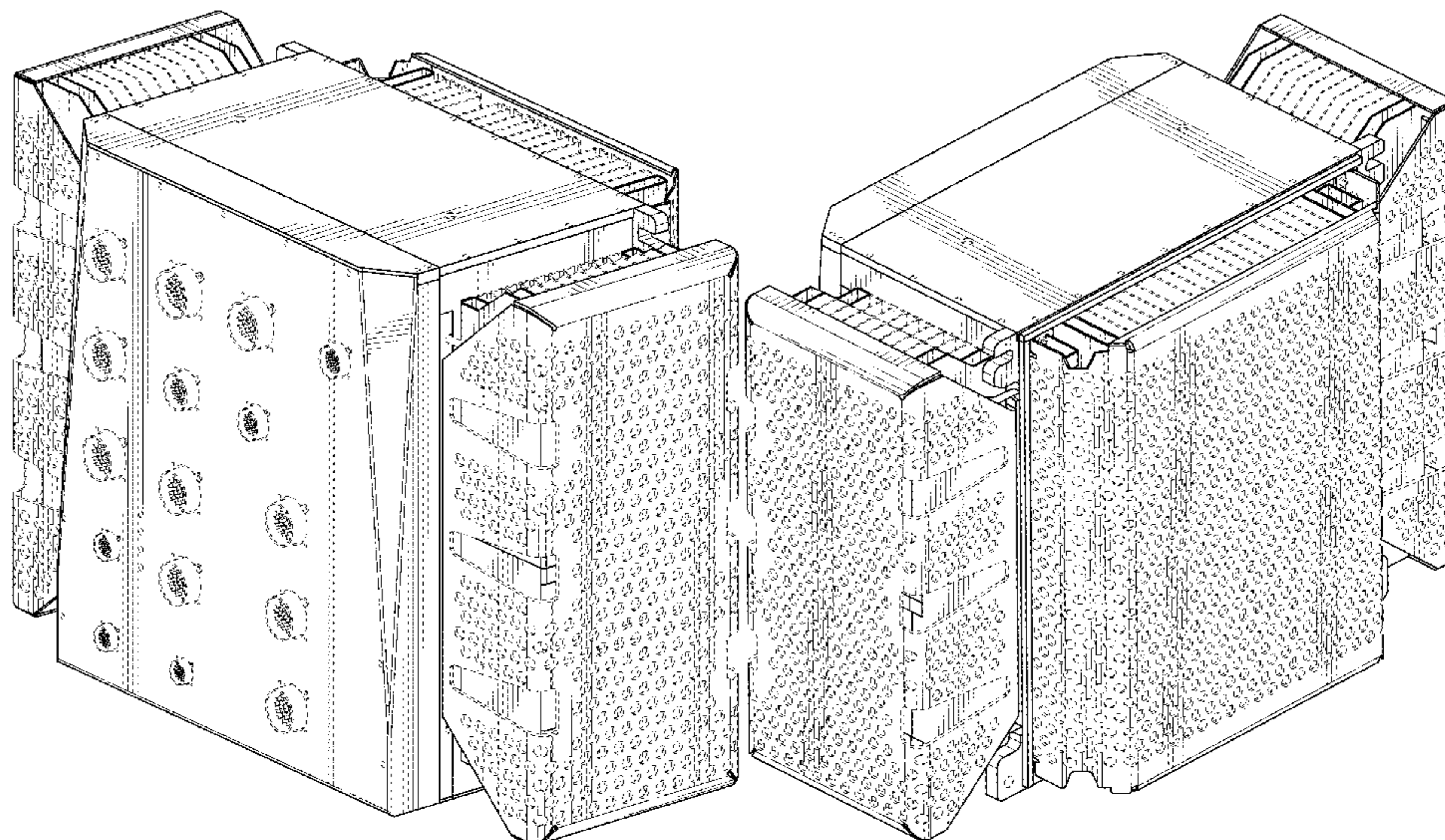

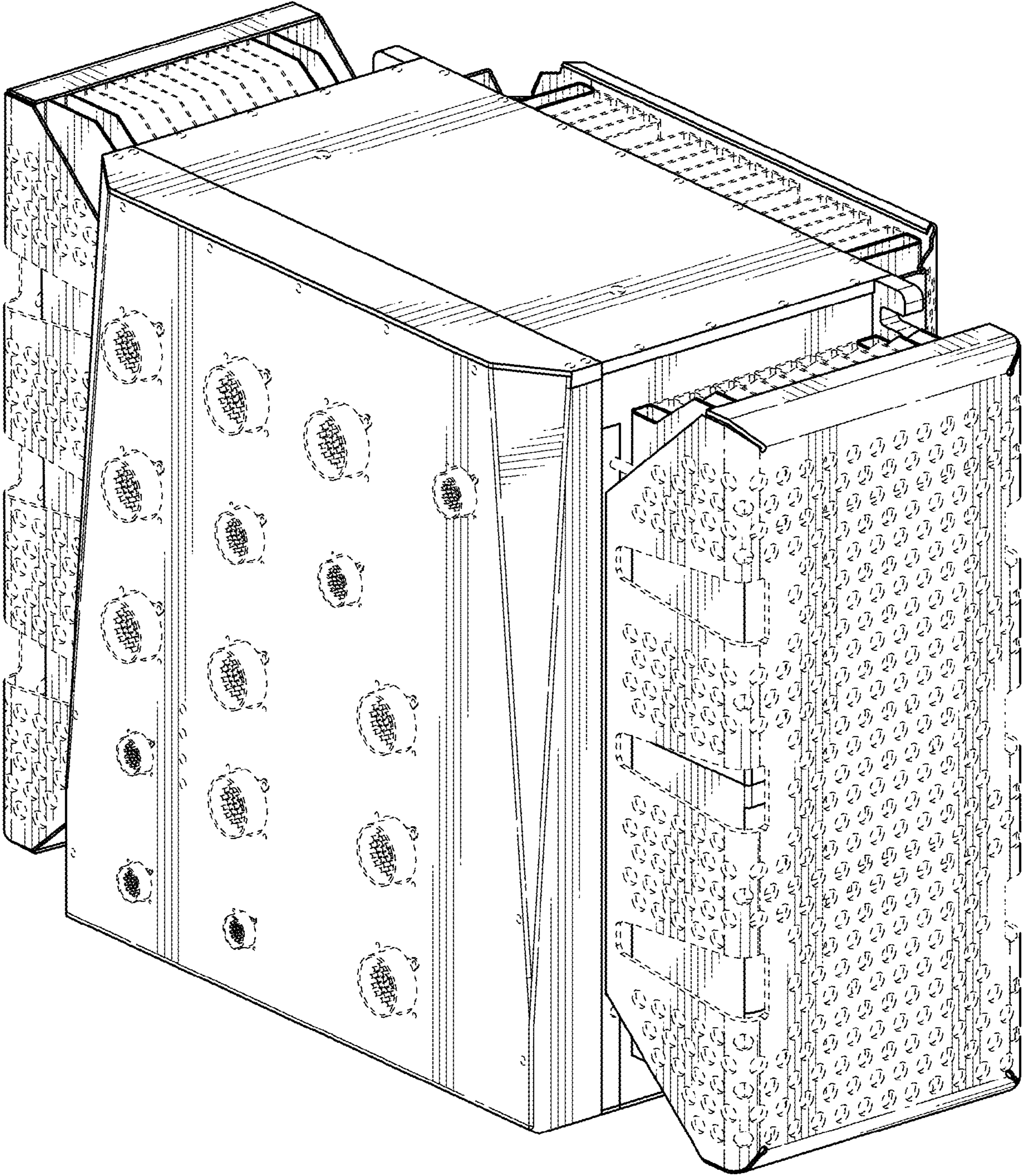

FIG. 1

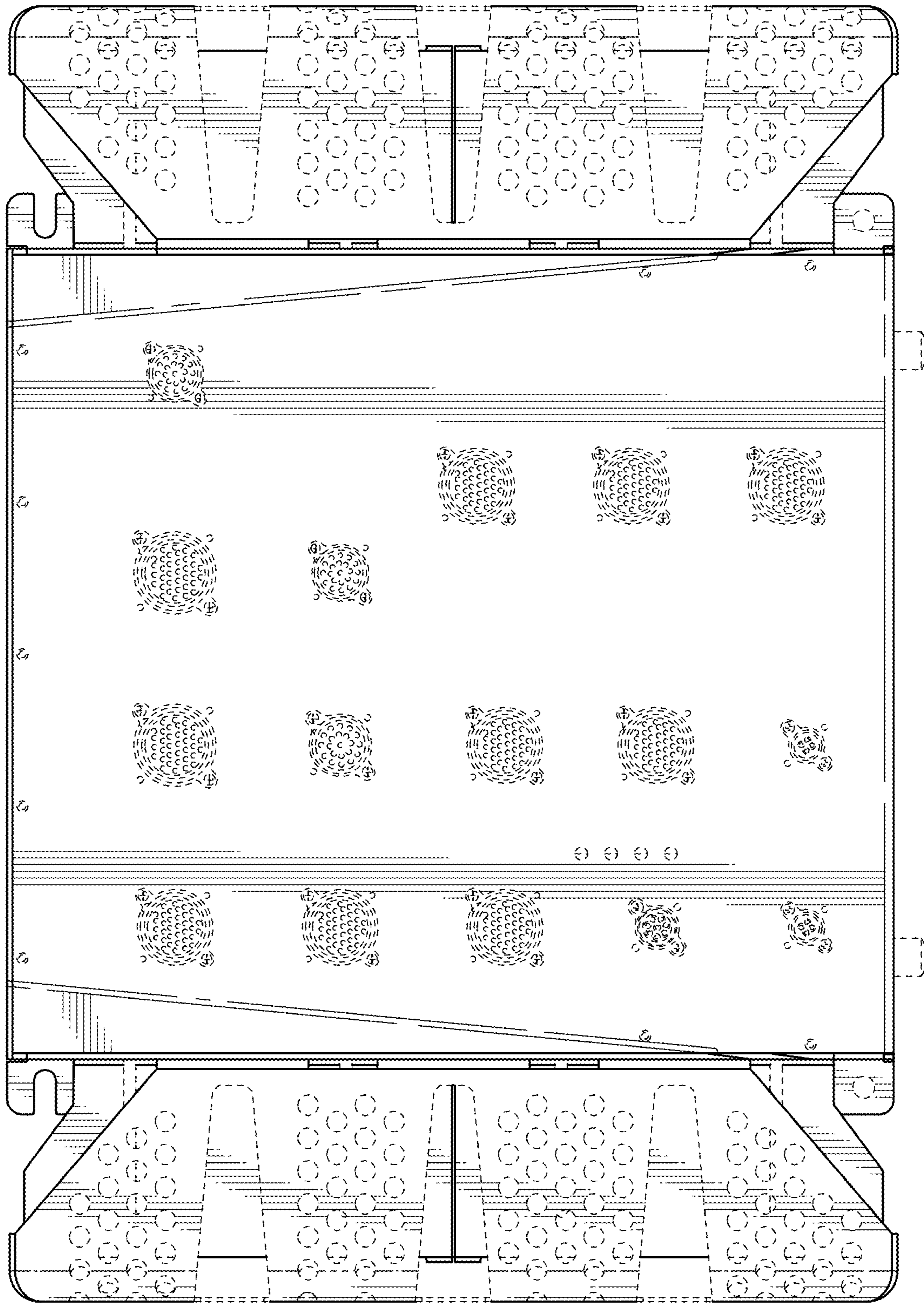

FIG. 2

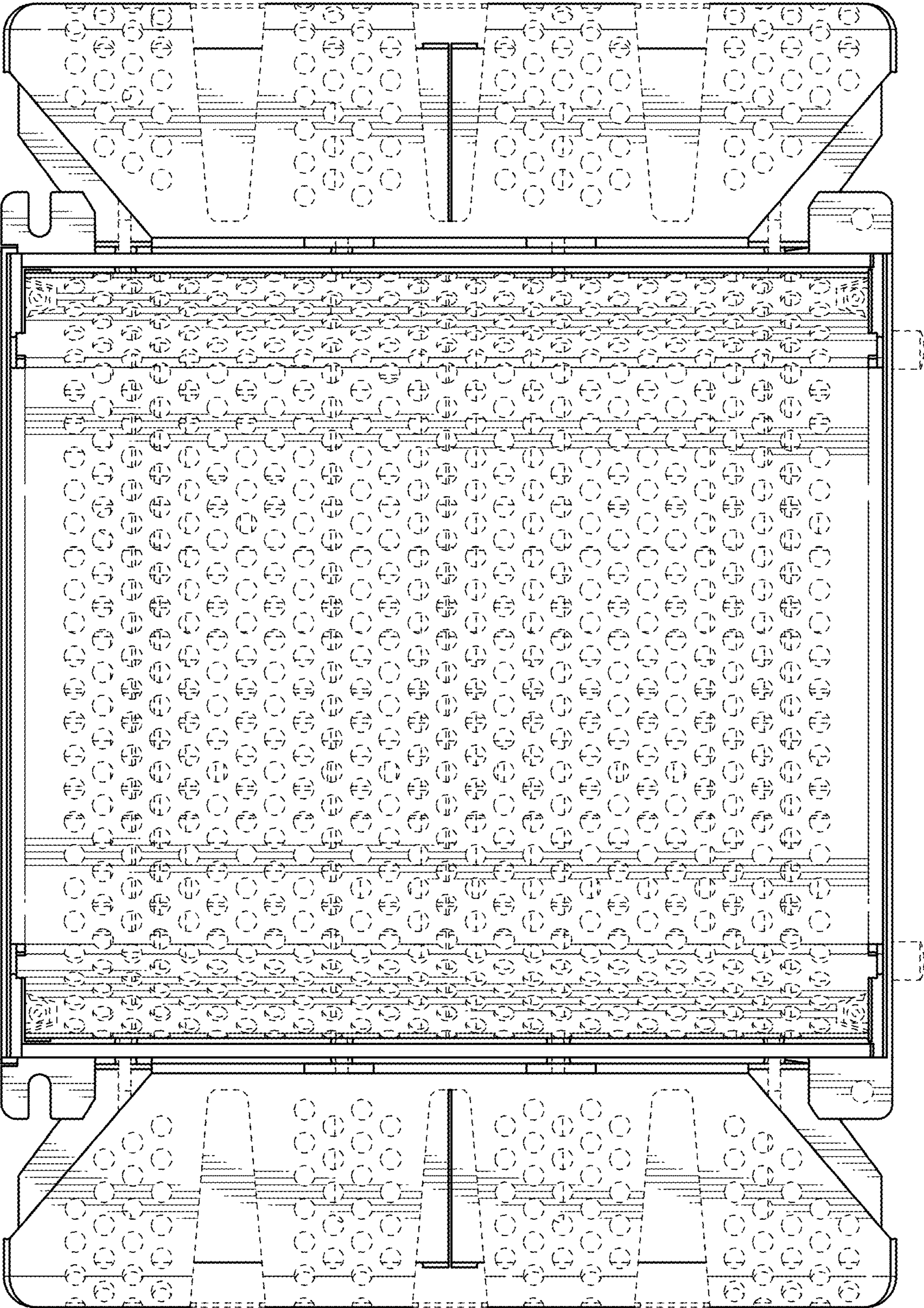

FIG. 3

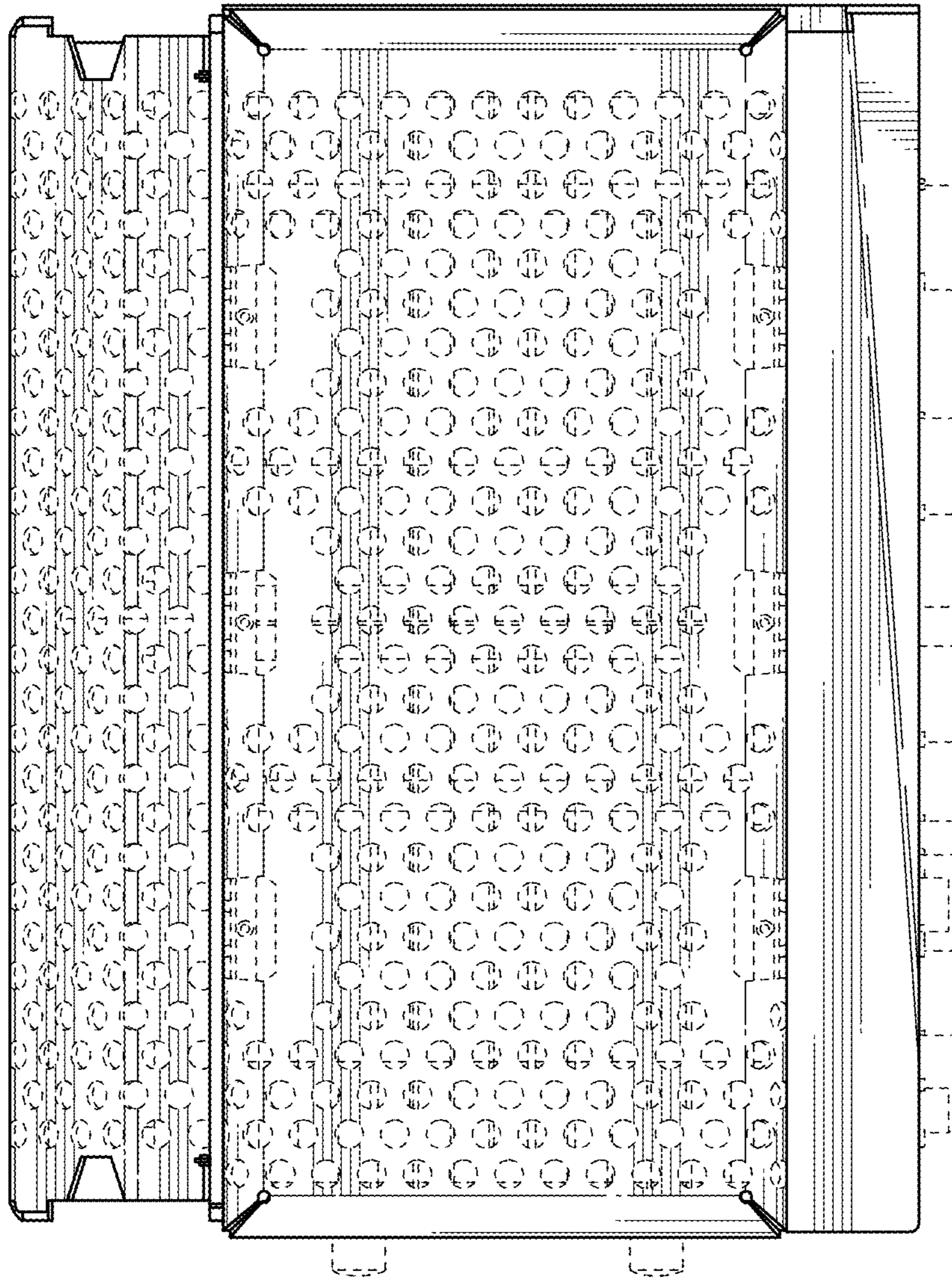

FIG. 4

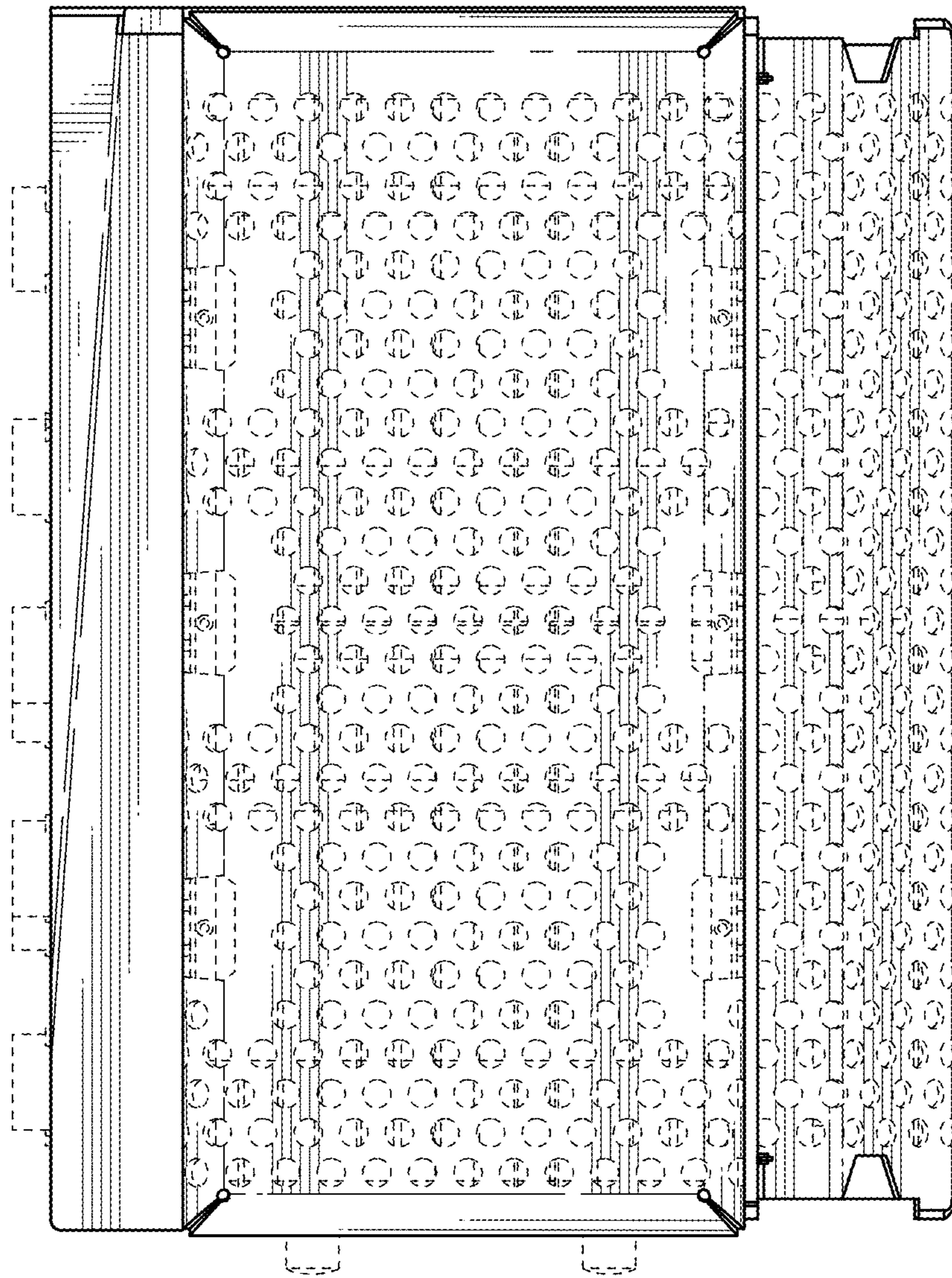

FIG. 5

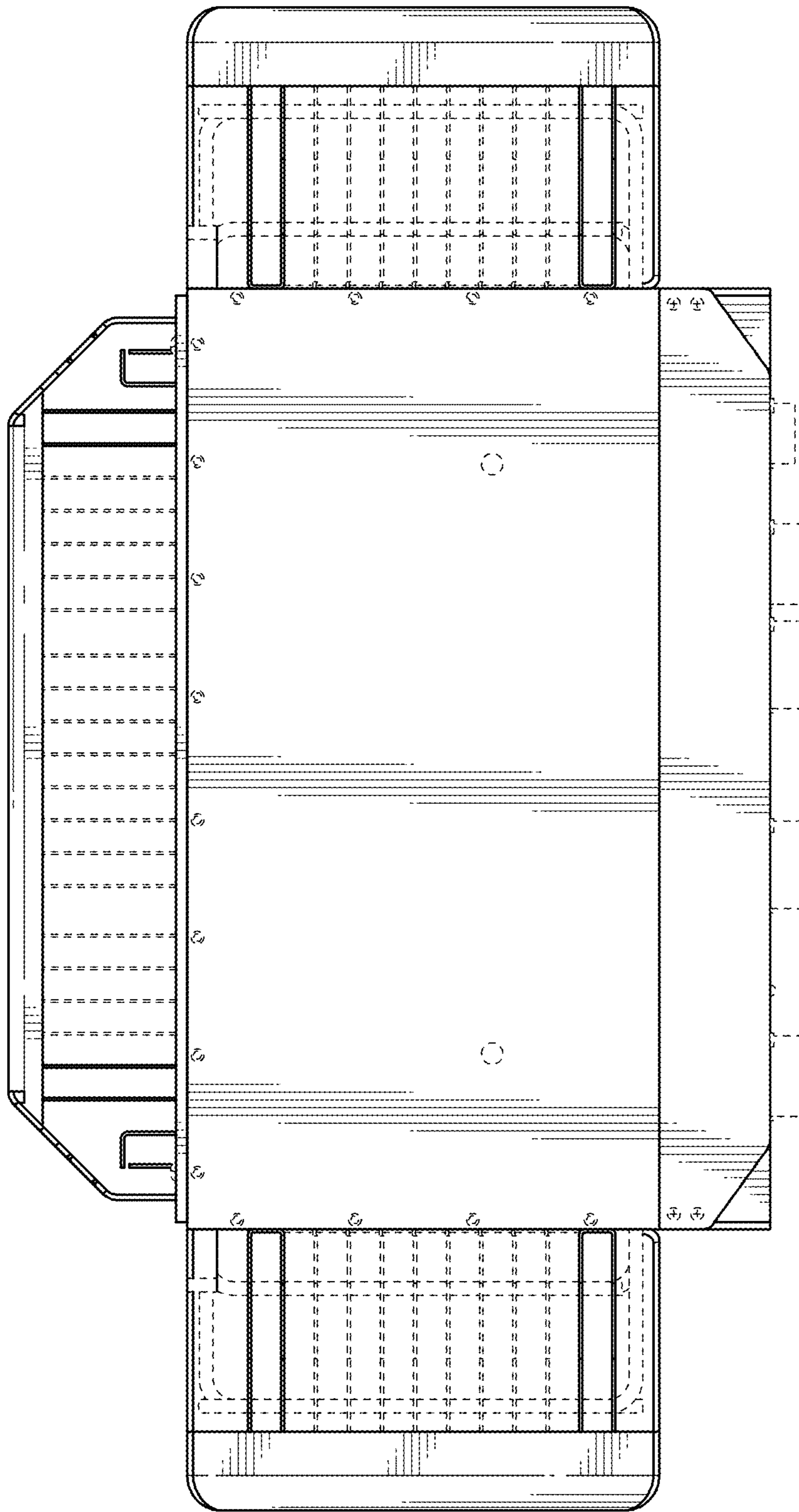

FIG. 6

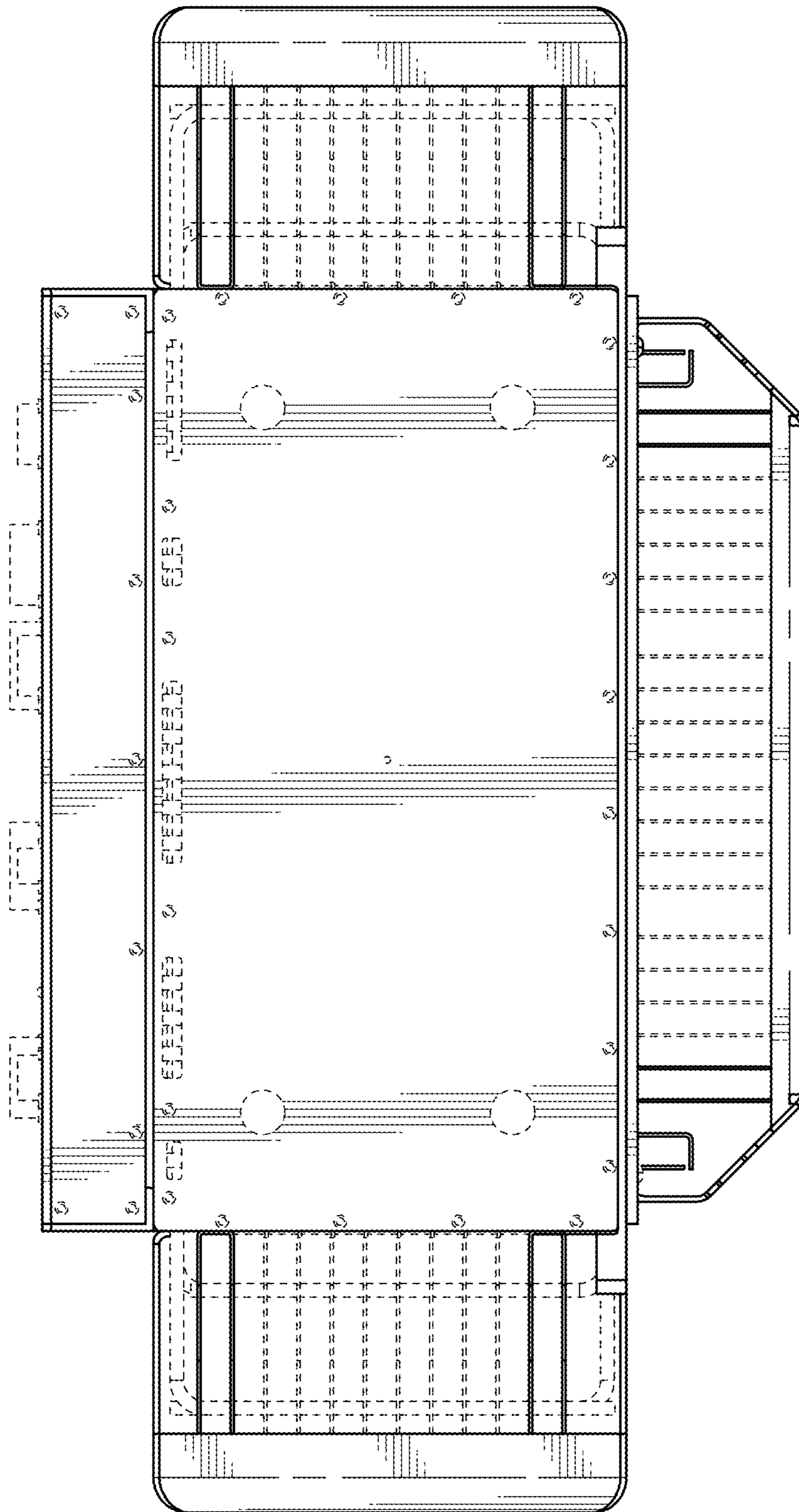

FIG. 7

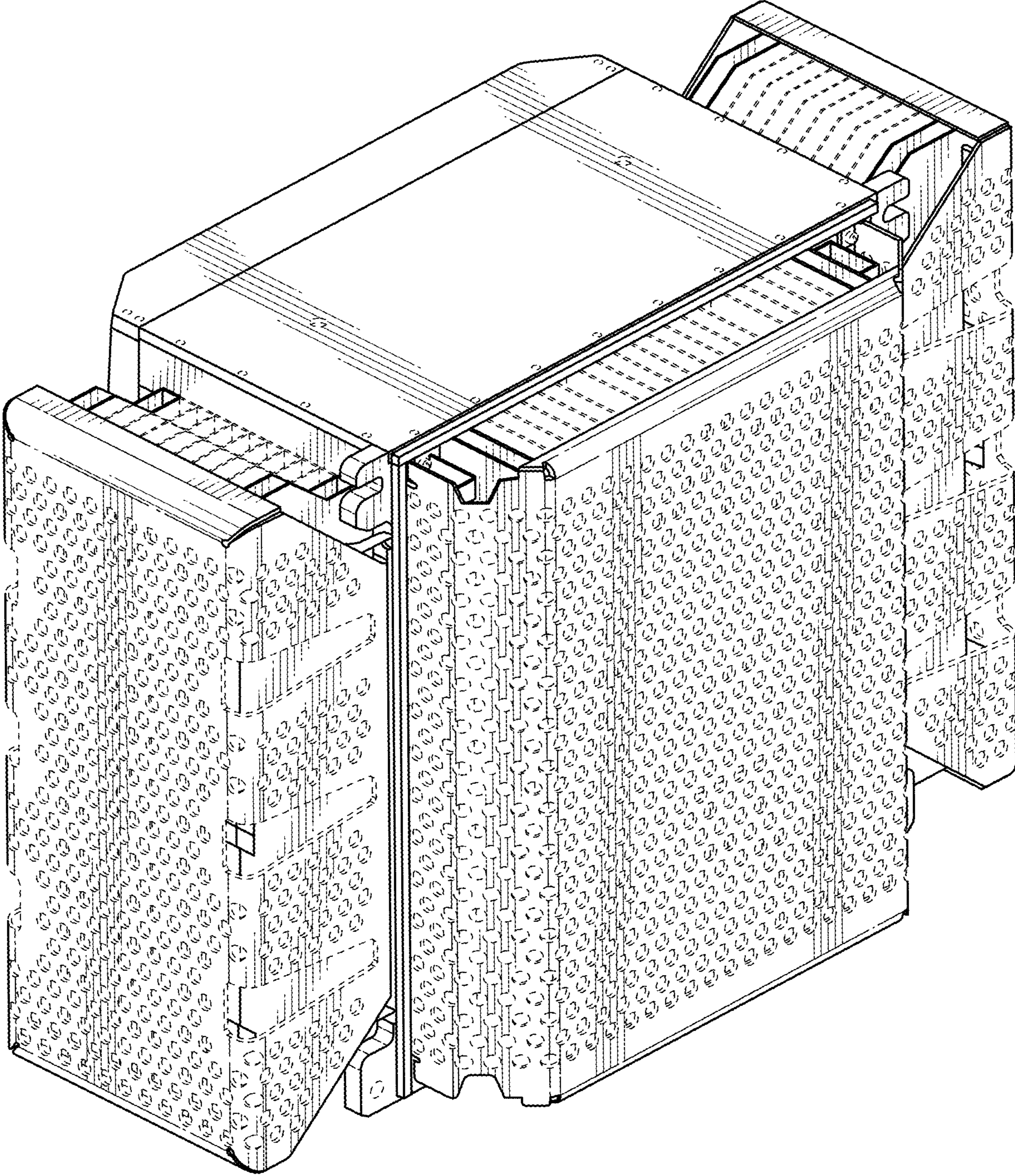

FIG. 8