



US00D873203S

(12) **United States Design Patent** (10) **Patent No.:** **US D873,203 S**
Grand (45) **Date of Patent:** **** Jan. 21, 2020**

(54) **ROOF FOR A VEHICLE**

(71) Applicant: **Jaguar Land Rover Limited**, Whitley, Coventry (GB)

(72) Inventor: **Simon Grand**, Coventry (GB)

(73) Assignee: **Jaguar Land Rover Limited**, Whitley, Coventry (GB)

(**) Term: **15 Years**

(21) Appl. No.: **29/656,108**

(22) Filed: **Jul. 10, 2018**

(30) **Foreign Application Priority Data**

Jan. 12, 2018 (EM) 004663839
Apr. 25, 2018 (EM) 005248622
Jul. 5, 2018 (EM) 005438009

(51) **LOC (12) Cl.** **12-16**

(52) **U.S. Cl.**
USPC **D12/412**

(58) **Field of Classification Search**
USPC D12/400-406, 412-413; D6/611, 596,
D6/601, 602, 603, 615; D7/332, 334-337
(Continued)

(56) **References Cited**

U.S. PATENT DOCUMENTS

D786,173 S * 5/2017 Peat D12/404
D803,141 S * 11/2017 Peat D12/401
(Continued)

Primary Examiner — Abraham Bahta

(74) *Attorney, Agent, or Firm* — Wood Herron & Evans LLP

(57) **CLAIM**

The ornamental design for a roof for a vehicle, as shown and described.

DESCRIPTION

FIG. 1 is a front left top perspective view of a roof for a vehicle according to the present invention.

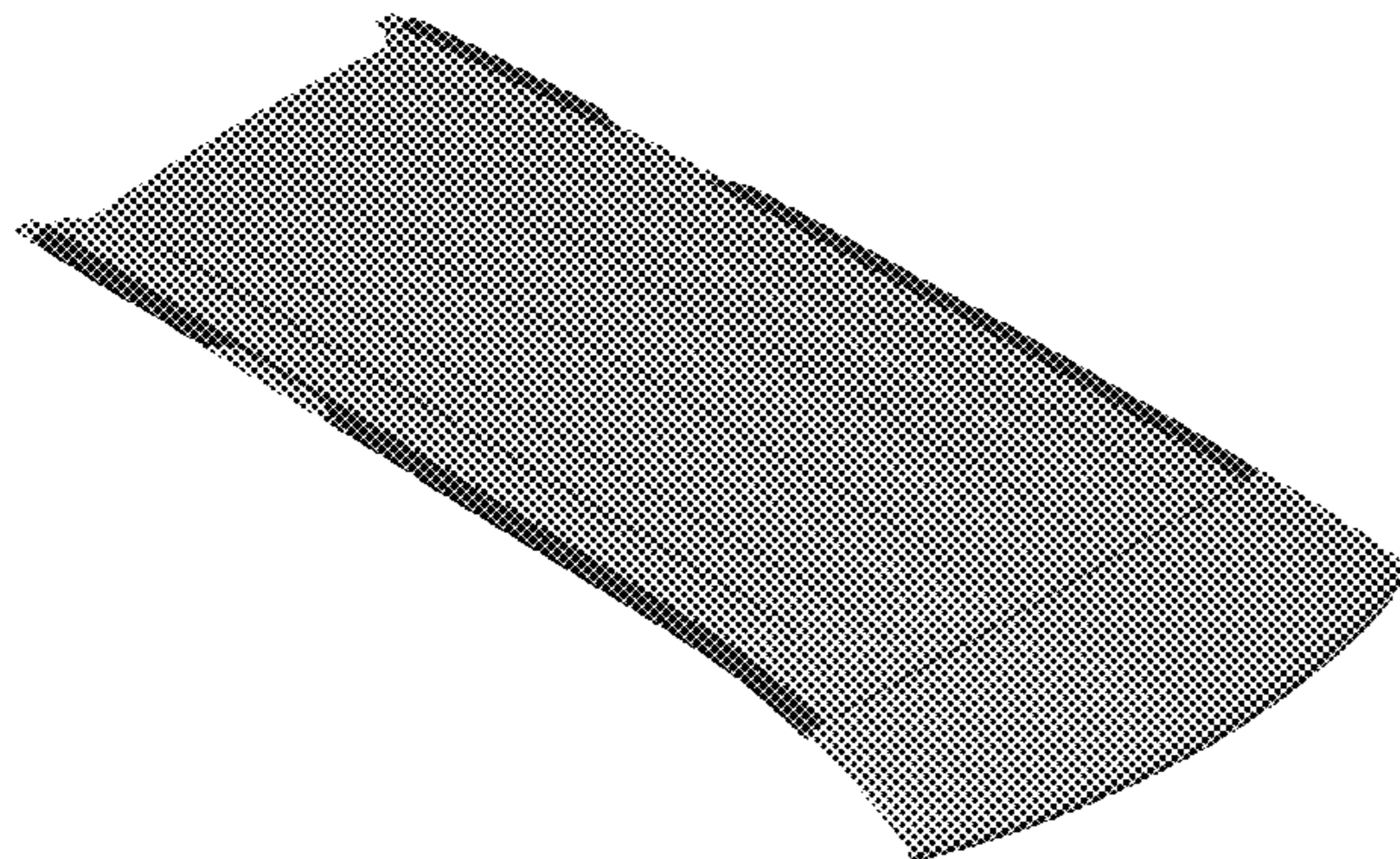

FIG. 2 is a rear right top perspective view of the roof shown in FIG. 1.

FIG. 3 is a front left perspective view thereof.

FIG. 4 is a rear right perspective view thereof.

FIG. 5 is a front view thereof.

FIG. 6 is a rear view thereof.

FIG. 7 is a left side view thereof.

FIG. 8 is a right side view thereof.

FIG. 9 is a top view thereof.

FIG. 10 is a bottom view thereof.

FIG. 11 is a top view of the roof shown in FIGS. 1-10, but with the roof mounted on a vehicle, and the rest of the vehicle shown in de-emphasized and half-tone portions to illustrate environmental structure. More particularly, in FIG. 11, the inventive vehicle roof is shown within the broken line, and the elements shown outside the broken line form no part of the claimed design, but are instead included to show environmental aspects thereof. The broken line forms an unclaimed boundary.

FIG. 12 is a front left top perspective of a roof for a vehicle according to a second embodiment of the present invention.

FIG. 13 is a rear right top perspective view of the roof shown in FIG. 12.

FIG. 14 is a front left perspective view thereof.

FIG. 15 is a rear right perspective view thereof.

FIG. 16 is a front view thereof.

FIG. 17 is a rear view thereof.

FIG. 18 is a left side view thereof.

FIG. 19 is a right side view thereof.

FIG. 20 is a top view thereof.

FIG. 21 is a bottom view thereof.

FIG. 22 is a top view of the roof shown in FIGS. 12-21, but with the roof mounted on a vehicle, and the rest of the vehicle shown in de-emphasized and half-tone portions to illustrate environmental structure. More particularly, in FIG. 22, the inventive roof is shown within the broken line, and the elements shown outside the broken line form no part of the claimed design, but are instead included to show environmental aspects thereof. The broken line forms an unclaimed boundary.

FIG. 23 is a front left top perspective of a roof for a vehicle according to a third embodiment of the present invention.

(Continued)

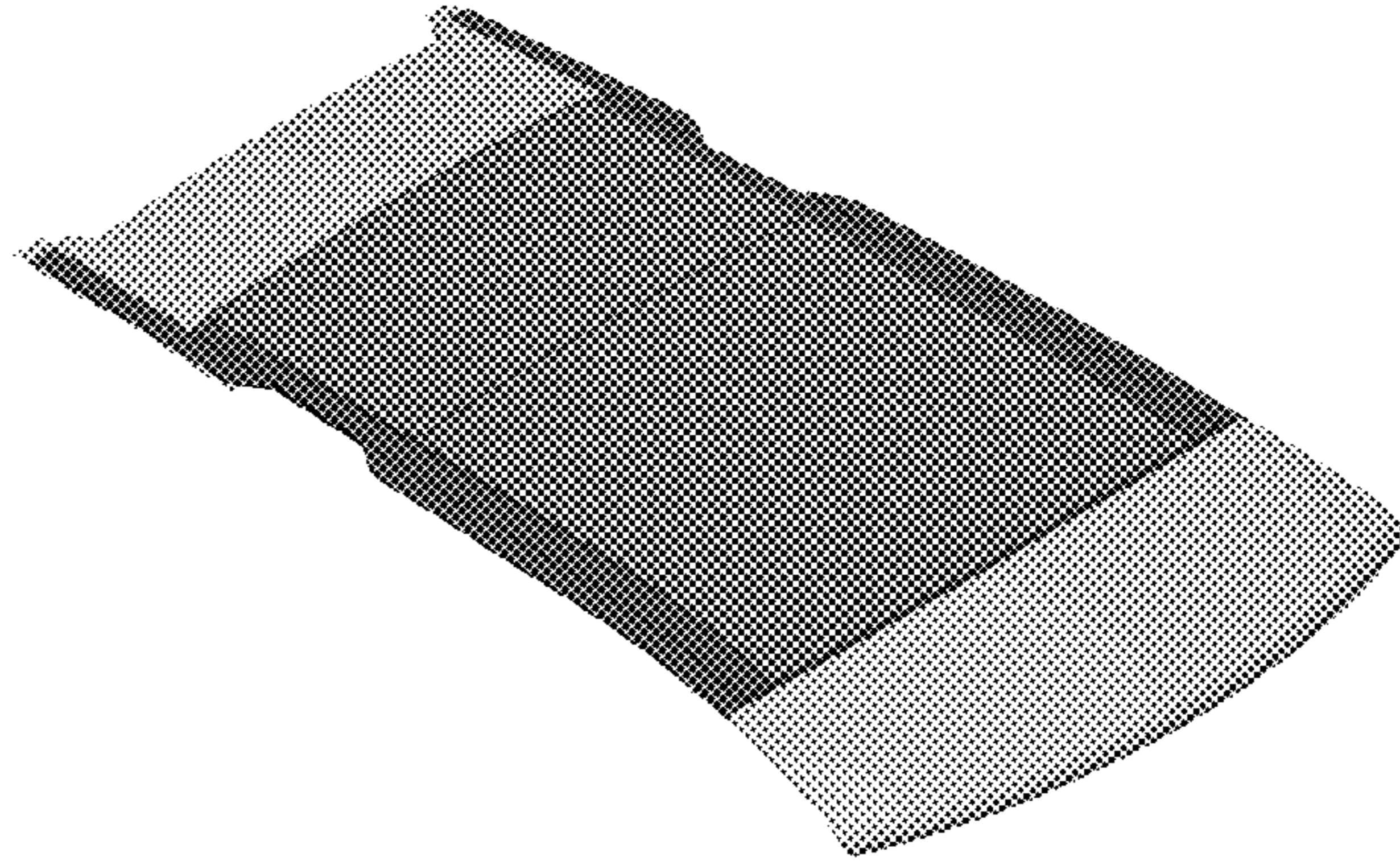

FIG. 24 is a rear right top perspective view of the roof shown in FIG. 1.

FIG. 25 is a front left perspective view thereof.

FIG. 26 is a rear right perspective view thereof.

FIG. 27 is a front view thereof.

FIG. 28 is a rear view thereof.

FIG. 29 is a left side view thereof.

FIG. 30 is a right side view thereof.

FIG. 31 is a top view thereof.

FIG. 32 is a bottom view thereof.

FIG. 33 is a top view of the roof shown in FIGS. 23-32, but with the roof mounted on a vehicle, and the rest of the vehicle shown in de-emphasized and half-tone portions to illustrate environmental structure. More particularly, in FIG. 33, the inventive roof is shown within the broken line, and the elements shown outside the broken line form no part of the claimed design, but are instead included to show environmental aspects thereof. The broken line forms an unclaimed boundary.

FIG. 34 is a front left top perspective of a roof for a vehicle according to a fourth embodiment of the present invention.

FIG. 35 is a rear right top perspective view of the roof shown in FIG. 34.

FIG. 36 is a front left perspective view thereof.

FIG. 37 is a rear right perspective view thereof.

FIG. 38 is a front view thereof.

FIG. 39 is a rear view thereof.

FIG. 40 is a left side view thereof.

FIG. 41 is a right side view thereof.

FIG. 42 is a top view thereof.

FIG. 43 is a bottom view thereof.

FIG. 44 is a top view of the roof shown in FIGS. 34-43, but with the roof mounted on a vehicle, and the rest of the vehicle shown in de-emphasized and half-tone portions to illustrate environmental structure. More particularly, in FIG. 44, the inventive roof is shown within the broken line, and the elements shown outside the broken line form no part of the claimed design, but are instead included to show environmental aspects thereof. The broken line forms an unclaimed boundary.

FIG. 45 is a front left top perspective of a roof for a vehicle according to a fifth embodiment of the present invention.

FIG. 46 is a rear right top perspective view of the roof shown in FIG. 45.

FIG. 47 is a front left perspective view thereof.

FIG. 48 is a rear right perspective view thereof.

FIG. 49 is a front view thereof.

FIG. 50 is a rear view thereof.

FIG. 51 is a left side view thereof.

FIG. 52 is a right side view thereof.

FIG. 53 is a top view thereof.

FIG. 54 is a bottom view thereof.

FIG. 55 is a top view of the roof shown in FIGS. 45-54, but with the roof mounted on a vehicle, and the rest of the vehicle shown in de-emphasized and half-tone portions to illustrate environmental structure. More particularly, in FIG. 55, the inventive roof is shown within the broken line, and the elements shown outside the broken line form no part of the claimed design, but are instead included to show environmental aspects thereof. The broken line forms an unclaimed boundary.

FIG. 56 is a front left top perspective of a roof for a vehicle according to a sixth embodiment of the present invention.

FIG. 57 is a rear right top perspective view of the roof shown in FIG. 56.

FIG. 58 is a front left perspective view thereof.

FIG. 59 is a rear right perspective view thereof.

FIG. 60 is a front view thereof.

FIG. 61 is a rear view thereof.

FIG. 62 is a left side view thereof.

FIG. 63 is a right side view thereof.

FIG. 64 is a top view thereof.

FIG. 65 is a bottom view thereof; and,

FIG. 66 is a top view of the roof shown in FIGS. 56-65, but with the roof mounted on a vehicle, and the rest of the vehicle shown in de-emphasized and half-tone portions to illustrate environmental structure. More particularly, in FIG. 66, the inventive roof is shown within the broken line, and the elements shown outside the broken line form no part of the claimed design, but are instead included to show environmental aspects thereof. The broken line forms an unclaimed boundary.

1 Claim, 48 Drawing Sheets

(58) **Field of Classification Search**

CPC A47D 15/00; A47C 7/66; A47C 31/00;
 B60K 16/00; B60J 7/08; B60J 7/22; B60J
 7/1265; B60J 1/024; B60J 7/19; B60J
 7/0435; B60J 10/10; B60J 10/273; B62J
 1/18; B62J 1/26; B62J 1/34; B62J 1/28;
 B62J 1/22

See application file for complete search history.

(56) **References Cited**

U.S. PATENT DOCUMENTS

D841,563 S * 2/2019 Beckles D12/401
 D852,105 S * 6/2019 Chan D12/196
 D852,726 S * 7/2019 Varga D12/404

* cited by examiner

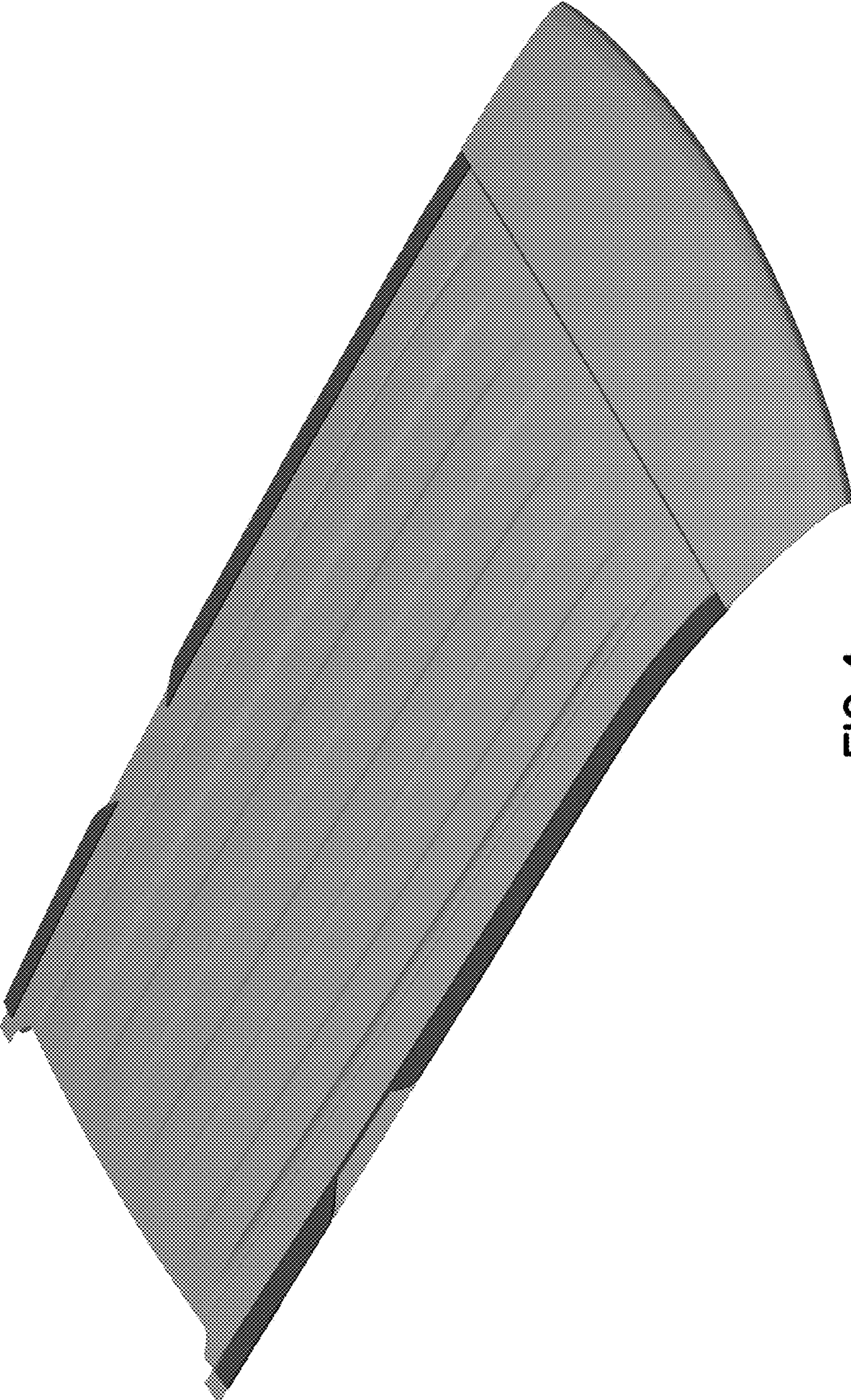

FIG. 1



FIG. 2

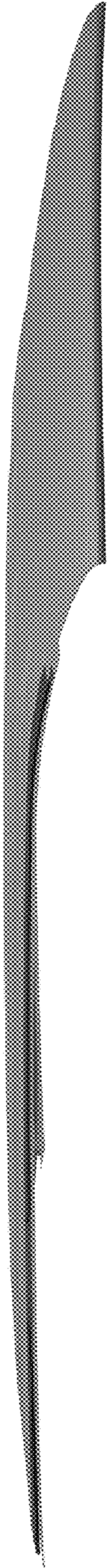

FIG. 3

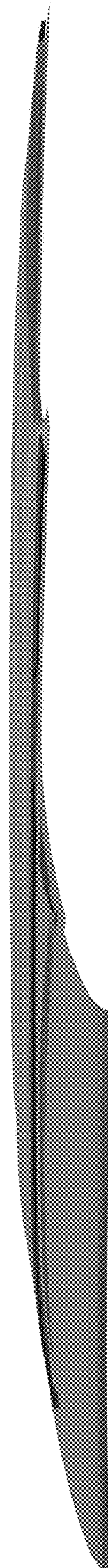

FIG. 4

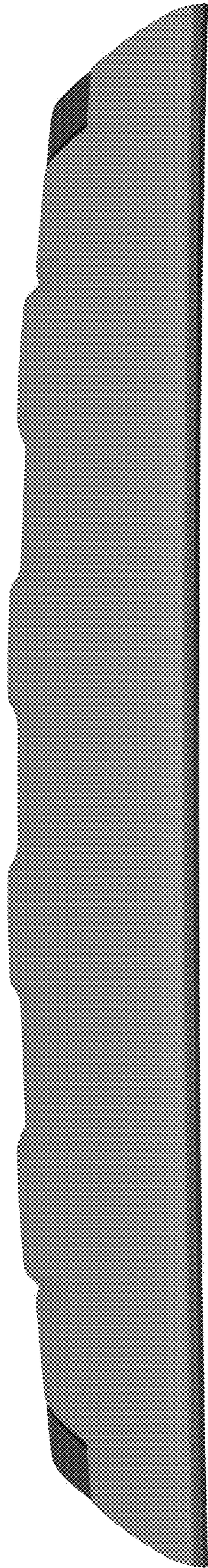

FIG. 5

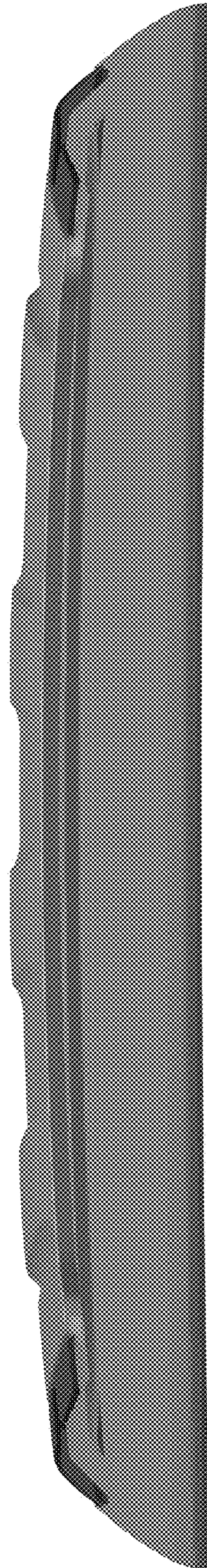

FIG. 6

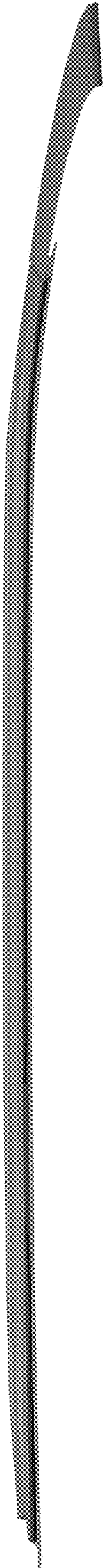

FIG. 7

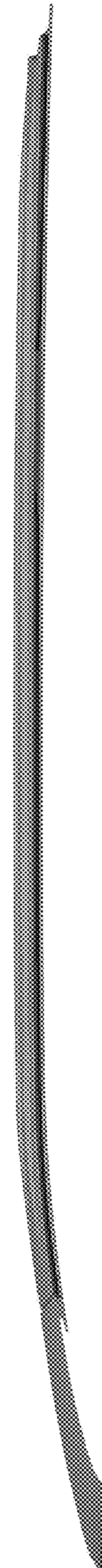

FIG. 8

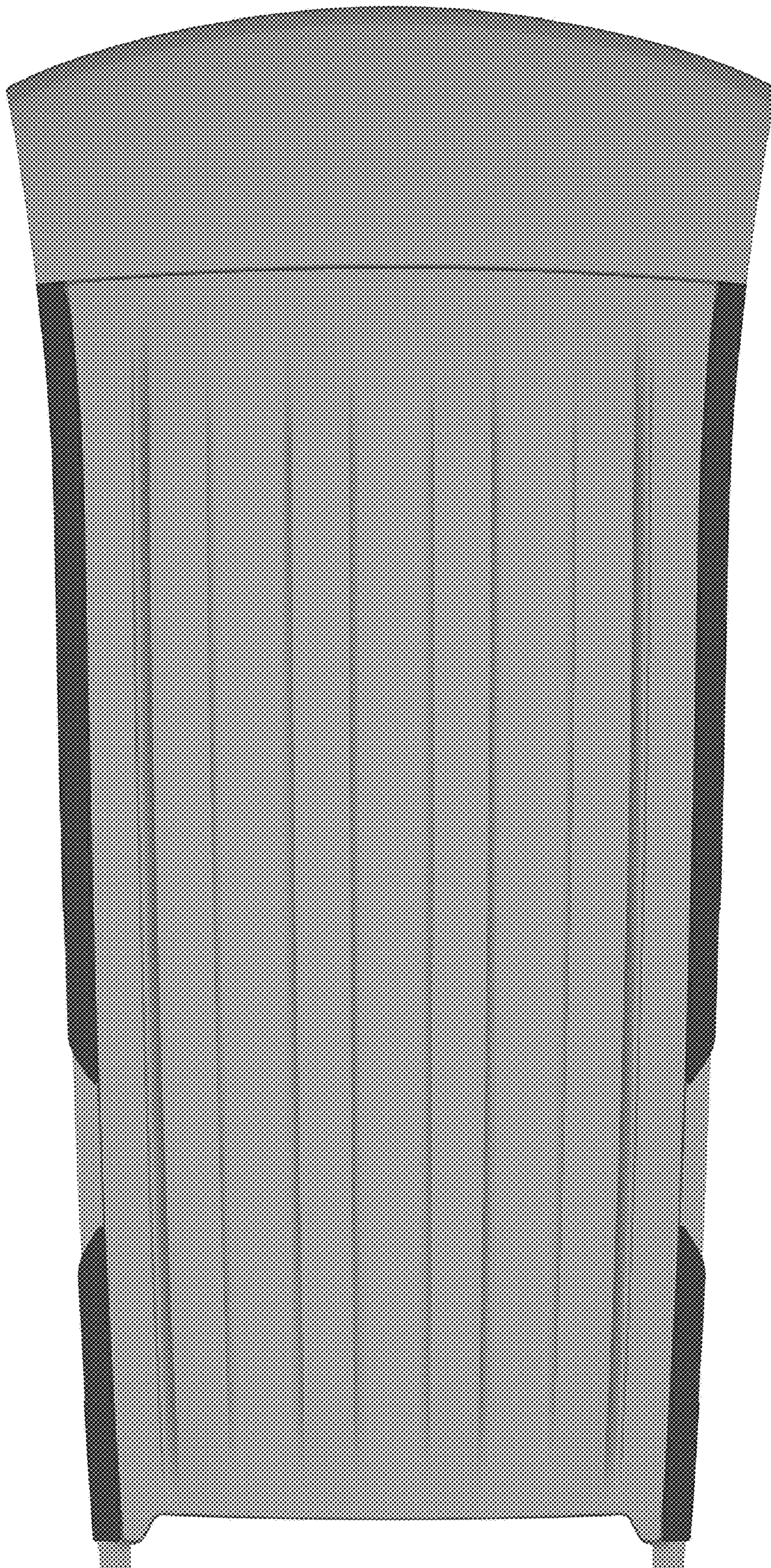

FIG. 9

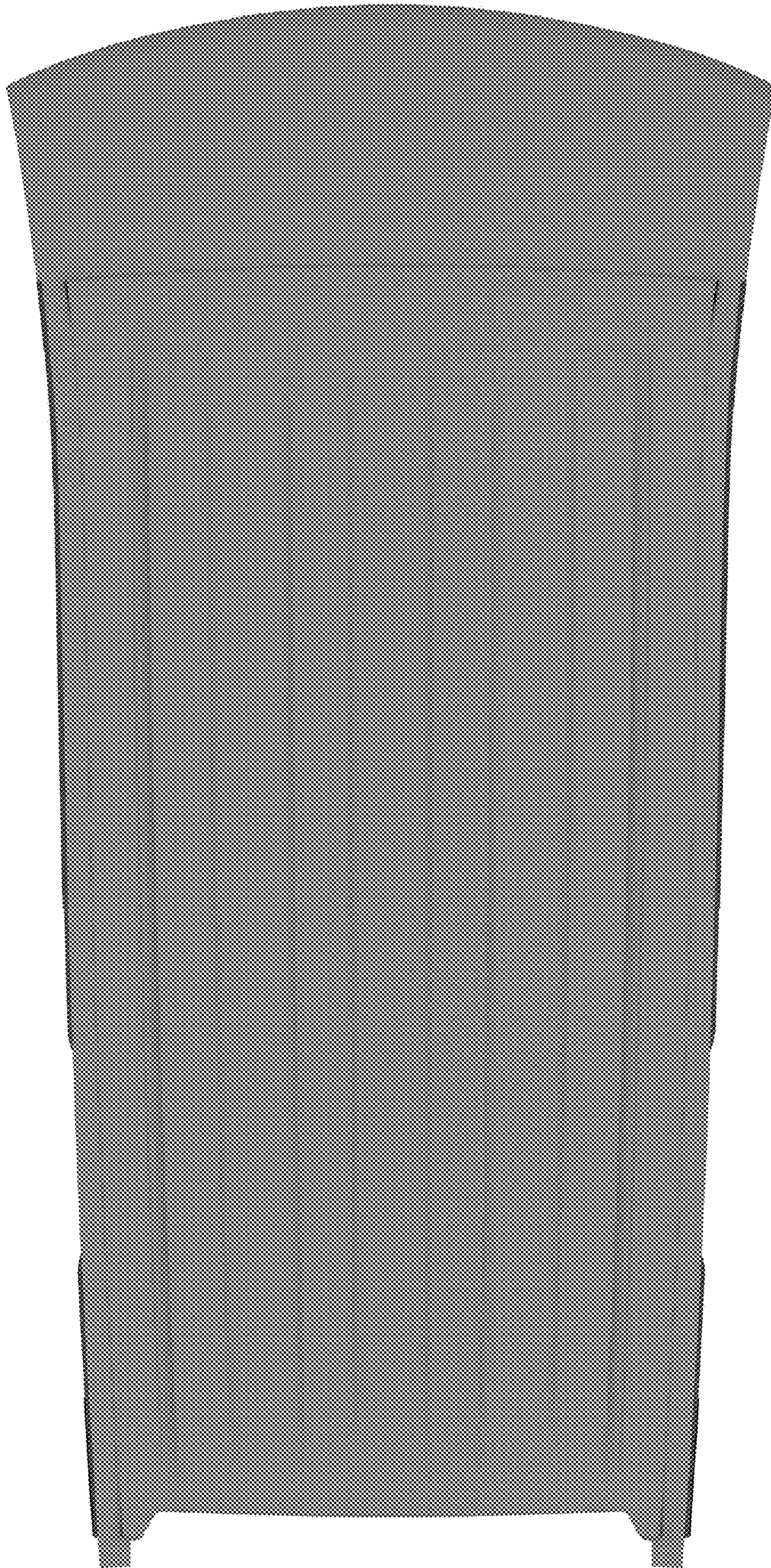

FIG. 10

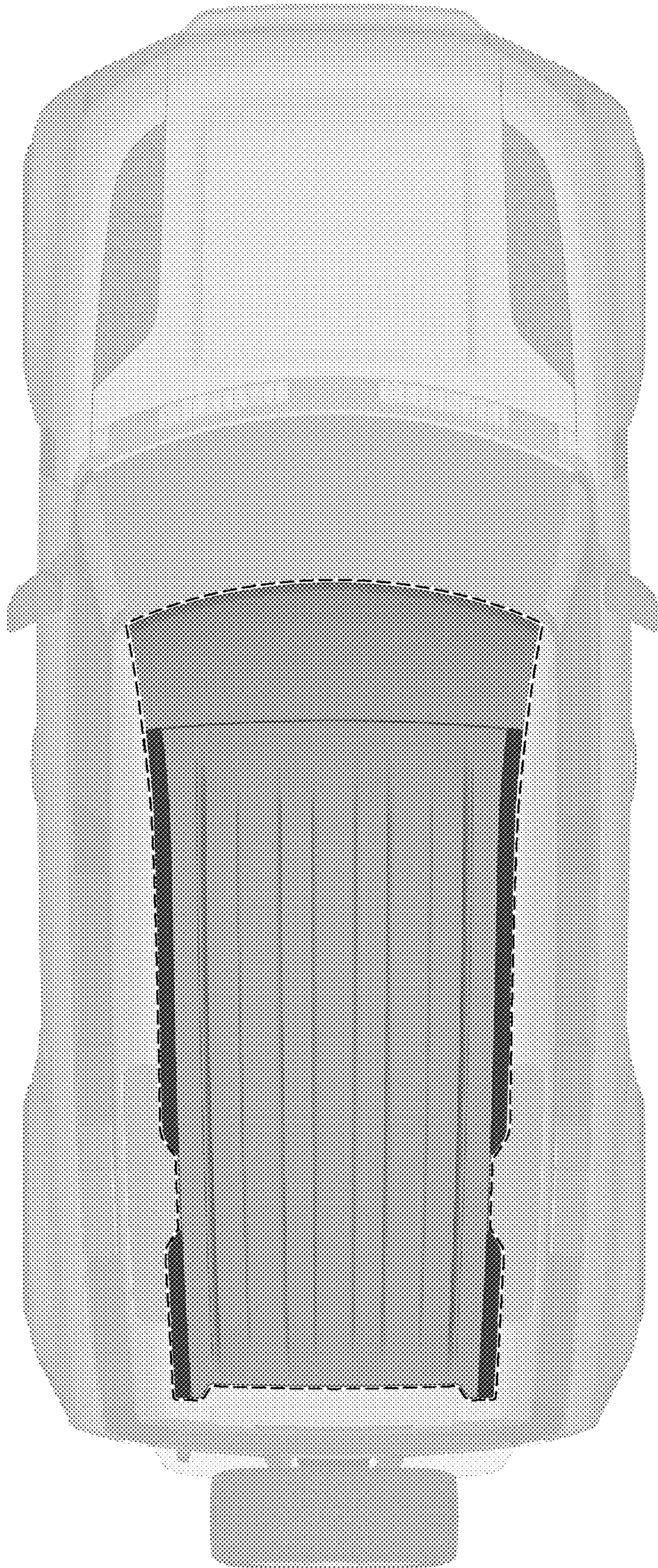

FIG. 11

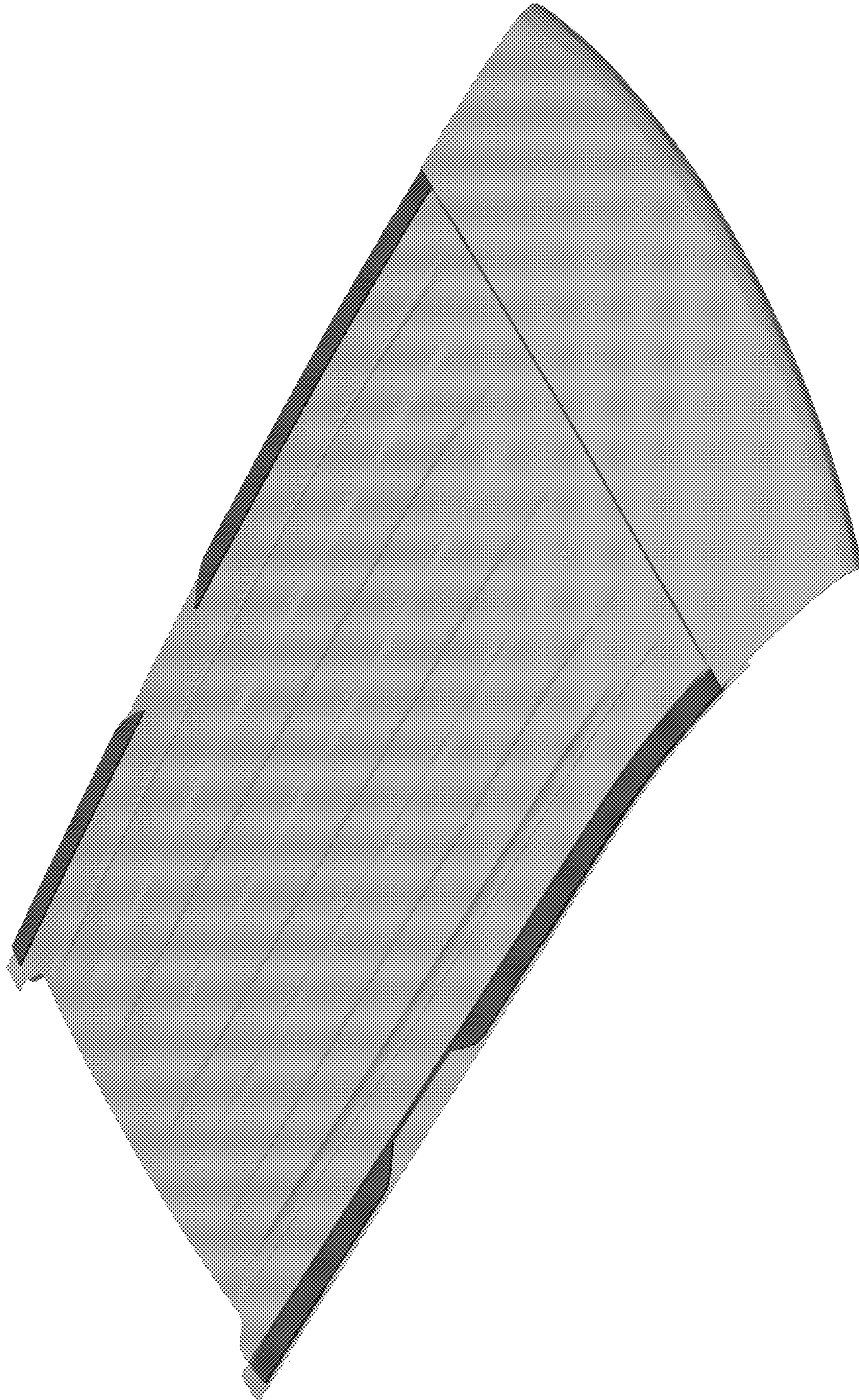

FIG. 12

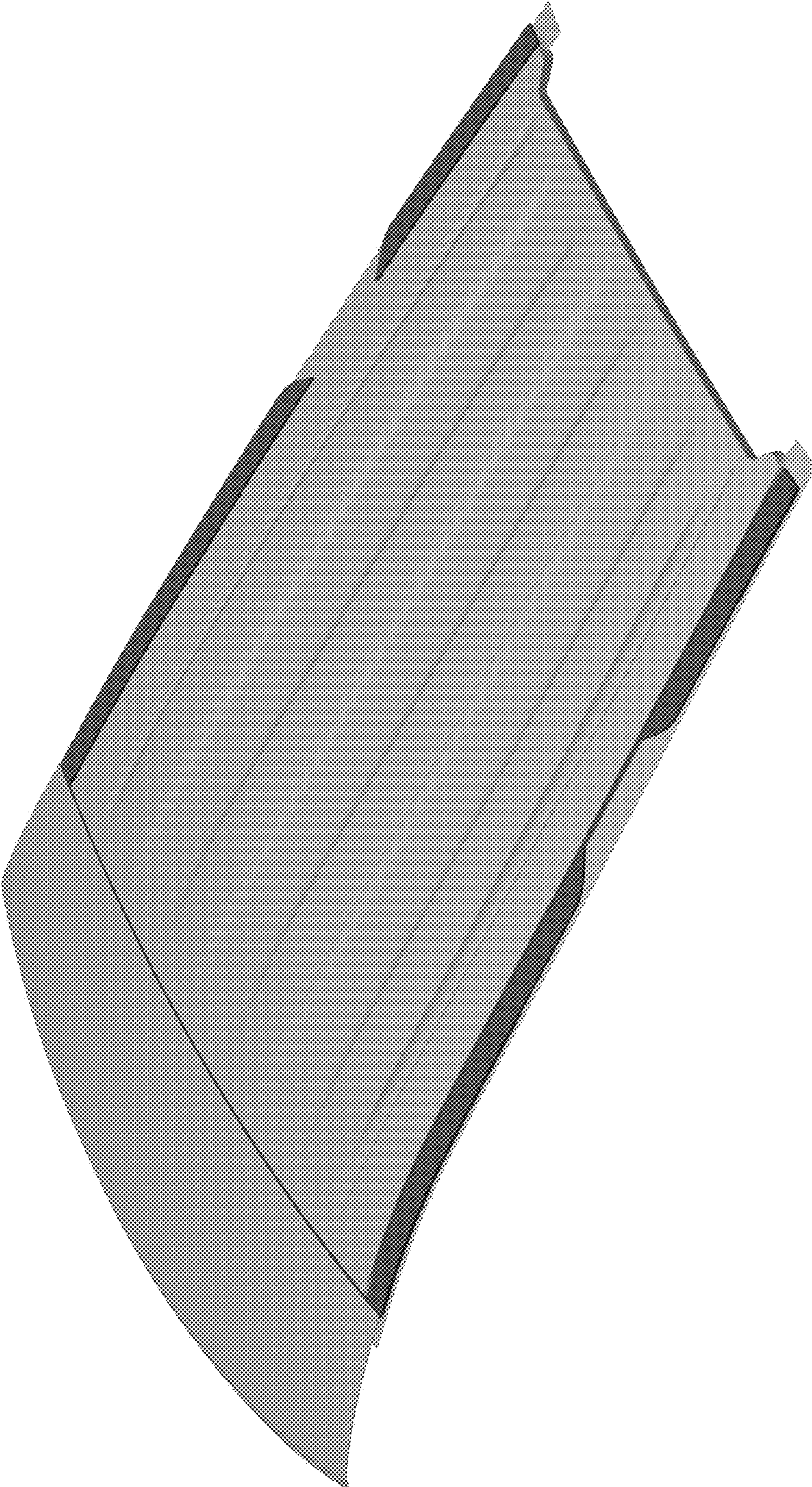

FIG. 13

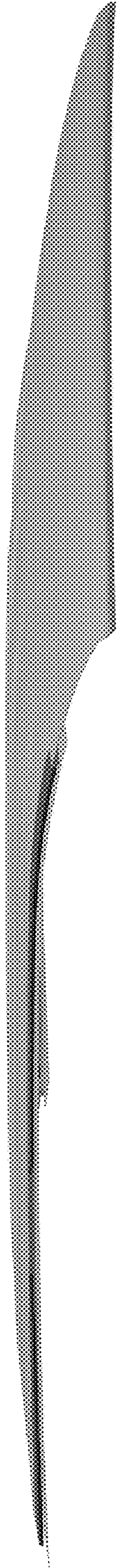

FIG. 14

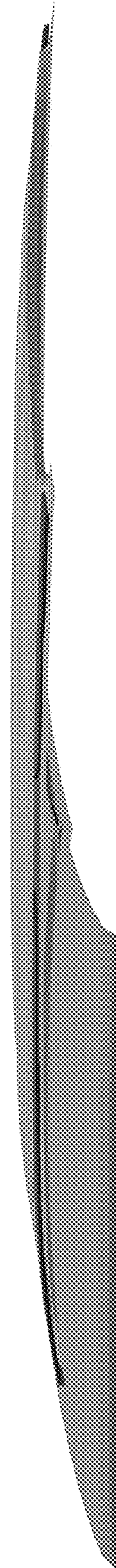

FIG. 15

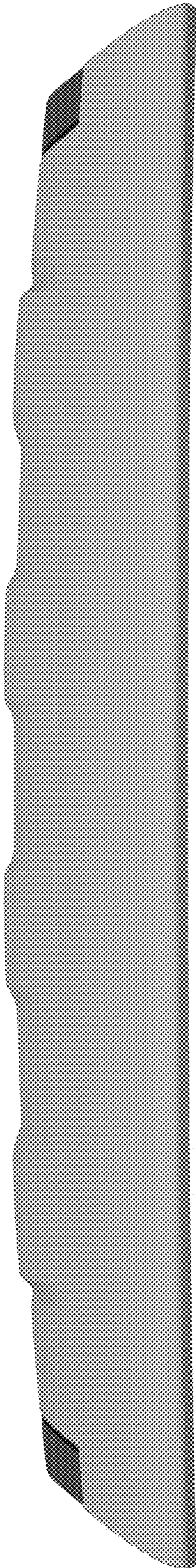

FIG. 16

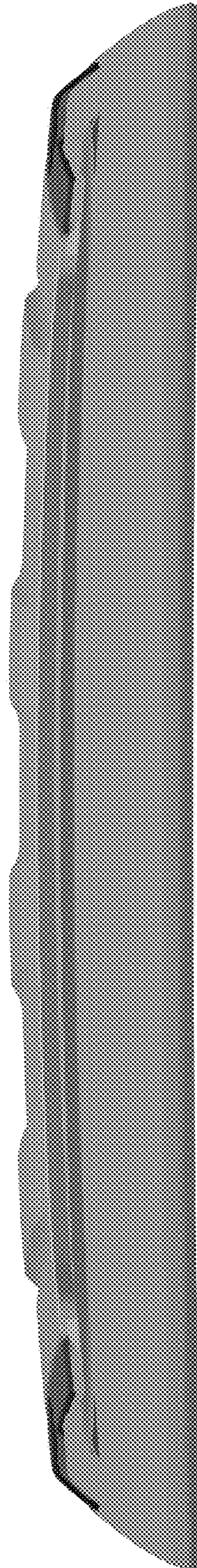

FIG. 17

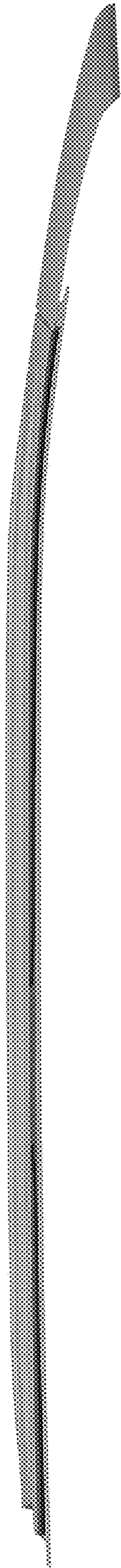

FIG. 18

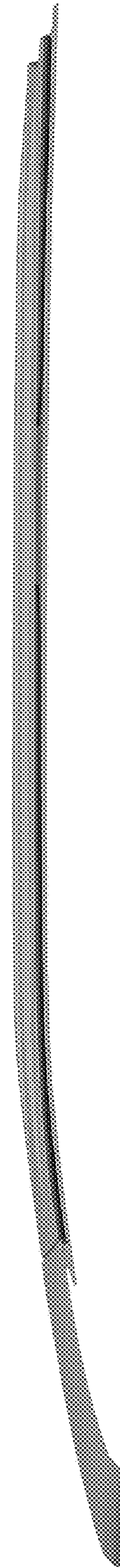

FIG. 19

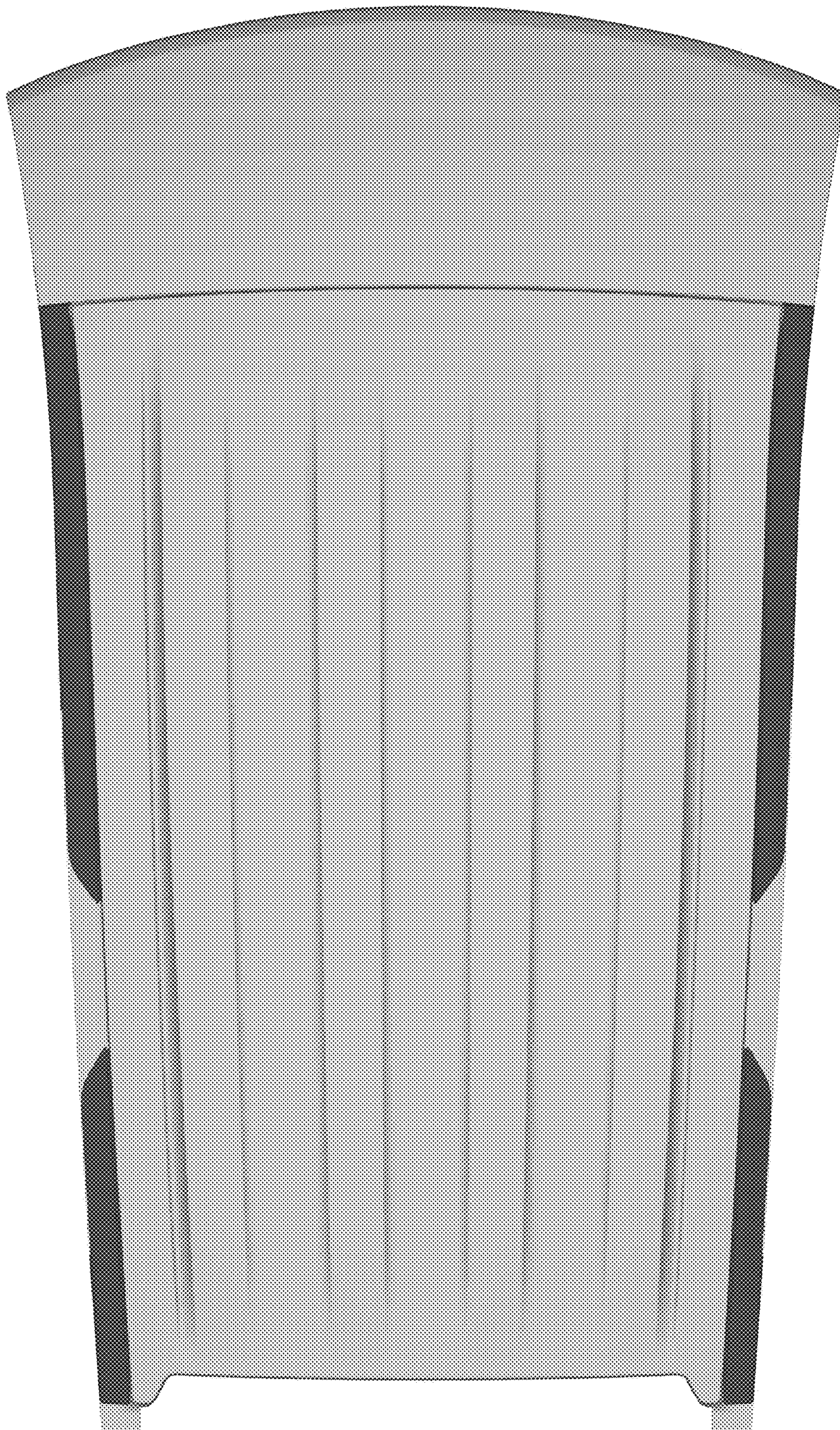

FIG. 20

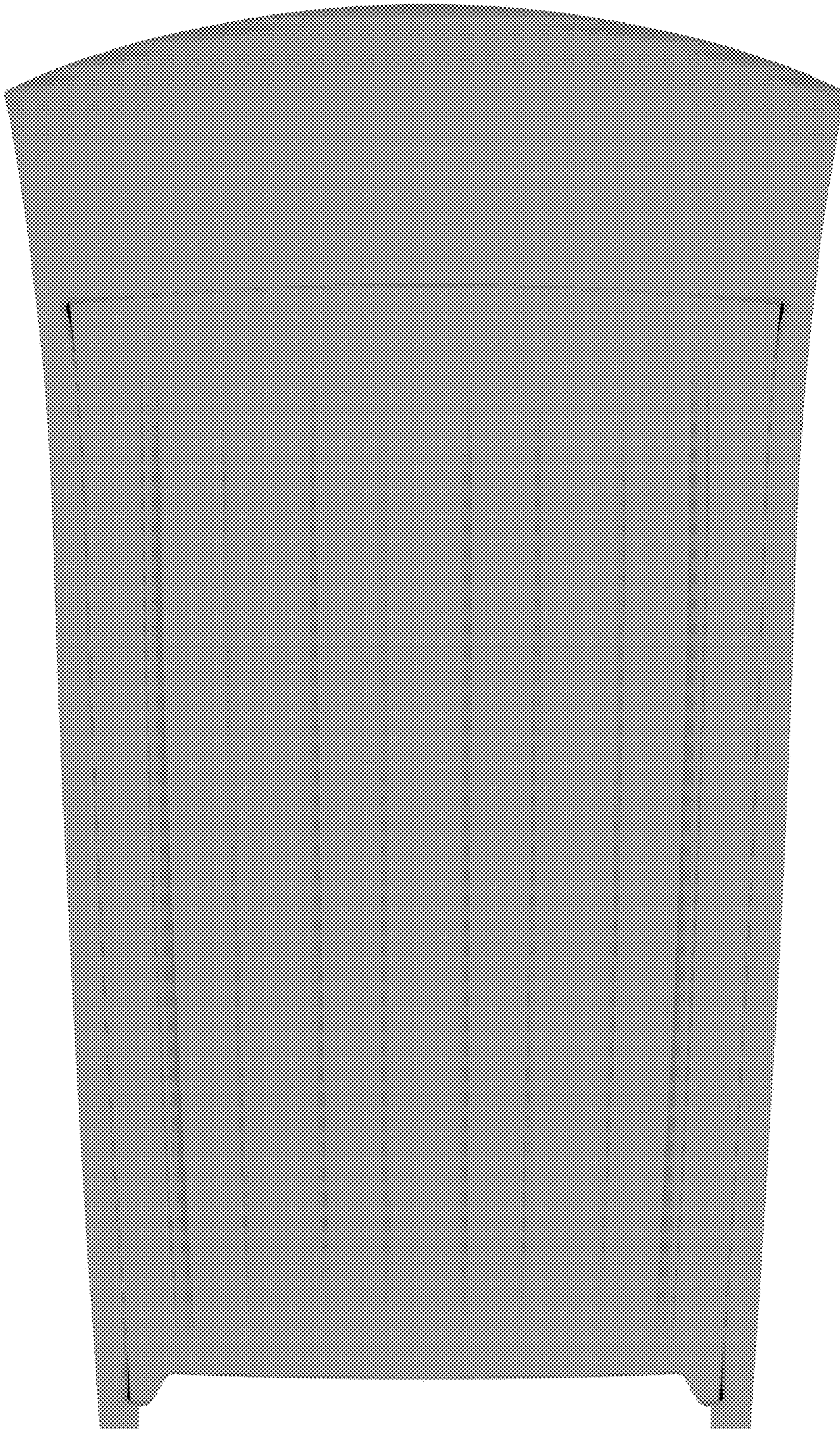

FIG. 21

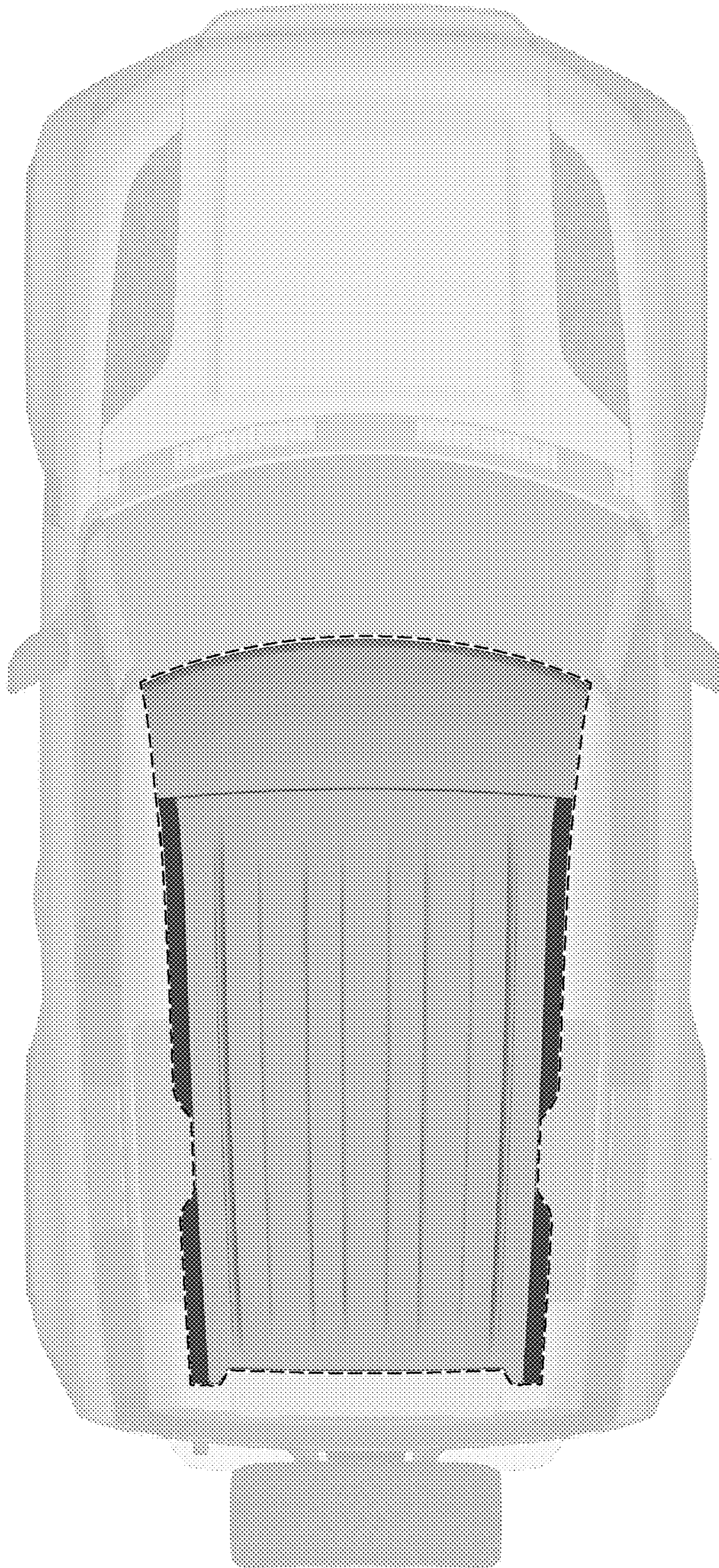

FIG. 22

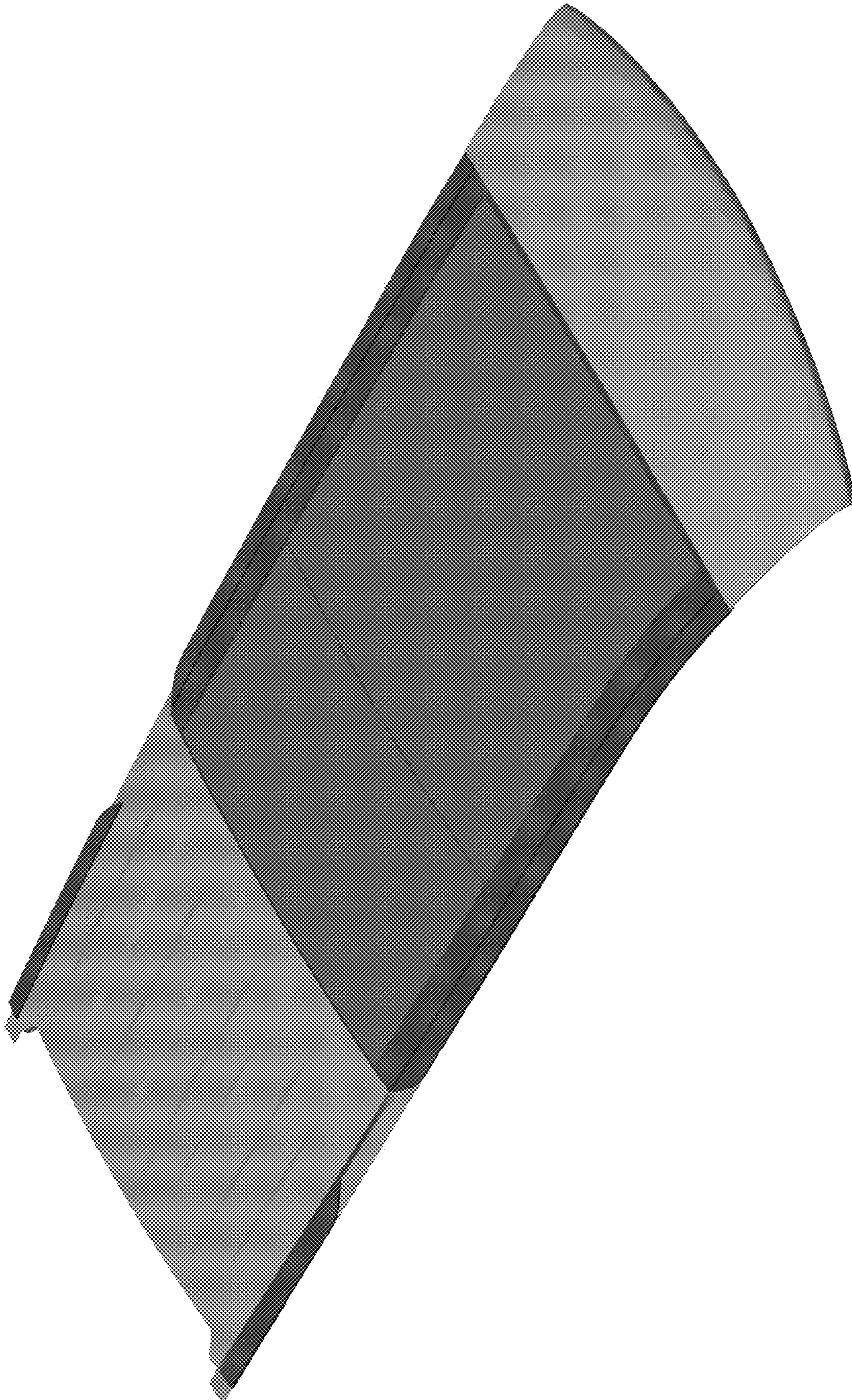

FIG. 23

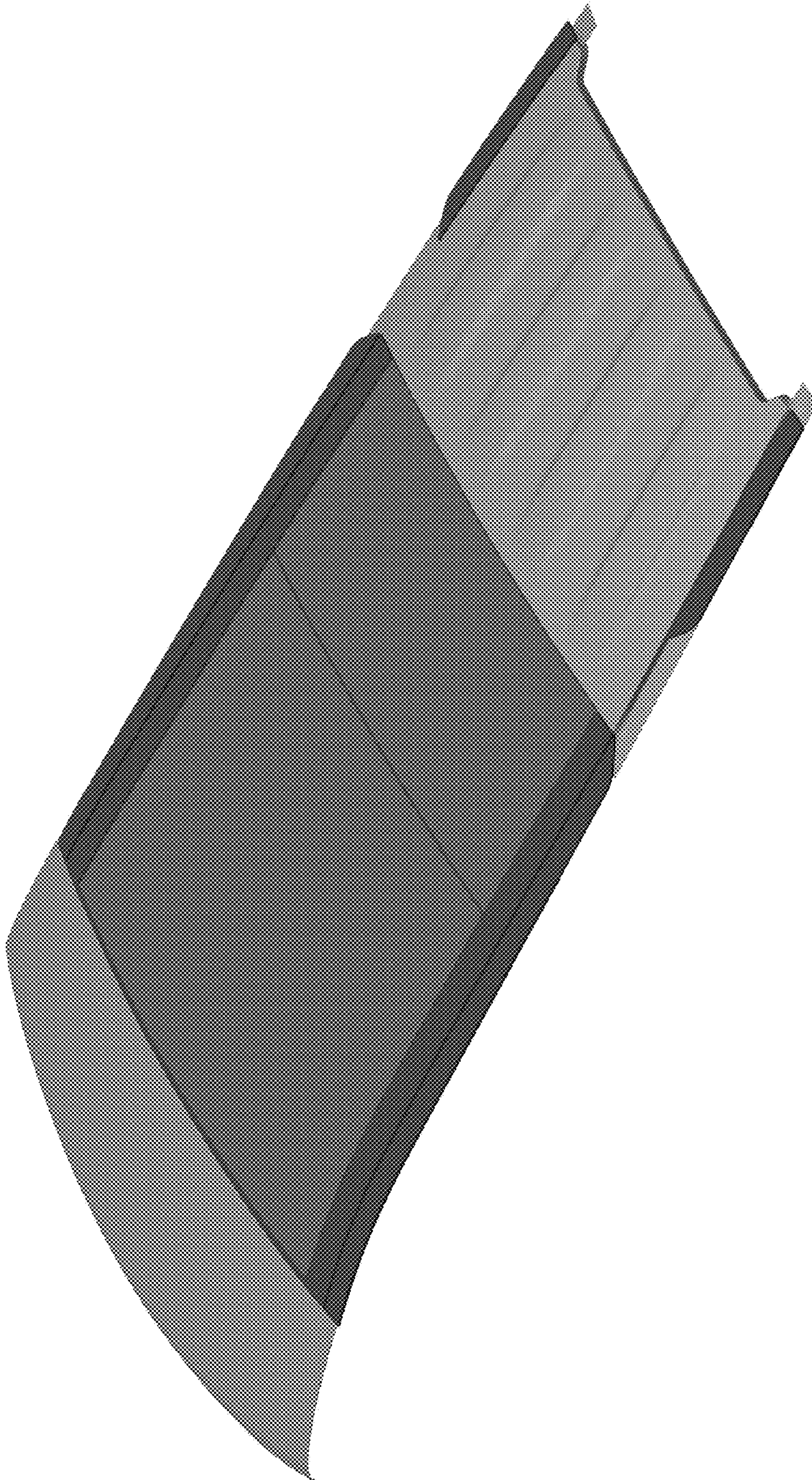

FIG. 24

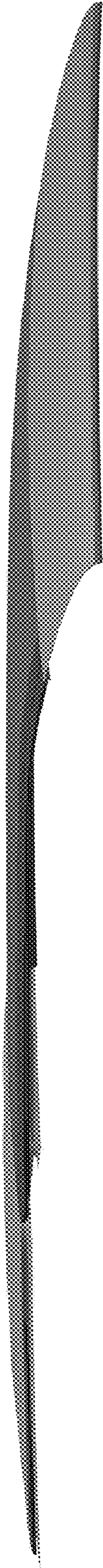

FIG. 25

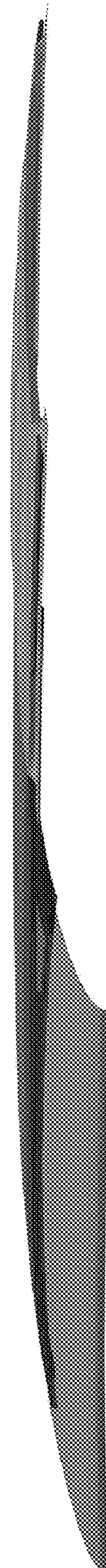

FIG. 26

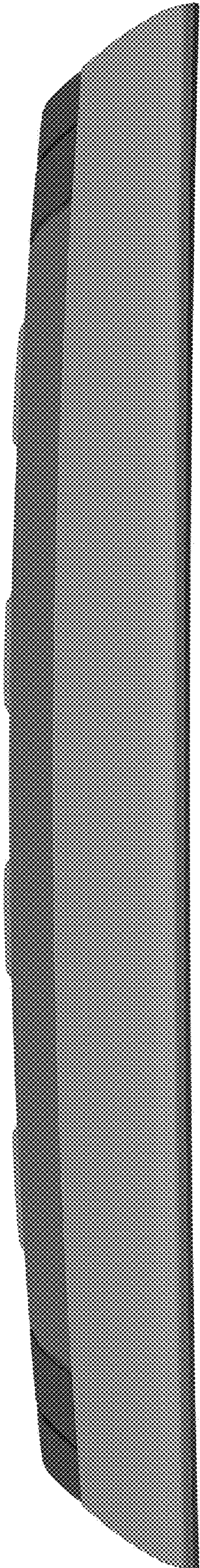

FIG. 27

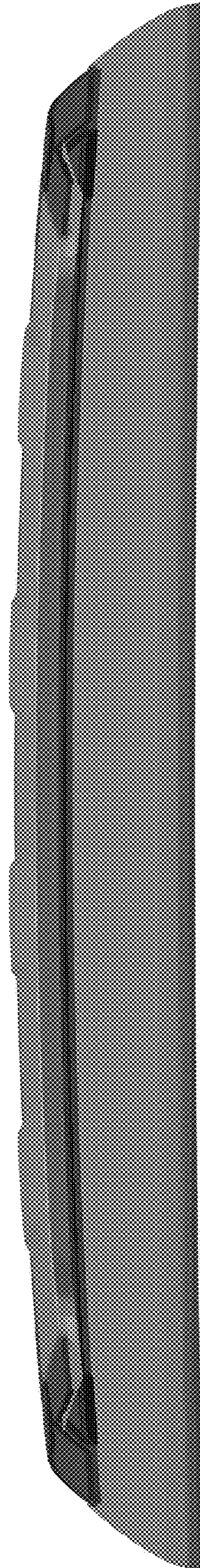

FIG. 28

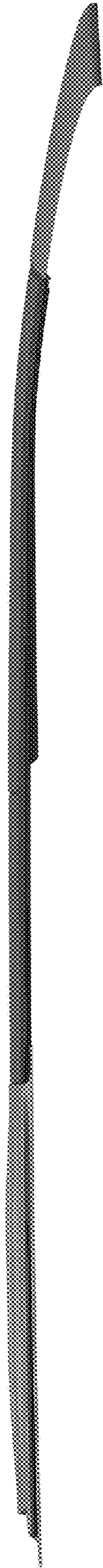

FIG. 29

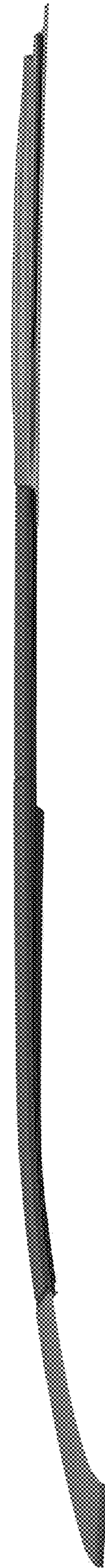

FIG. 30

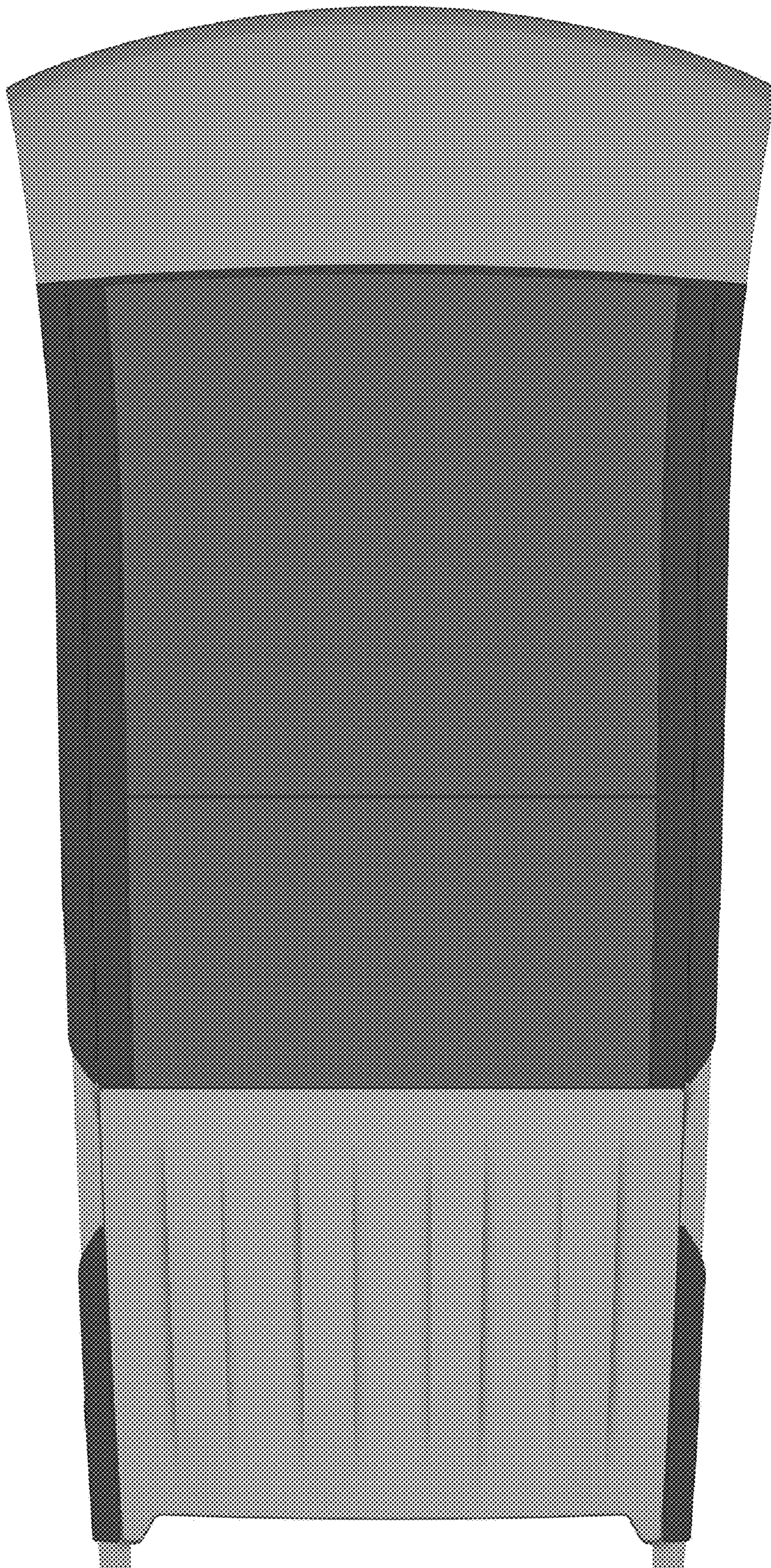

FIG. 31

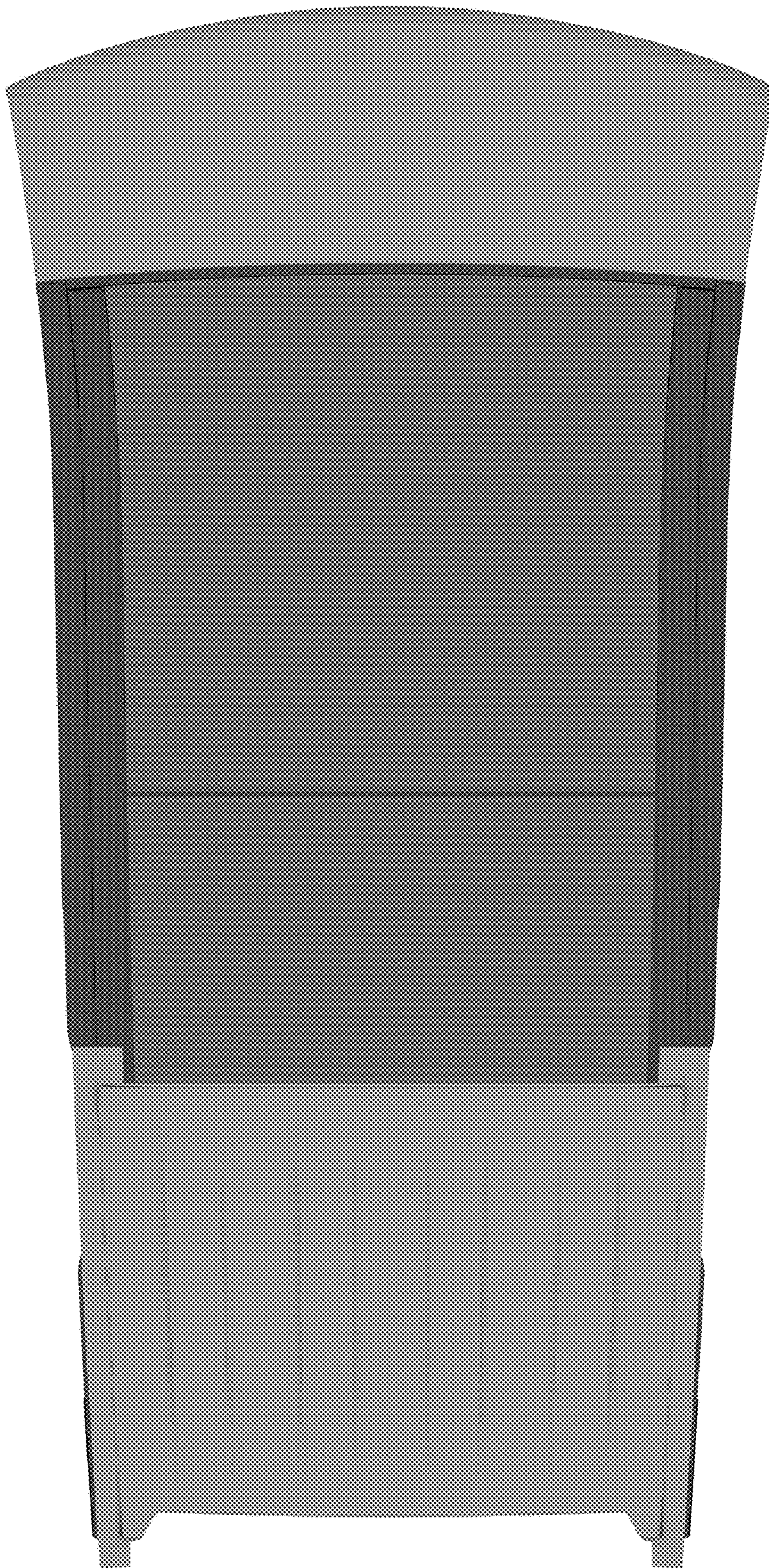

FIG. 32

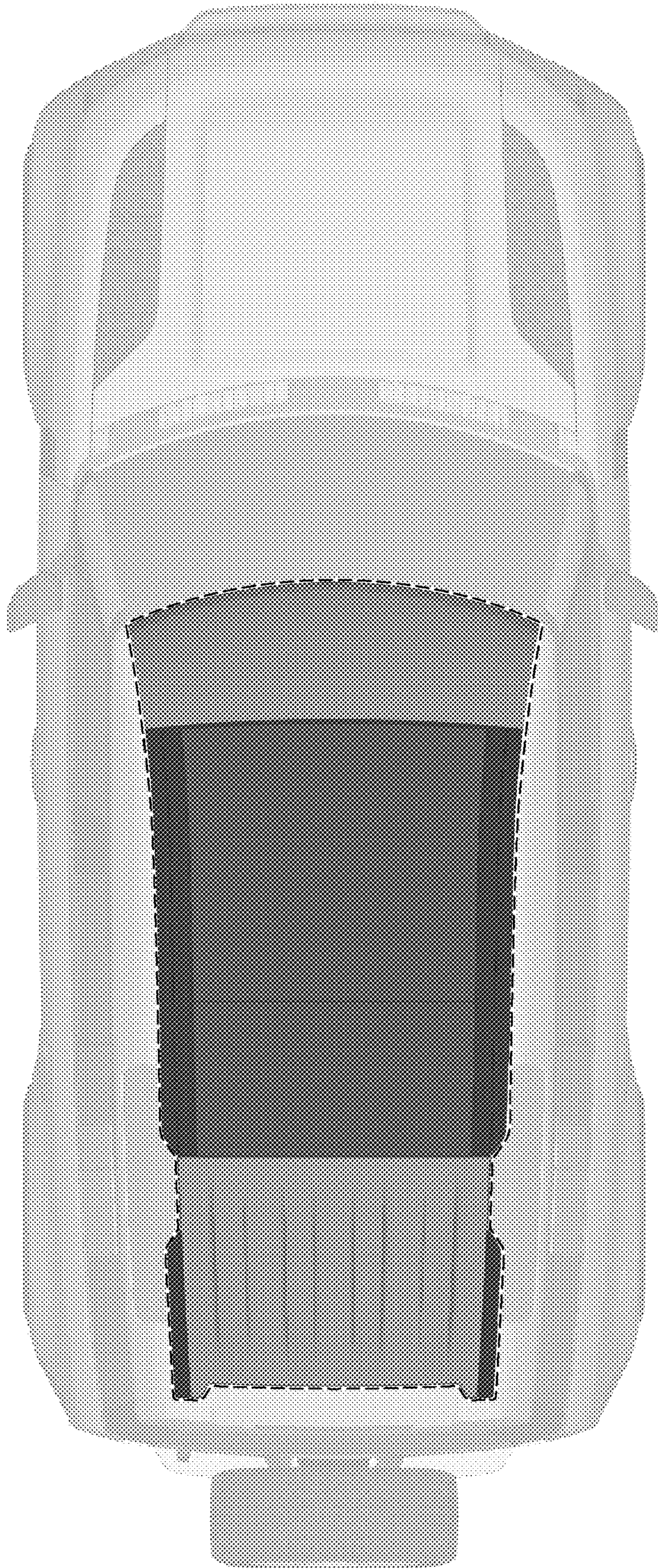

FIG. 33

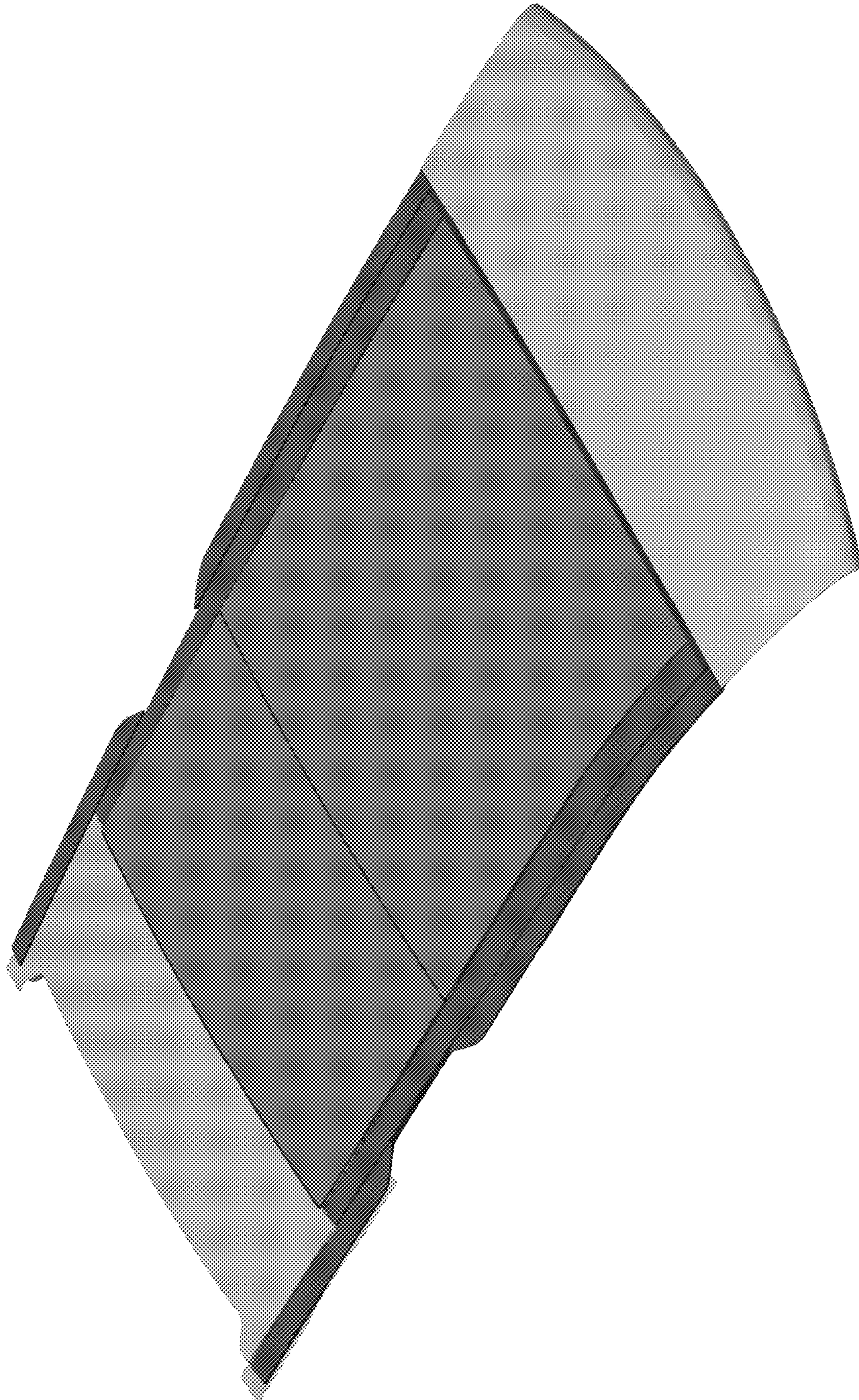

FIG. 34

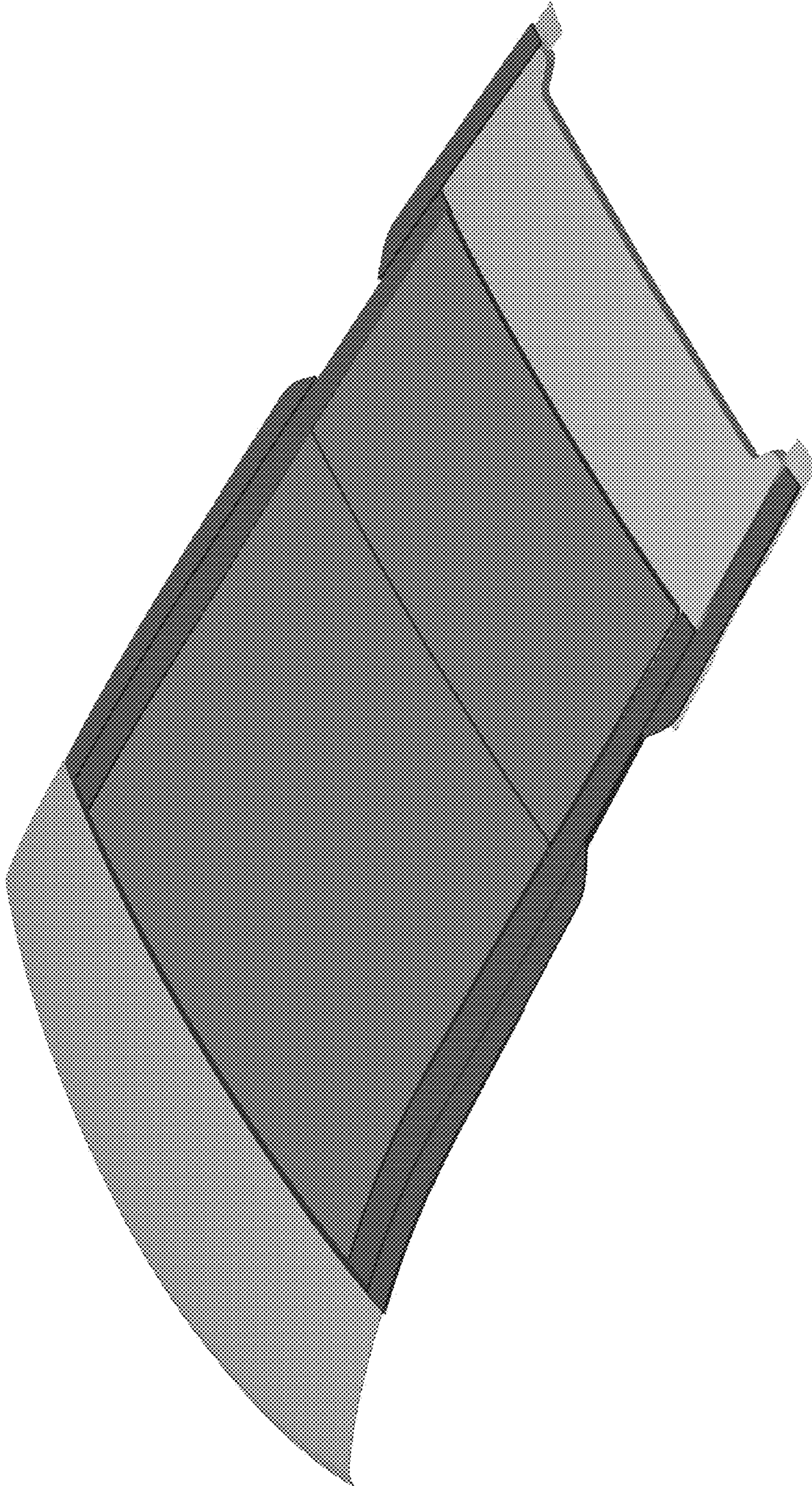

FIG. 35

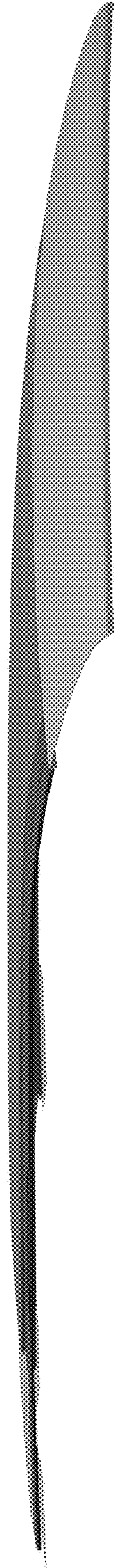

FIG. 36

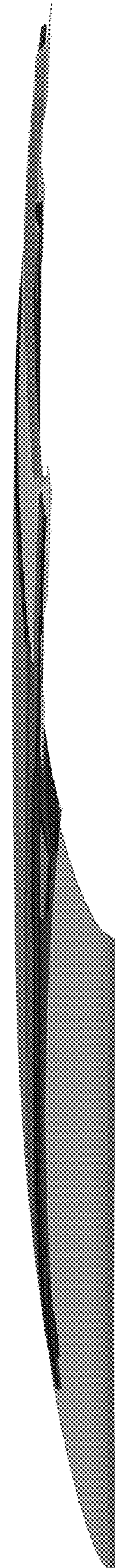

FIG. 37

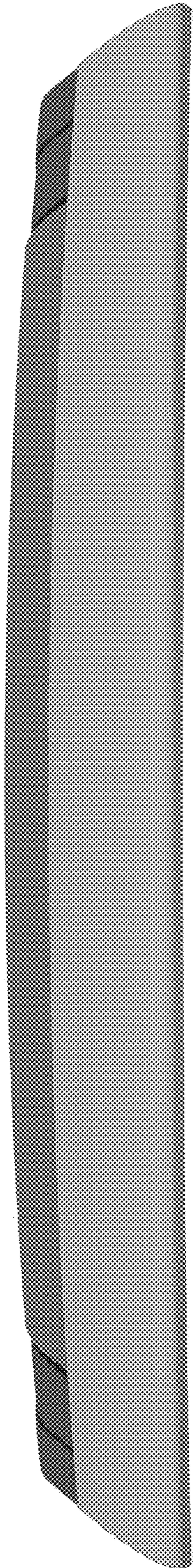

FIG. 38

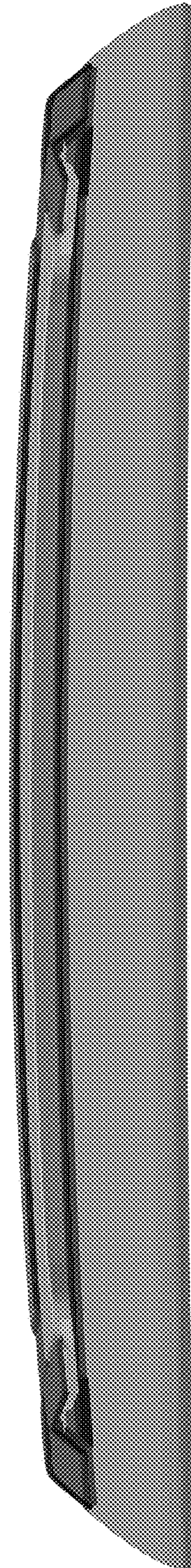

FIG. 39

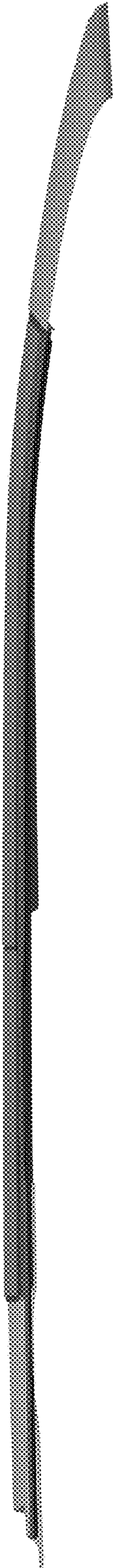

FIG. 40

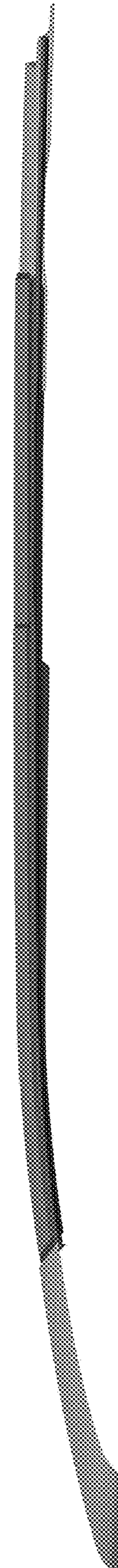

FIG. 41

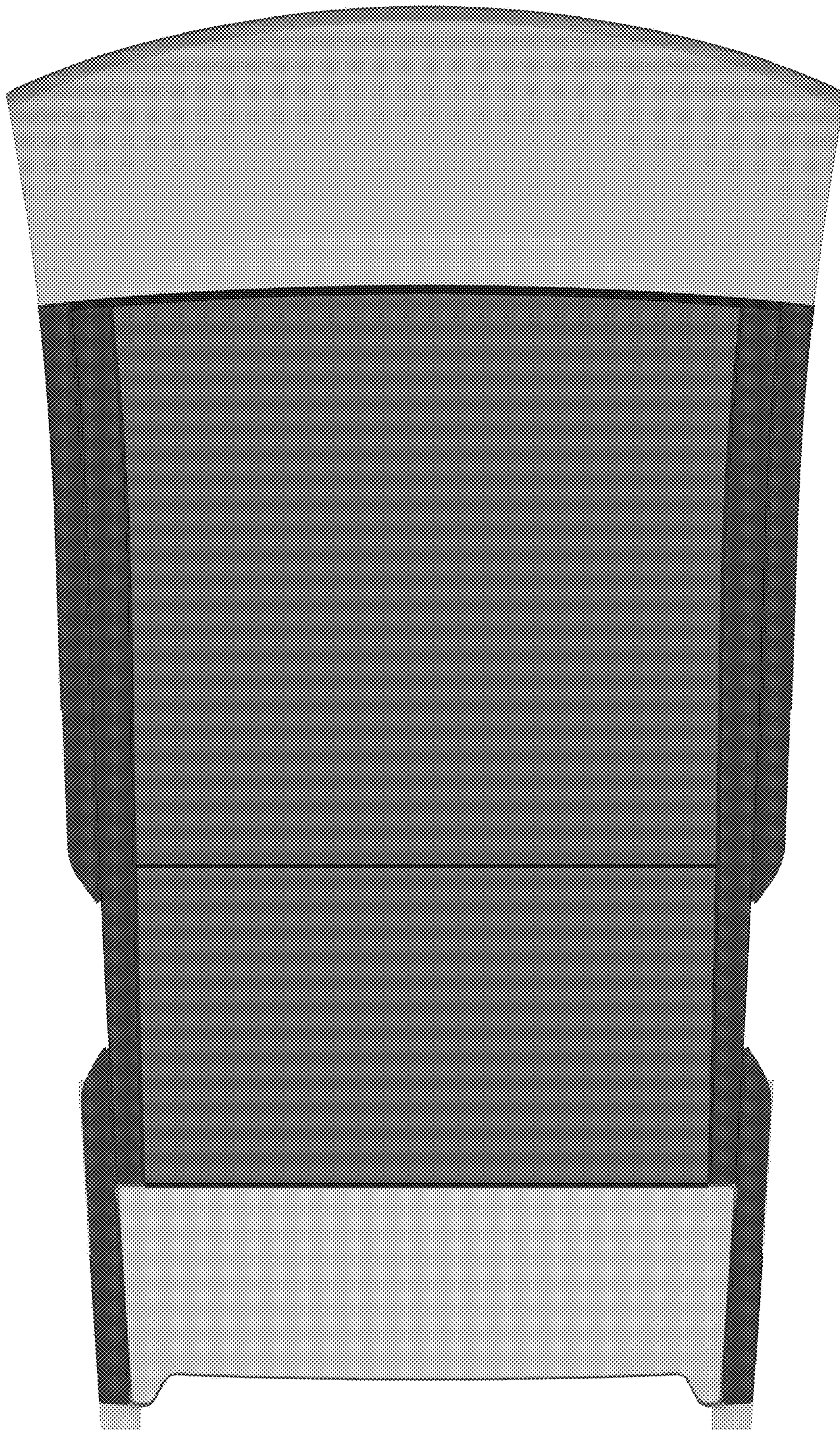

FIG. 42

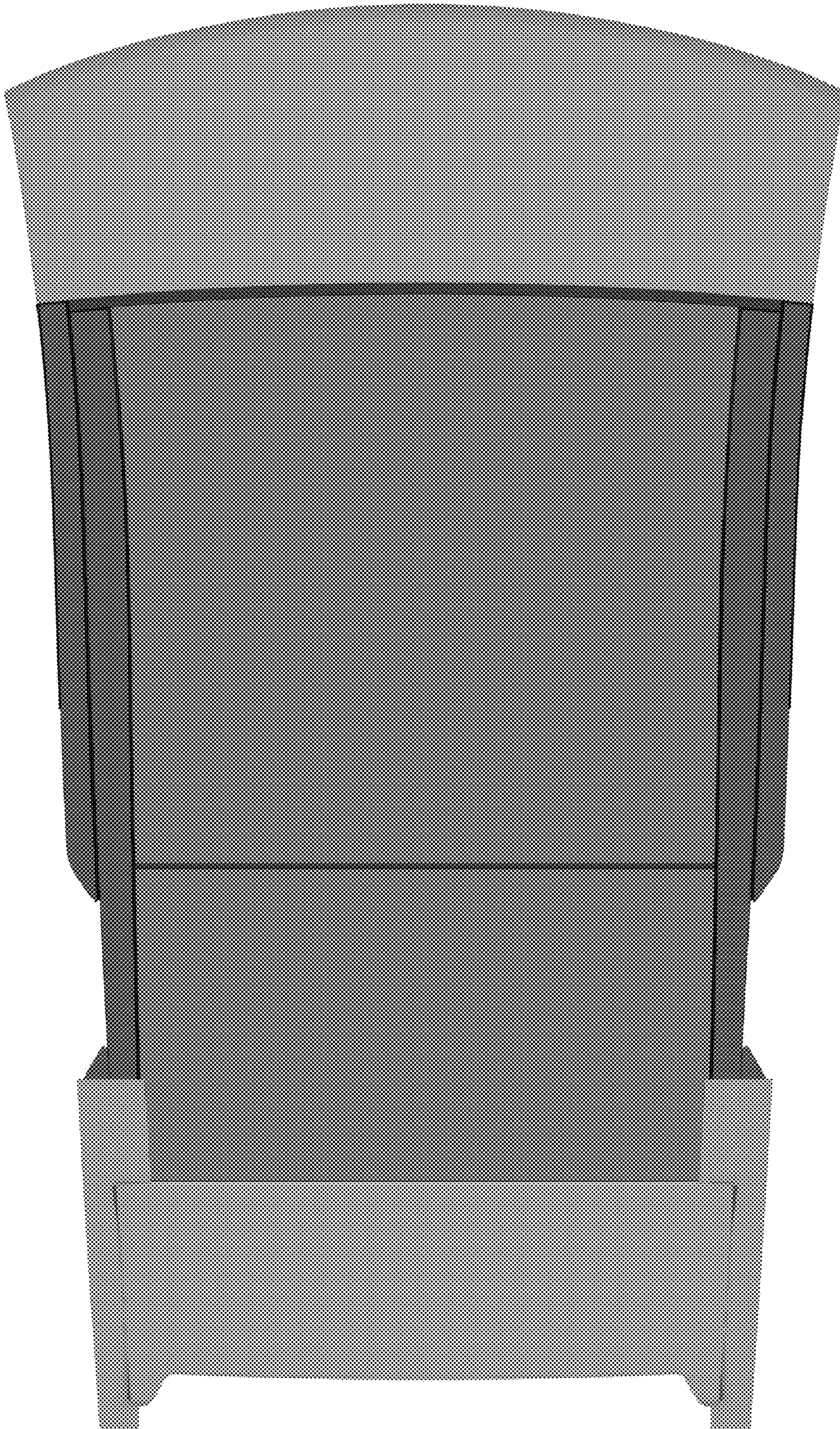

FIG. 43

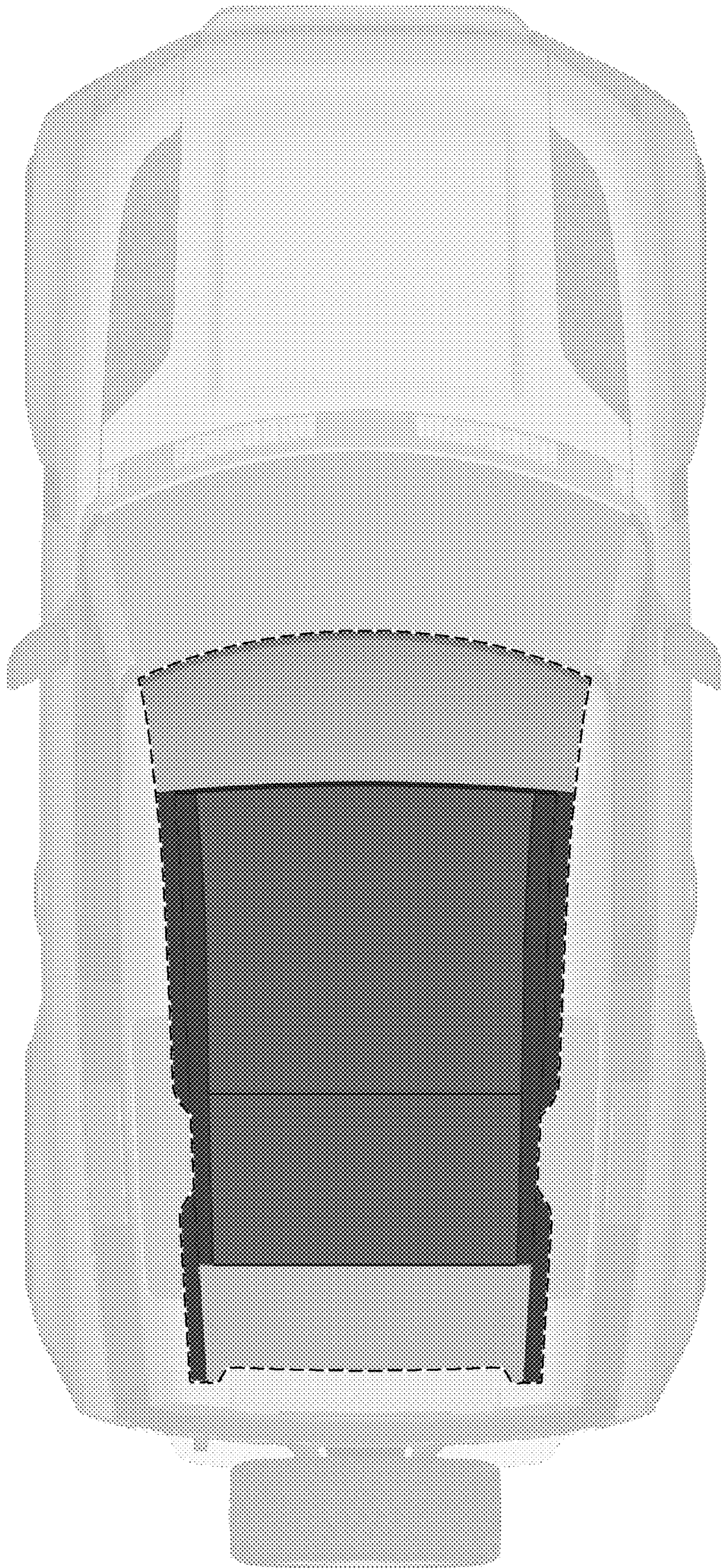

FIG. 44

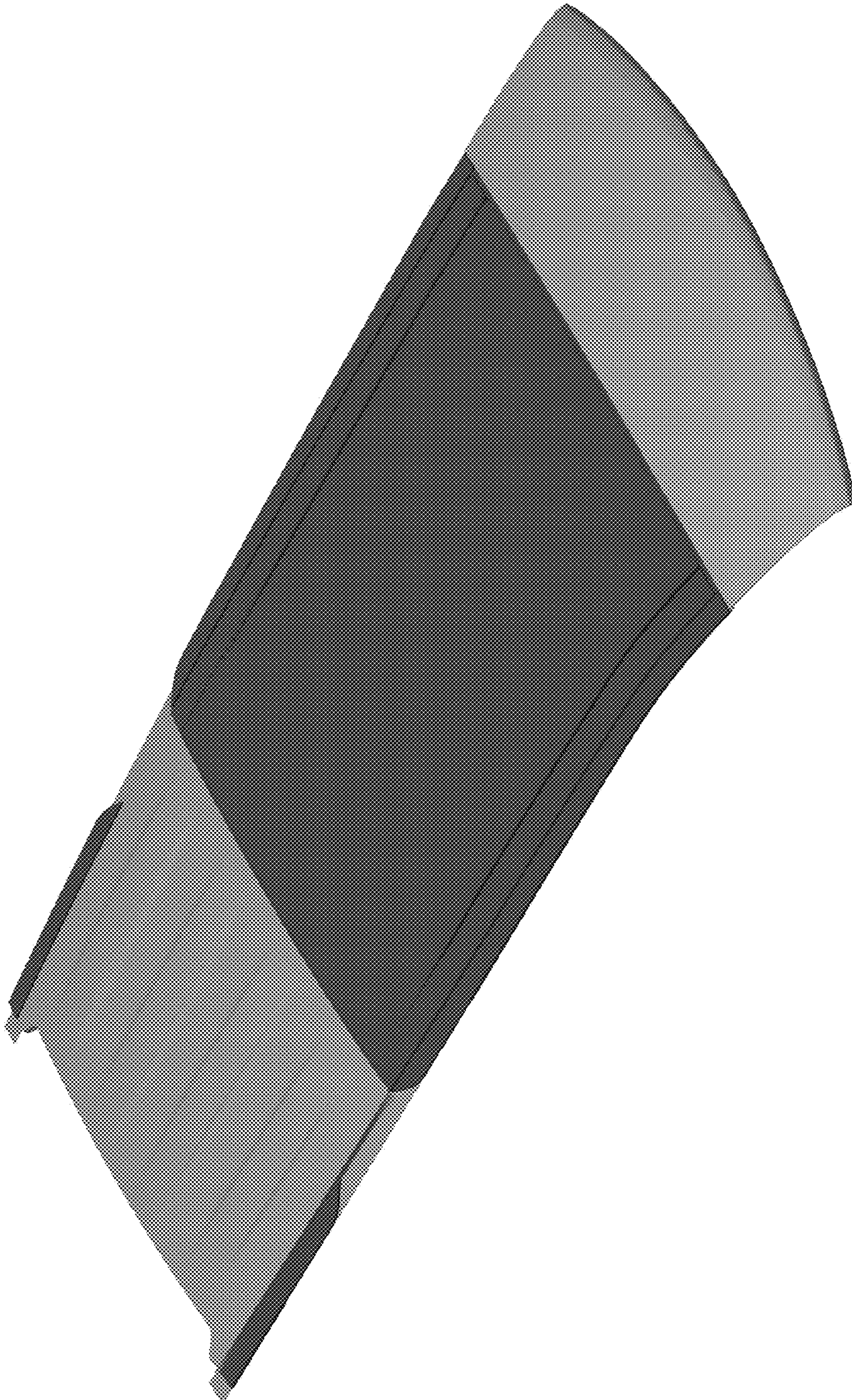

FIG. 45

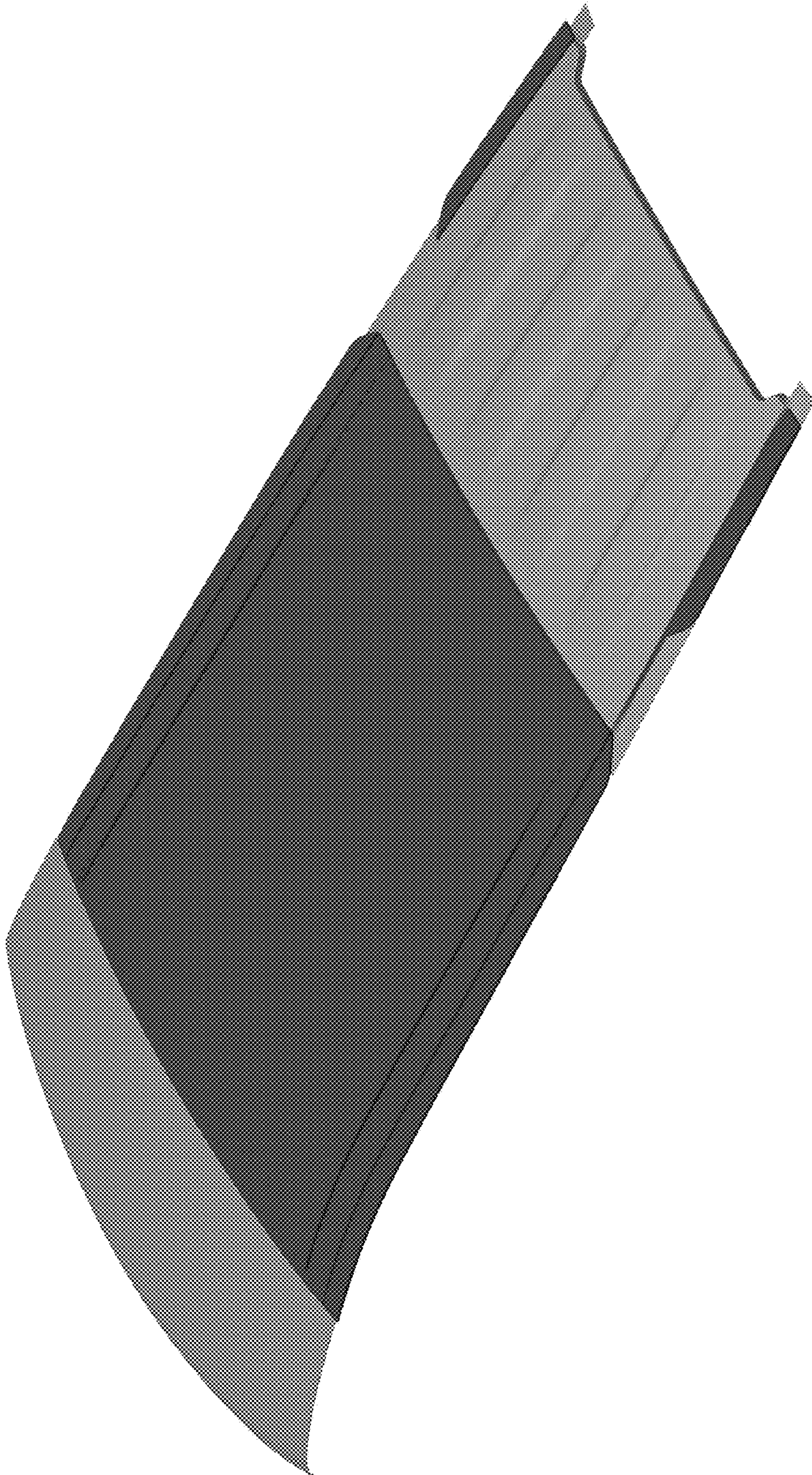

FIG. 46

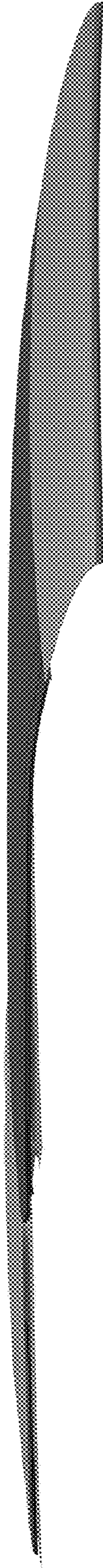

FIG. 47

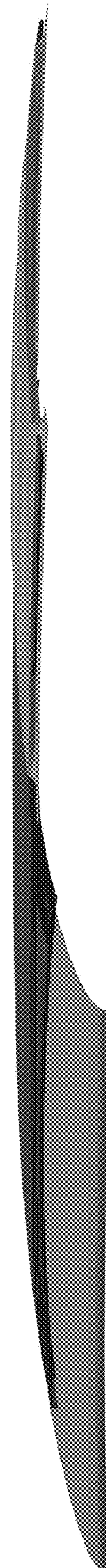

FIG. 48

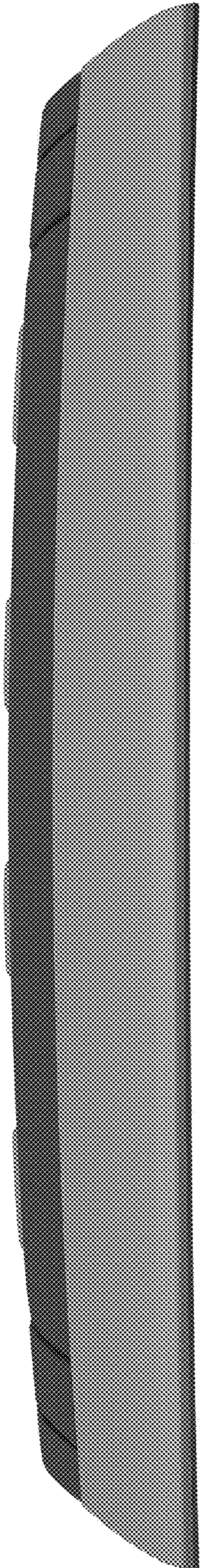

FIG. 49

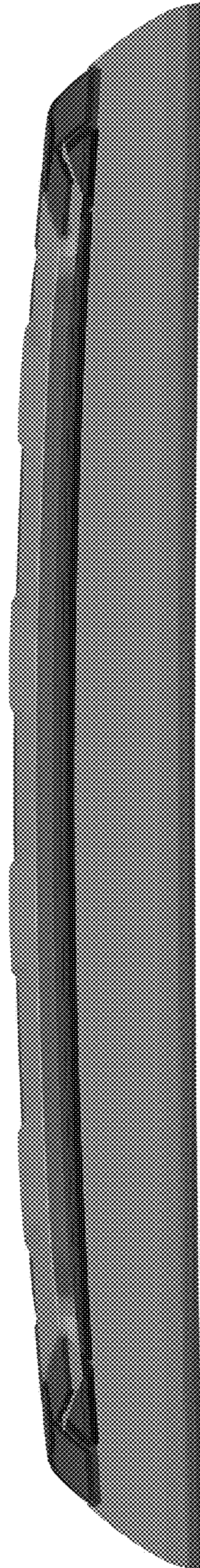

FIG. 50

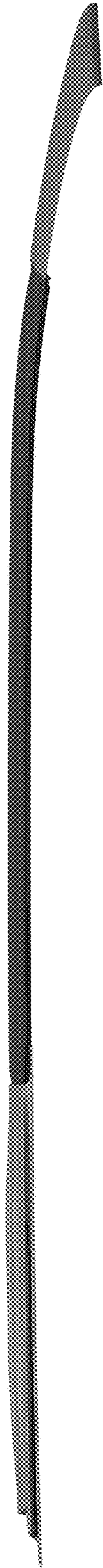

FIG. 51

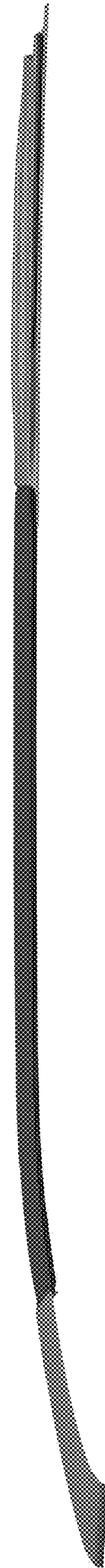

FIG. 52

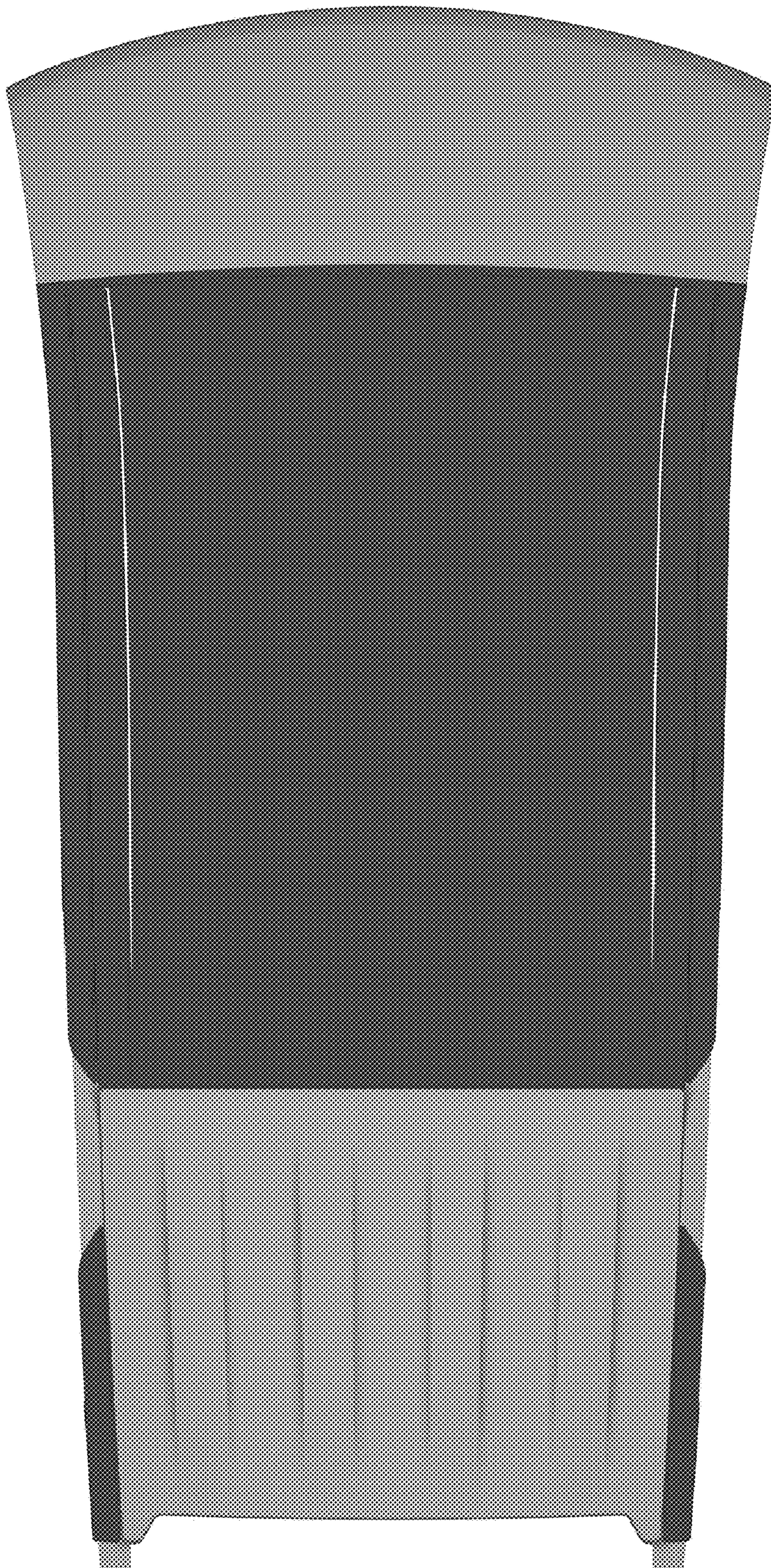

FIG. 53

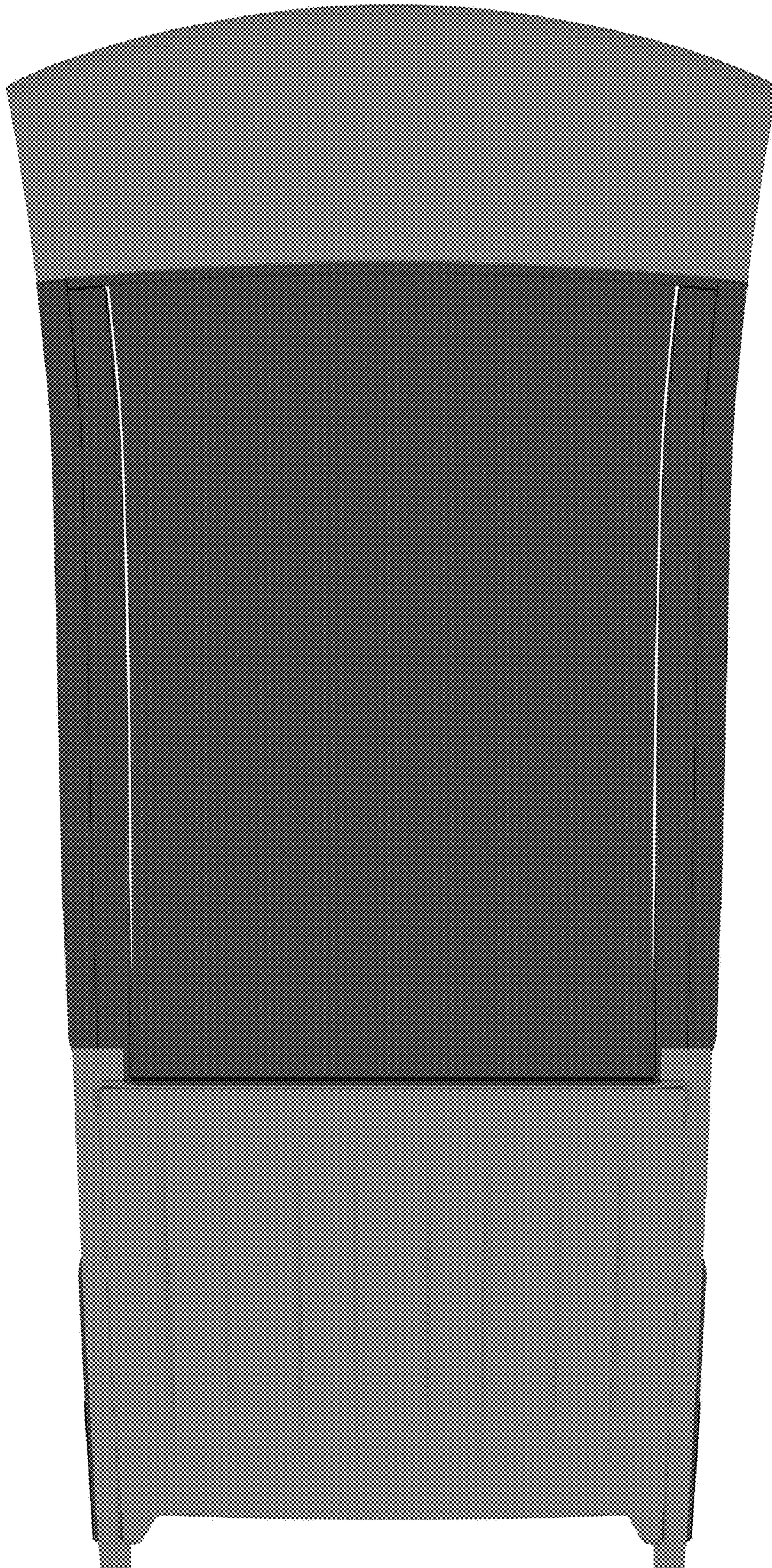

FIG. 54



FIG. 55

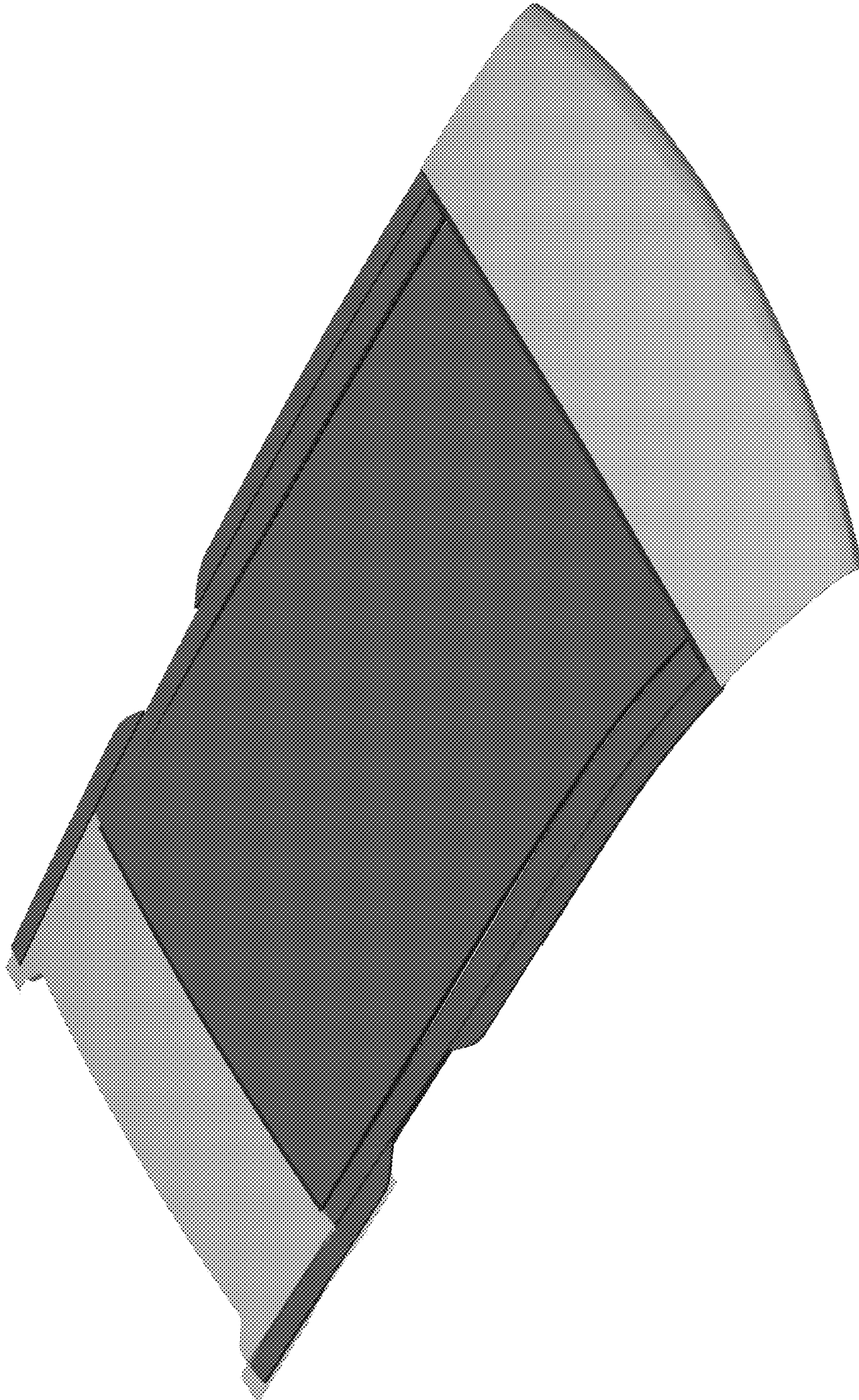

FIG. 56

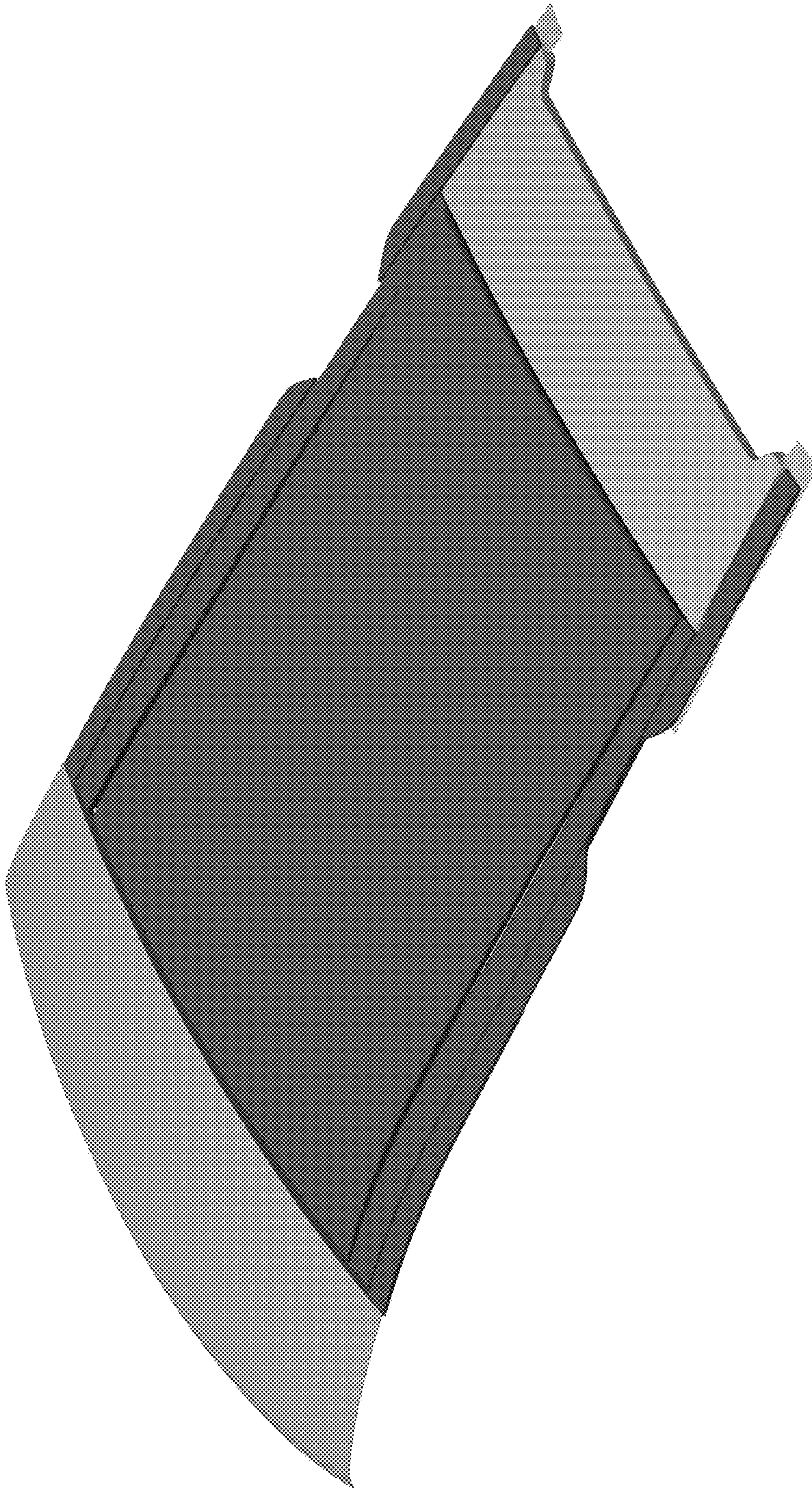

FIG. 57

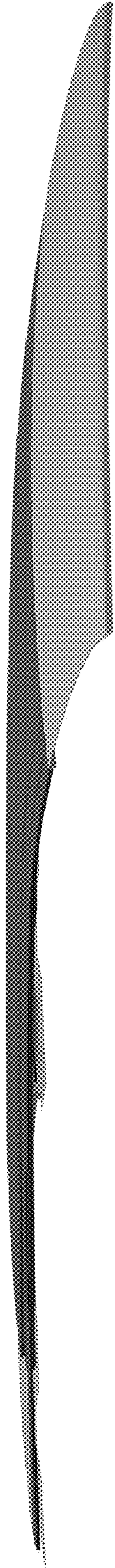

FIG. 58

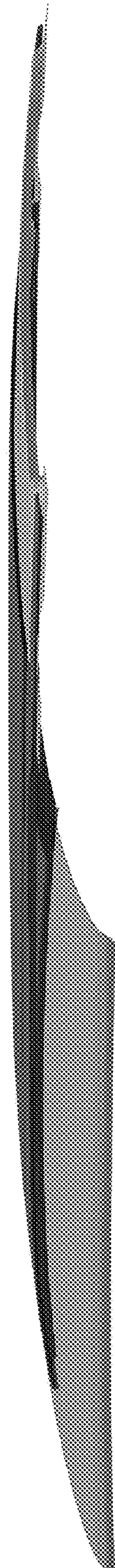

FIG. 59

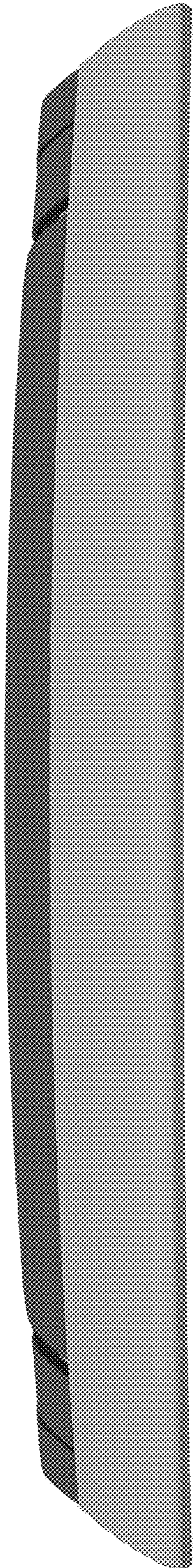

FIG. 60

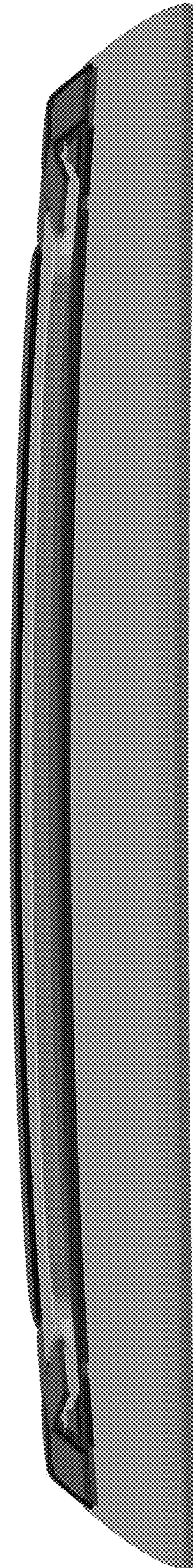

FIG. 61

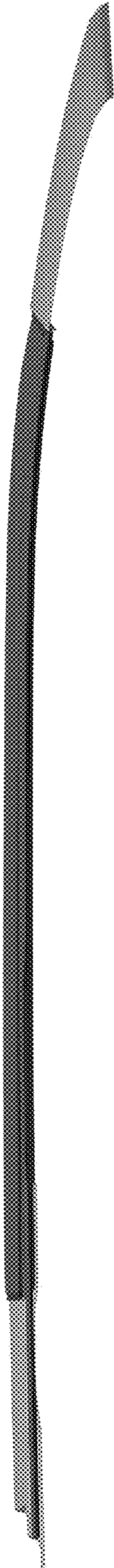

FIG. 62

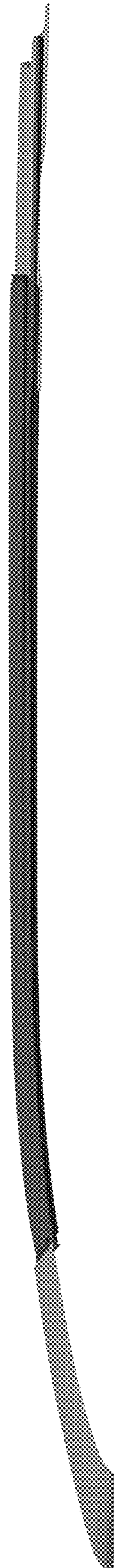

FIG. 63

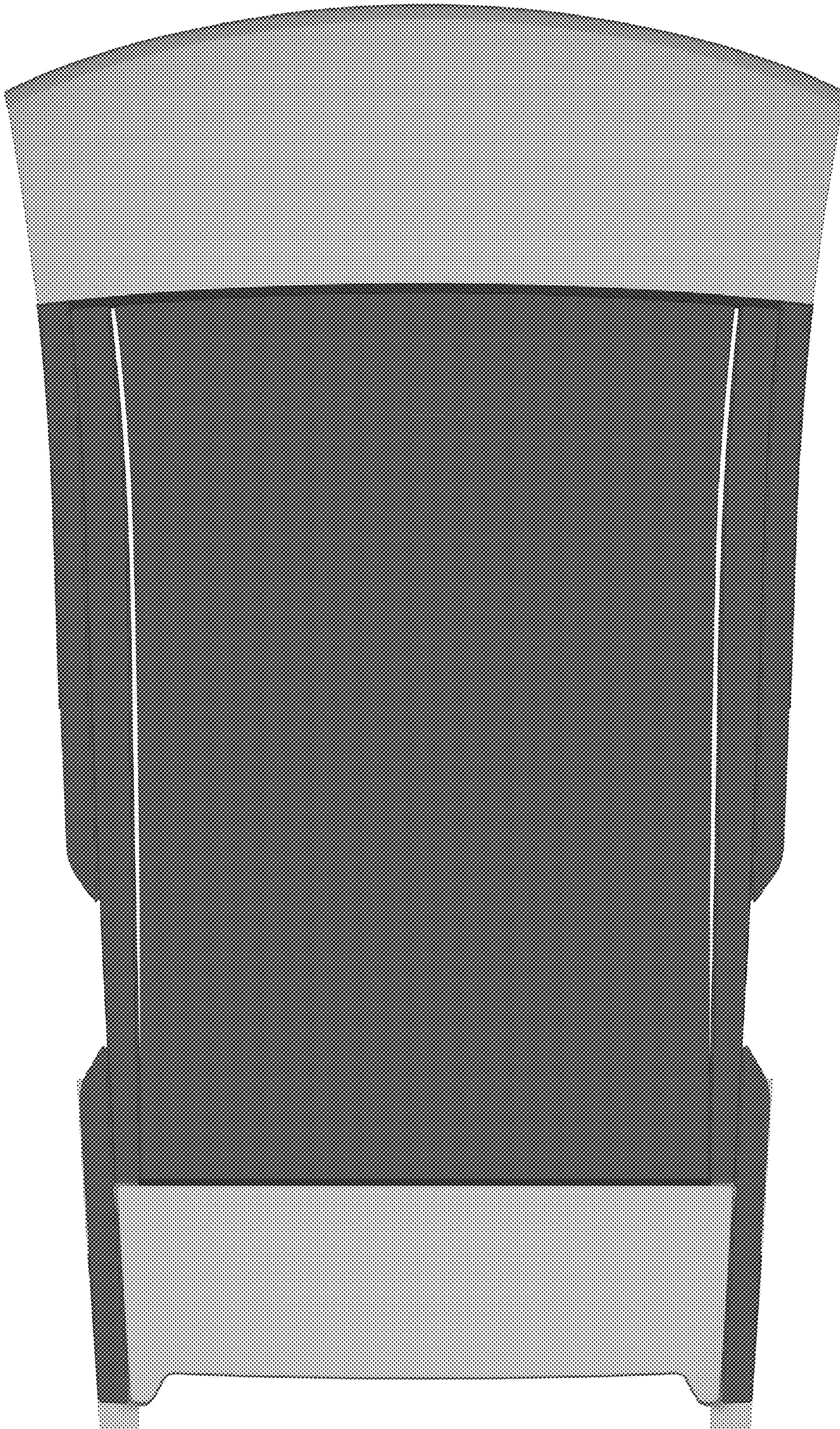

FIG. 64

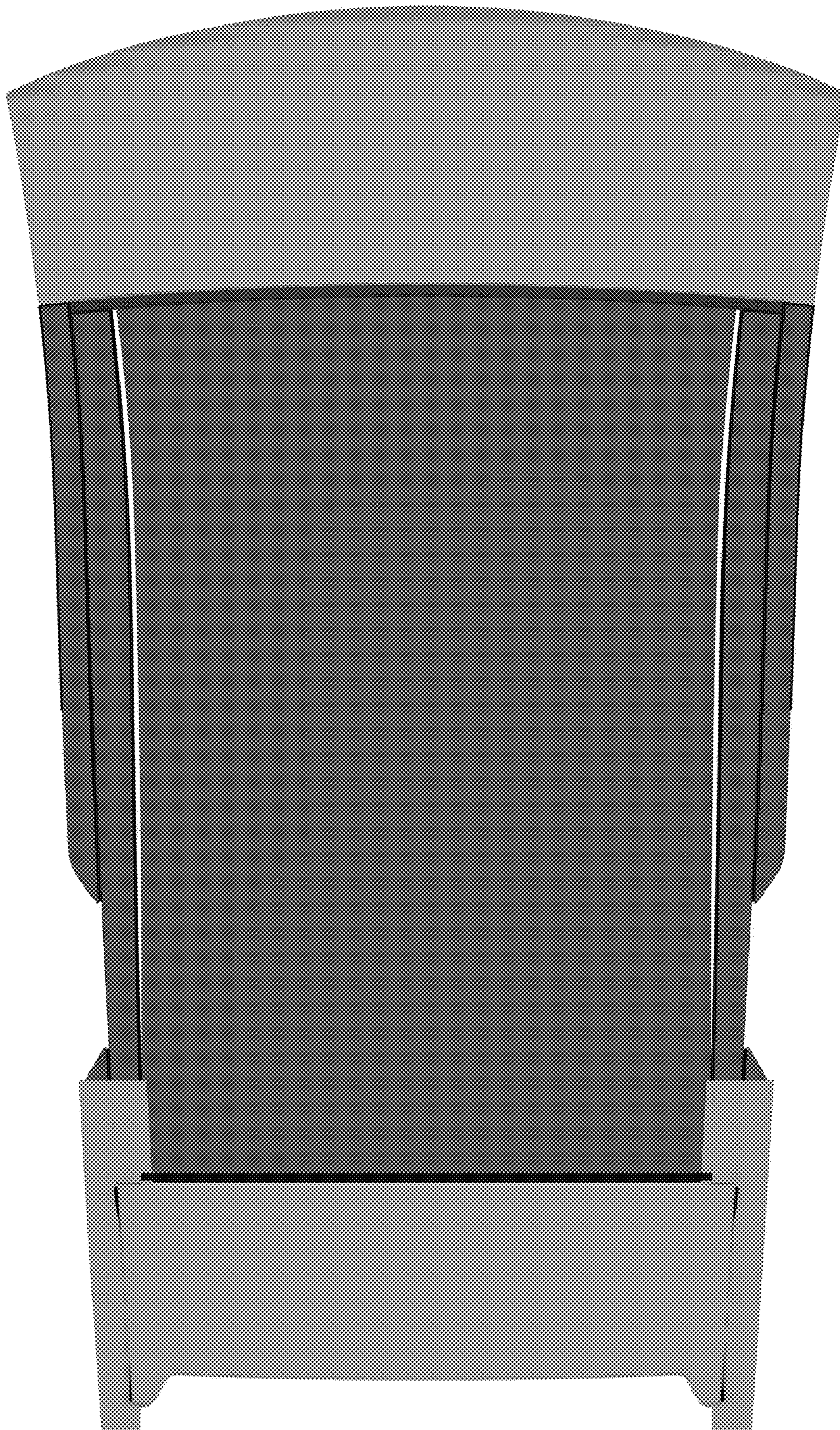

FIG. 65

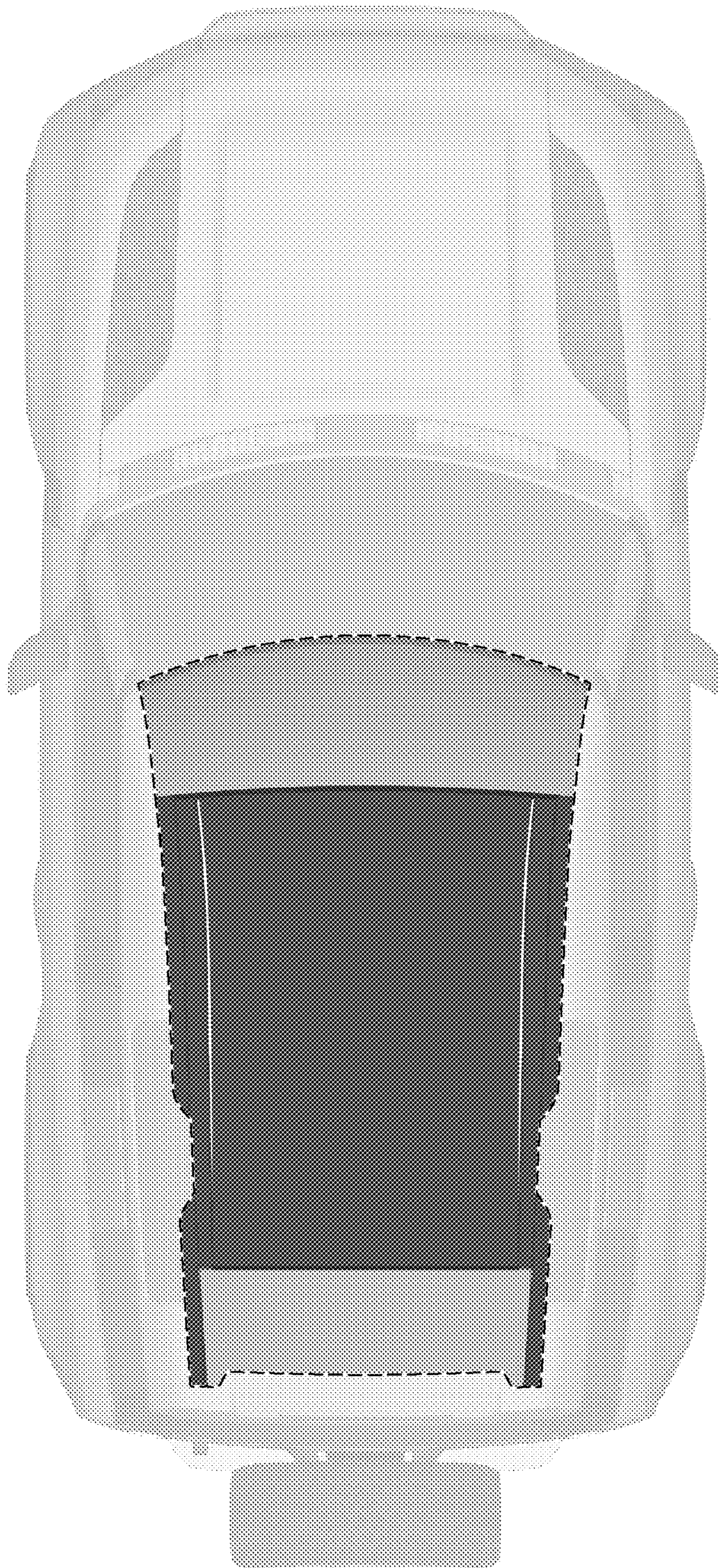

FIG. 66

UNITED STATES PATENT AND TRADEMARK OFFICE
CERTIFICATE OF CORRECTION

PATENT NO. : D873,203 S
APPLICATION NO. : 29/656108
DATED : January 21, 2020
INVENTOR(S) : Simon Grand

Page 1 of 1

It is certified that error appears in the above-identified patent and that said Letters Patent is hereby corrected as shown below:

On the Title Page

Column 2, Item (57), under "Description", Line 20, "FIG. 12 is a front left top perspective" should be ---FIG. 12 is a front left top perspective view---.

Column 2, Item (57), under "Description", Line 41, "FIG. 23 is a front left top perspective" should be ---FIG. 23 is a front left top perspective view---.

Column 1, page 2, Line 20, "FIG. 34 is a front left top perspective" should be ---FIG. 34 is a front left top perspective view---.

Column 1, page 2, Line 41, "FIG. 45 is a front left top perspective" should be ---FIG. 45 is a front left top perspective view---.

Column 2, page 2, Line 11, "FIG. 56 is a front left top perspective" should be ---FIG. 56 is a front left top perspective view---.

Signed and Sealed this
Fourteenth Day of April, 2020

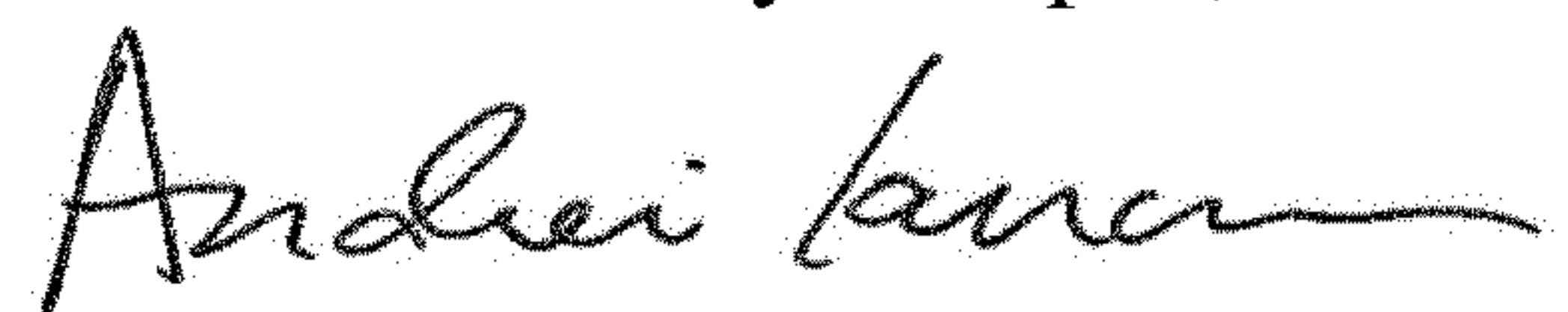

Andrei Iancu
Director of the United States Patent and Trademark Office