



US00D873176S

(12) **United States Design Patent**
Borkert

(10) **Patent No.:** **US D873,176 S**
(45) **Date of Patent:** **** Jan. 21, 2020**

(54) **CAR, TOY CAR REPLICA AND/OR OTHER REPLICA**

(71) Applicant: **AUTOMOBILI LAMBORGHINI S.P.A.**, Sant'Agata Bolognese (Bologna) (IT)

(72) Inventor: **Mitja Borkert**, Castelnuovo Rangone (IT)

(73) Assignee: **Automobili Lamborghini S.p.A.**, Sant'Agata Bolognese (IT)

(**) Term: **15 Years**

(21) Appl. No.: **29/659,386**

(22) Filed: **Aug. 8, 2018**

(30) **Foreign Application Priority Data**

Mar. 5, 2018 (EM) 004739811-0001

(51) **LOC (12) Cl.** **12-08**

(52) **U.S. Cl.**
USPC **D12/88**

(58) **Field of Classification Search**
USPC D12/86, 90-92, 88; D21/424, 433, 434, D21/533; 296/181.1-181.5, 183.1
CPC B62D 25/00; B62D 25/06; B62D 33/00; B62D 35/00

See application file for complete search history.

(56) **References Cited**

U.S. PATENT DOCUMENTS

D769,152 S * 10/2016 Perini D12/88
D781,749 S * 3/2017 Perini D12/88
D788,642 S * 6/2017 Manzoni D12/88
D790,398 S * 6/2017 Perini D12/88

(Continued)

FOREIGN PATENT DOCUMENTS

JP 1520547 3/2015
JP 1520650 3/2015

(Continued)

OTHER PUBLICATIONS

Japanese Search Report dated Feb. 19, 2019 for counterpart Japanese Patent Application No. 2018-017493.

(Continued)

Primary Examiner — Melody N Brown

(74) *Attorney, Agent, or Firm* — Shuttleworth & Ingersoll, PLC; Timothy Klima

(57) **CLAIM**

The ornamental design for a car, including toy car, motor car, replica car and scale model car, as shown and described.

DESCRIPTION

FIG. 1 is a top, front and left side perspective view of a car, toy car replica and/or other replica showing my new design; FIG. 2 is a top, rear and left side perspective view thereof; FIG. 3 is a top view thereof; FIG. 4 is a front view thereof; FIG. 5 is a rear view thereof; FIG. 6 is a left side view thereof; FIG. 7 is a right side view thereof; FIG. 8 is a bottom view thereof; FIG. 9 is a top, front and left side perspective view of car, toy car replica and/or other replica showing a second embodiment of my new design; FIG. 10 is a top, rear and left side perspective view thereof; FIG. 11 is left side view thereof; and, FIG. 12 is a right side view thereof.

The broken lines in the figures illustrate portions of the car that form no part of the claimed design.

1 Claim, 12 Drawing Sheets

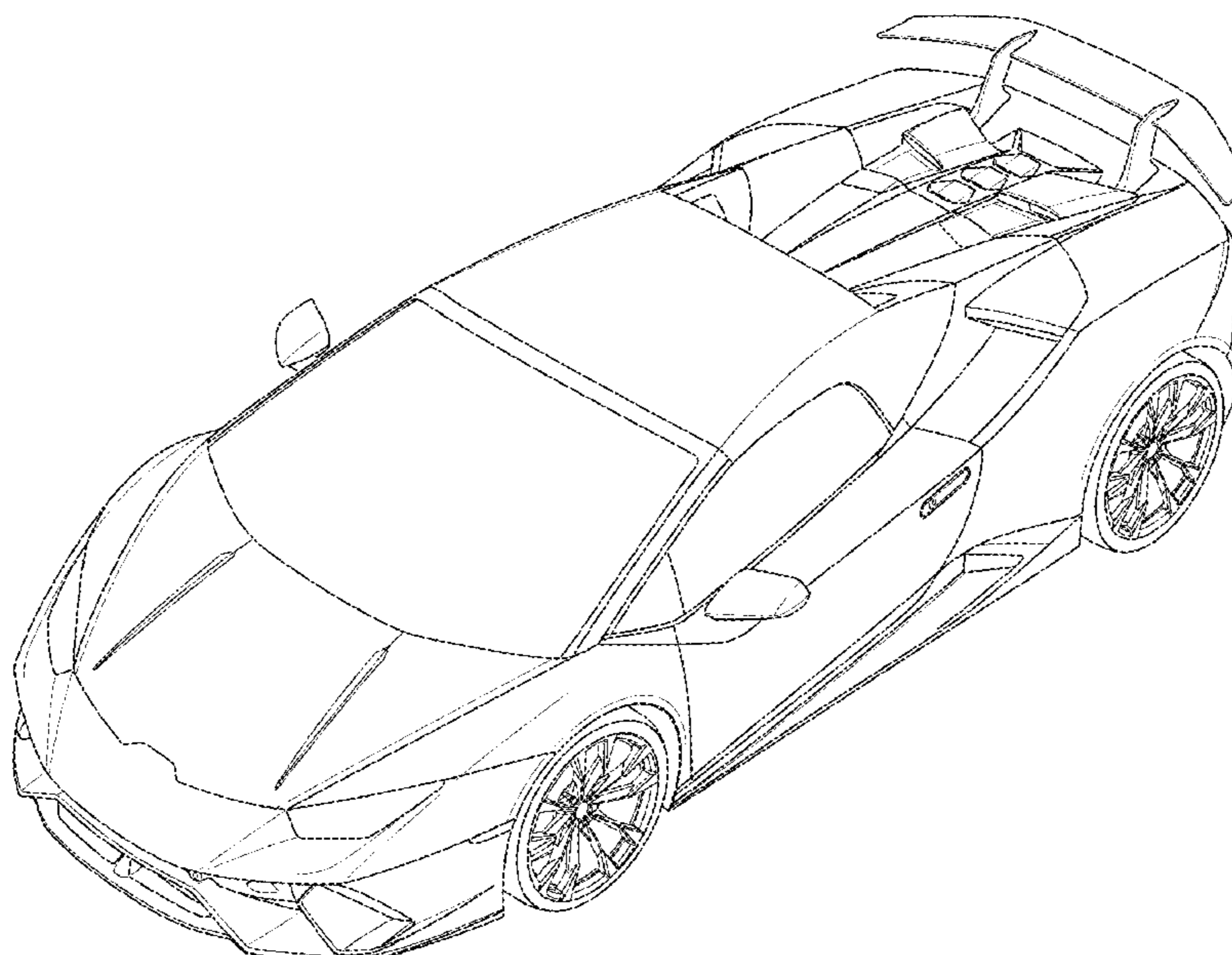

(56)

References Cited

U.S. PATENT DOCUMENTS

| | | | | |
|------------|---|---------|---------------|--------|
| D790,399 S | * | 6/2017 | Perini | D12/88 |
| D790,402 S | * | 6/2017 | Perini | D12/88 |
| D791,019 S | * | 7/2017 | Perini | D12/88 |
| D833,912 S | * | 11/2018 | Manzoni | D12/88 |

FOREIGN PATENT DOCUMENTS

| | | |
|----|----------|---------|
| JP | 1555011 | 8/2016 |
| JP | 1556617 | 8/2016 |
| JP | 1577714 | 5/2017 |
| JP | 1446625 | 7/2017 |
| JP | 1581748 | 7/2017 |
| JP | 1581749 | 7/2017 |
| JP | 1584928 | 8/2017 |
| JP | 1587377 | 10/2017 |
| JP | 1590960 | 11/2017 |
| WO | DM097124 | 3/2017 |
| WO | DM097125 | 3/2017 |

OTHER PUBLICATIONS

Japanese Search Report dated Feb. 22, 2019 for counterpart Japanese Patent Application No. 2018-017494.

* cited by examiner

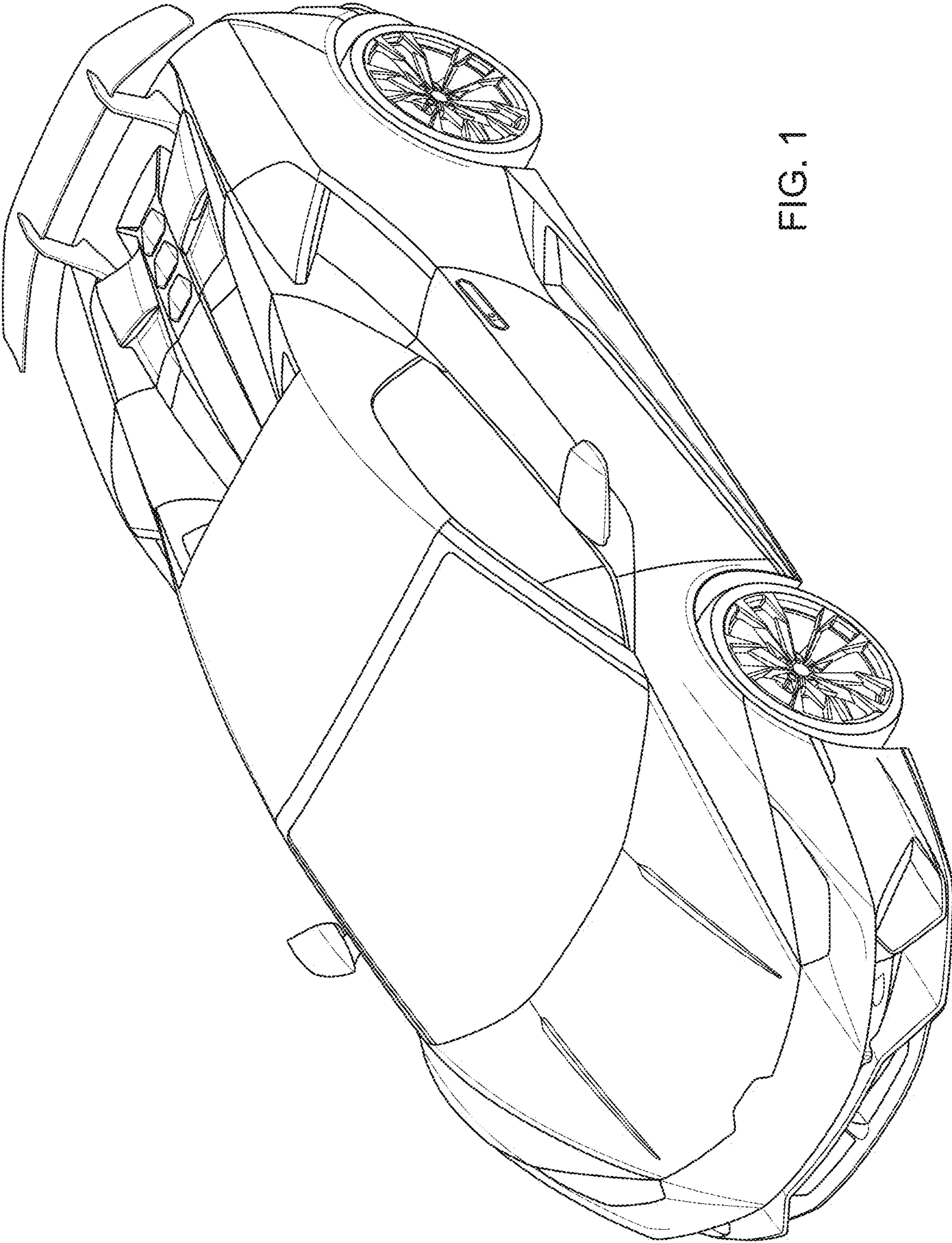

FIG. 1

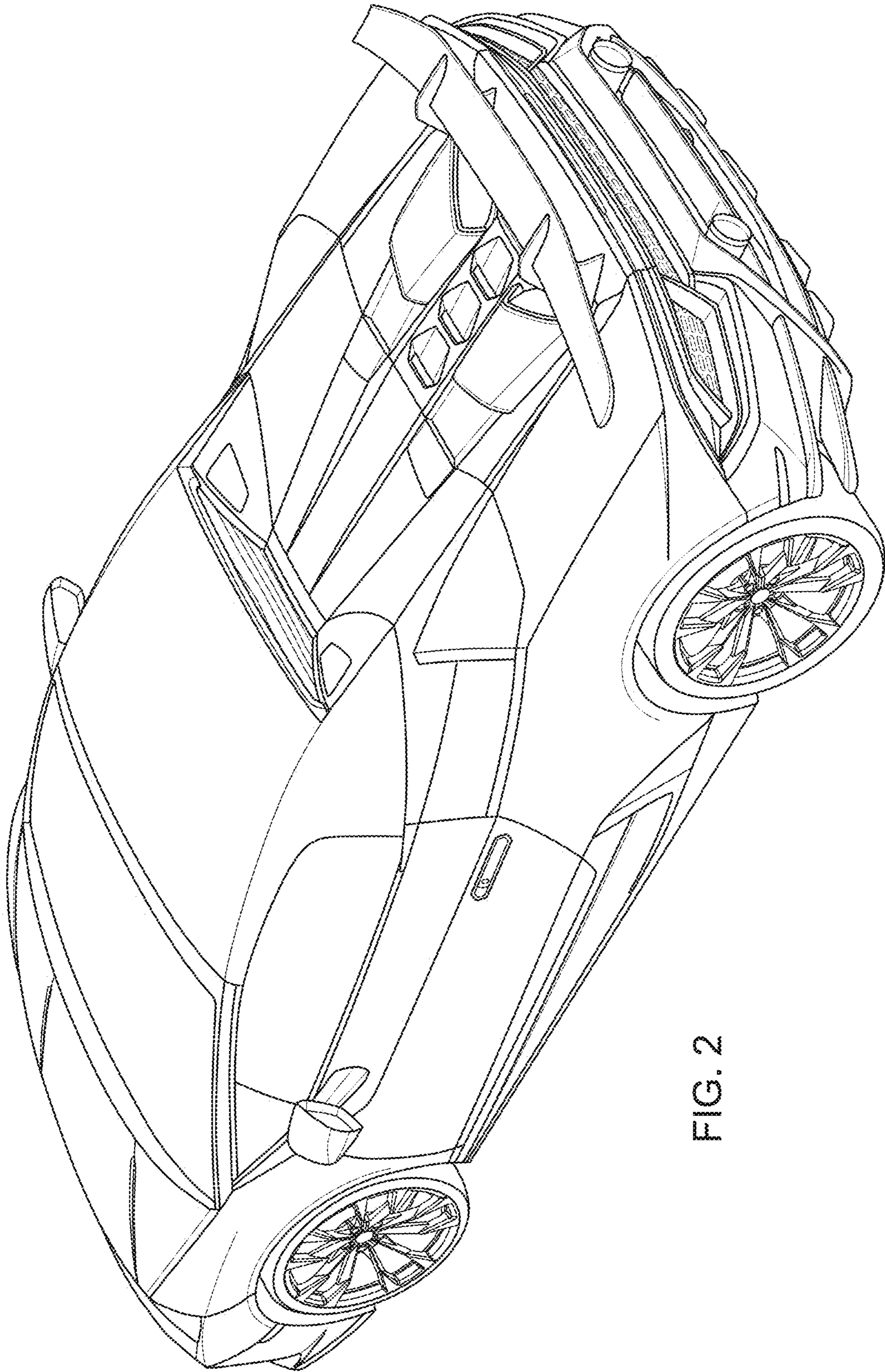

FIG. 2

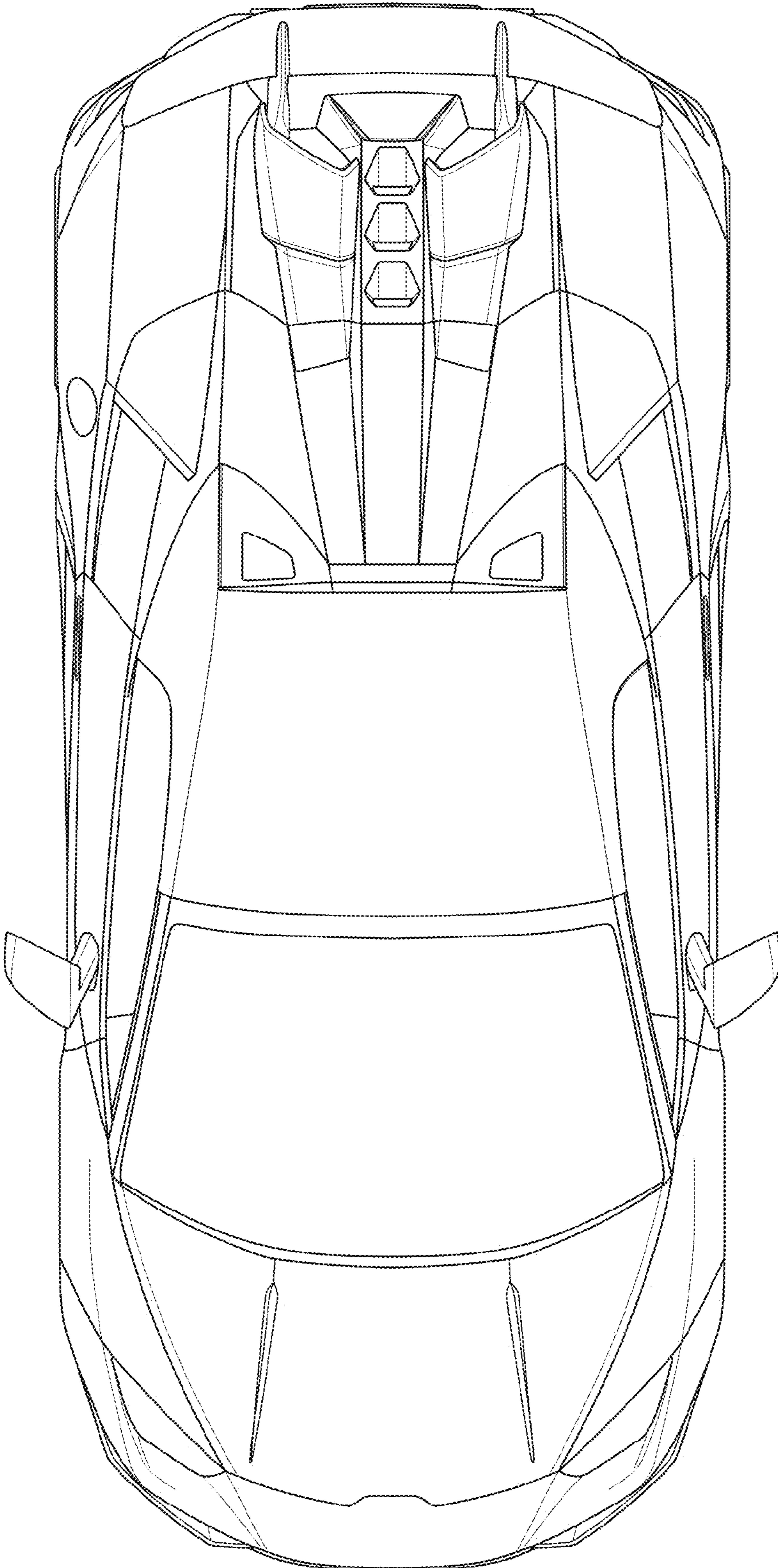

FIG. 3

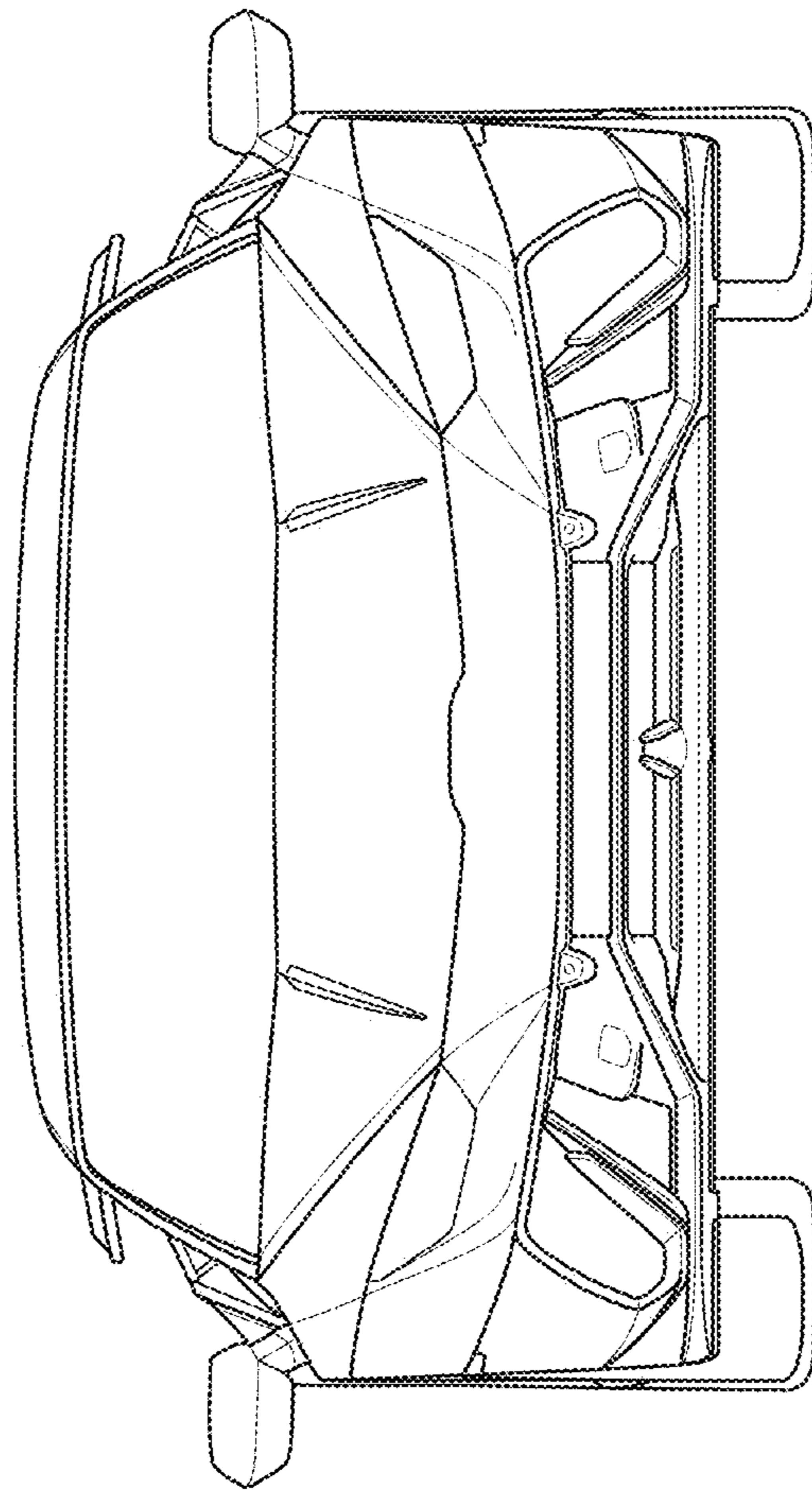

FIG. 4

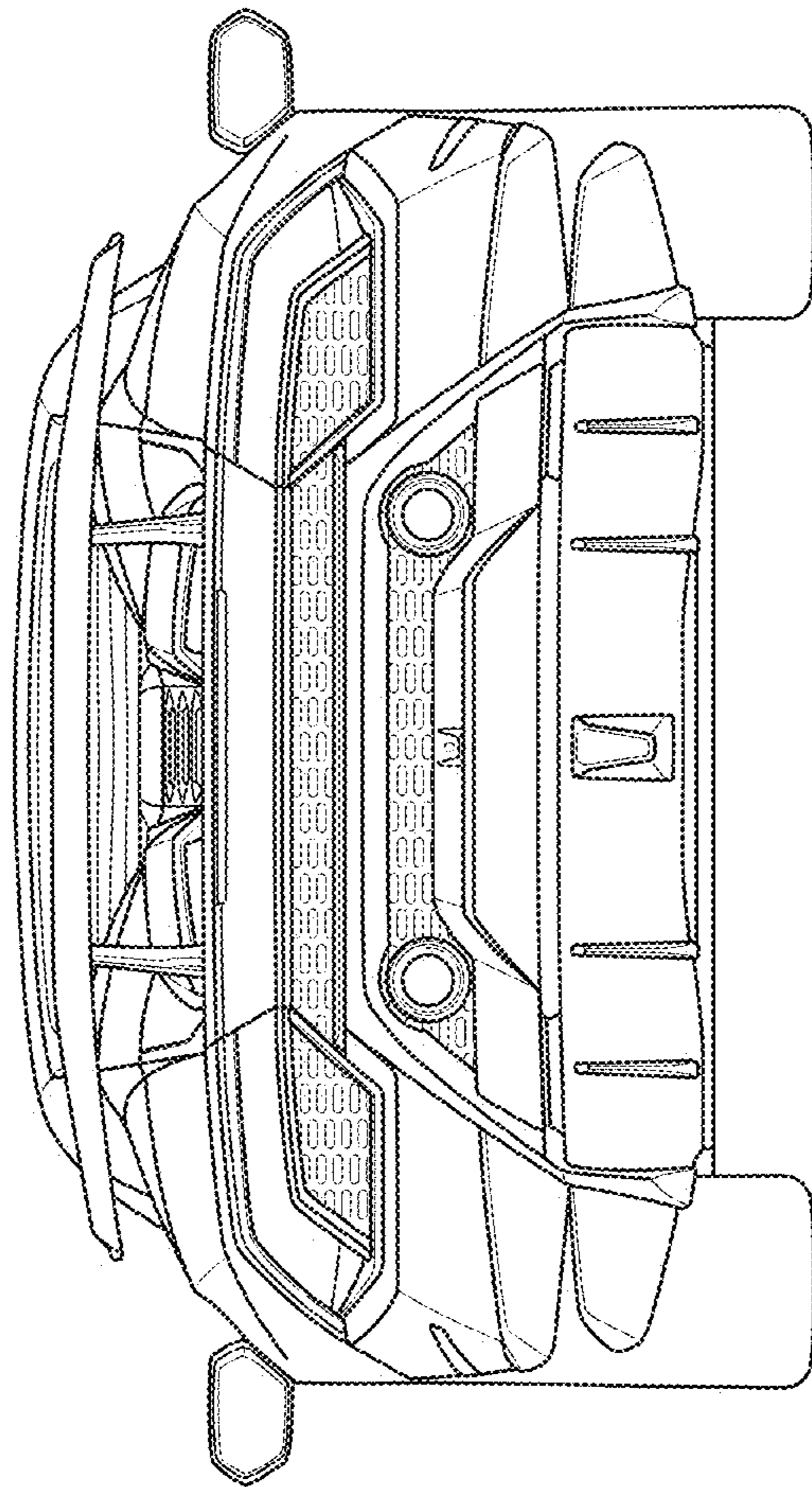

FIG. 5

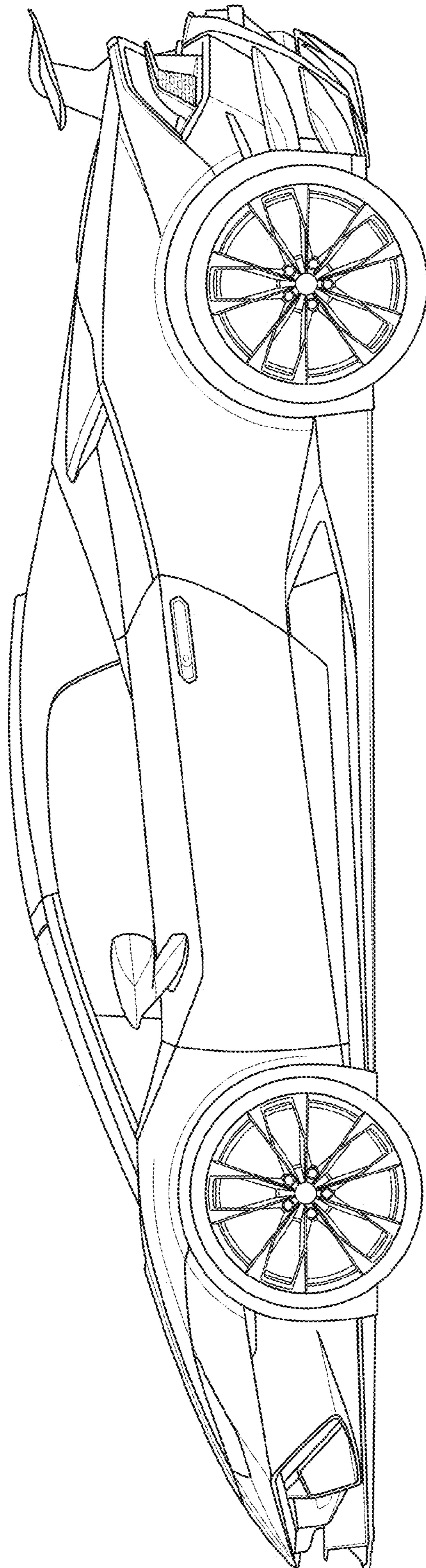

FIG. 6

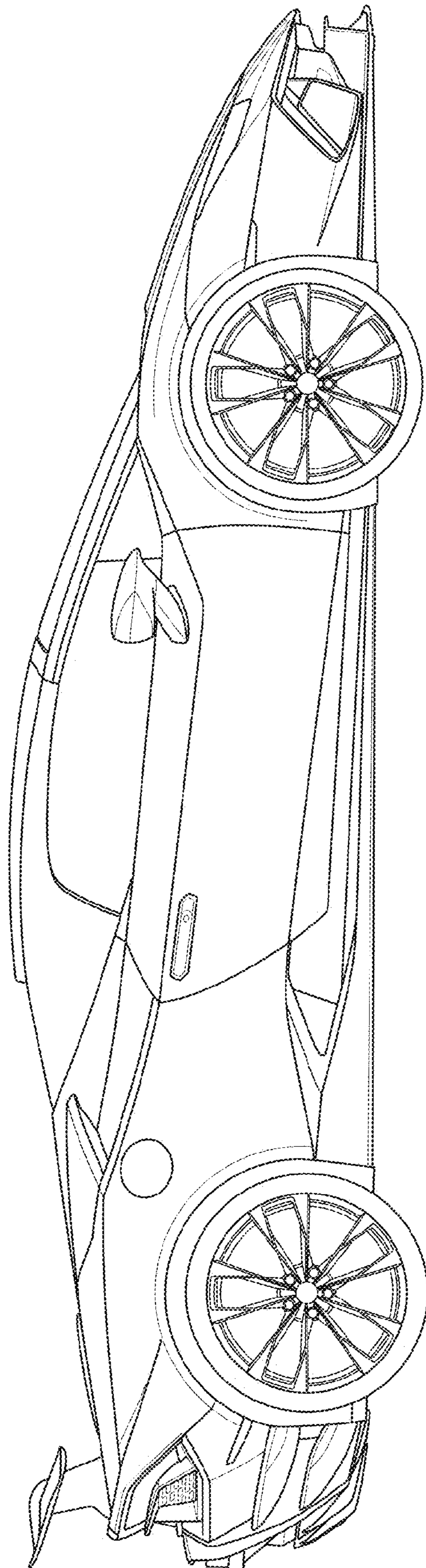

FIG. 7

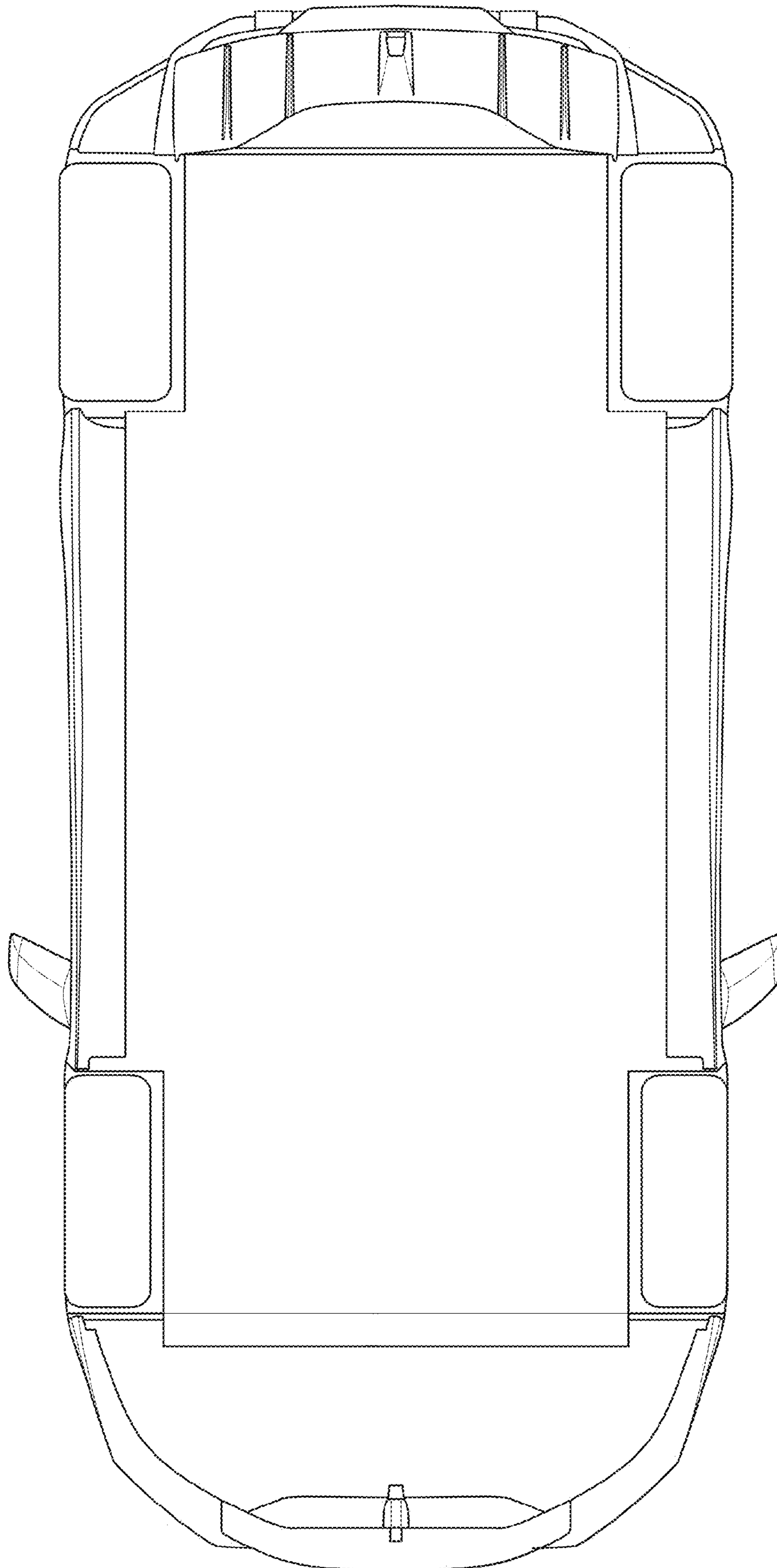

FIG. 8

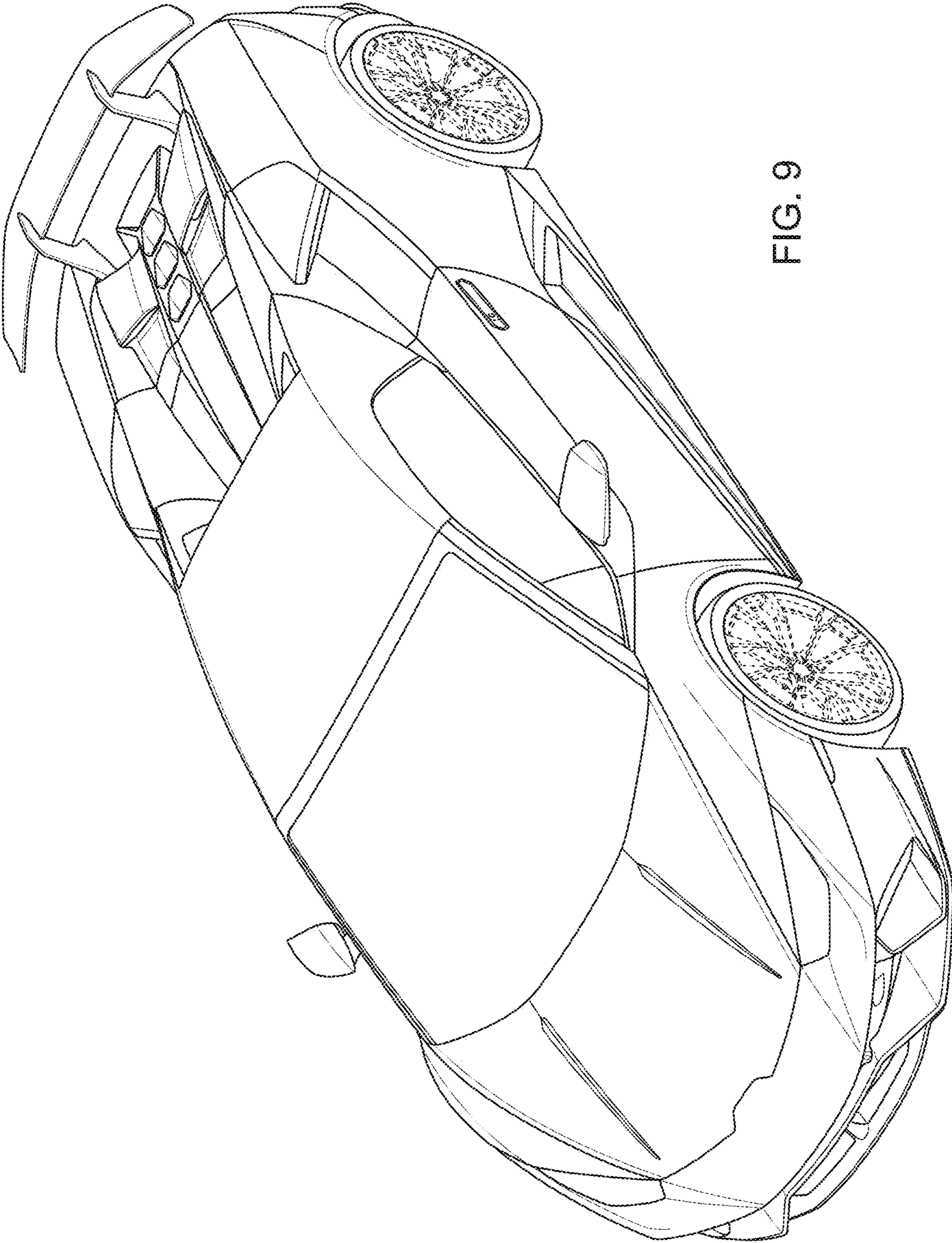

FIG. 9

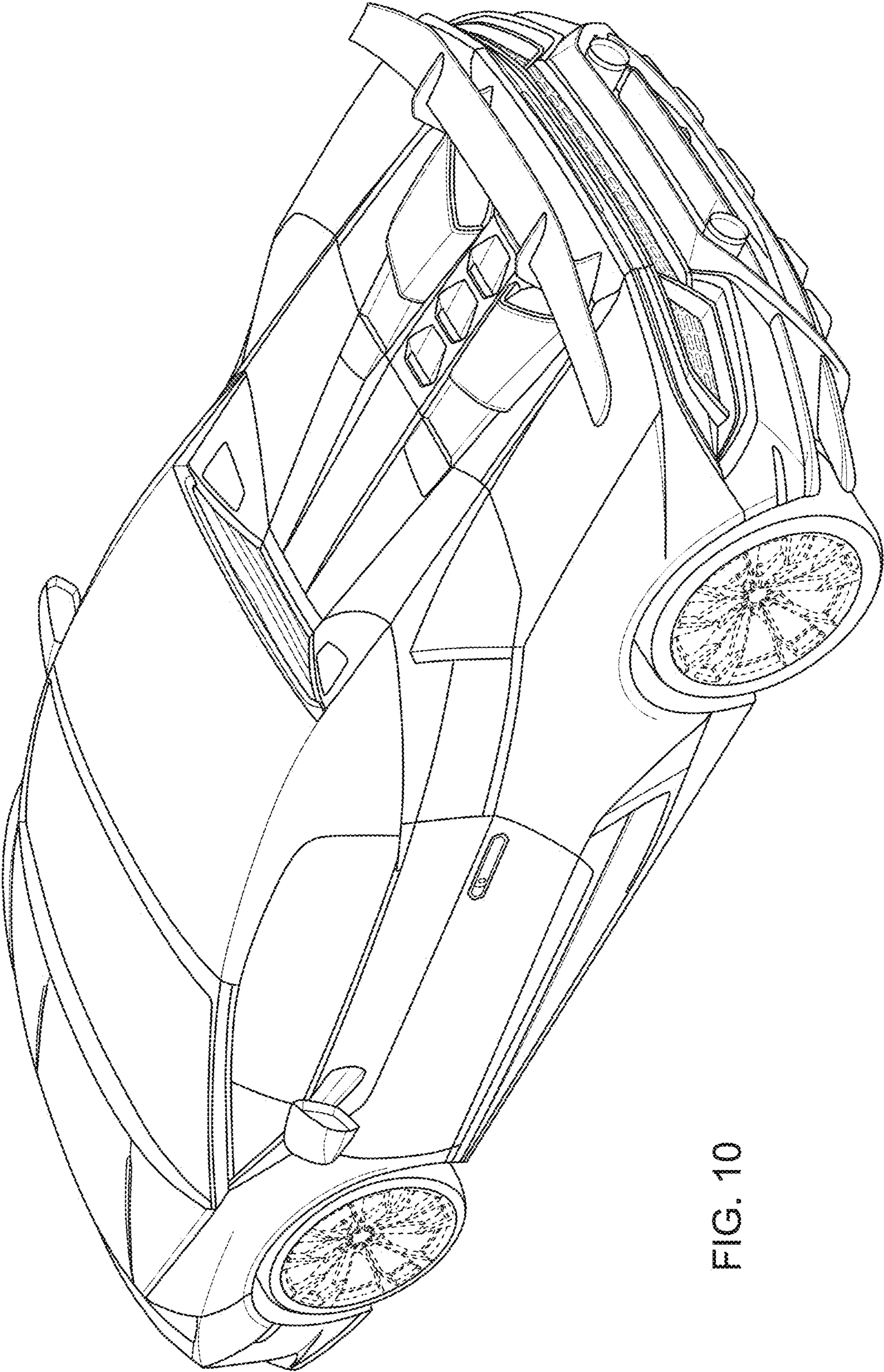

FIG. 10

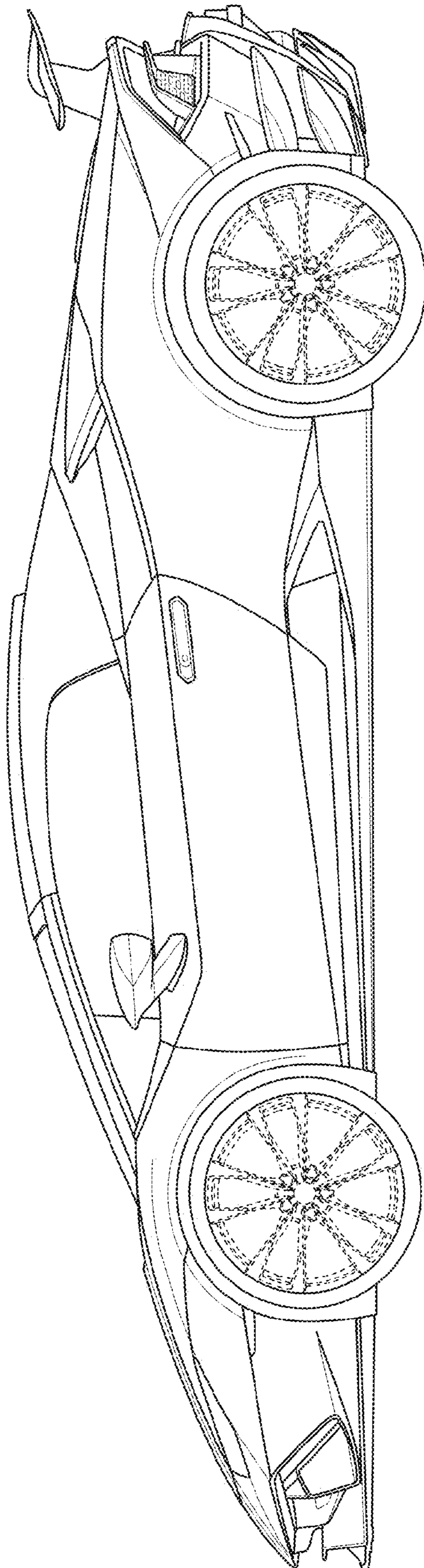

FIG. 11

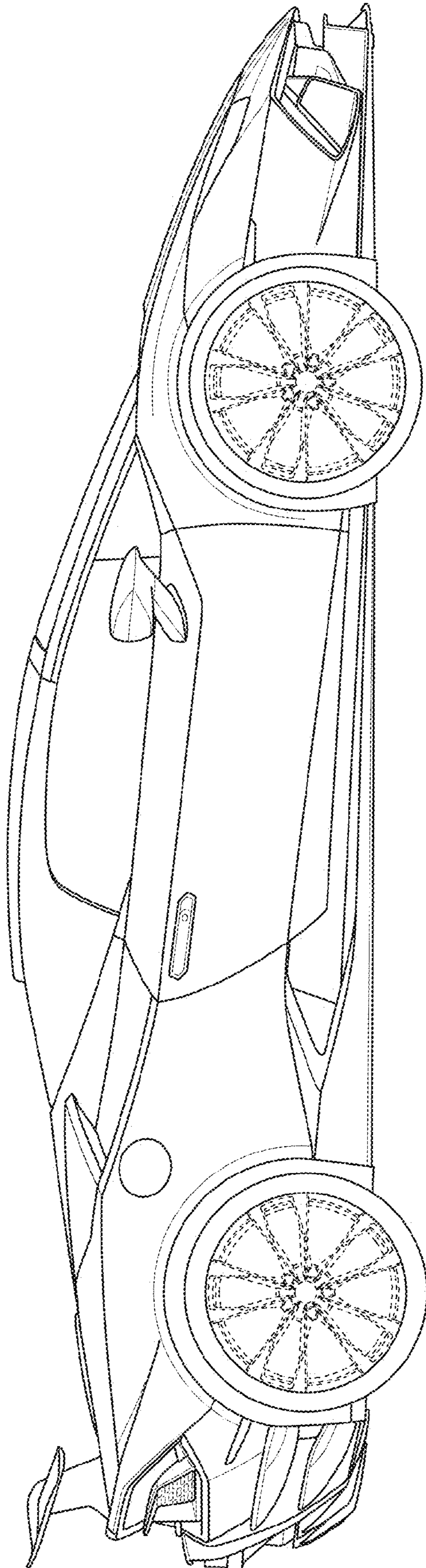

FIG. 12