



US00D873161S

(12) **United States Design Patent**
Nasu et al.

(10) **Patent No.:** **US D873,161 S**
(45) **Date of Patent:** **** Jan. 21, 2020**

- (54) **ELECTRIC CONTACT**
- (71) Applicant: **Kabushiki Kaisha Nihon Micronics,**
Tokyo (JP)
- (72) Inventors: **Mika Nasu,** Tokyo (JP); **Tsuyoshi**
Muramoto, Tokyo (JP)
- (73) Assignee: **Kabushiki Kaisha Nihon Micronics,**
Tokyo (JP)
- (**) Term: **15 Years**
- (21) Appl. No.: **29/658,648**
- (22) Filed: **Aug. 1, 2018**
- (30) **Foreign Application Priority Data**

Feb. 2, 2018 (JP) 2018-002096

- (51) **LOC (12) Cl.** **10-04**
- (52) **U.S. Cl.**
USPC **D10/78**
- (58) **Field of Classification Search**
USPC D10/78, 80
CPC G01R 1/06; G01R 1/067; G01R 1/06772;
G01R 1/06777; G01R 1/06783; G01R
1/06788; G01R 29/0878
See application file for complete search history.

(56) **References Cited**

U.S. PATENT DOCUMENTS

- 4,634,968 A * 1/1987 Aslan G01R 21/10
324/119
- 4,716,365 A * 12/1987 Pool G01R 1/06788
324/72.5
- 4,740,746 A * 4/1988 Pollock G01R 1/06722
324/754.06
- D311,346 S * 10/1990 Gross D10/80

- 5,172,051 A * 12/1992 Zamborelli G01R 1/06772
324/149
- D397,052 S * 8/1998 Arnoux D10/80
- 7,208,971 B2 * 4/2007 Lee G01N 27/83
324/750.25

(Continued)

FOREIGN PATENT DOCUMENTS

- JP D763334 5/1989
- KR 2004455650000 8/2009

(Continued)

Primary Examiner — Antoine Duval Davis

(74) *Attorney, Agent, or Firm* — Lorenz & Kopf, LLP

(57) **CLAIM**

The ornamental design for an electric contact, as shown and described.

DESCRIPTION

FIG. 1 is a perspective view of a portion of an electric contact, showing the claimed design;
 FIG. 2 is a front elevation view of the electric contact;
 FIG. 3 is a rear elevation view of the electric contact;
 FIG. 4 is a left side elevation view of the electric contact;
 FIG. 5 is a right side elevation view of the electric contact;
 FIG. 6 is a top plan view of the electric contact;
 FIG. 7 is a bottom plan view of the electric contact;
 FIG. 8 is an enlarged view of the section of the electric contact as indicated in FIG. 2;
 FIG. 9 is an enlarged left side view of the section of the electric contact as indicated in FIG. 2; and,
 FIG. 10 is an enlarged right side view of the section of the electric contact as indicated in FIG. 2.

The broken lines shown in the figures are only for the purpose of illustrating the unclaimed portions of the article, and form no part of the claimed design. Chain or line-dot broken lines indicate boundary lines between the claimed portions and the unclaimed portions, and are for illustration only and form no part of the claimed design.

1 Claim, 4 Drawing Sheets

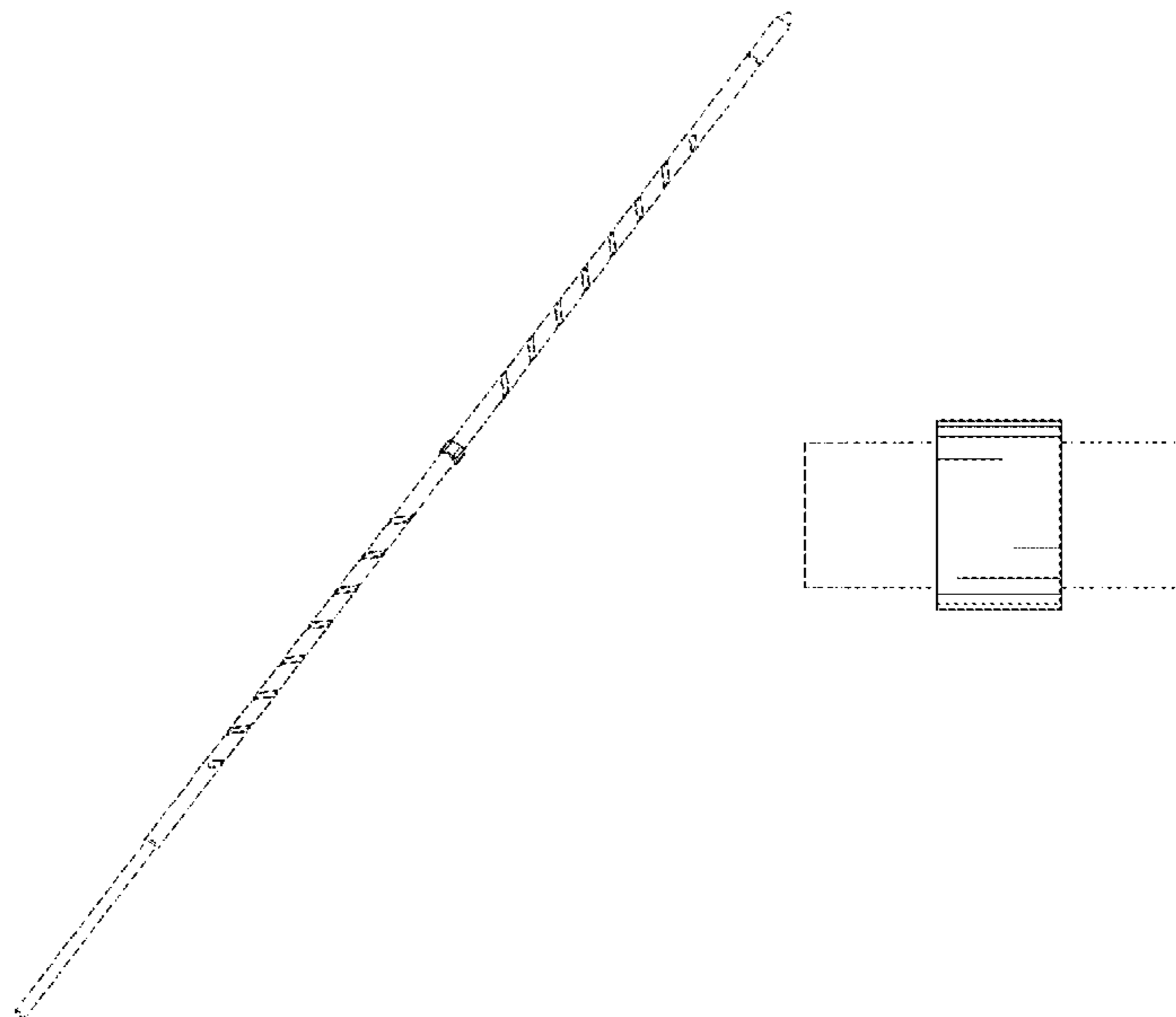

(56)

References Cited

U.S. PATENT DOCUMENTS

8,283,939 B2 * 10/2012 Li G01R 1/06766
 324/437
 D686,098 S * 7/2013 Agar G01R 1/067
 D10/78
 9,046,568 B2 * 6/2015 Ho G01R 1/06722
 D769,748 S * 10/2016 Teranishi G01R 1/06738
 D10/78
 D769,749 S * 10/2016 Teranishi G01R 1/06722
 D10/78
 D776,551 S * 1/2017 Teranishi G01R 1/06766
 D10/78
 D776,552 S * 1/2017 Teranishi G01N 27/83
 D10/78
 9,547,023 B2 * 1/2017 Lee G01R 1/06738
 9,810,715 B2 * 11/2017 Campbell G01R 1/06772
 10,241,133 B2 * 3/2019 Campbell G01R 1/06766
 2011/0050261 A1 * 3/2011 Li G01R 1/06766
 324/754.03
 2013/0069669 A1 * 3/2013 Mogaveera G01R 1/06777
 324/555
 2015/0070040 A1 * 3/2015 Treibergs G01R 1/06722
 324/754.11
 2015/0369859 A1 * 12/2015 Suzuki G01R 1/06722
 324/755.08
 2017/0138985 A1 * 5/2017 Teranishi G01R 1/067

FOREIGN PATENT DOCUMENTS

KR 300851780000 12/2016
 KR 3008851780000 12/2016
 TW D150990 12/2012

* cited by examiner

FIG. 1

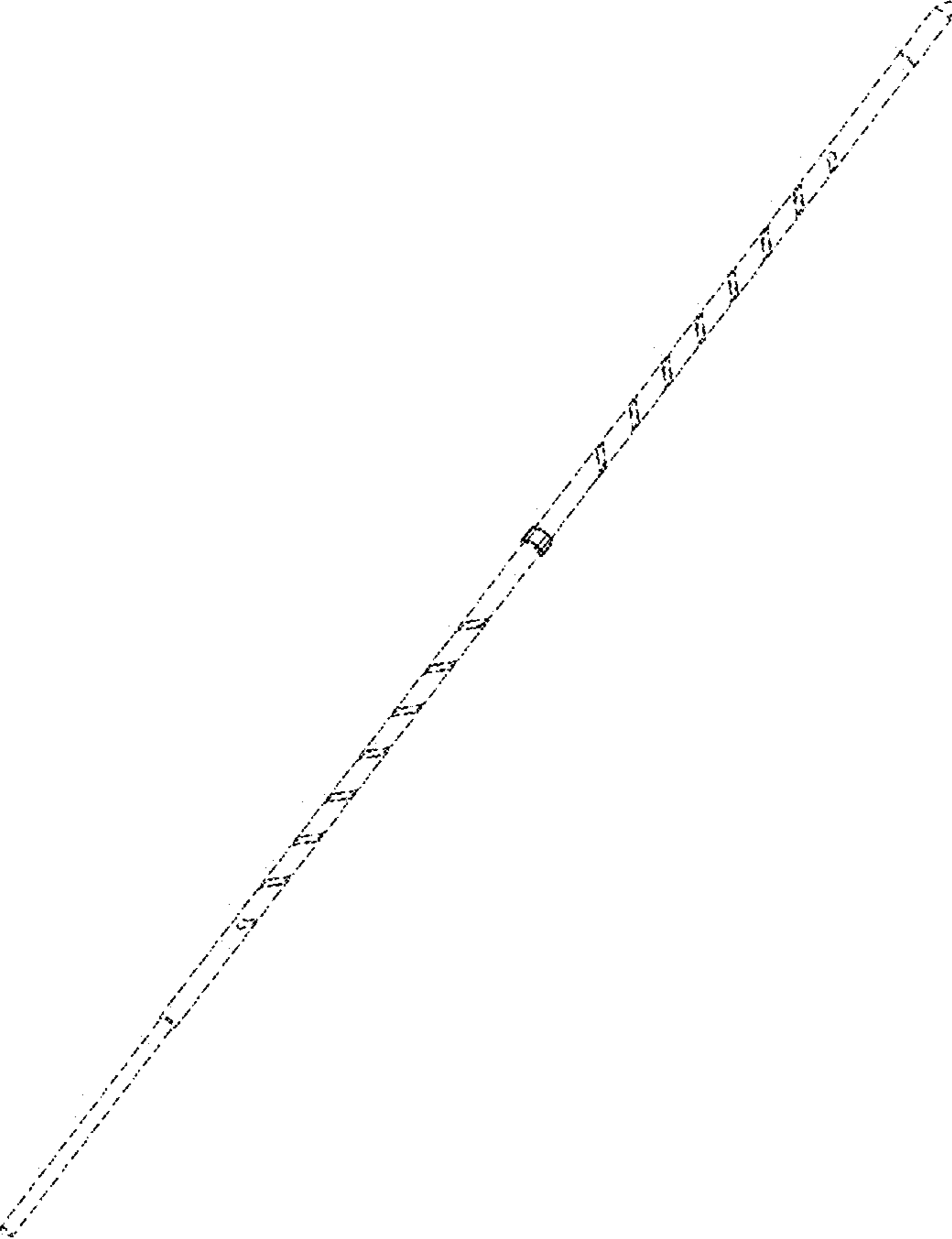

FIG.2

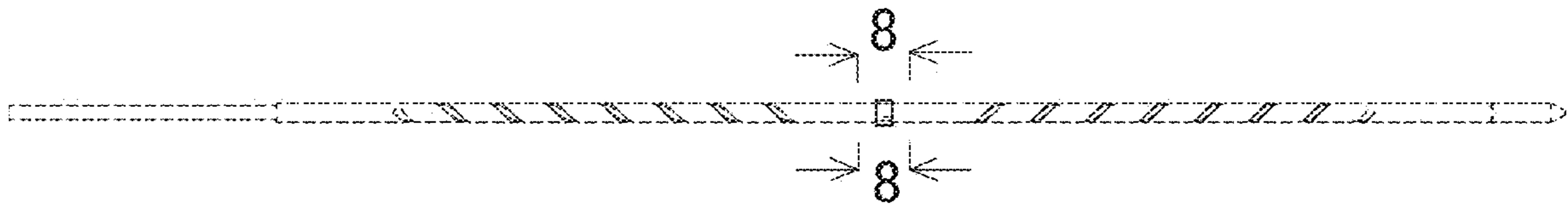

FIG.3

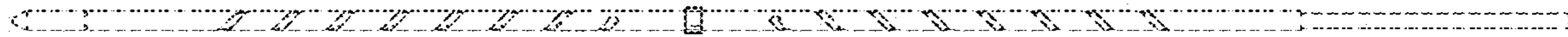

FIG.4



FIG.5



FIG.6

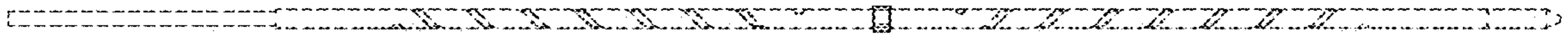

FIG.7

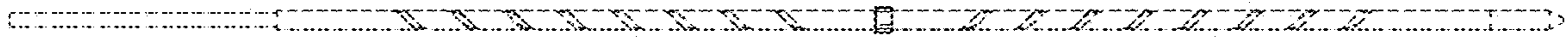

FIG.8

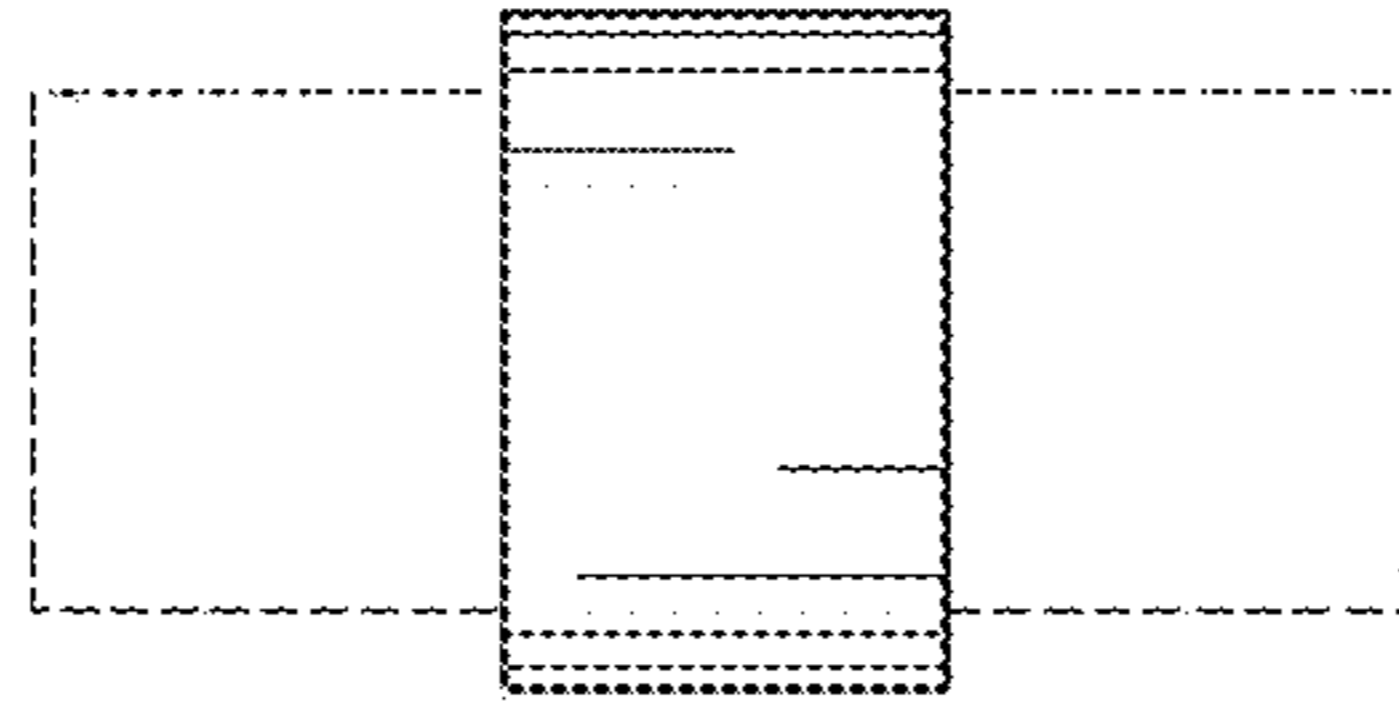

FIG.9

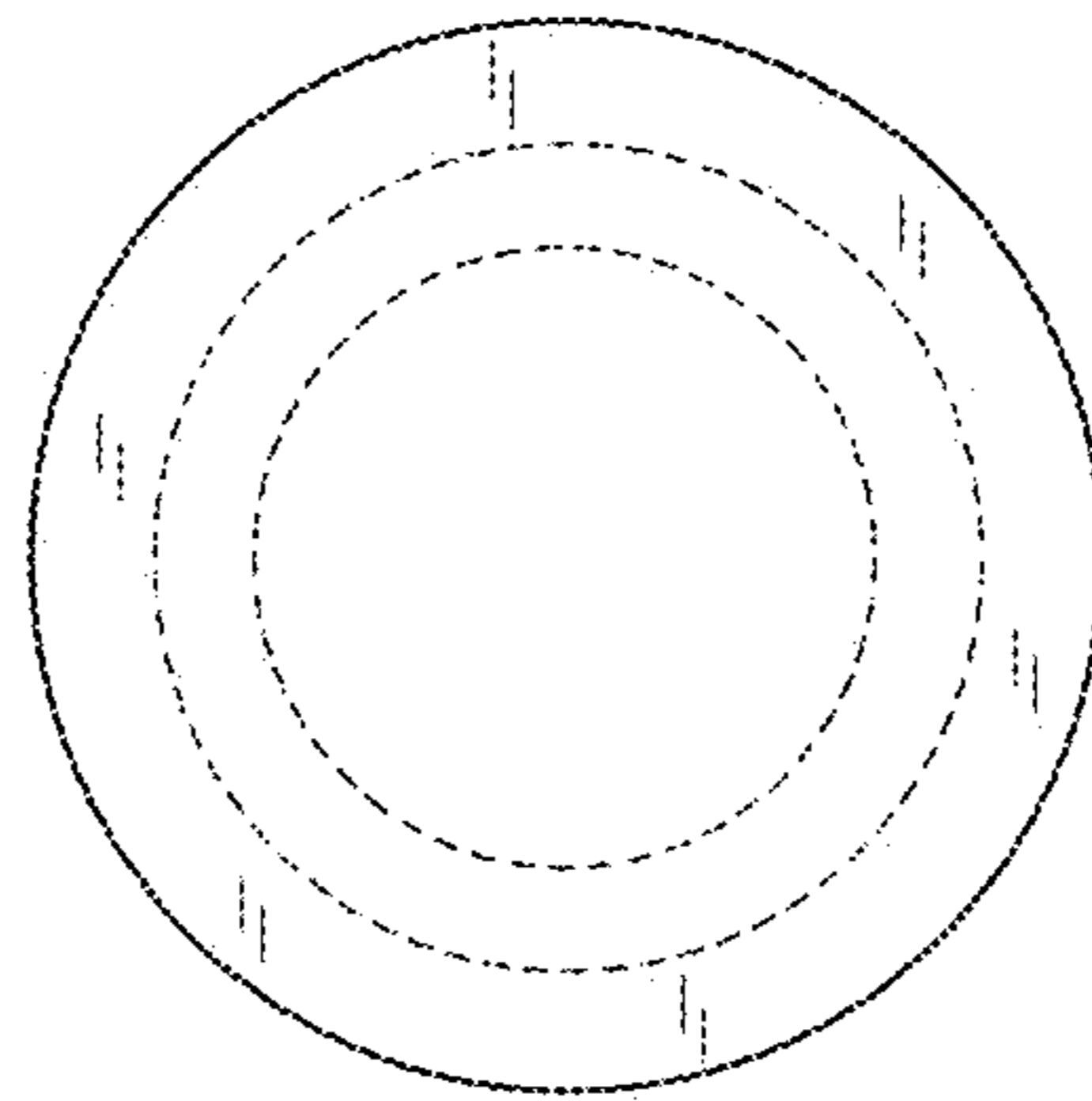

FIG.10

