



US00D873114S

(12) **United States Design Patent** (10) **Patent No.:** **US D873,114 S**
Hsu (45) **Date of Patent:** **** Jan. 21, 2020**

(54) **LOCK**

(56) **References Cited**

(71) Applicant: **Spectrum Brands, Inc.**, Middleton, WI (US)

U.S. PATENT DOCUMENTS

(72) Inventor: **Wei Hsu**, Lake Forest, CA (US)

D645,726	S	*	9/2011	Lu	D8/330
D732,372	S	*	6/2015	Gao	D8/334
D802,397	S	*	11/2017	Schneider	D8/331
10,122,138	B2	*	11/2018	Uyeda	E05B 47/00
2014/0250956	A1	*	9/2014	Chong	G07C 9/00174
						70/278.1
2018/0128017	A1	*	5/2018	Frolov	E05B 47/0692

(73) Assignee: **Spectrum Brands, Inc.**, Middleton, WI (US)

(**) Term: **15 Years**

* cited by examiner

(21) Appl. No.: **29/641,237**

Primary Examiner — Ian Simmons

(22) Filed: **Mar. 20, 2018**

Assistant Examiner — Yolanda Robinson

(51) **LOC (12) Cl.** **08-07**

(74) *Attorney, Agent, or Firm* — Banner & Witcoff, Ltd.

(52) **U.S. Cl.**

(57) **CLAIM**

USPC **D8/334**

The ornamental design for a lock, as shown and described.

(58) **Field of Classification Search**

DESCRIPTION

USPC D8/330, 333, 334, 335, 336, 337, 338,
D8/341, 342, 348, 350, 352, 339;
70/20–22, 57, 57.1, DIG. 26, DIG. 27,
70/DIG. 44, 91, 92, 102, 141, 237, 262,
70/263, 266, 278.1, 279.1
CPC ... E05B 9/00; E05B 9/02; E05B 47/00; E05B
49/00; E05B 37/00; E05B 1/00; E05B
47/0692; E05B 63/044; E05B 15/02;
H01H 9/00

FIG. 1 is a front perspective view of a lock showing my new design;
FIG. 2 is a front view thereof;
FIG. 3 is a right side view thereof;
FIG. 4 is a left side view thereof;
FIG. 5 is a top view thereof; and,
FIG. 6 is a bottom view thereof.
The broken lines showing the locking cylinder form no part of the claimed design.

See application file for complete search history.

1 Claim, 5 Drawing Sheets

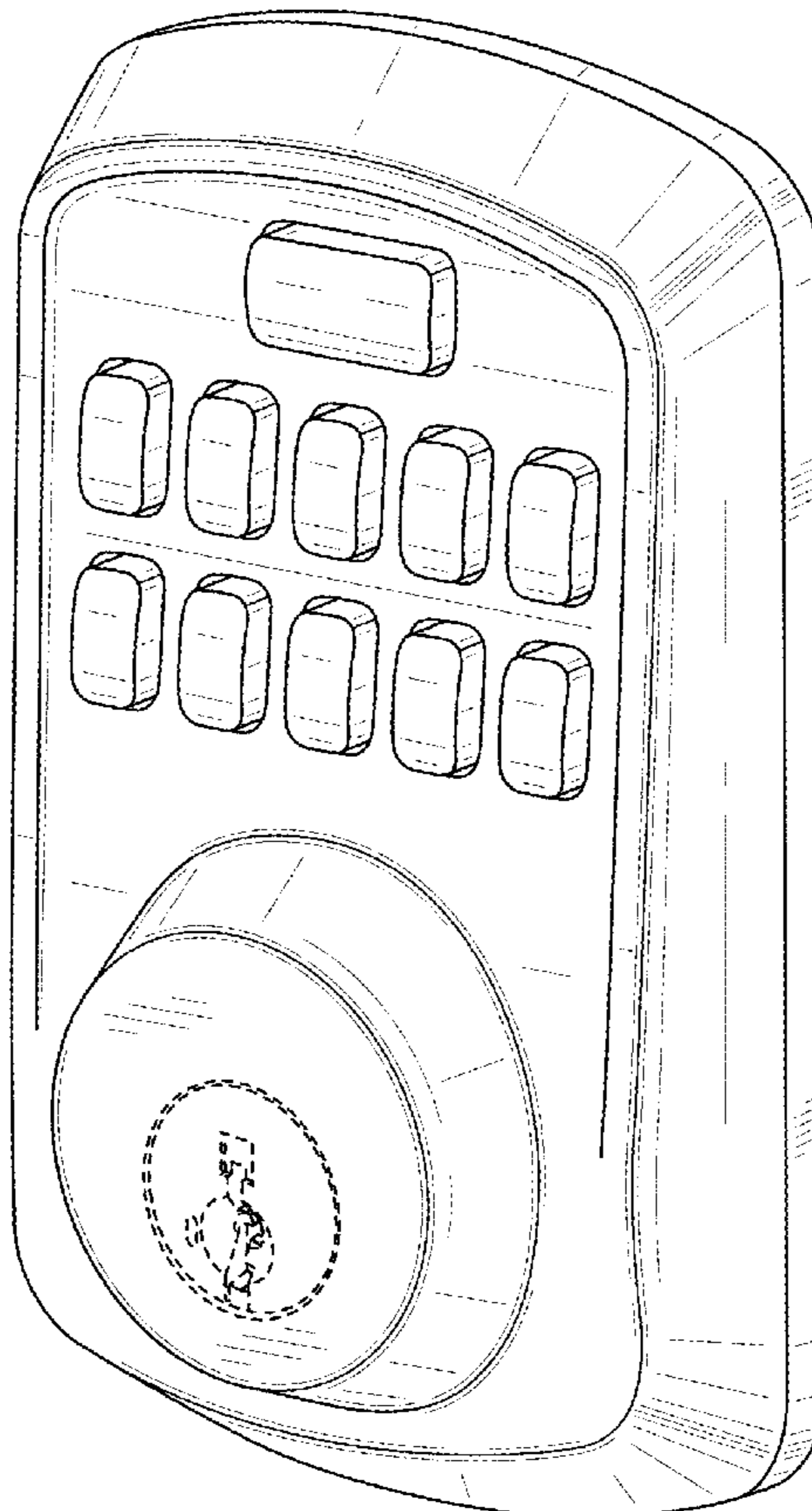

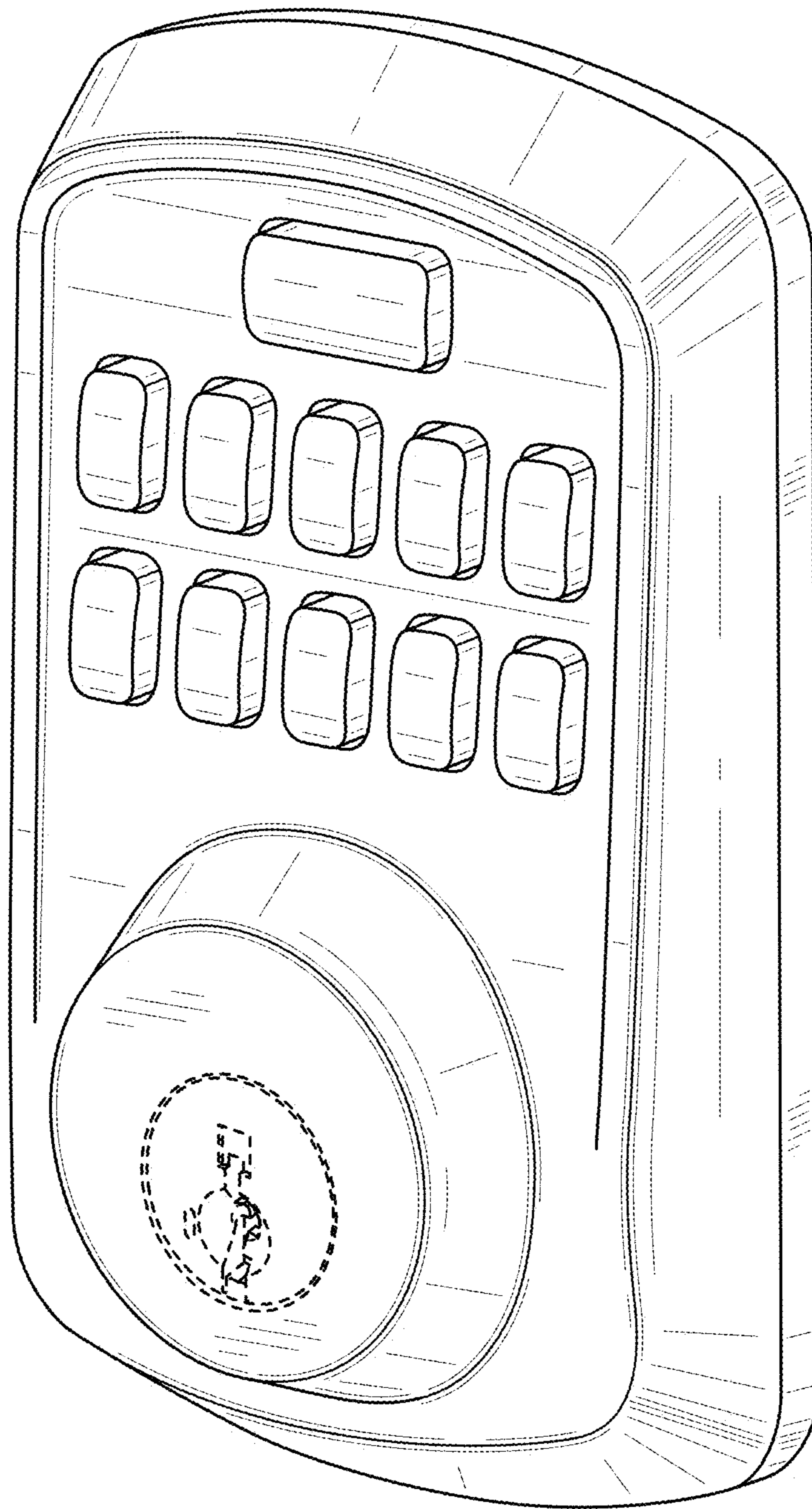

FIG. 1

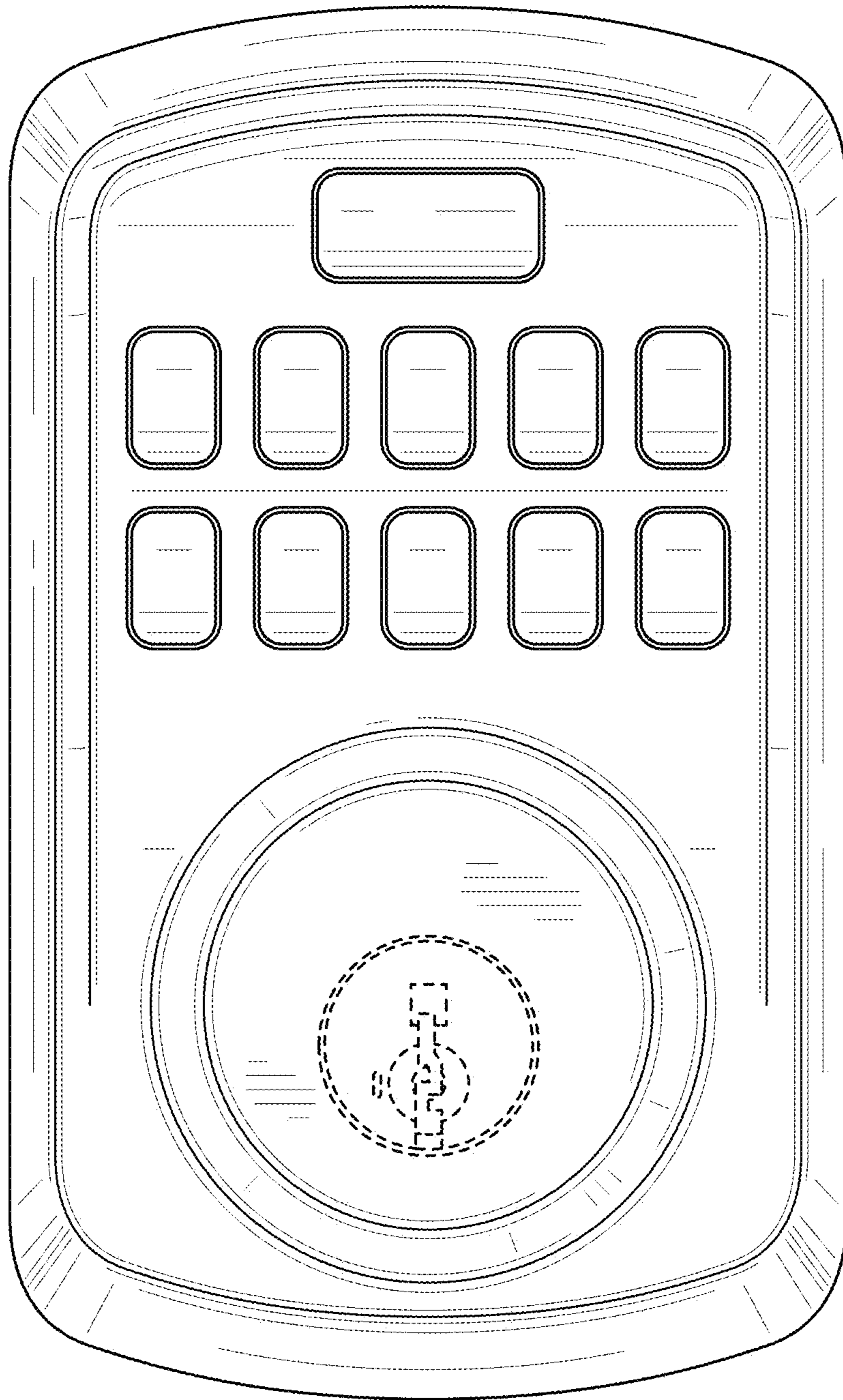

FIG. 2

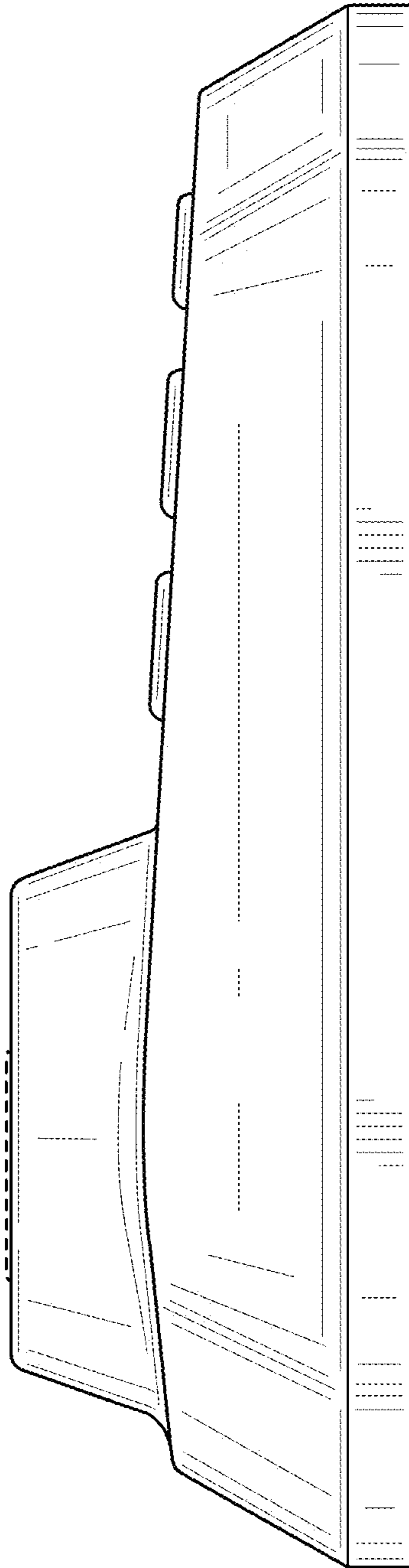

FIG. 3

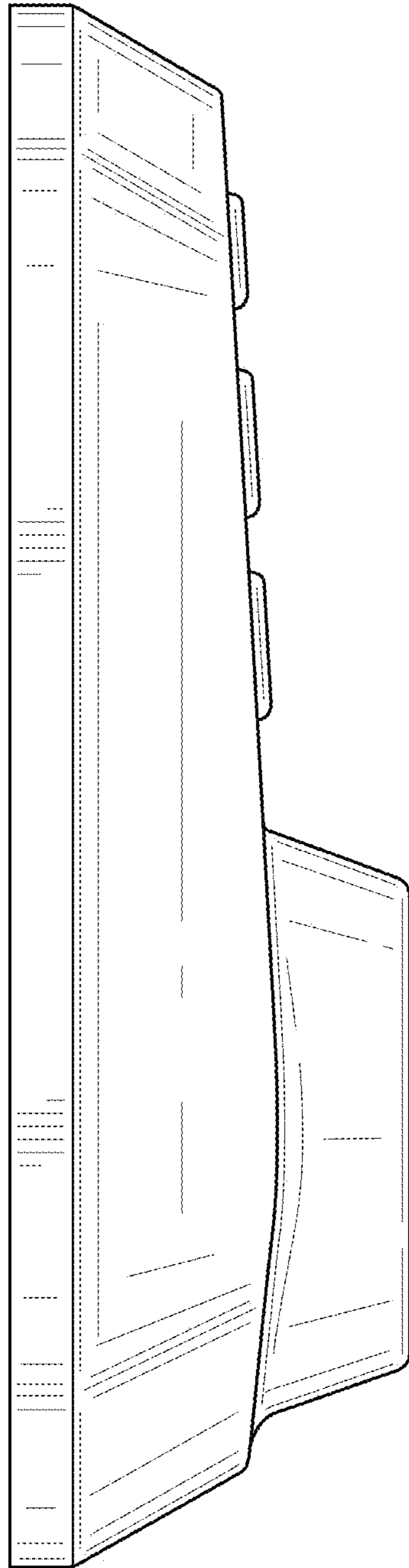

FIG. 4

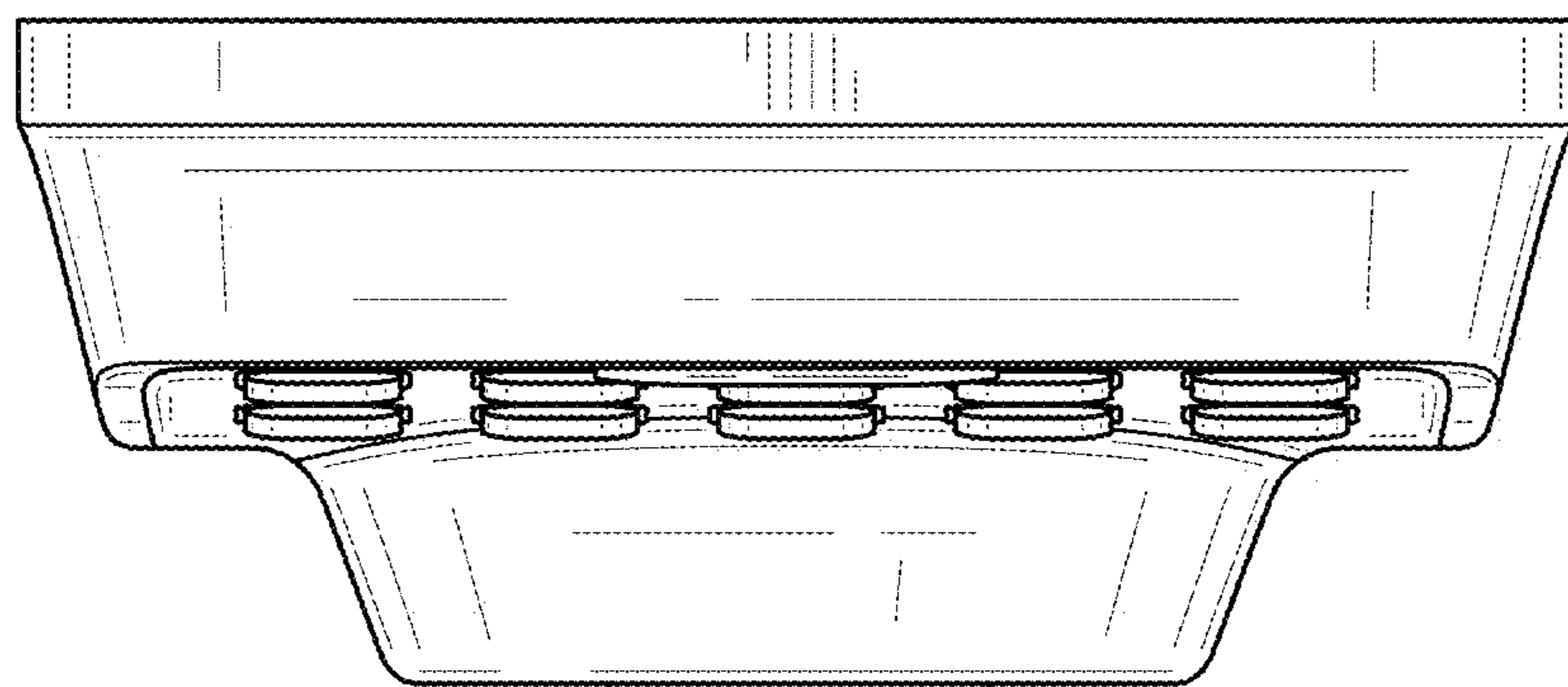

FIG. 5

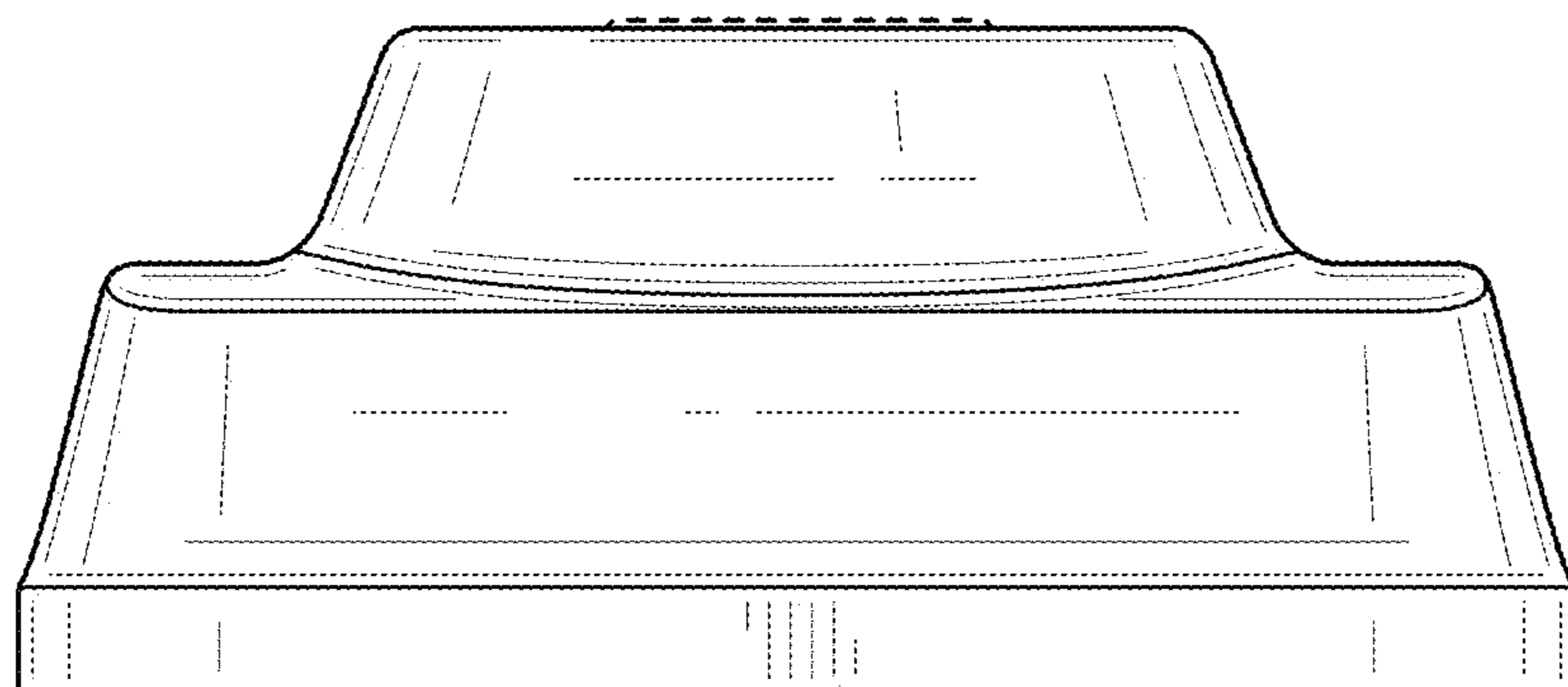

FIG. 6