



US00D873057S

(12) **United States Design Patent**
Tuang

(10) **Patent No.:** **US D873,057 S**
(45) **Date of Patent:** **** Jan. 21, 2020**

- (54) **PAN RACK**
- (71) Applicant: **EP Family Corp.**, Walnut, CA (US)
- (72) Inventor: **Bao-Yi Tuang**, Walnut, CA (US)
- (**) Term: **15 Years**
- (21) Appl. No.: **29/661,684**
- (22) Filed: **Aug. 29, 2018**
- (51) **LOC (12) Cl.** **06-06**
- (52) **U.S. Cl.**
USPC **D6/678.4**
- (58) **Field of Classification Search**
USPC D6/672, 673, 675, 678, 678.1, 678.4,
D6/680.2, 680.3, 681.1, 681.2, 682,
D6/682.3, 682.4
CPC A47B 55/02; A47B 61/04; A47G 19/08;
A47G 25/005; A47G 29/08; A47F 7/08
See application file for complete search history.

- D836,400 S * 12/2018 Goodman D7/601
- D843,792 S * 3/2019 Hsu D7/637
- D846,319 S * 4/2019 Min D6/675.2
- D850,169 S * 6/2019 Tsai D6/678.4
- D852,536 S * 7/2019 Arnall D6/522
- D857,094 S * 8/2019 Tsai D19/90
- D861,427 S * 10/2019 Irwin, Jr. D7/409

* cited by examiner

Primary Examiner — Kelley A Donnelly
(74) *Attorney, Agent, or Firm* — Tommy SF Wang; Wang IP Law Group, P.C.

(57) **CLAIM**

The ornamental design for a pan rack, as shown and described.

DESCRIPTION

FIG. 1 is a perspective view of a pan rack showing my new design;
 FIG. 2 is a front view thereof;
 FIG. 3 is a rear view thereof;
 FIG. 4 is a left side view thereof;
 FIG. 5 is a right side view thereof;
 FIG. 6 is a top view thereof;
 FIG. 7 is a bottom view thereof;
 FIG. 8 is an enlarged view of an indicated portion of FIG. 1; and,
 FIG. 9 is another perspective view thereof with additional frames.
 The broken line portions of the pan rack in FIGS. 1-9 represent unclaimed portions of the claimed design and form no part thereof. The broken lines of the additional frames in FIG. 9 illustrate unclaimed environment and form no part of the claimed design. The dot-dash broken lines in FIGS. 1-5 and 8-9 represent unclaimed boundary lines and form no part of the claimed design.

(56) **References Cited**
U.S. PATENT DOCUMENTS

- D330,471 S * 10/1992 Rogers D15/199
- D555,203 S * 11/2007 Goodman D19/90
- D567,540 S * 4/2008 Klein D6/678.4
- D572,939 S * 7/2008 Murray D6/678.4
- D588,378 S * 3/2009 Goodman D7/704
- D723,344 S * 3/2015 Goodman D7/704
- D729,021 S * 5/2015 Goodman D7/704
- D736,566 S * 8/2015 Tsai D7/601
- D774,356 S * 12/2016 Maiorana D7/409
- D778,642 S * 2/2017 Tsai D6/678.4
- D798,637 S * 10/2017 Min D6/678.4
- D823,078 S * 7/2018 Tuang D7/704
- D826,659 S * 8/2018 Klein D7/704
- D826,660 S * 8/2018 Klein D7/704
- D835,439 S * 12/2018 Tsai D6/678.4

1 Claim, 9 Drawing Sheets

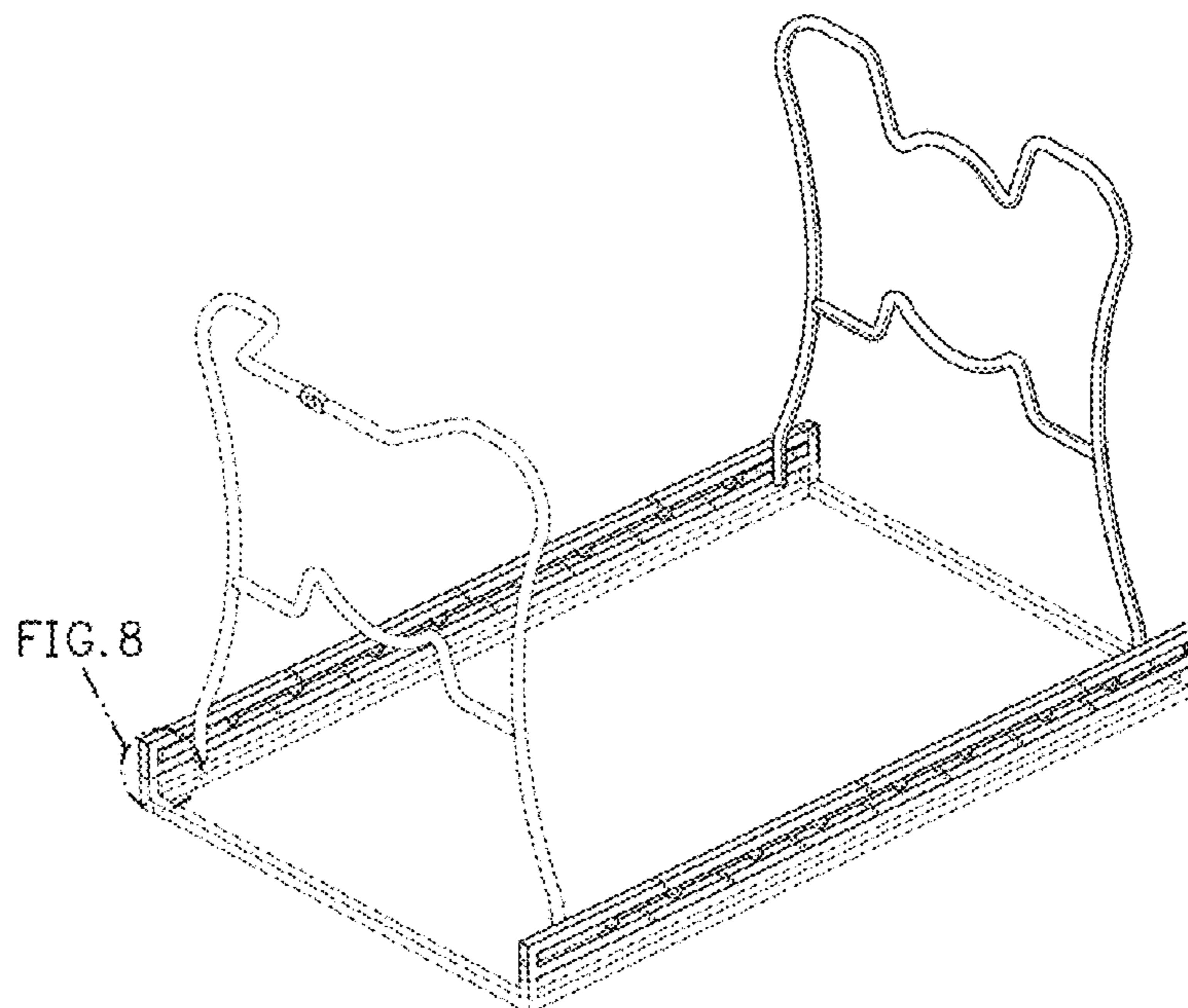

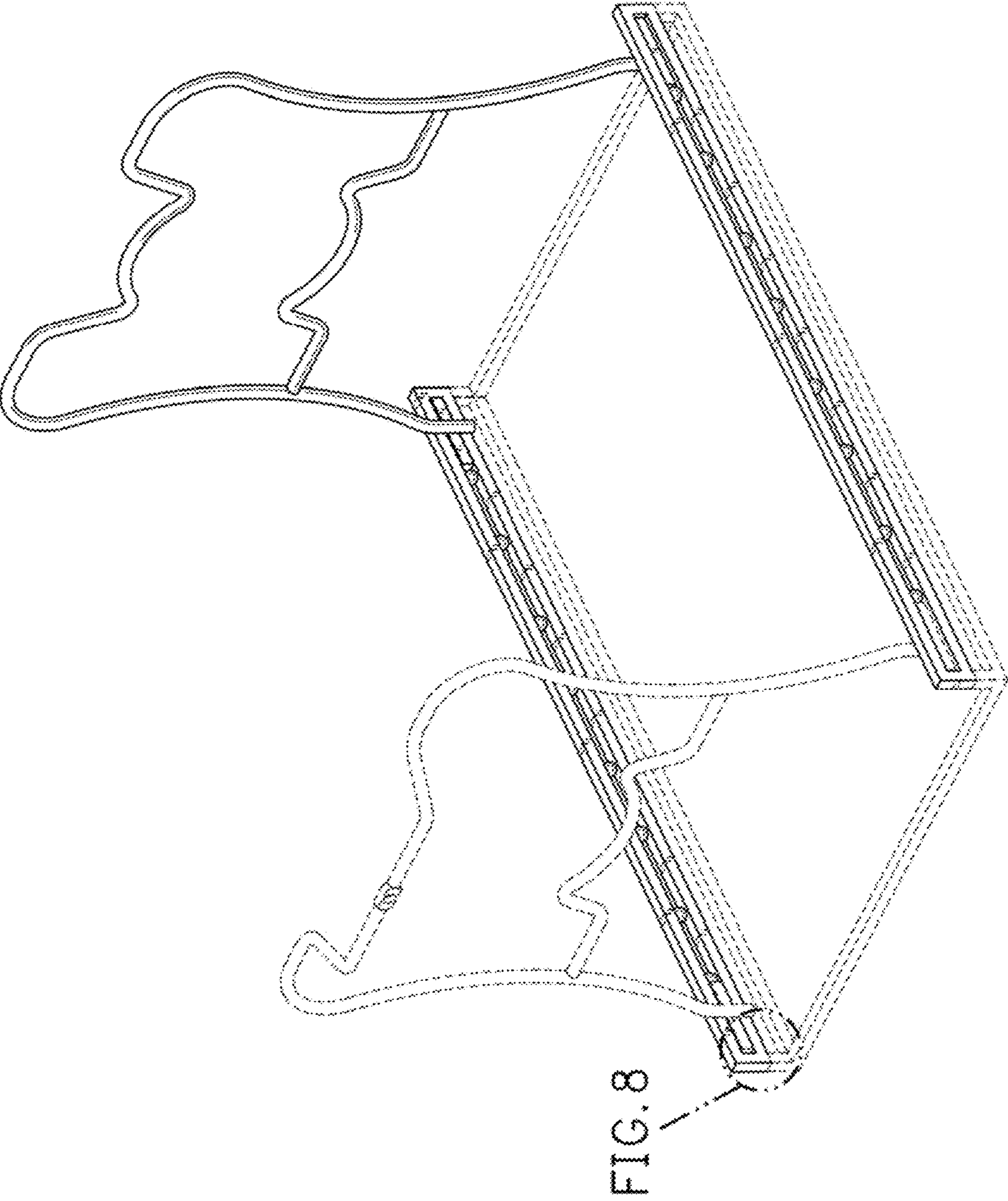

FIG. 1

FIG. 8

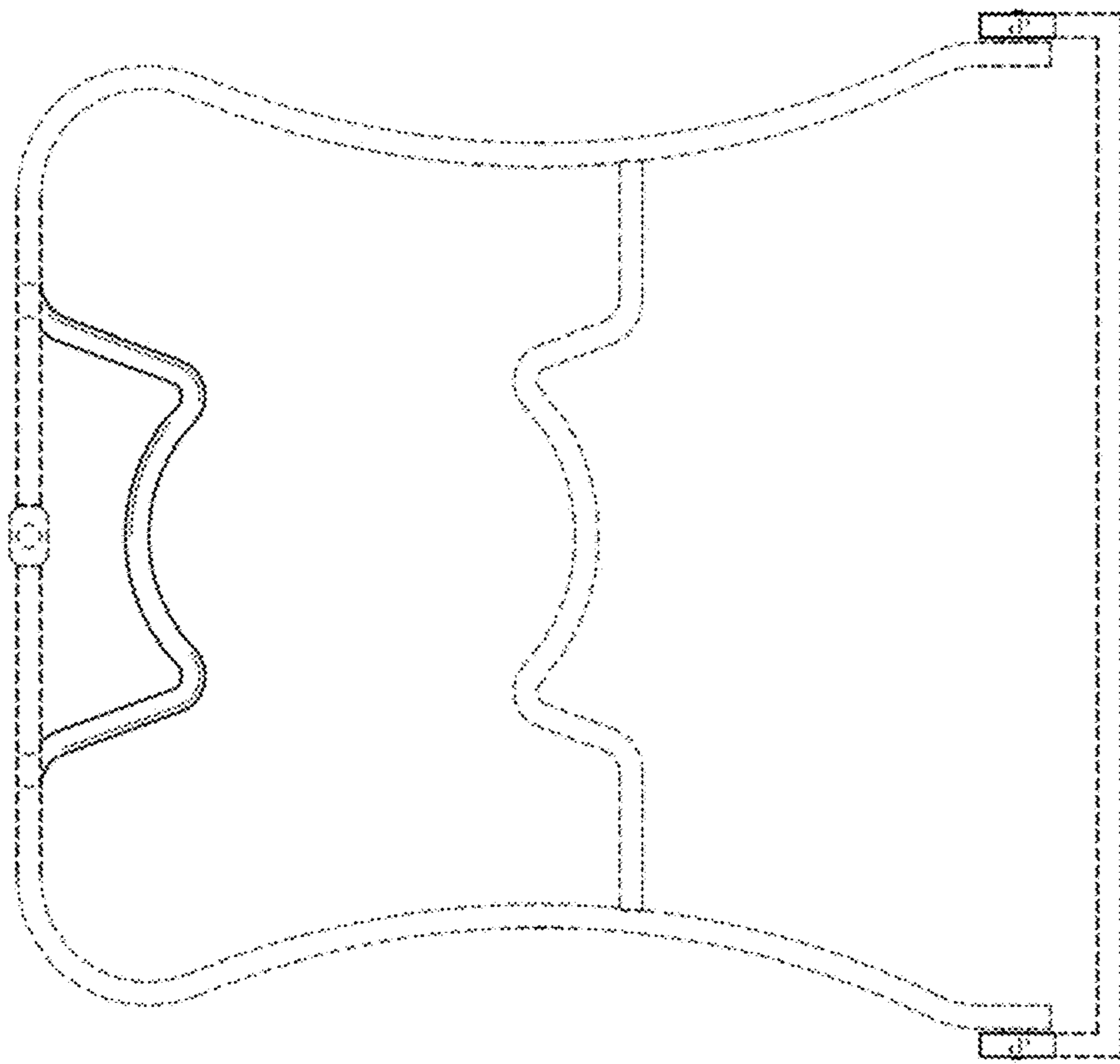

FIG. 2

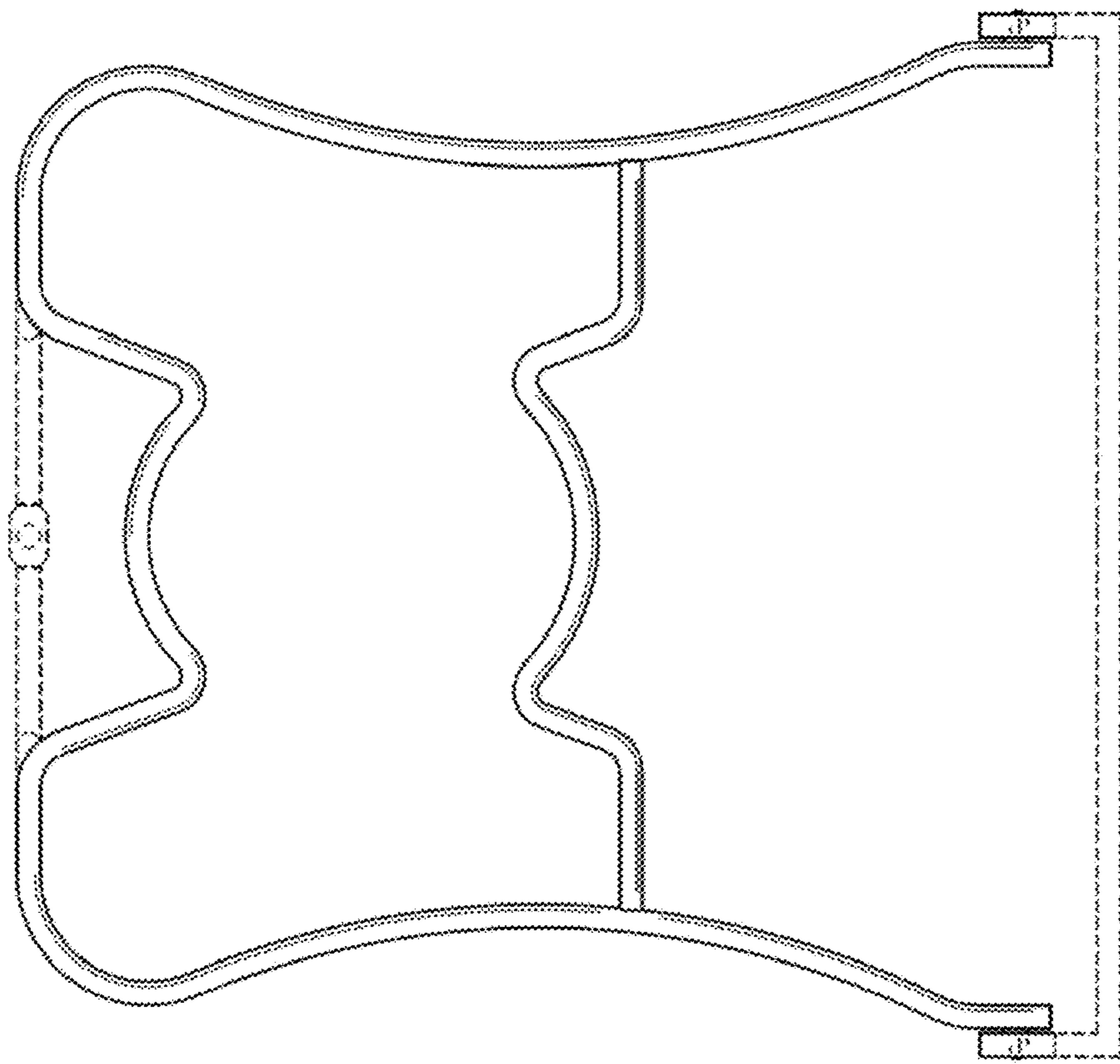

FIG. 3

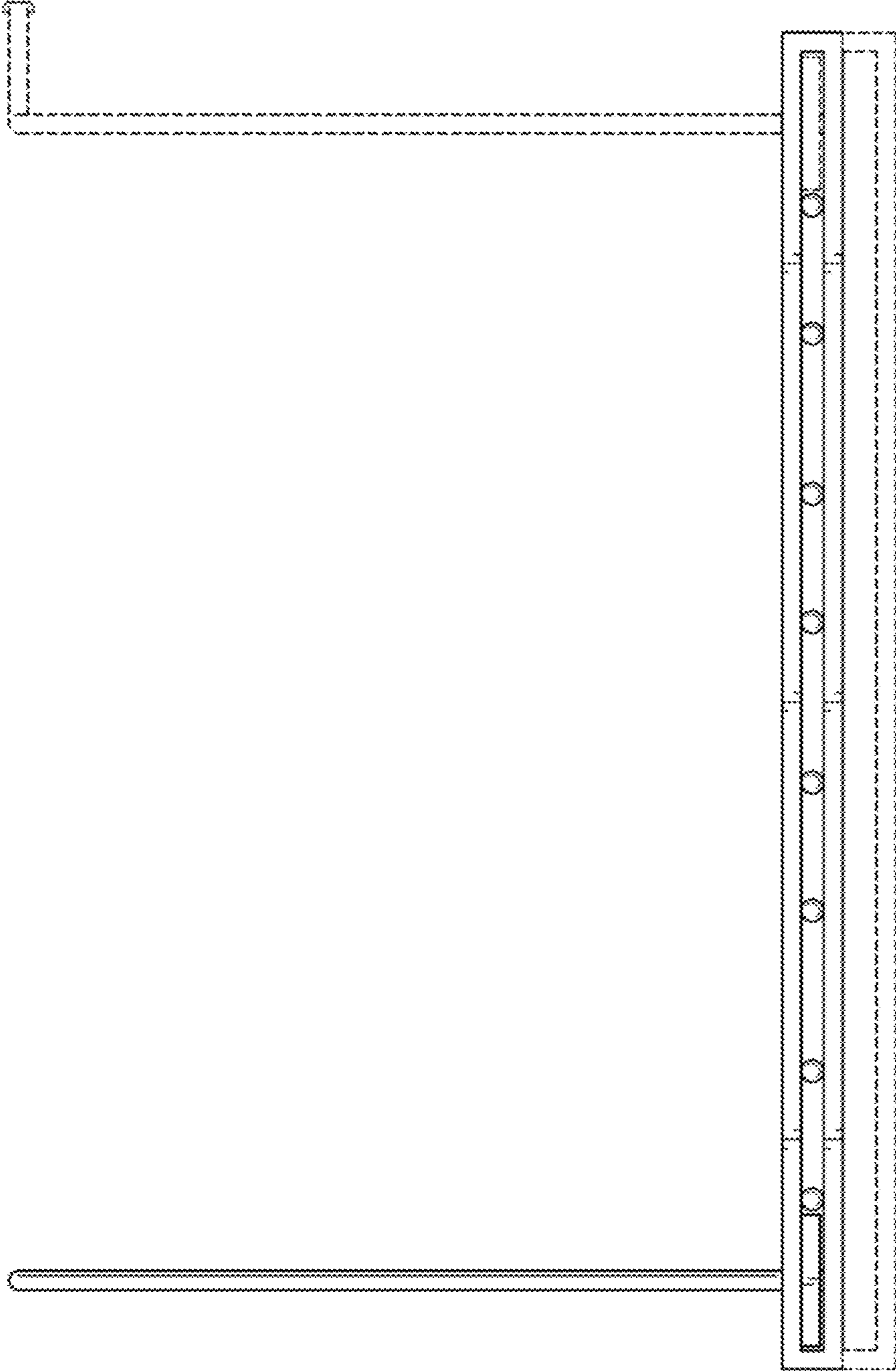

FIG. 4

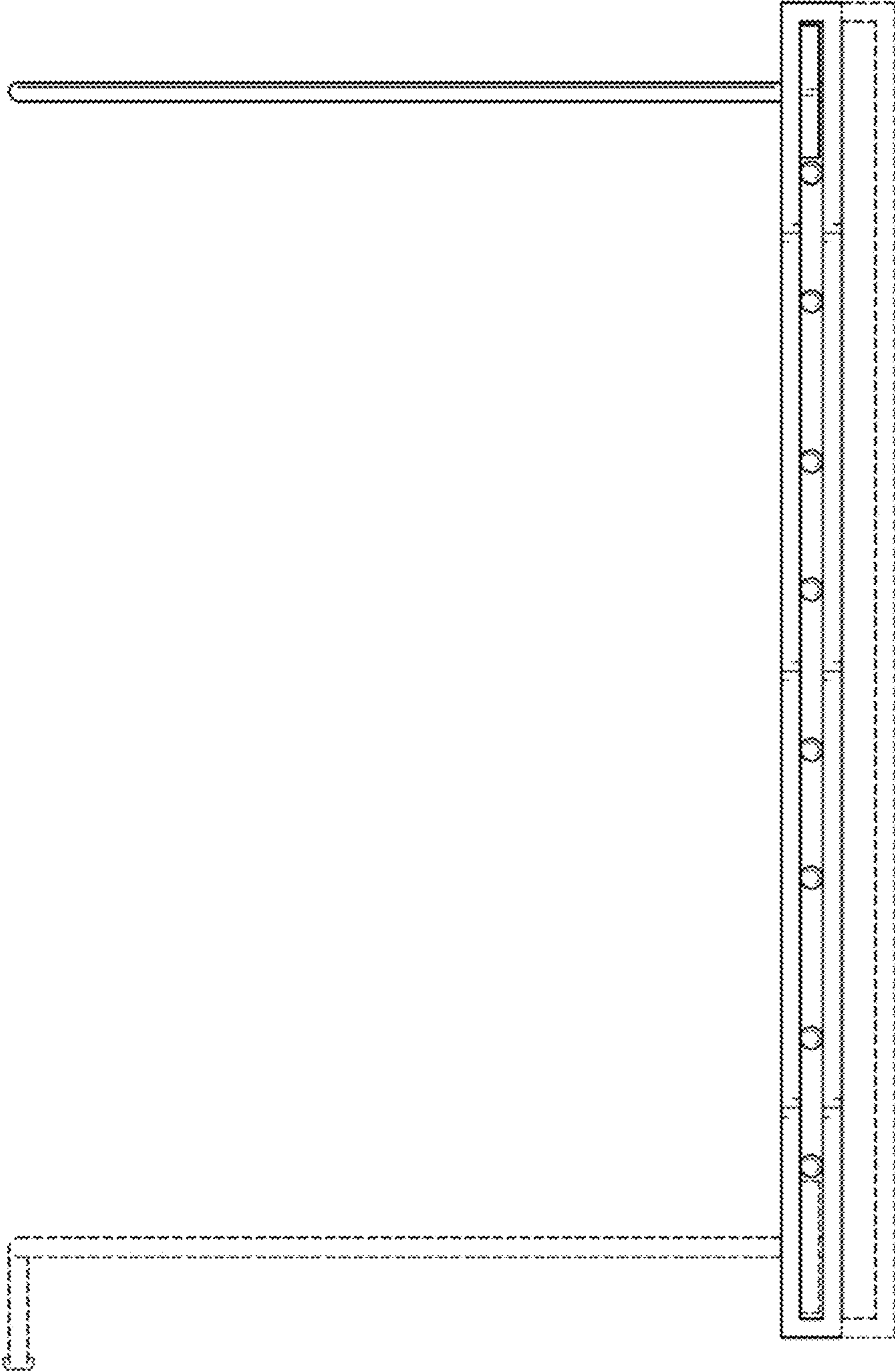

FIG. 5

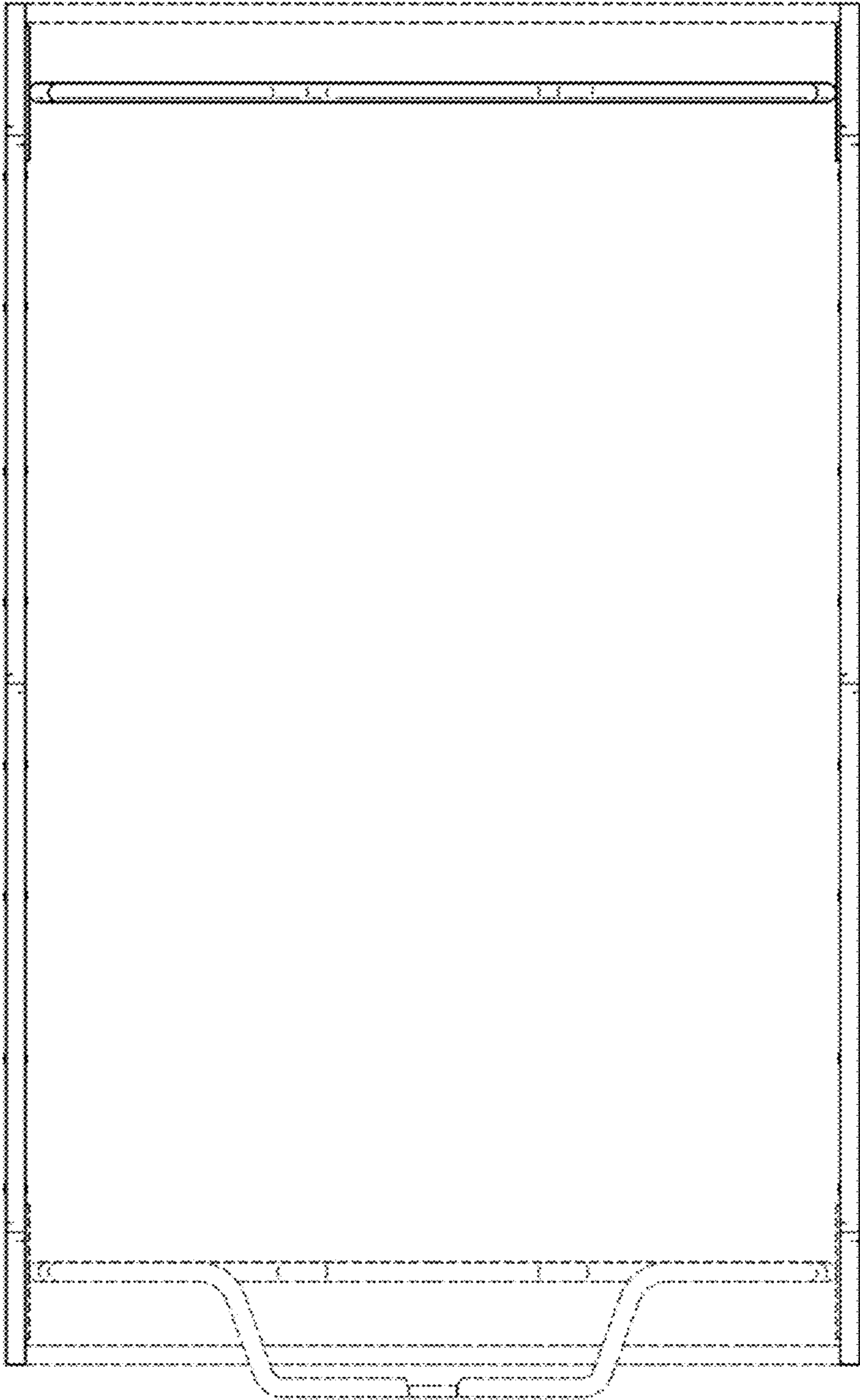

FIG. 6

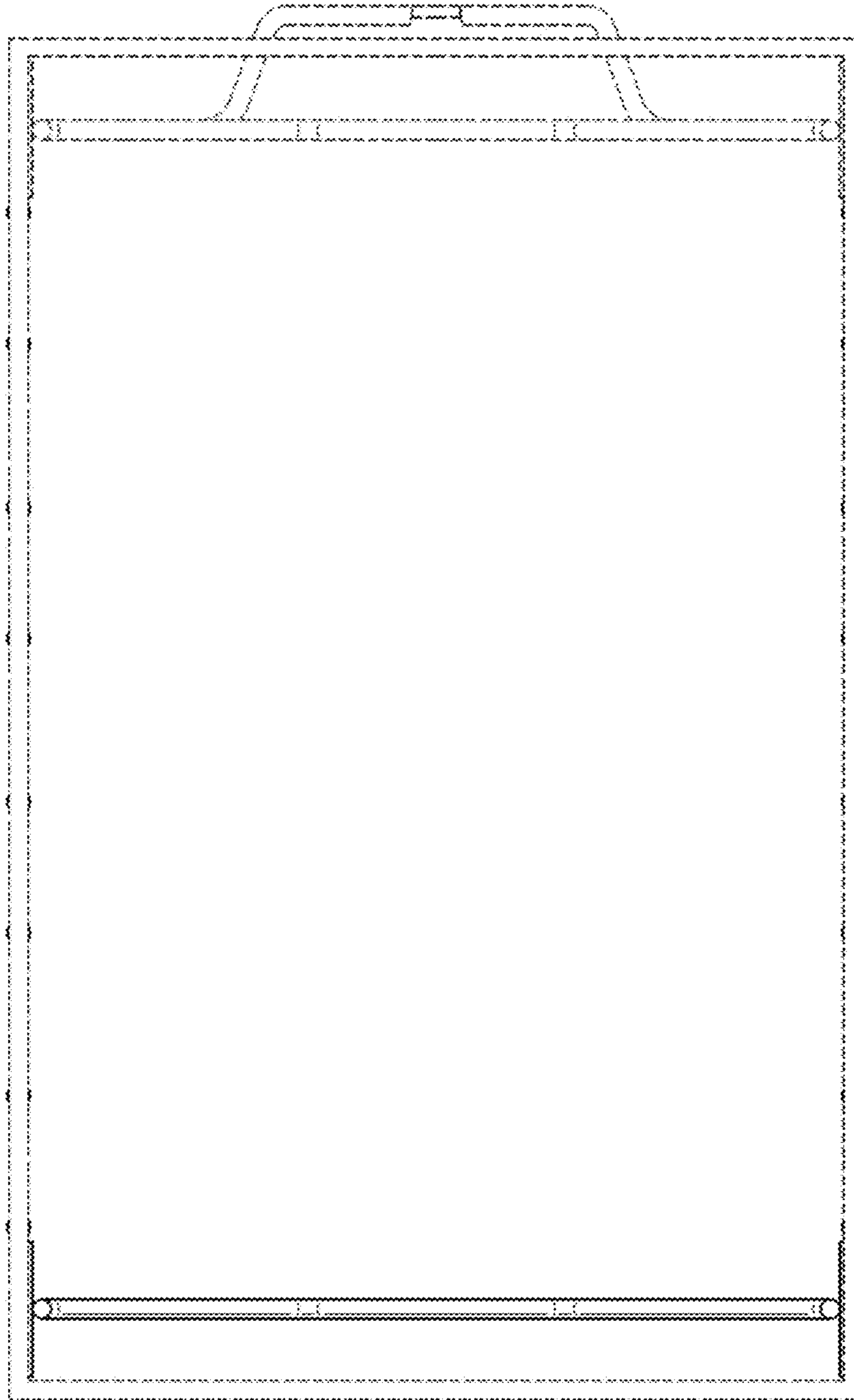

FIG. 7

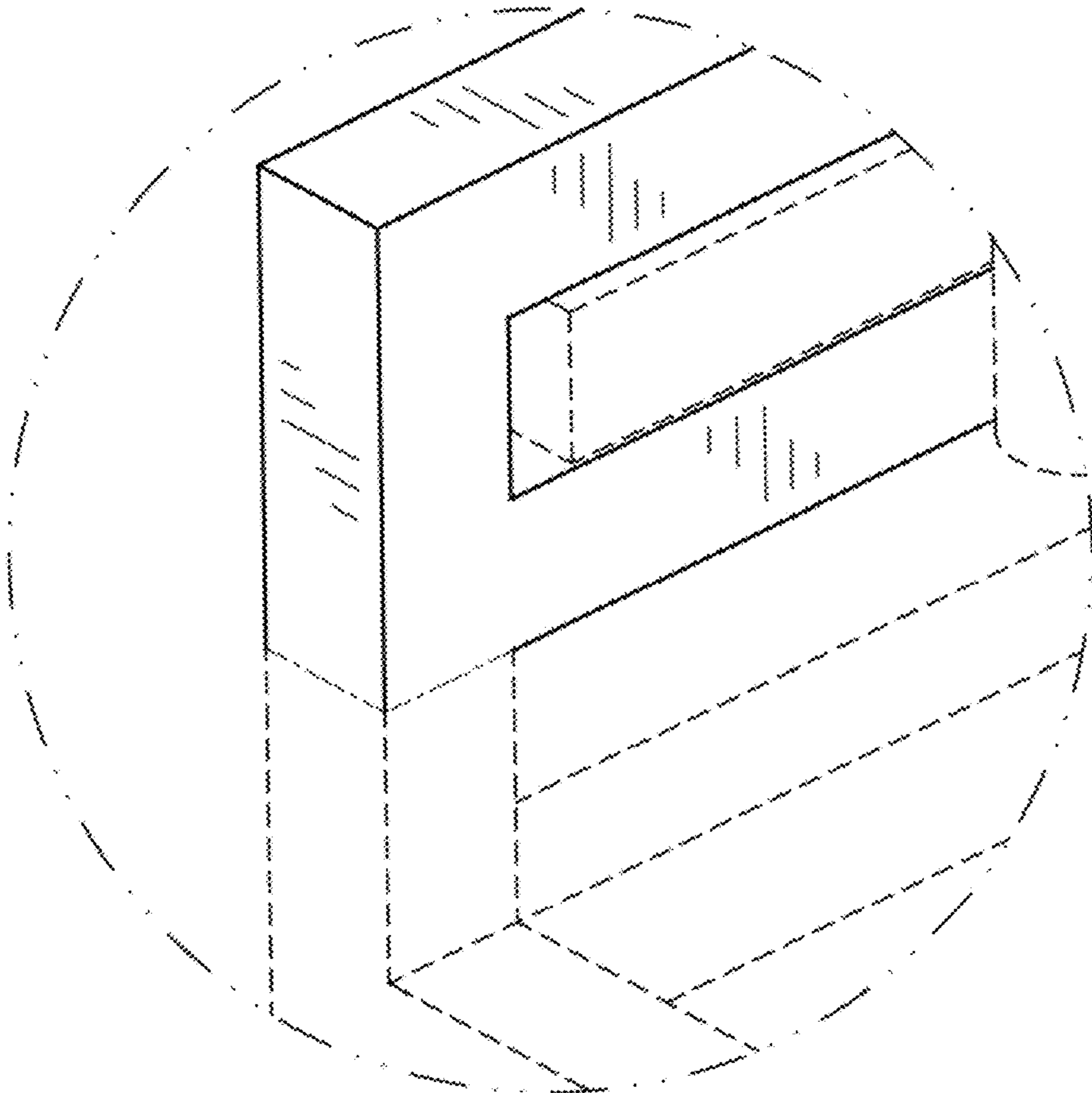

FIG. 8

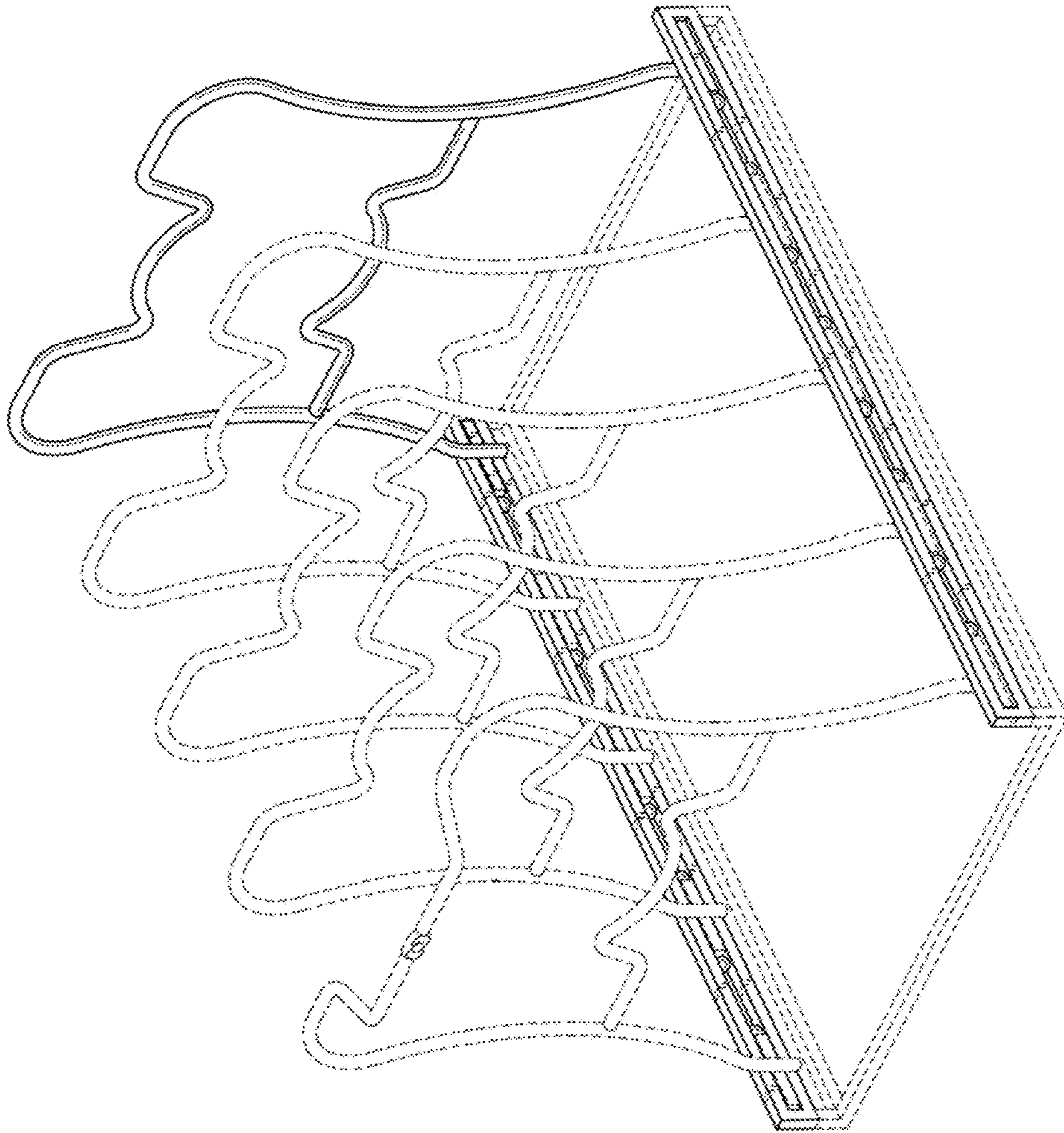

FIG. 9