



US00D873023S

(12) **United States Design Patent** (10) **Patent No.:** **US D873,023 S**
Mather (45) **Date of Patent:** **** Jan. 21, 2020**

- (54) **BACKPACK**
- (71) Applicant: **Thule, Inc.**, Seymour, CT (US)
- (72) Inventor: **Ryan Mather**, Boulder, CO (US)
- (73) Assignee: **Thule, Inc.**, Seymour, CT (US)
- (**) Term: **15 Years**
- (21) Appl. No.: **29/679,382**
- (22) Filed: **Feb. 5, 2019**

D713,139 S * 9/2014 Ford D3/217
 D734,948 S 7/2015 Farrelly
 D739,653 S * 9/2015 Majeau D3/217
 D744,721 S 12/2015 Crye
 (Continued)

OTHER PUBLICATIONS

Live for the Outdoors, "Lowe Alpine Manaslu 55-65 (2016)",
 Posted Apr. 4, 2016. (<https://www.livefortheoutdoors.com/gear-reviews/rucksacks/articles/2016/4/4/lowe-alpine-manaslu-55/65/2016>) (Year: 2016).*

(Continued)

Related U.S. Application Data

- (63) Continuation of application No. 29/607,904, filed on Jun. 16, 2017, now Pat. No. Des. 840,157.
- (51) **LOC (12) Cl.** **03-01**
- (52) **U.S. Cl.**
USPC **D3/318**; D3/217
- (58) **Field of Classification Search**
USPC D3/201, 215, 216, 217, 218, 222, 273,
D3/276, 284, 285, 289, 290, 291, 900,
D3/318, 319, 321, 322
CPC A45C 3/02; A45C 2003/008; A45C 5/03;
A45C 2011/003; A45C 5/00; A45C
2005/032; A45C 5/08; A45C 5/14; A45F
3/04
See application file for complete search history.

Primary Examiner — April Rivas

(74) *Attorney, Agent, or Firm* — Sterne, Kessler, Goldstein & Fox P.L.L.C.

(57) **CLAIM**

The ornamental design for a backpack, as shown and described.

DESCRIPTION

FIG. 1 is a top front perspective view of a backpack showing the claimed design;
 FIG. 2 is a front view thereof;
 FIG. 3 is a rear view thereof;
 FIG. 4 is a right side view thereof;
 FIG. 5 is a left side view thereof;
 FIG. 6 is a top view thereof;
 FIG. 7 is a bottom view thereof; and,
 FIG. 8 is an enlarged front side perspective view of a portion of the backpack shown in FIGS. 1-7, with a portion of the backpack in an open configuration showing interior details of the design.
 The dashed broken lines in the figures show portions of the backpack that form no part of the claimed design.
 The dot-dash broken lines in the figures show boundaries that form no part of the claimed design.

1 Claim, 8 Drawing Sheets

(56) **References Cited**
U.S. PATENT DOCUMENTS

- D508,315 S 8/2005 Han
- D513,715 S 1/2006 Fayle et al.
- D550,449 S 9/2007 Gossett
- D601,344 S * 10/2009 Chu D3/321
- D665,573 S * 8/2012 Crandall D3/217
- D699,032 S * 2/2014 Bendavid D3/216
- D699,943 S * 2/2014 Mather D3/216
- D699,944 S * 2/2014 Mather D3/216
- D706,534 S 6/2014 Zwetzig
- D710,108 S 8/2014 Kinskey et al.

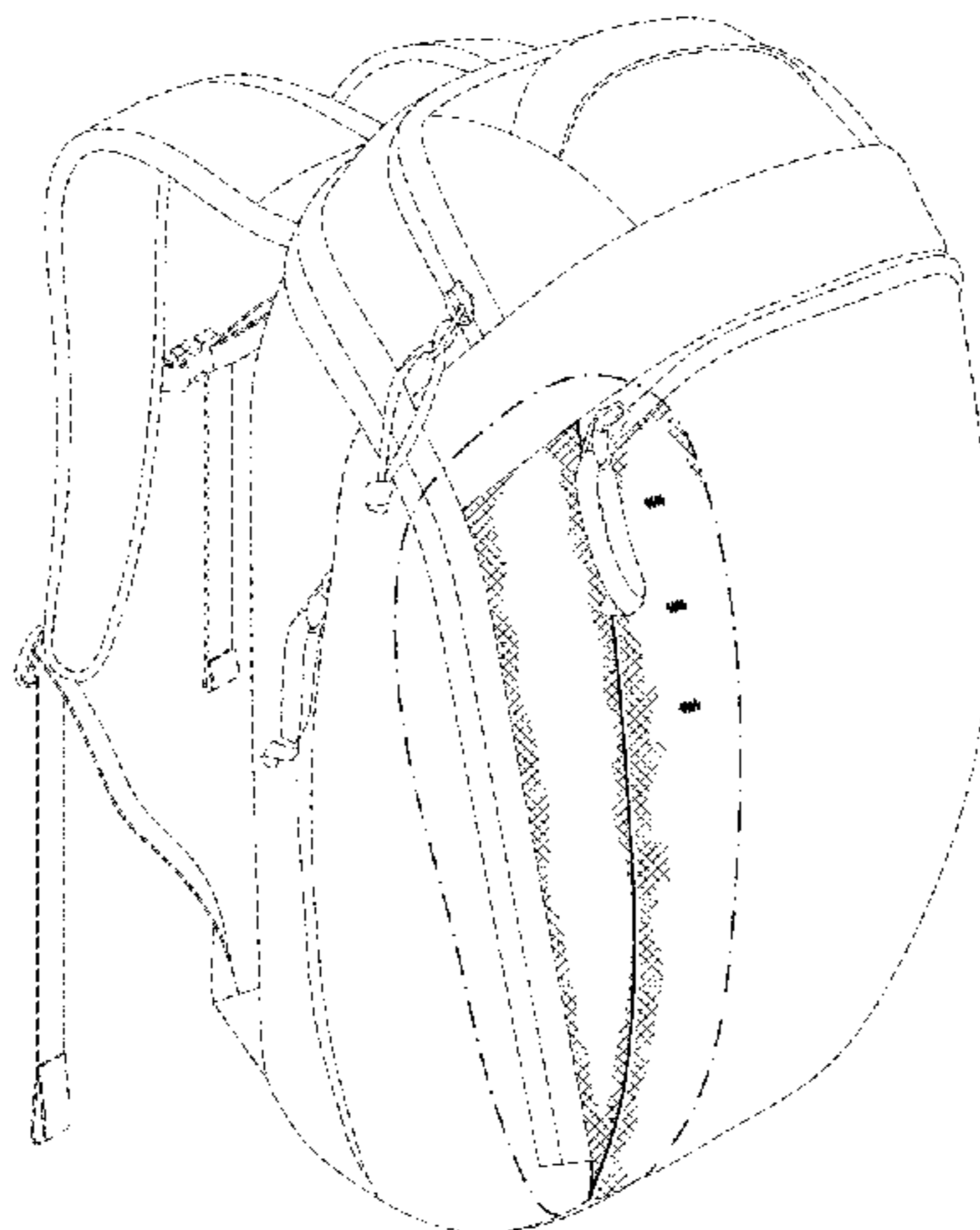

(56)

References Cited

U.S. PATENT DOCUMENTS

D758,715 S * 6/2016 Daniel D3/217
 D759,369 S * 6/2016 Mei Yee D3/216
 D770,761 S 11/2016 Deioma et al.
 D771,372 S * 11/2016 Kelly D3/217
 D781,573 S * 3/2017 Kelly D3/217
 D784,193 S 4/2017 Freddi et al.
 D784,659 S 4/2017 Darmour
 D802,295 S 11/2017 Wu
 D819,328 S * 6/2018 Muhlenkamp, IV D3/217
 D829,435 S * 10/2018 Viger D3/217
 D831,952 S * 10/2018 Pennington D3/217
 D836,326 S * 12/2018 Skaff D3/217
 D843,714 S * 3/2019 Sheikh D3/217
 D844,319 S * 4/2019 Tan D3/217
 D844,975 S * 4/2019 Munie D3/217
 2002/0139820 A1 10/2002 Godshaw et al.
 2007/0062996 A1* 3/2007 Miles A45C 13/103
 224/657
 2007/0235490 A1* 10/2007 Katz A45C 15/00
 224/579
 2010/0108731 A1 5/2010 Rowe et al.
 2015/0060221 A1* 3/2015 Bourette A45C 5/14
 190/18 A

2016/0278506 A1* 9/2016 Amago A45F 3/04
 2017/0007009 A1* 1/2017 Guthrie A45C 13/30
 2018/0116359 A1* 5/2018 Demke A45C 13/40

OTHER PUBLICATIONS

Behance, "Thule Paramount Daypack Collection", First published Jul. 31, 2014. (<https://www.behance.net/gallery/17608533/Thule-Paramount-Daypack-Collection>) (Year: 2014).*

Amazon, "Gregory Mountain Products Sketch 25 Liter Daypack . . .", First reviewed Jan. 25, 2015. (<https://www.amazon.com/Gregory-Dedicated-Compartment-Construction-Organization/dp/B07998PJQc>) (Year: 2015).*

Thule.com, "Thule EnRoute Triumph 2" <https://www.thule.com/en/se/backpacks/laptop-backpacks/thule-enroute-triumph-2_tl_tetd-215-black>, accessed Aug. 24, 2017.

Thule.com, "Thule EnRoute Backpack 13L" <https://www.thule.com/en/se/backpacks/laptop-backpacks/thule-enroute-backpack-13l_-3203431>, accessed Aug. 24, 2017.

Amazon, "Thule Accent Backpack 28L", First on sale Sep. 21, 2017. (<https://www.amazon.com/dp/B07588P2VLI>).

Amazon, "Thule 3203596 EnRoute Backpack 23L", First on sale Dec. 8, 2017. (<https://www.amazon.com//dp/B078TVX8Y4/>).

Eddie Bauer, "Sorcerer Pack", First reviewed Apr. 15, 2014. (<http://www.eddiebauer.com/product/sorcerer-pack/82302321>).

* cited by examiner

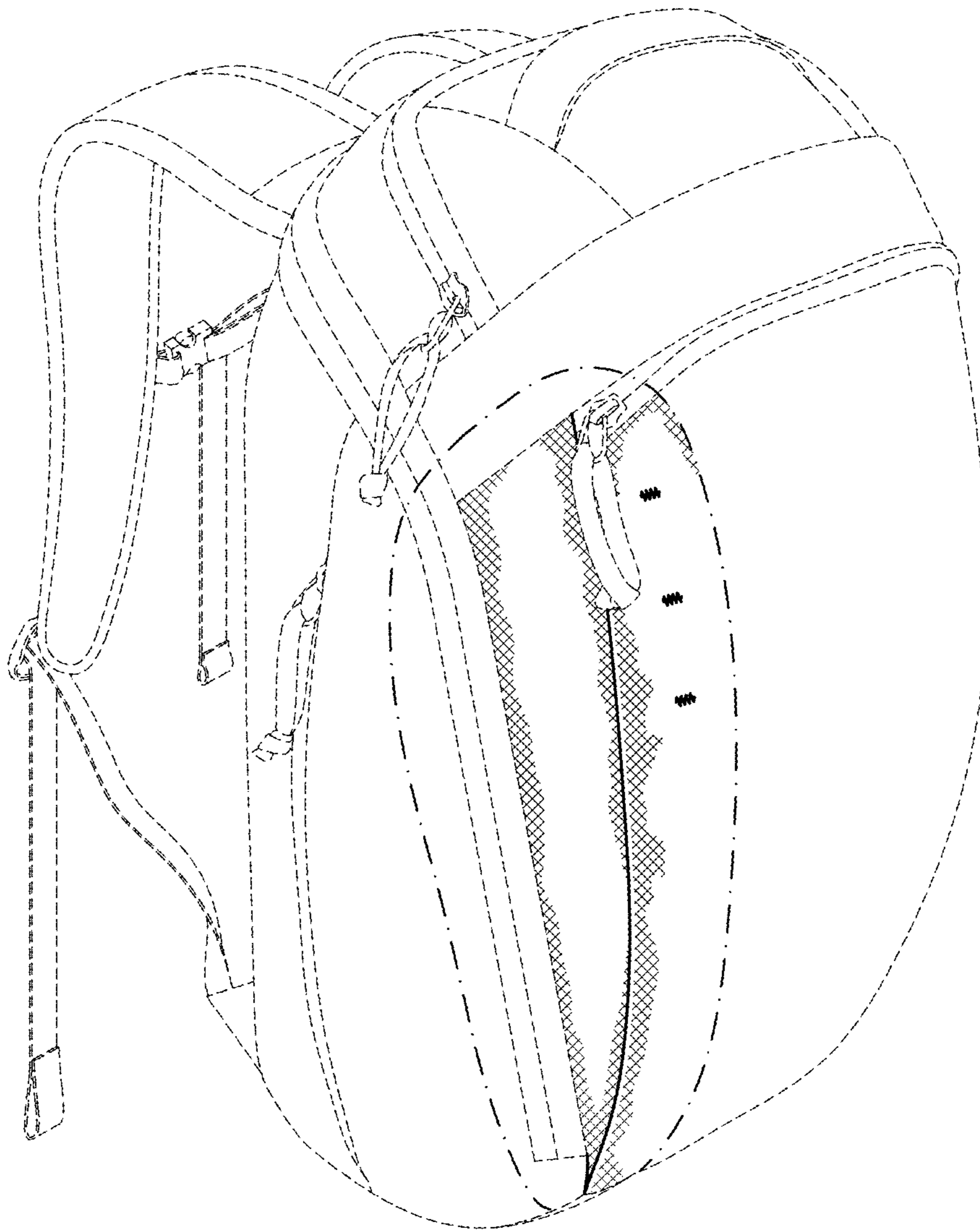

FIG.1

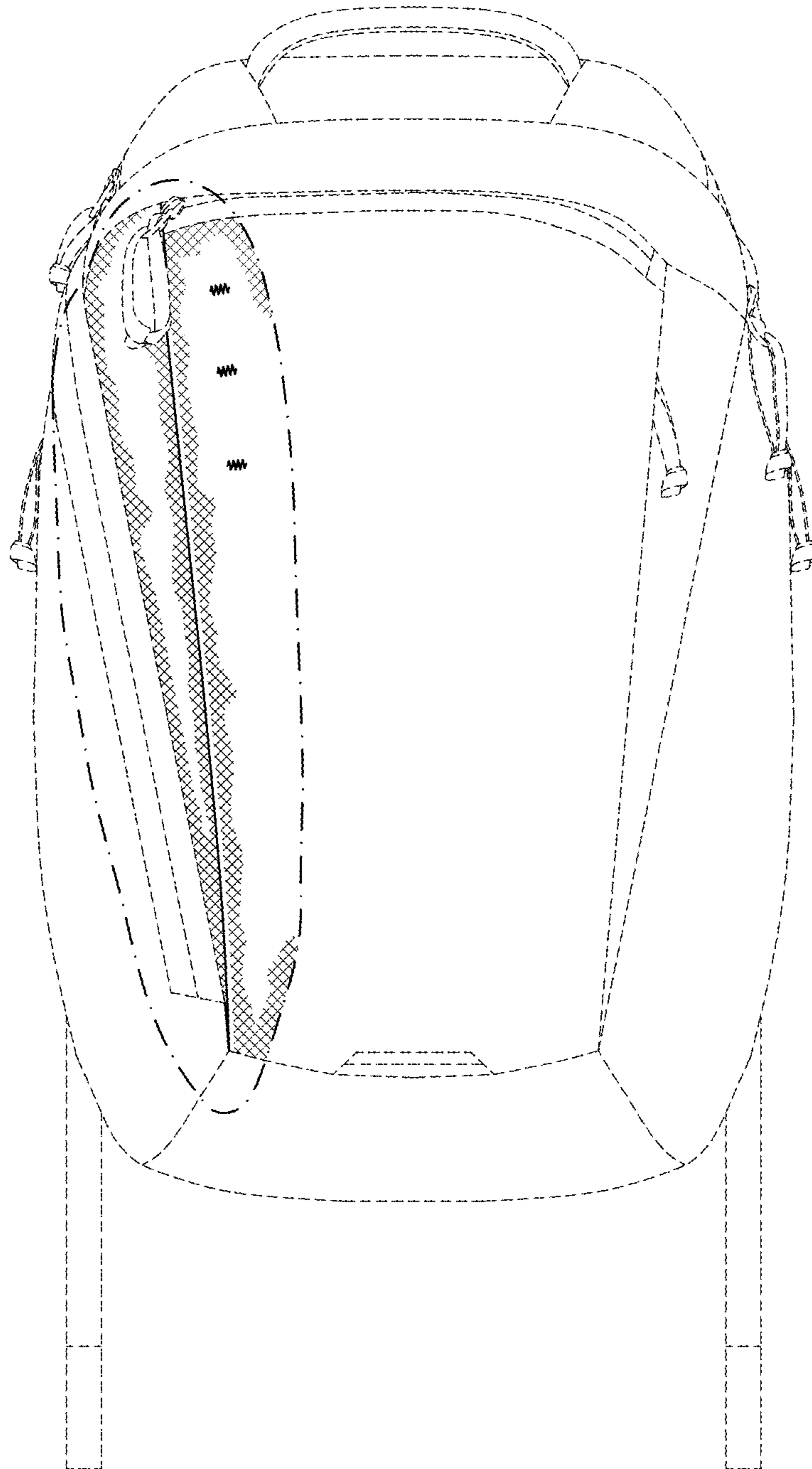

FIG.2

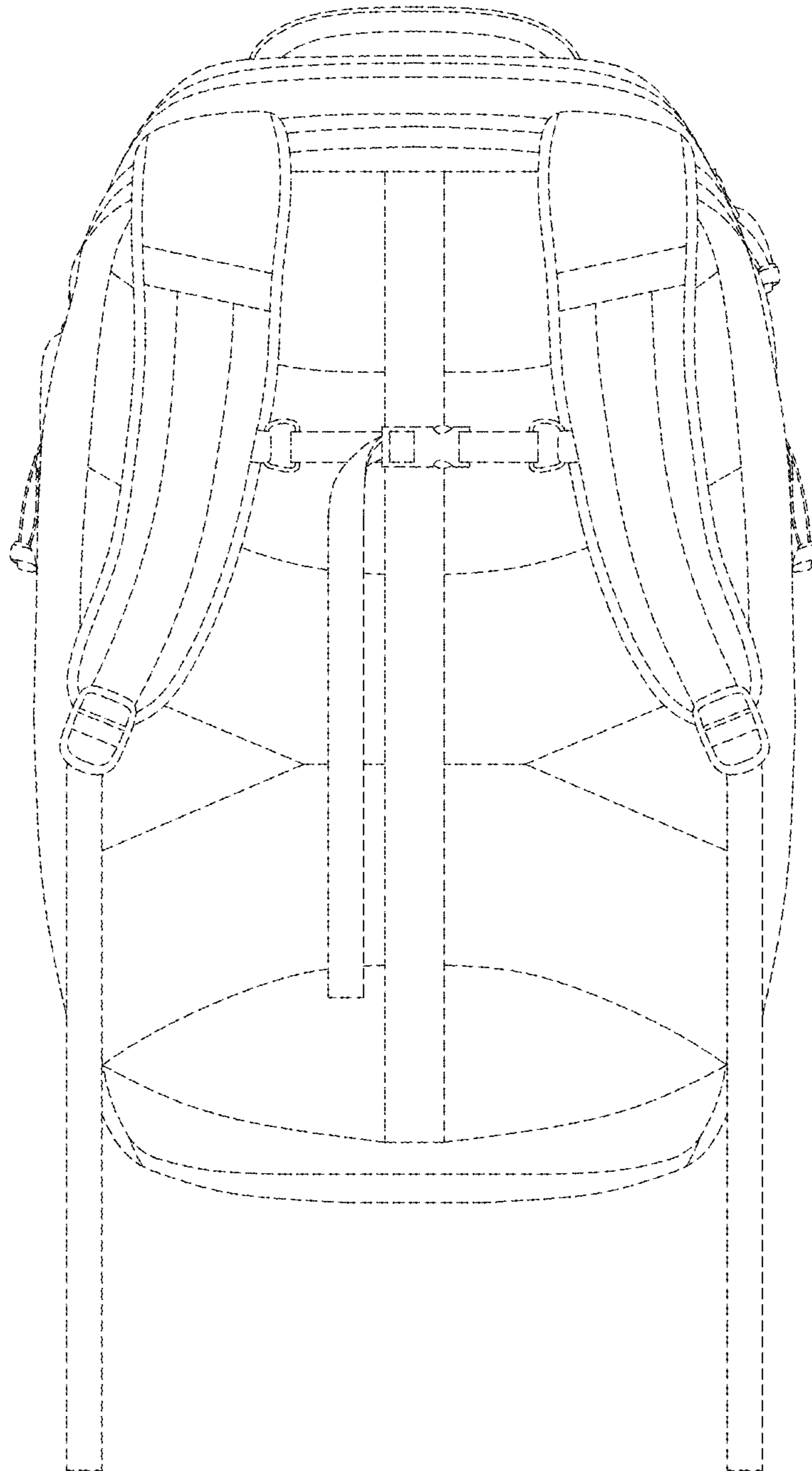

FIG.3

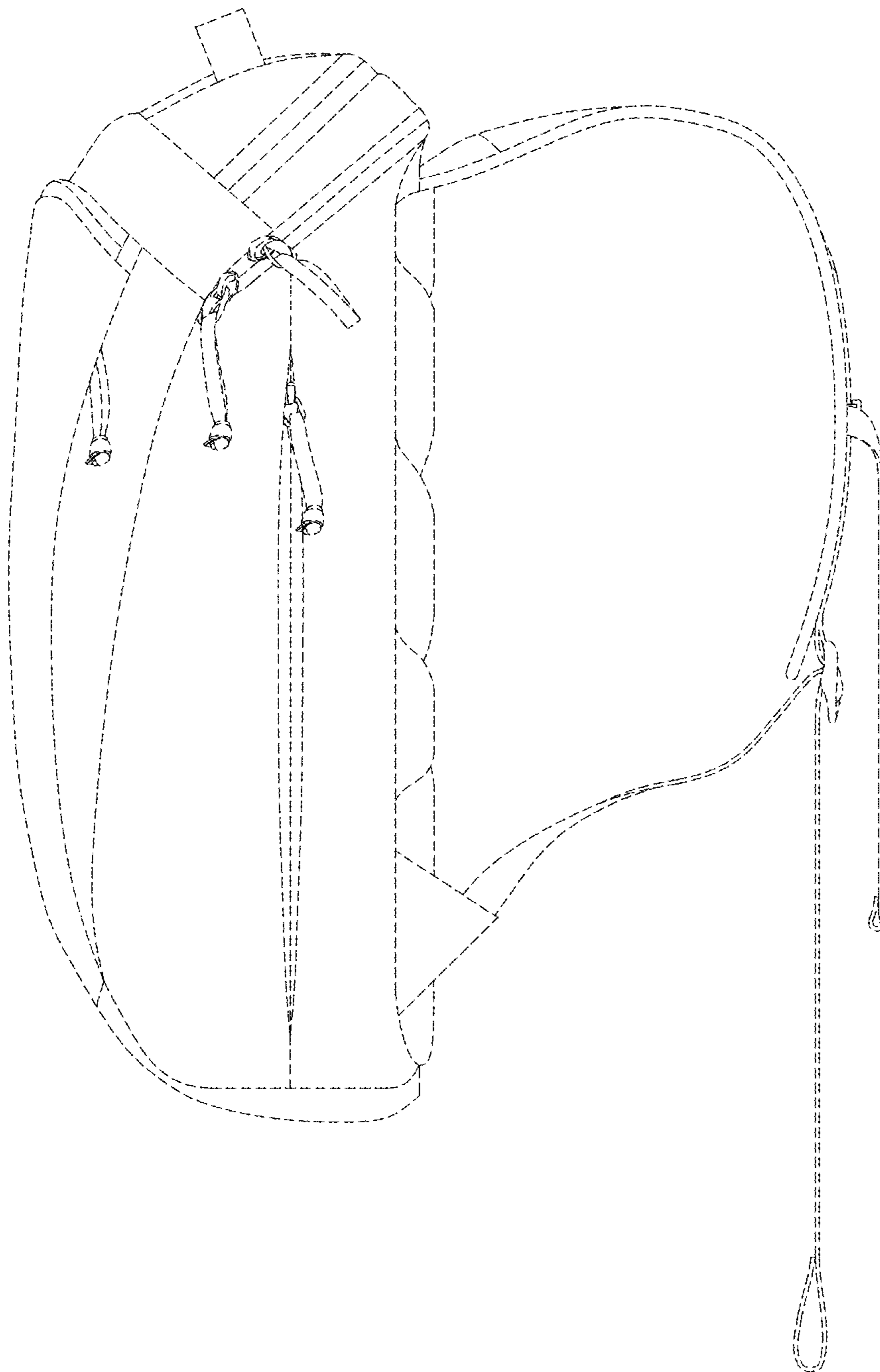

FIG.4

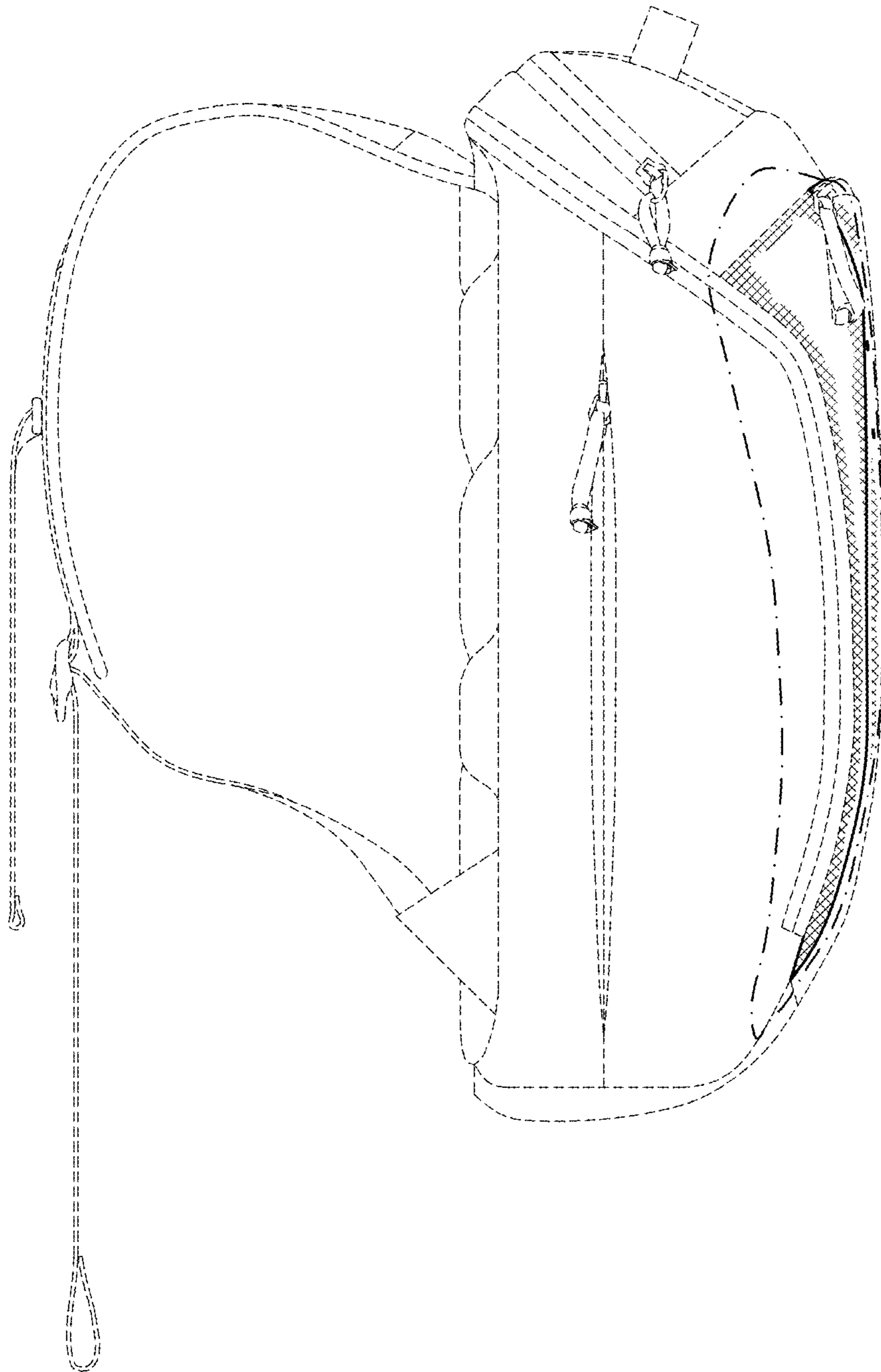

FIG.5

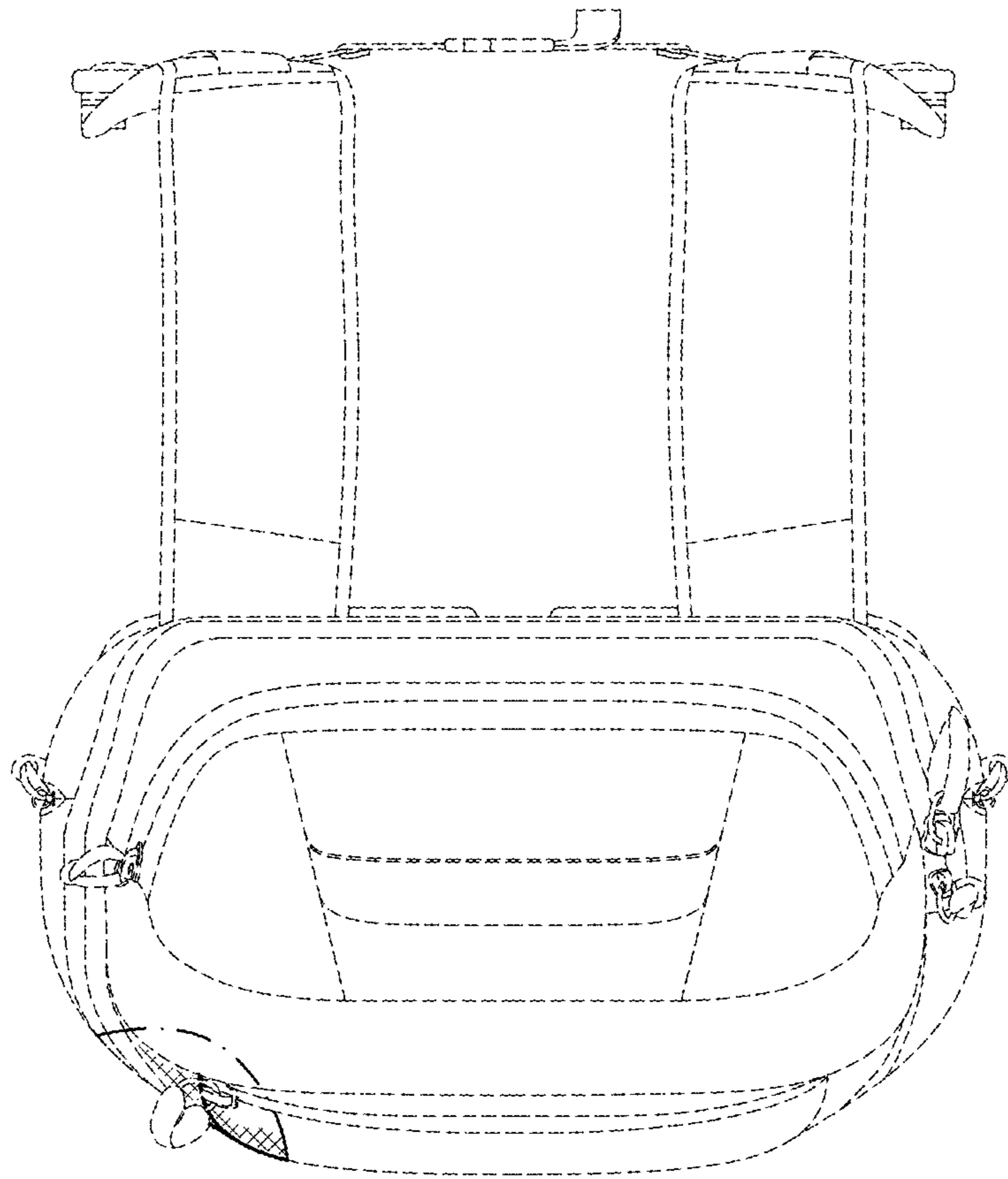

FIG.6

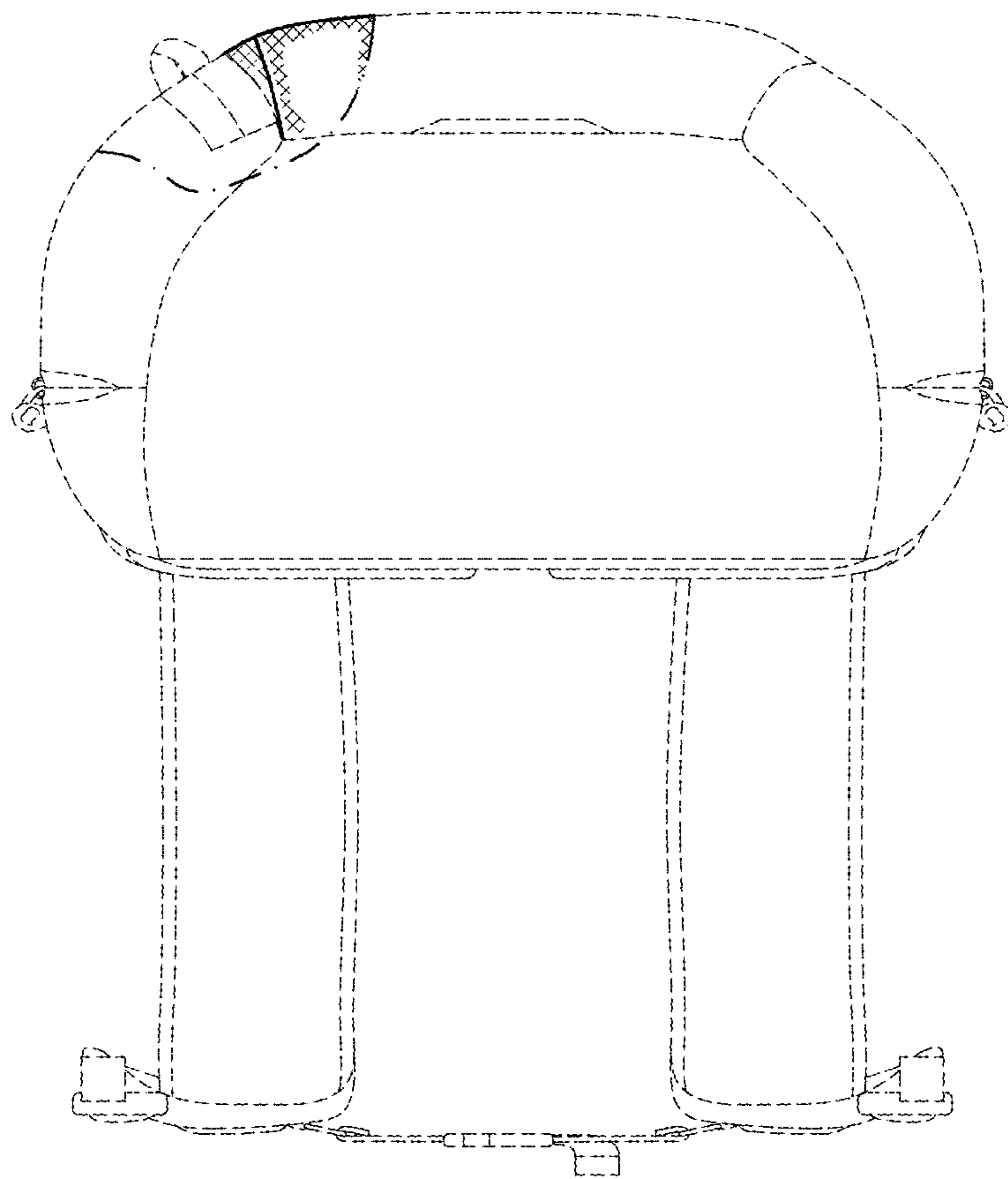

FIG. 7

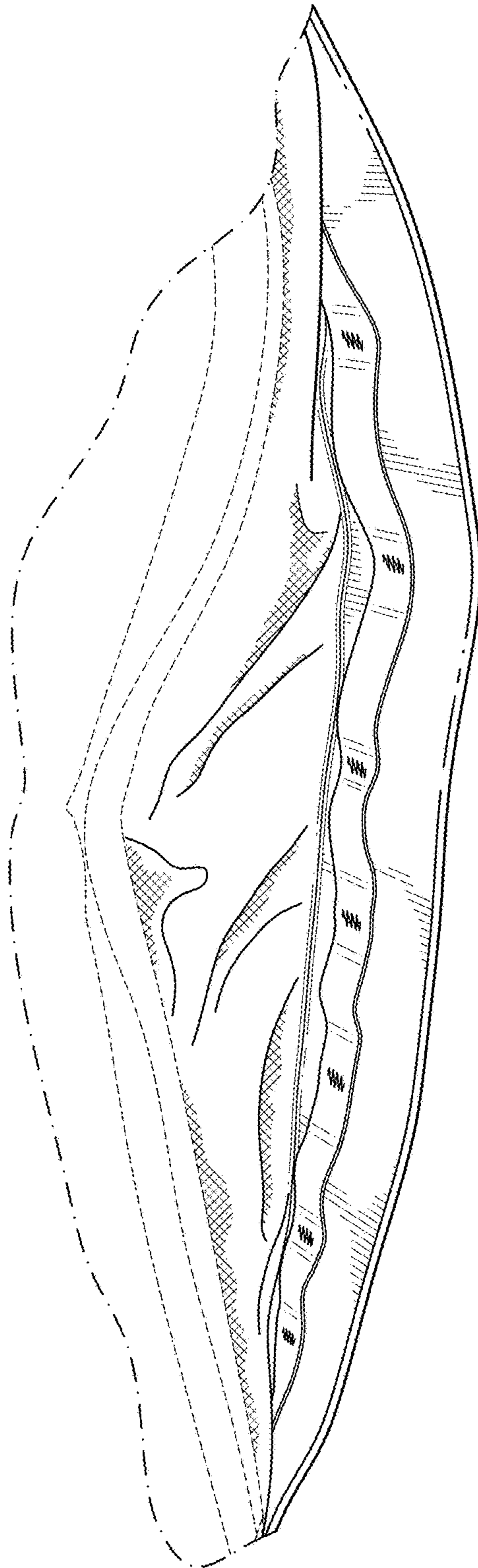

FIG.8