



US00D872981S

(12) **United States Design Patent**  
**Hooper et al.**

(10) **Patent No.:** **US D872,981 S**

(45) **Date of Patent:** **\*\* Jan. 21, 2020**

(54) **FOOTWEAR WITH STRAP CLOSURE**

(71) Applicant: **FACTOR 10 LLC**, New Orleans, LA (US)

(72) Inventors: **Luke Hooper**, New Orleans, LA (US);  
**Ben Weisgerber**, New Orleans, LA (US);  
**Abigail Willets**, New Orleans, LA (US)

(73) Assignee: **Factor 10 LLC**, New Orleans, LA (US)

(\*\*) Term: **15 Years**

(21) Appl. No.: **29/664,459**

(22) Filed: **Sep. 25, 2018**

(51) **LOC (12) Cl.** ..... **02-04**

(52) **U.S. Cl.**  
USPC ..... **D2/943; D2/907; D2/896**

(58) **Field of Classification Search**  
USPC ..... D2/896-900, 909-911, 920, 943, 946,  
D2/969, 970, 974  
CPC ..... A43B 23/00; A43B 23/02; A43B 13/00;  
A43B 3/16  
See application file for complete search history.

(56) **References Cited**

**U.S. PATENT DOCUMENTS**

1,686,175	A	10/1928	Read	
1,793,212	A	2/1931	Dike	
3,436,842	A	4/1969	Sachs	
4,114,296	A	9/1978	Smith	
4,136,468	A *	1/1979	Munschy	..... A43B 3/26 36/97

(Continued)

**FOREIGN PATENT DOCUMENTS**

DE	20112330	U1	12/2001
DE	102009023689	A1	12/2010

(Continued)

**OTHER PUBLICATIONS**

Susan Anderson: "Vedante PO Bands™. Fun and sfatey for Halloween: Supre-Reflective, Colorful Way to Make goblins Visible to Cars at Night" Oct. 8, 2014 <http://www.prweb.com/releases/halloween/2014/prweb12225212.htm>.

*Primary Examiner* — Rashida C. Walshon  
(74) *Attorney, Agent, or Firm* — Jason P. Mueller; Adams and Reese LLP

(57) **CLAIM**

The ornamental design for footwear with strap closure, as shown and described.

**DESCRIPTION**

FIG. 1 is a top perspective view of footwear with strap closure in a closed position;  
FIG. 2 is a front view thereof;  
FIG. 3 is a back view thereof;  
FIG. 4 is a left side view thereof;  
FIG. 5 is a right side view thereof;  
FIG. 6 is a top view thereof;  
FIG. 7 is a bottom view thereof;  
FIG. 8 is a top perspective view of an embodiment with a strap closure in an open position;  
FIG. 9 is a front view thereof;  
FIG. 10 is a back view thereof;  
FIG. 11 is a left side view thereof;  
FIG. 12 is a right side view thereof;  
FIG. 13 is a top view thereof;  
FIG. 14 is a bottom view thereof;  
FIG. 15 is a top perspective view of a second embodiment with a strap closure in an open position;  
FIG. 16 is a front view thereof;  
FIG. 17 is a back view thereof;  
FIG. 18 is a left side view thereof;  
FIG. 19 is a right side view thereof;  
FIG. 20 is a top view thereof; and,  
FIG. 21 is a bottom view thereof.

**1 Claim, 14 Drawing Sheets**

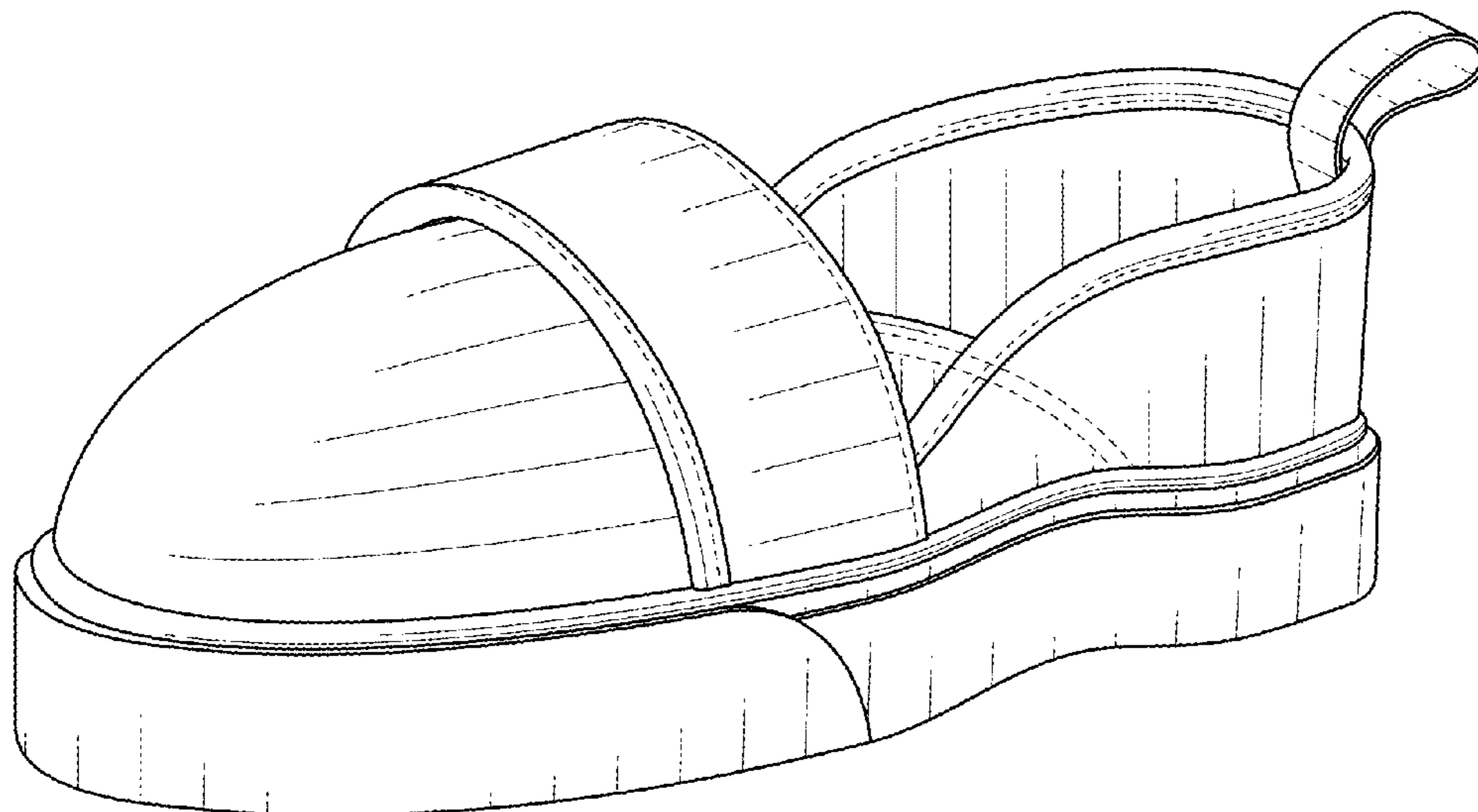

(56)

References Cited

U.S. PATENT DOCUMENTS

D274,290 S \* 6/1984 Migdow ..... D2/900  
 D274,291 S \* 6/1984 Migdow ..... D2/900  
 4,476,639 A 10/1984 Zaccaria  
 4,667,861 A 5/1987 Harrington et al.  
 4,670,999 A 6/1987 Olivieri  
 4,924,605 A 5/1990 Spademan  
 5,054,216 A 10/1991 Lin  
 D326,177 S \* 5/1992 Miller ..... D2/903  
 5,148,614 A 9/1992 Kelly  
 5,205,055 A 4/1993 Harrell  
 D342,145 S \* 12/1993 Yeh ..... D2/903  
 5,481,814 A 1/1996 Spencer  
 5,682,687 A 11/1997 Arai  
 5,839,210 A 11/1998 Bemier et al.  
 5,983,530 A 11/1999 Chou  
 5,991,950 A 11/1999 Schenkel  
 6,032,387 A 3/2000 Johnson  
 6,035,556 A 3/2000 Ballinger et al.  
 D437,474 S \* 2/2001 Agnew ..... D2/902  
 D438,972 S \* 3/2001 Darby ..... D2/943  
 6,351,897 B1 3/2002 Smith  
 6,378,230 B1 4/2002 Rotem et al.  
 6,427,361 B1 8/2002 Chou  
 6,739,615 B1 5/2004 Maravetz et al.  
 6,896,128 B1 5/2005 Johnson  
 7,059,069 B2 6/2006 Raluy et al.  
 D534,712 S \* 1/2007 Darby, II ..... D2/896  
 7,178,270 B2 2/2007 Hurd et al.  
 7,581,337 B2 9/2009 Miller et al.  
 7,793,438 B1 9/2010 Busse et al.  
 8,001,704 B2 8/2011 Baudouin  
 D649,757 S \* 12/2011 Walton ..... D2/929  
 8,087,188 B2 1/2012 Labbe  
 8,161,669 B2 \* 4/2012 Keating ..... A43B 1/0081  
 36/102  
 8,225,530 B2 \* 7/2012 Sokolowski ..... A43B 3/0031  
 36/9 R  
 8,499,474 B2 8/2013 Kaufman  
 D718,024 S \* 11/2014 Wells ..... D2/943

9,044,063 B2 \* 6/2015 Loverin ..... A43B 3/30  
 9,254,018 B2 2/2016 Bliss  
 9,392,844 B1 7/2016 Burrell  
 9,414,640 B2 8/2016 Nichols  
 D796,163 S \* 9/2017 Lee ..... D2/902  
 2001/0034958 A1 11/2001 Kaneko et al.  
 2002/0035795 A1 3/2002 Smith  
 2003/0009917 A1 1/2003 Voswinkel  
 2003/0145490 A1 8/2003 Tsai  
 2004/0072482 A1 4/2004 Runyan  
 2005/0039348 A1 2/2005 Raluy et al.  
 2005/0081404 A1 4/2005 Hurd et al.  
 2005/0102864 A1 5/2005 Levy et al.  
 2007/0209234 A1 9/2007 Chou  
 2008/0086911 A1 4/2008 Labbe  
 2008/0307673 A1 12/2008 Johnson  
 2009/0019736 A1 1/2009 Ng et al.  
 2009/0223084 A1 9/2009 Kaufman  
 2009/0272007 A1 11/2009 Beers et al.  
 2011/0146106 A1 6/2011 Kaufman  
 2011/0258876 A1 10/2011 Baker et al.  
 2013/0219751 A1 8/2013 Catlett  
 2014/0338225 A1 11/2014 Bliss  
 2015/0003047 A1 1/2015 Lin  
 2015/0216252 A1 8/2015 Wiens  
 2016/0058128 A1 3/2016 Dalton  
 2016/0073739 A1 3/2016 James et al.  
 2016/0143397 A1 5/2016 Alvarez  
 2016/0214332 A1 7/2016 Zhao  
 2016/0302530 A1 10/2016 Smith et al.  
 2016/0345695 A1 12/2016 Stagge  
 2017/0027275 A1 2/2017 Nava  
 2017/0055642 A1 3/2017 Krengel

FOREIGN PATENT DOCUMENTS

EP 1952715 A1 8/2008  
 KR 1020170016170 A 4/2017  
 WO 03039283 A1 5/2003  
 WO 2009134858 A1 11/2009

\* cited by examiner

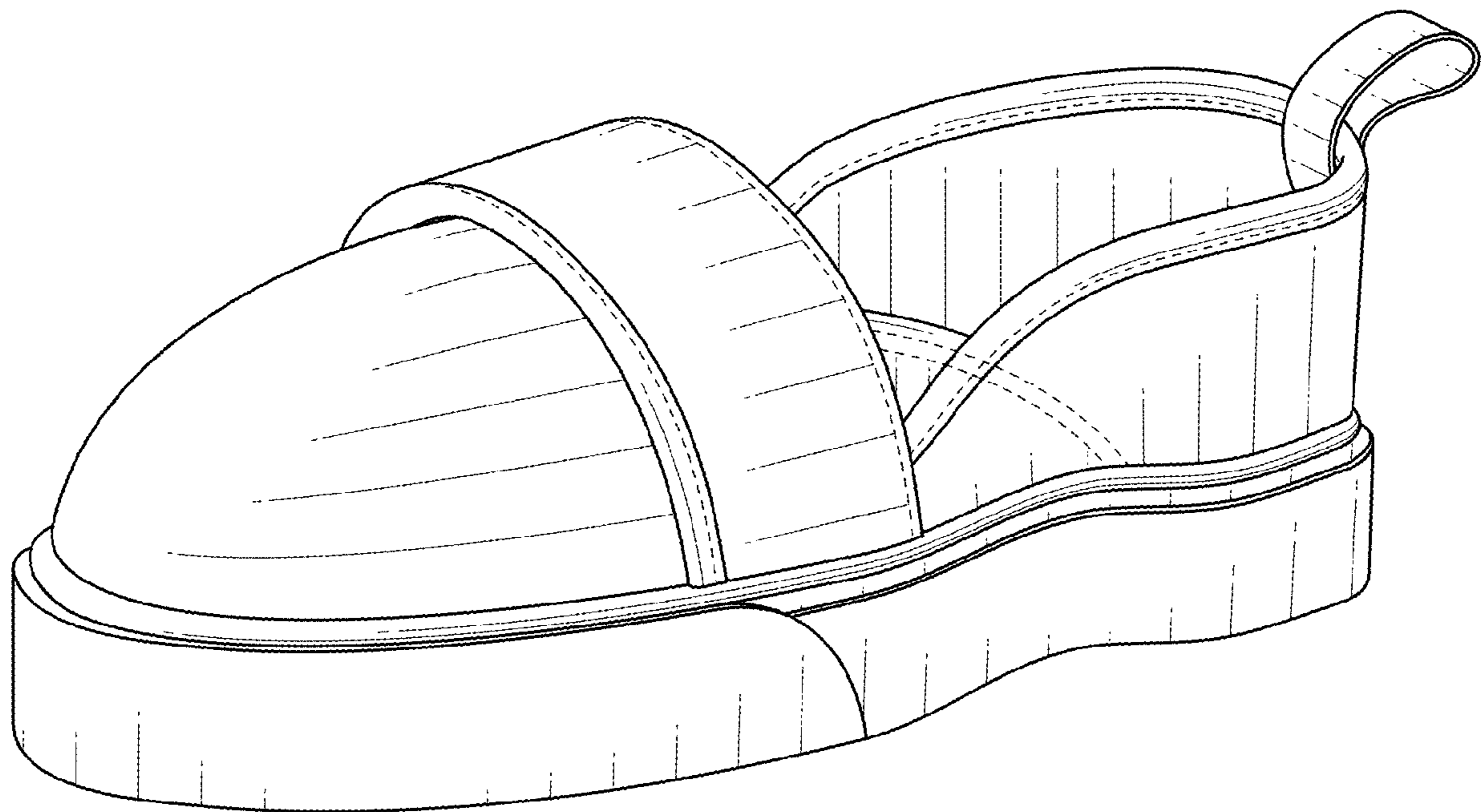

FIG. 1

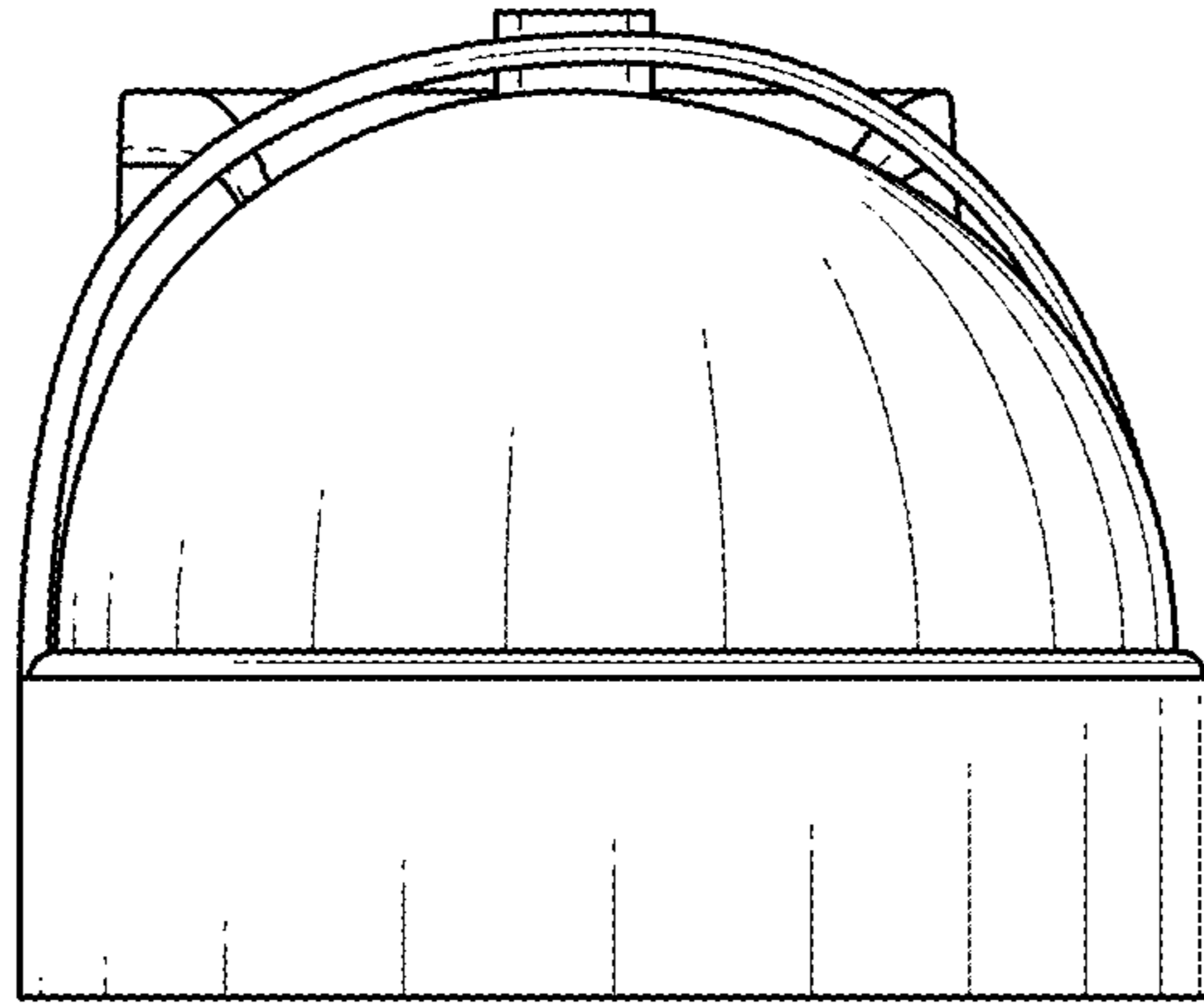

FIG. 2

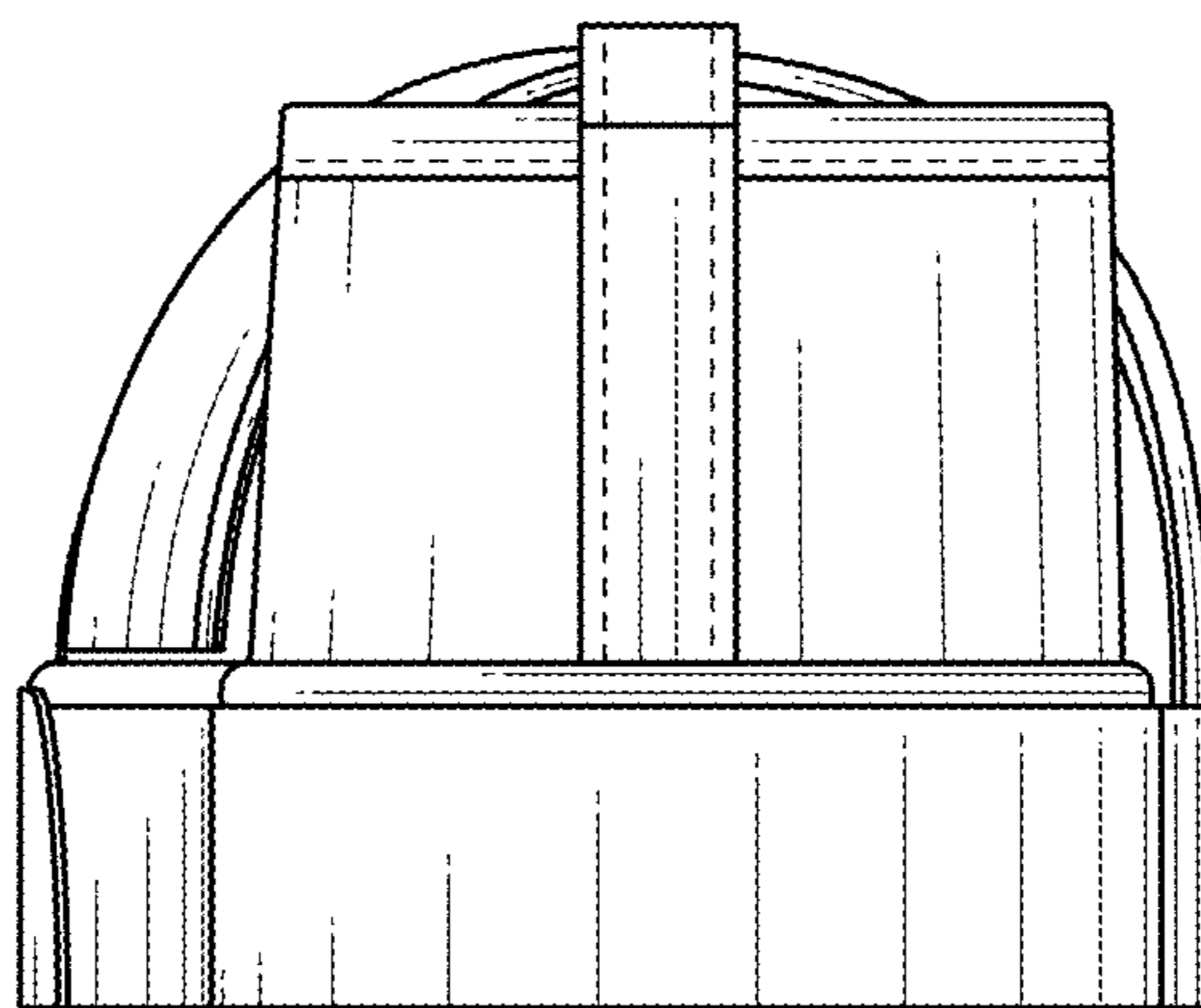

FIG. 3

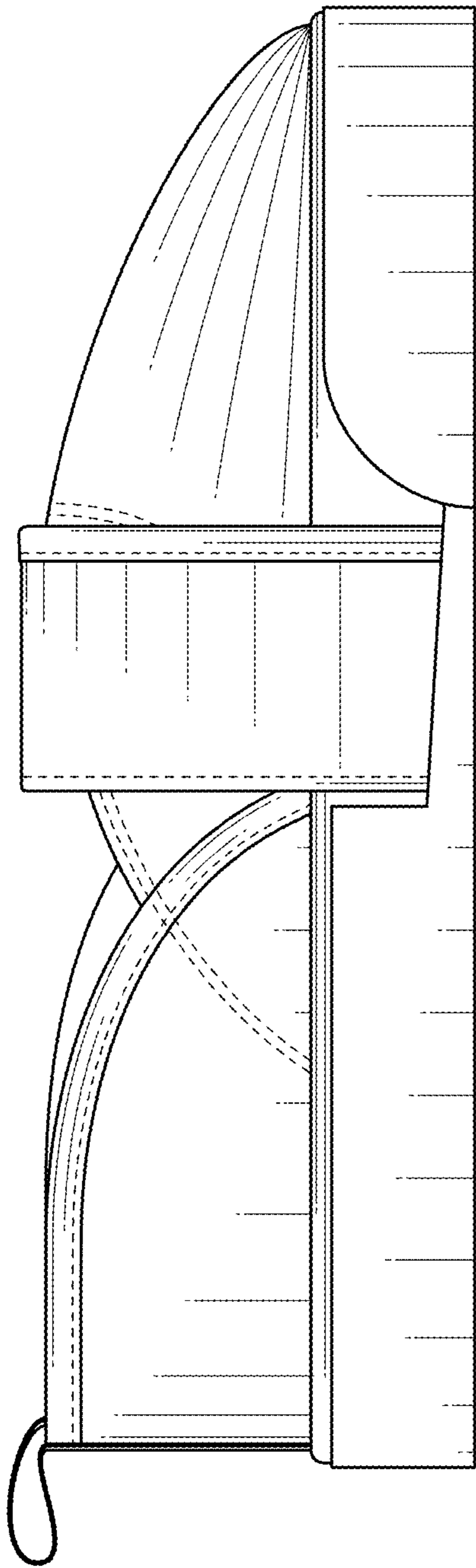

FIG. 4

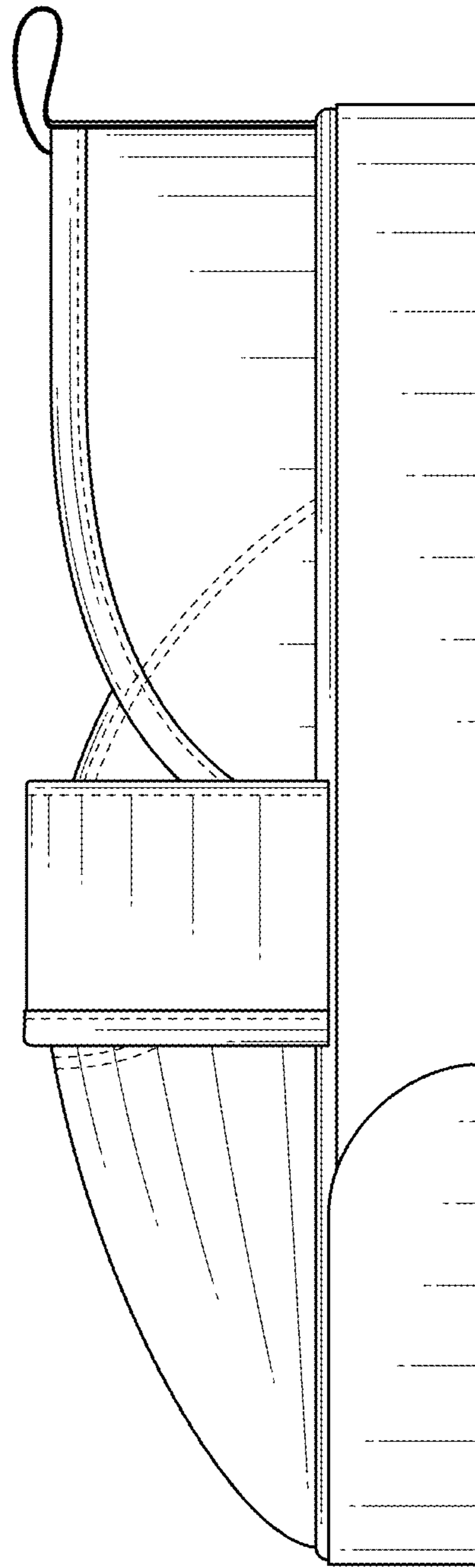

FIG. 5

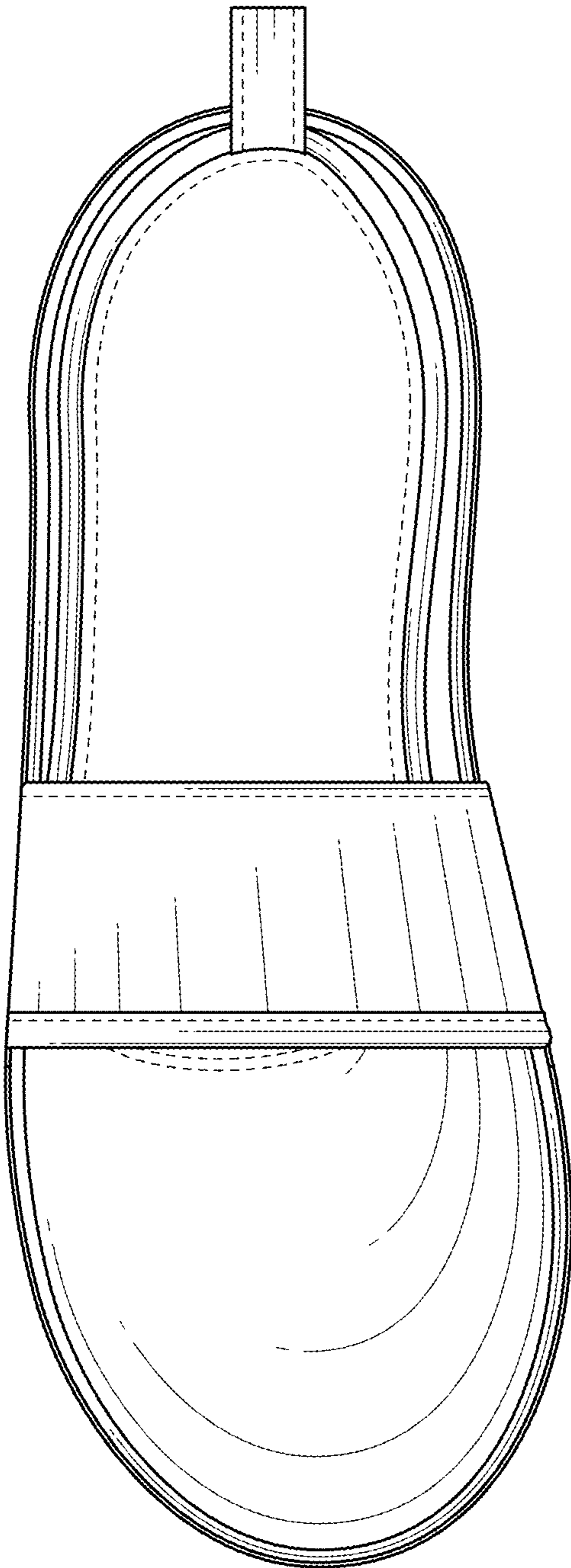

FIG. 6

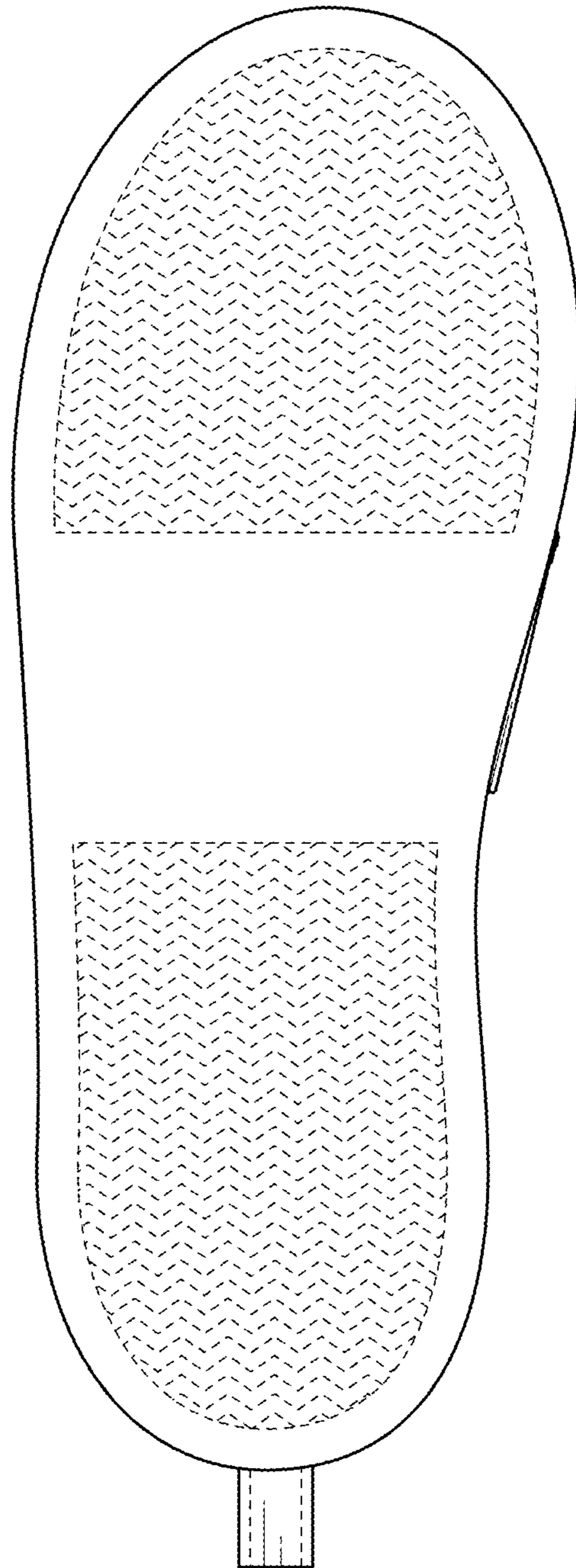

FIG. 7

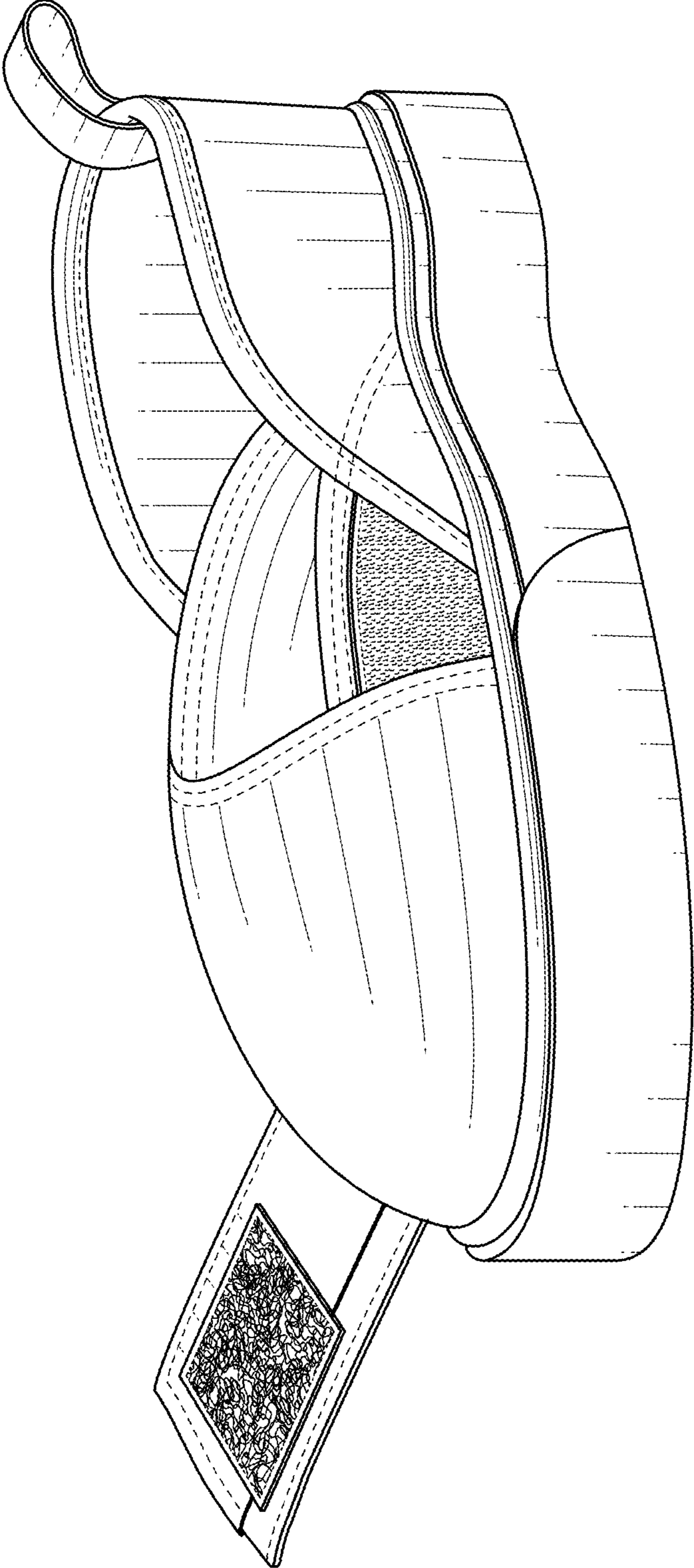

FIG. 8

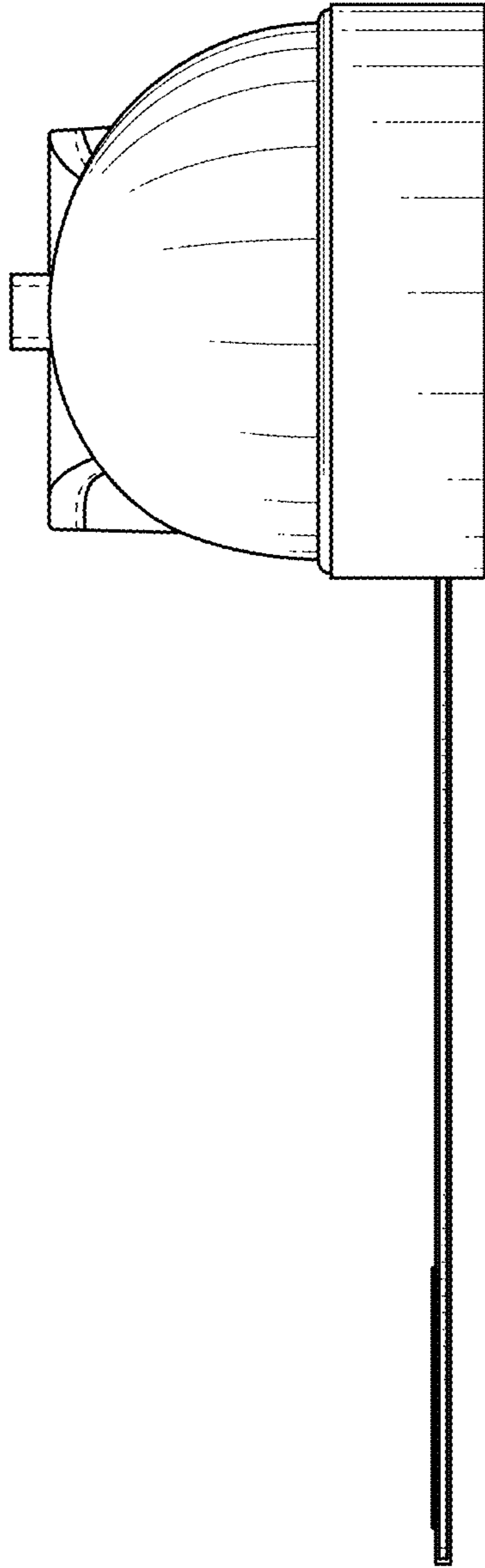

FIG. 9

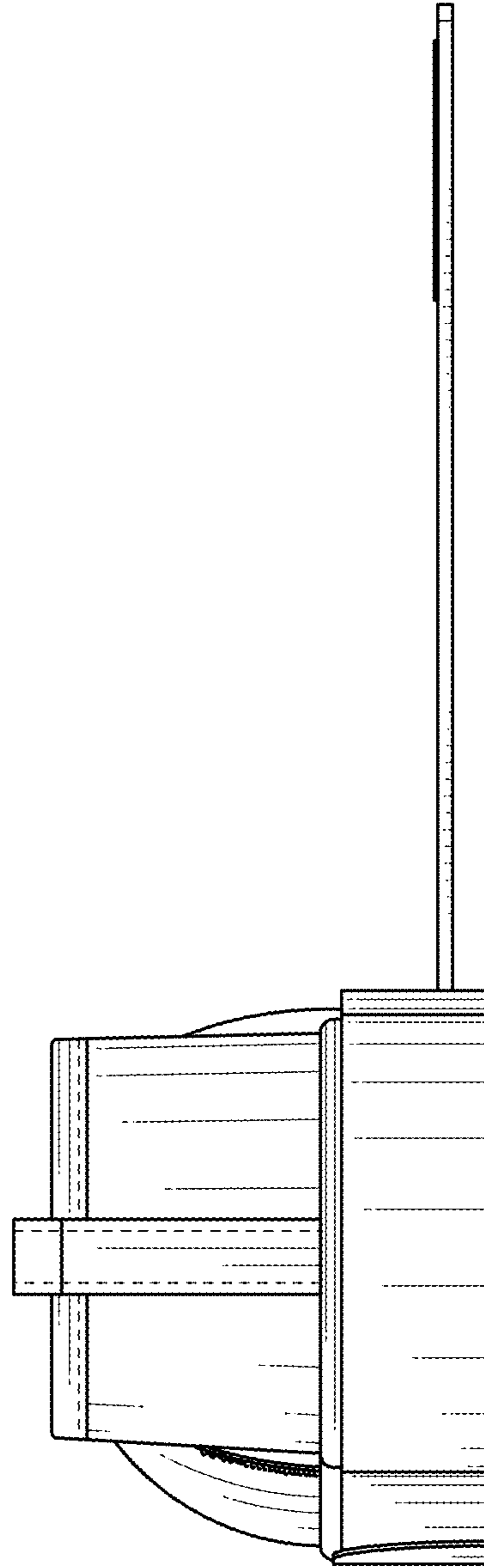

FIG. 10



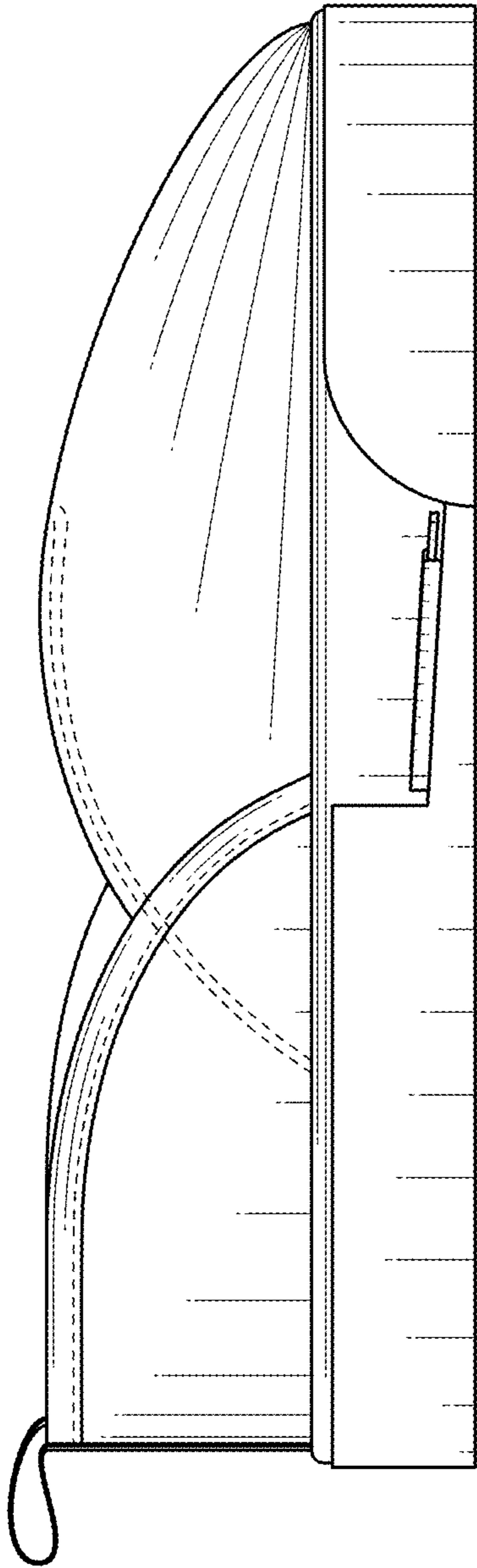

FIG. 11

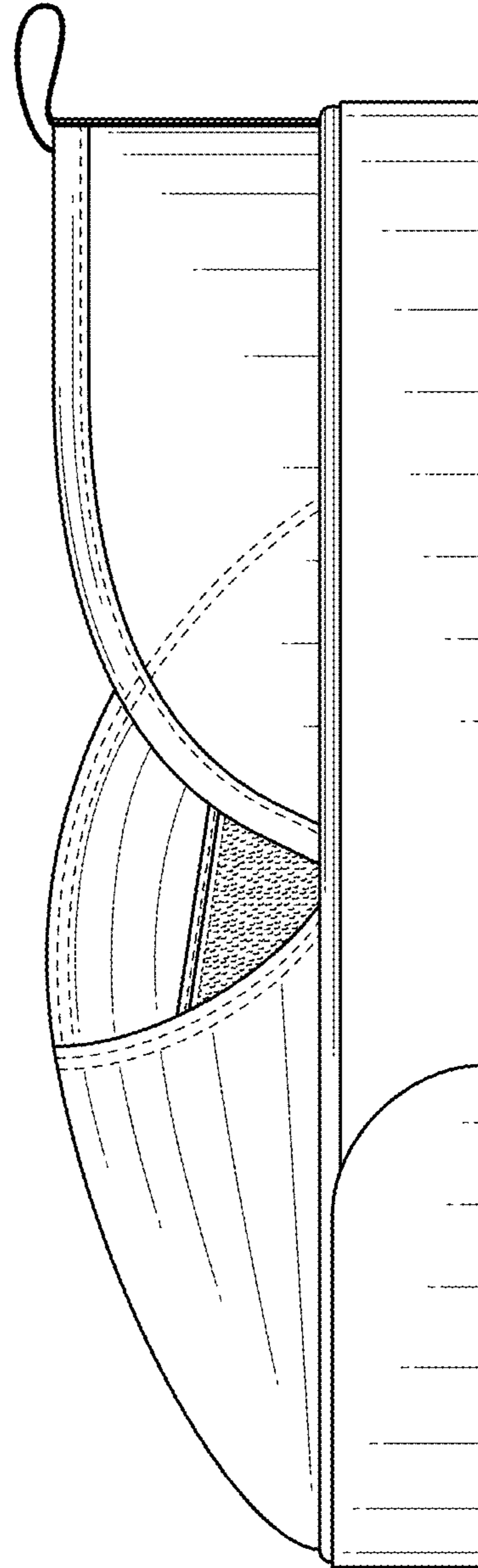

FIG. 12

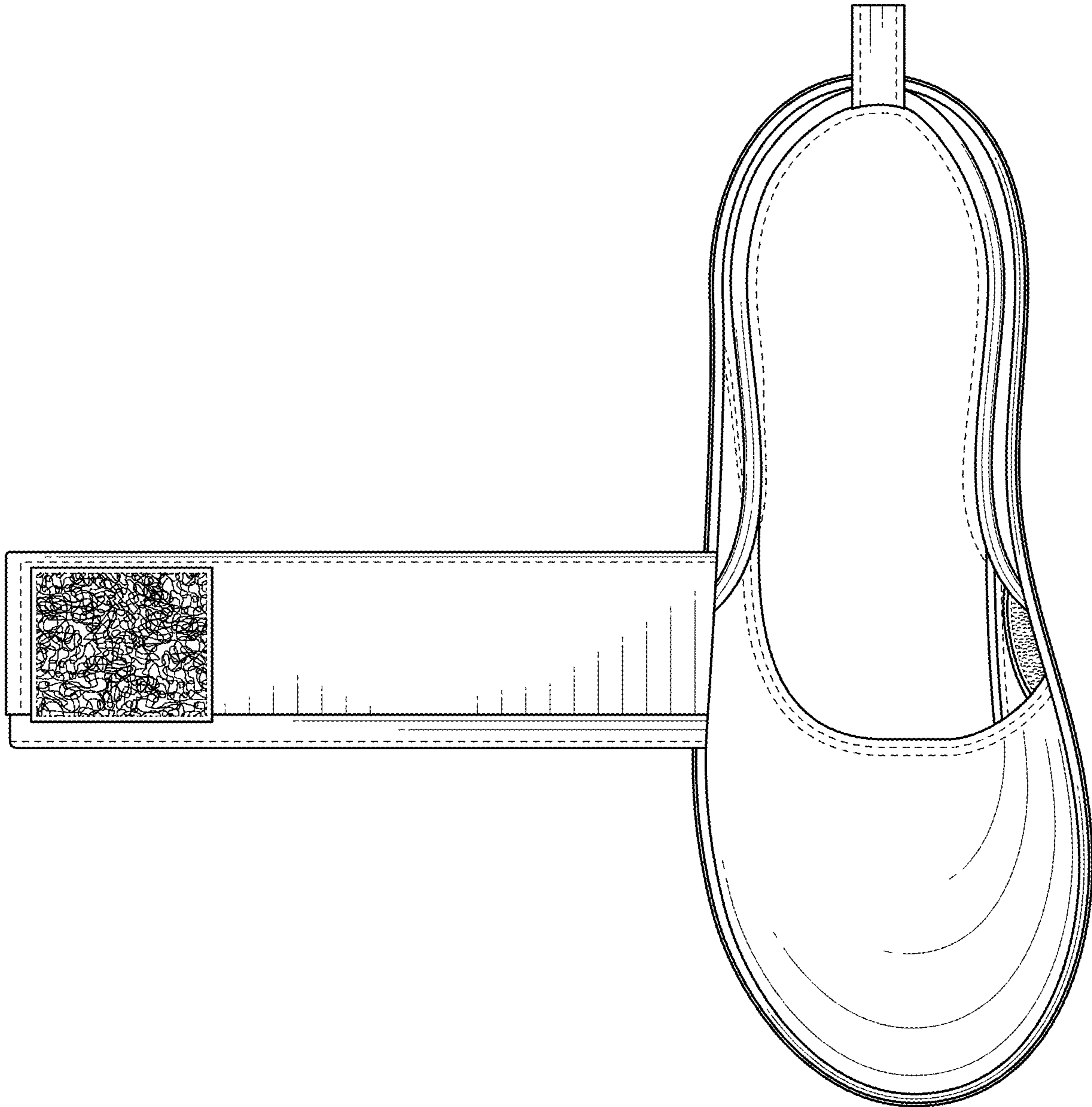

FIG. 13

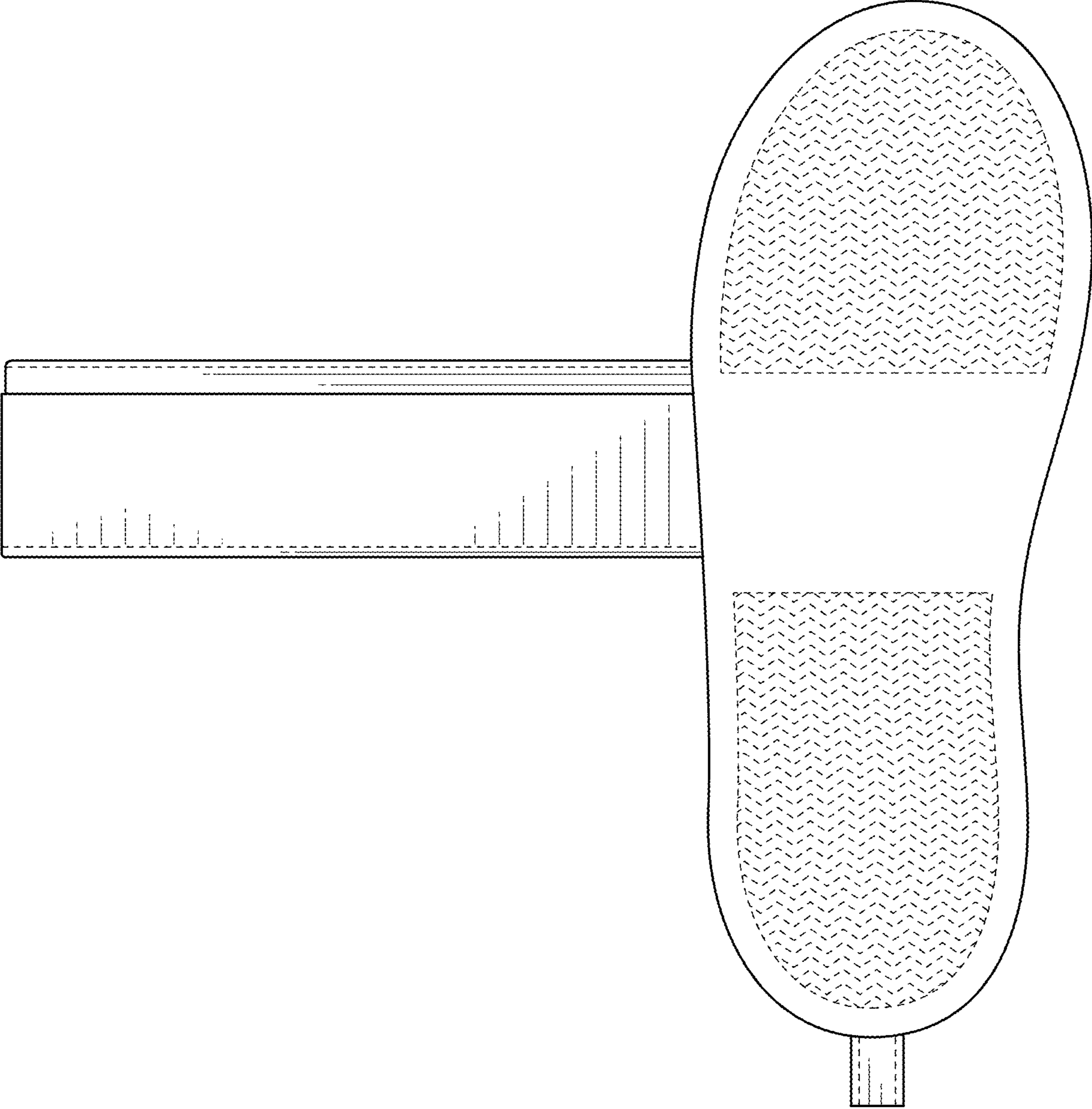

FIG. 14

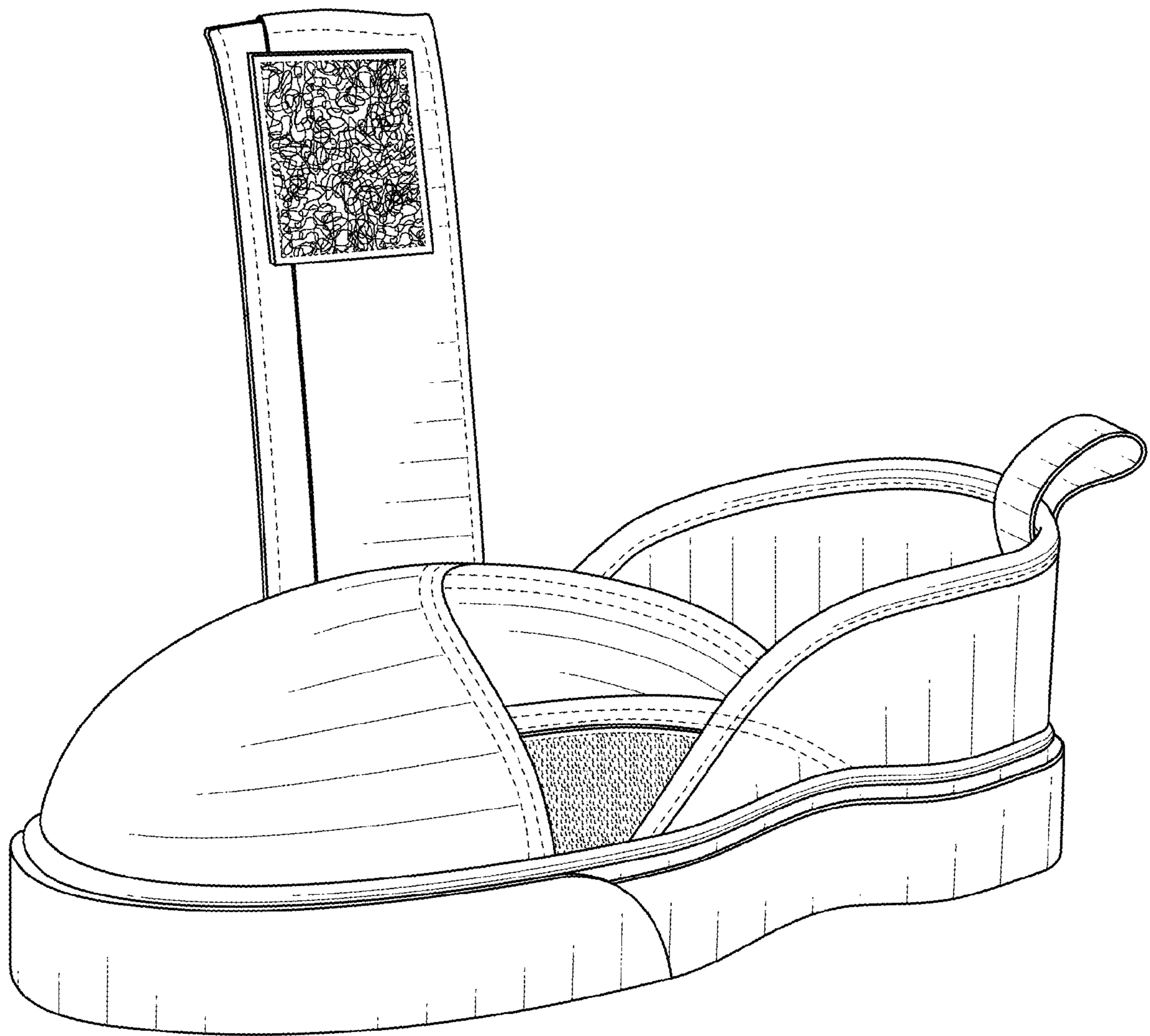

FIG. 15

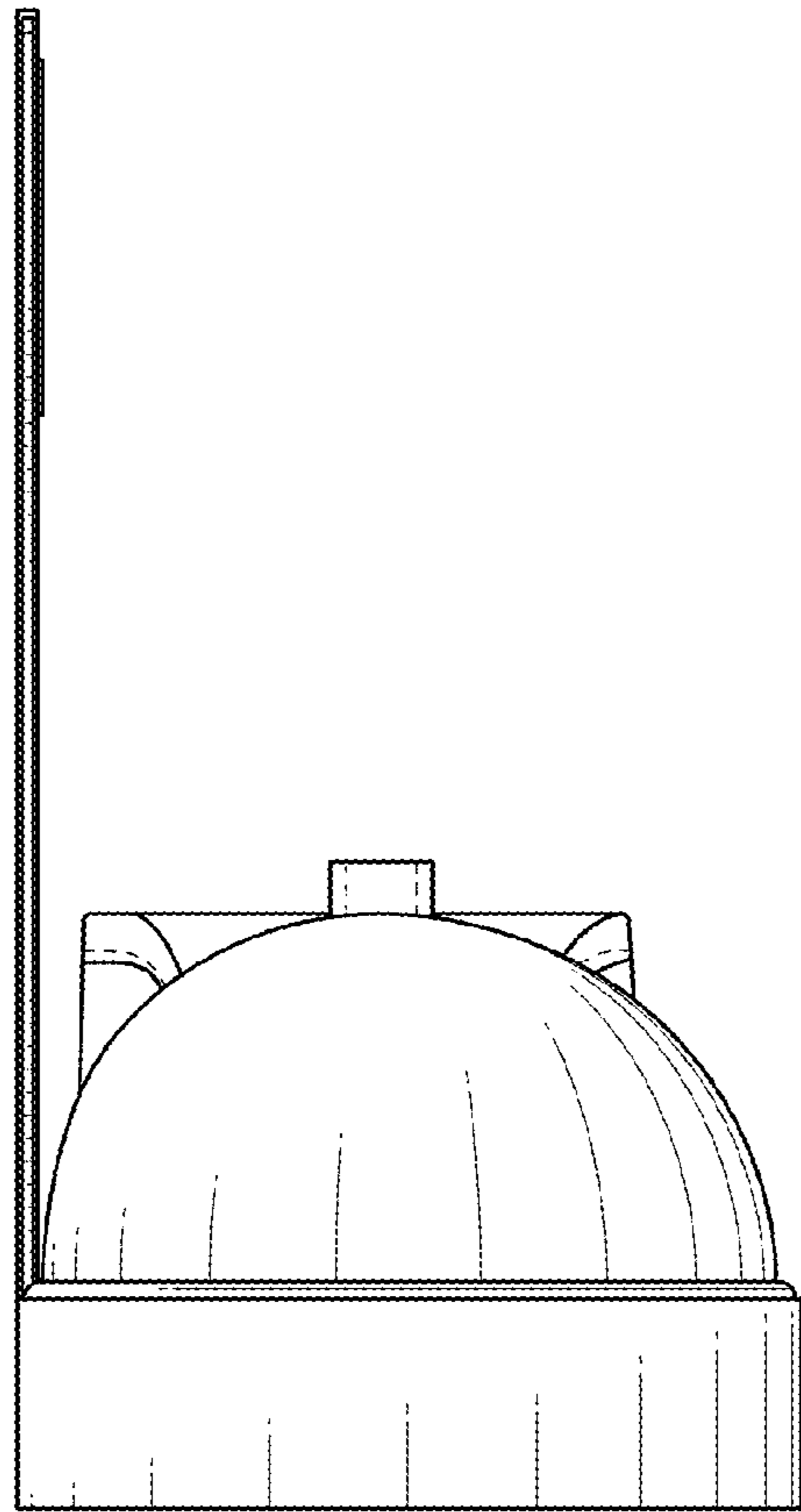

FIG. 16

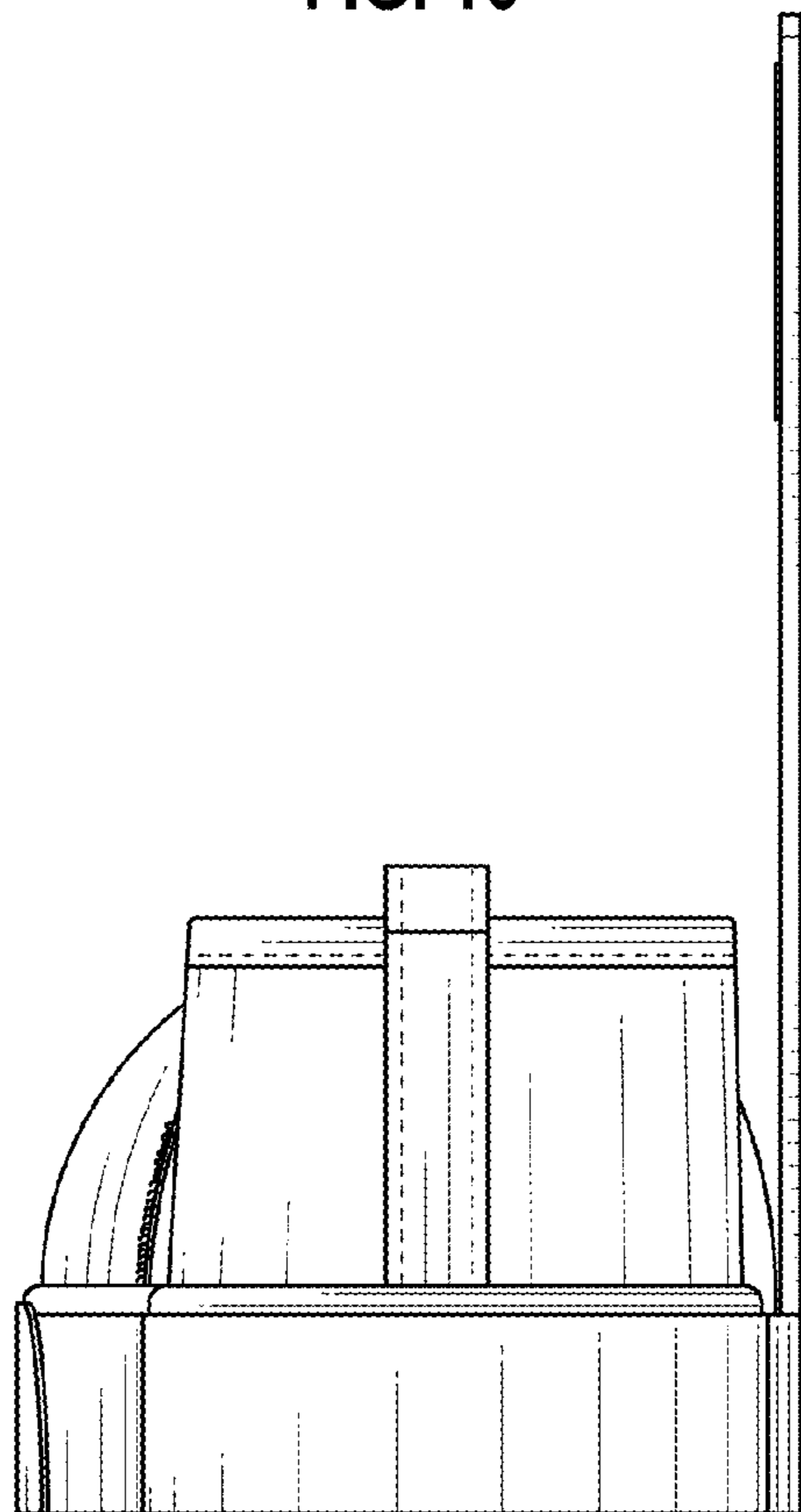

FIG. 17

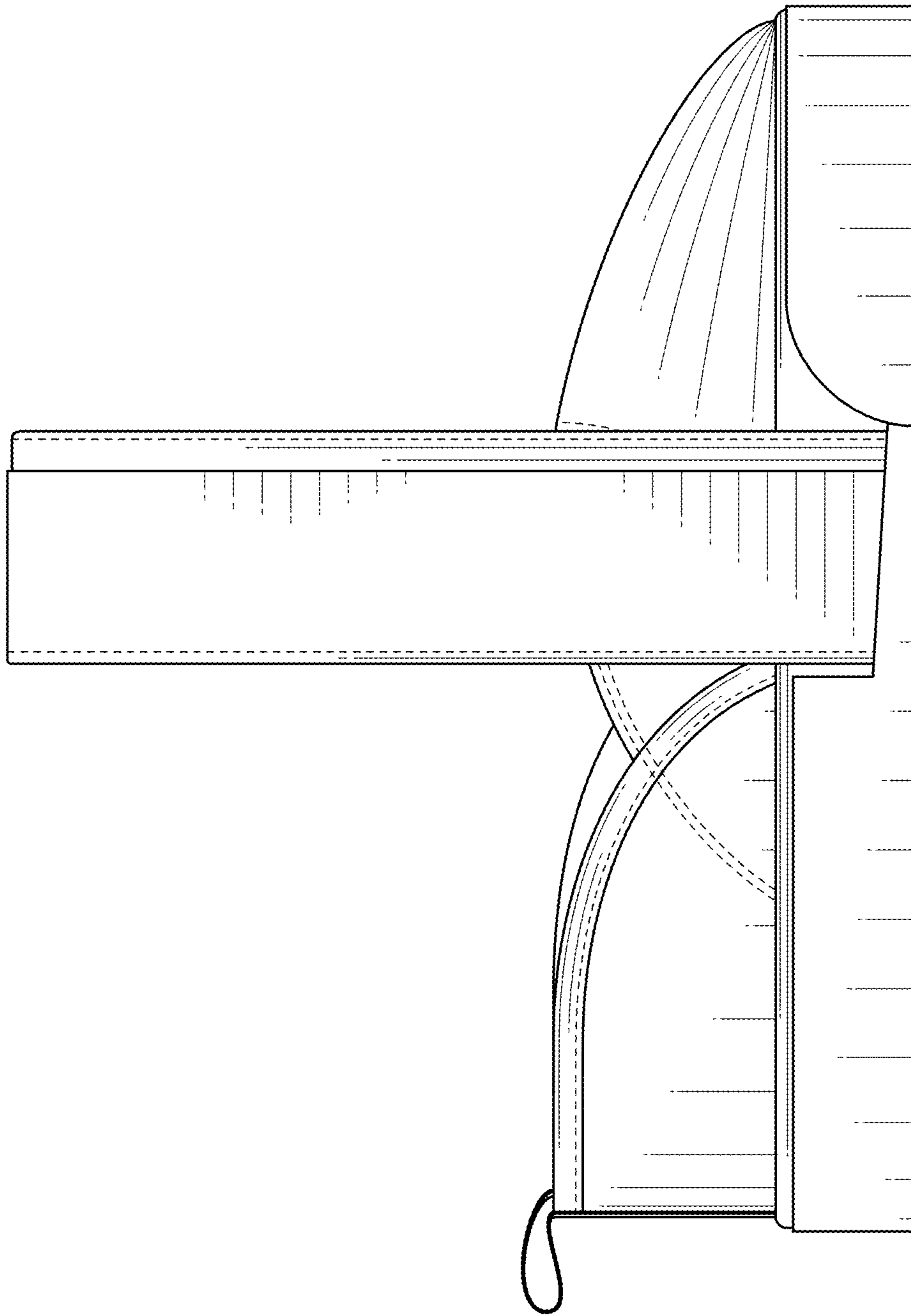

FIG. 18

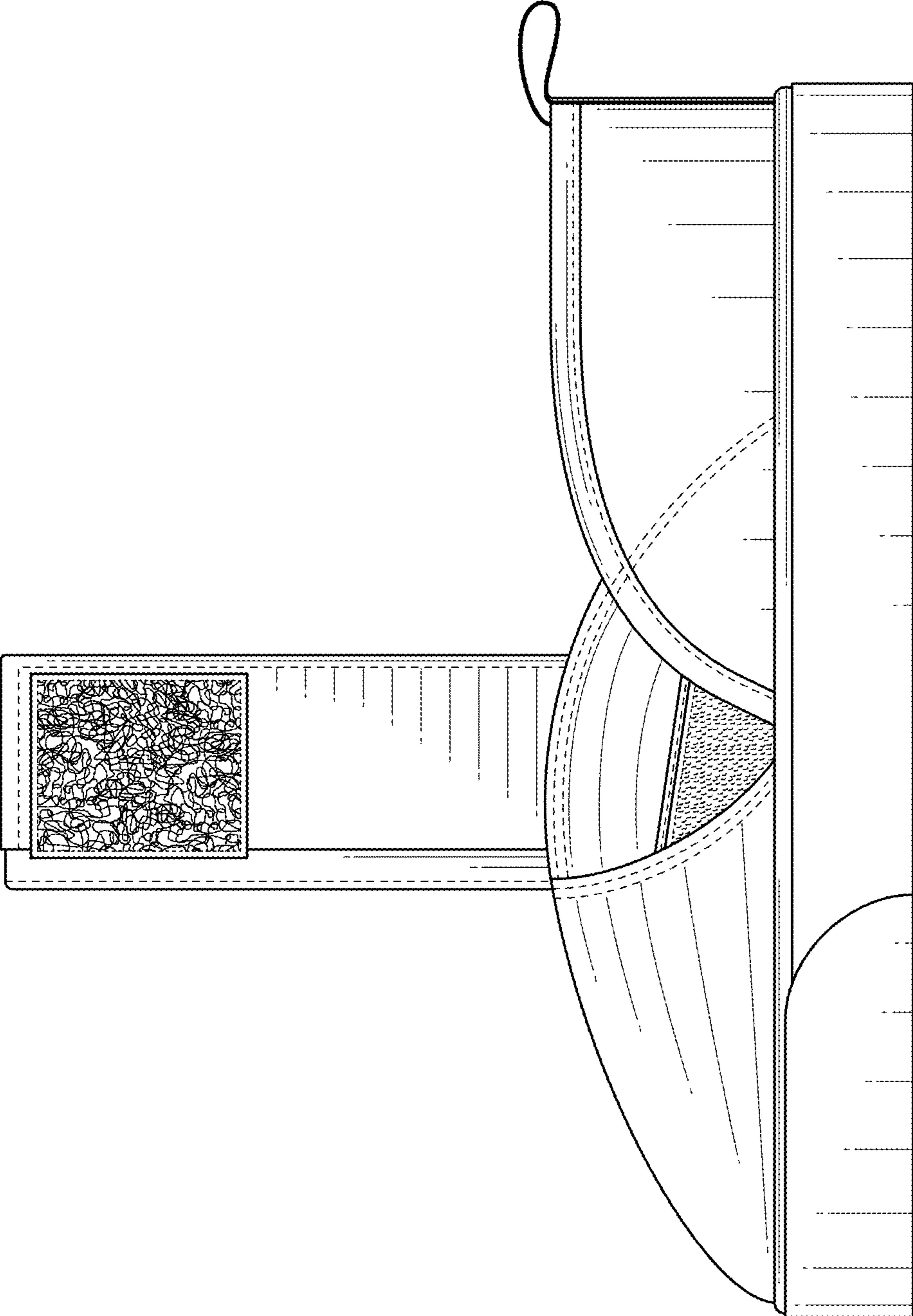

FIG. 19

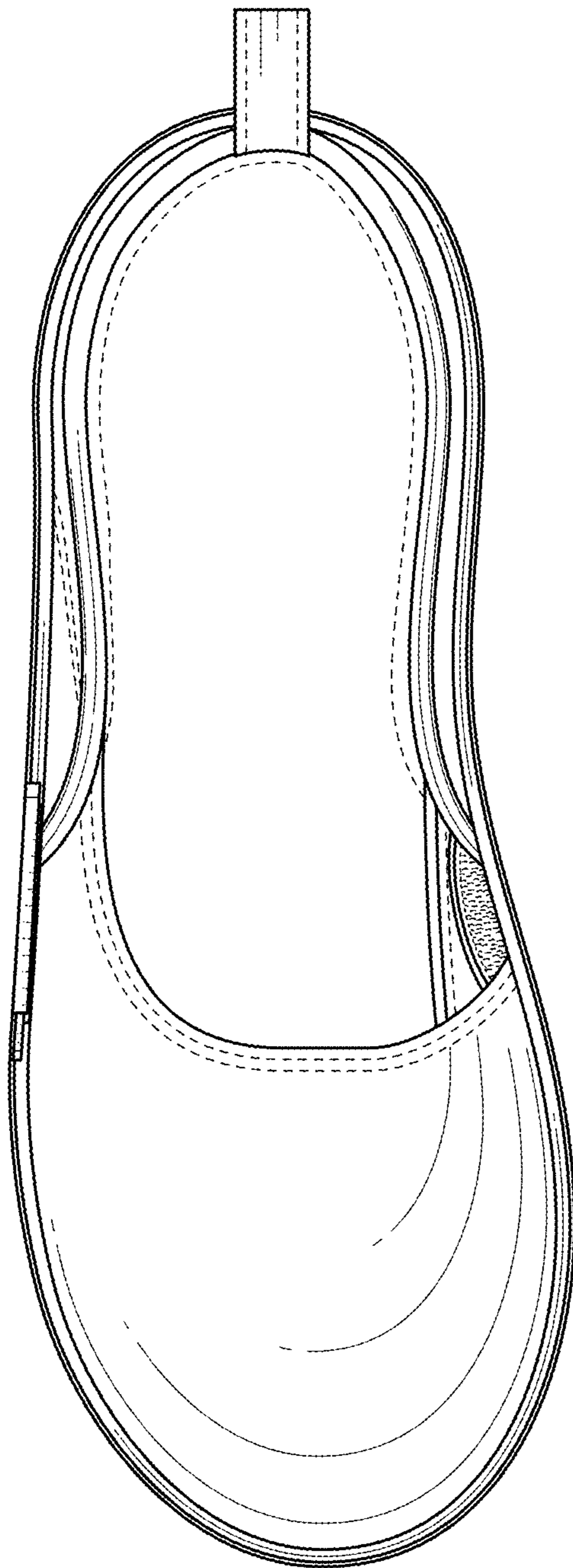

FIG. 20

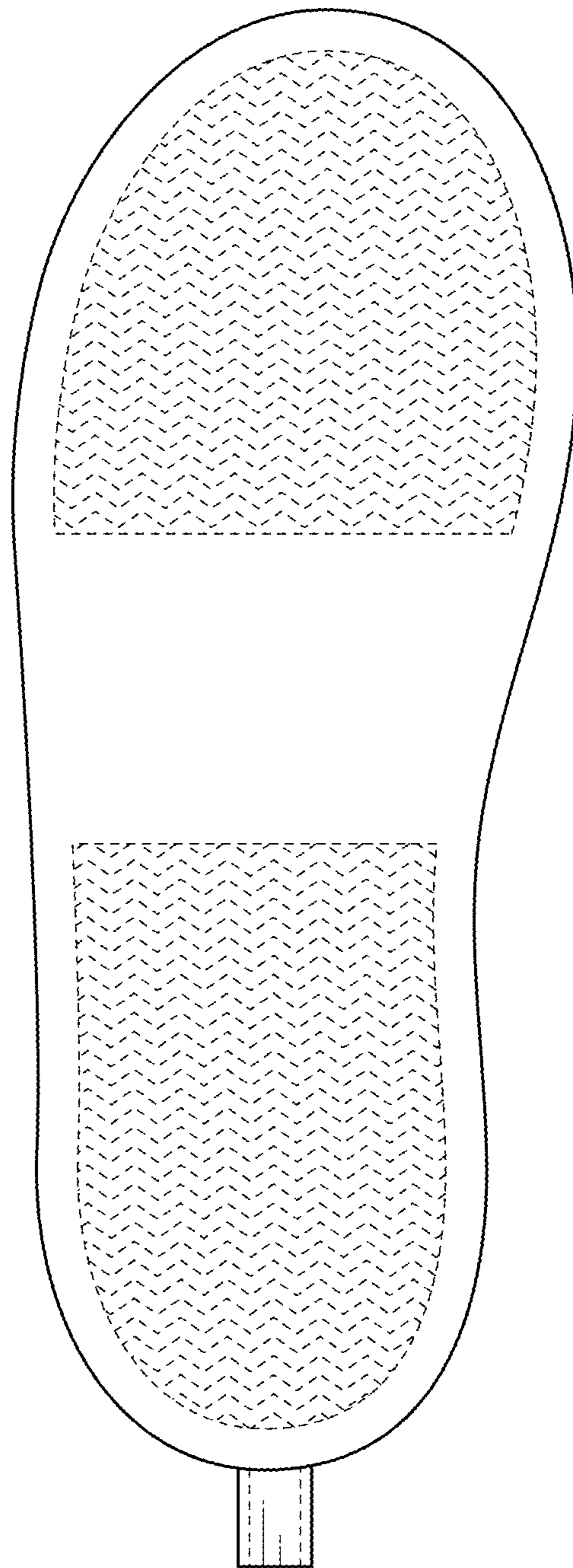

FIG. 21