



US00D872971S

(12) **United States Design Patent**  
**Caron et al.**

(10) **Patent No.:** **US D872,971 S**  
(45) **Date of Patent:** **\*\* Jan. 21, 2020**

(54) **LEGGINGS**

(71) Applicant: **Blanqi, LLC**, Atlanta, GA (US)

(72) Inventors: **Valerie Caron**, Fort Mill, SC (US);  
**Sabina Melarti**, Duluth, GA (US)

(73) Assignee: **Blanqi, LLC**, Atlanta, GA (US)

(\*\*) Term: **15 Years**

(21) Appl. No.: **29/656,262**

(22) Filed: **Jul. 11, 2018**

(51) **LOC (12) Cl.** ..... **02-02**

(52) **U.S. Cl.**  
USPC ..... **D2/742**

(58) **Field of Classification Search**  
USPC ..... D2/712, 716, 722, 728, 731-732, 738,  
D2/742, 744-745, 747-748  
See application file for complete search history.

(56) **References Cited**

**U.S. PATENT DOCUMENTS**

D343,496 S *	1/1994	Spoor	.....	D2/712
D586,085 S *	2/2009	Lounsbury, Jr.	.....	D2/742
D774,731 S	12/2016	Harris et al.		
D783,232 S *	4/2017	Zimmermann	.....	D2/731
2013/0019377 A1 *	1/2013	Lambertz	.....	A41D 13/0015 2/69
2018/0132544 A1 *	5/2018	Albanese	.....	A41D 13/0015
2018/0255854 A1 *	9/2018	Correia-Thomas	.....	A41D 31/0061

**OTHER PUBLICATIONS**

SportSupport Hipster Cuffed Leggings; BLANQI Website Earliest Review Sep. 2018; Visited Online Aug. 29, 2019; <https://www.blanqi.com/collections/support-bottoms/products/sport-support-hipster-cuffed-leggings?variant=12174620590188#shopify-product-reviews> (Year: 2018).\*

SportSupport Hipster Cuff Support Legging BLANQI; Visited Online Aug. 28, 2019; Nordstrom; <https://shop.nordstrom.com/s/blanqi-sport-support-hipster-cuff-support-maternity-postpartum-leggings> (Year: 2018).\*

BLANQI SportSupport HipsterCotour; Visited Online Aug. 28, 2019; [https://www.amazon.com/SportSupport-Hipster-Contour-Legging-Small/dp/B07DNKJMC/ref=pd\\_sbs\\_193\\_2/134-9661369-6654345?](https://www.amazon.com/SportSupport-Hipster-Contour-Legging-Small/dp/B07DNKJMC/ref=pd_sbs_193_2/134-9661369-6654345?) (Year: 2018).\*

(Continued)

*Primary Examiner* — Amy C Wierenga

(74) *Attorney, Agent, or Firm* — Lerner, David, Littenberg, Krumholz & Mentlik, LLP

(57) **CLAIM**

The ornamental design for leggings, as shown and described.

**DESCRIPTION**

This application is related to U.S. application Ser. No. 29/656,241, filed Jul. 11, 2018, entitled “Leggings,” and, U.S. application Ser. No. 29/656,275 filed Jul. 11, 2018, entitled “Leggings,” both of which are concurrently filed herewith, and the disclosures all of which are incorporated herein by reference.

FIG. 1 is a front perspective view of leggings according to our new design;

FIG. 2 is a rear perspective view thereof;

FIG. 3 is a front elevation view thereof;

FIG. 4 is a rear elevation view thereof;

FIG. 5 is a right side elevation view thereof, the left side being a mirror image thereof;

FIG. 6 is an enlarged view of the corresponding section shown in FIG. 1; and,

FIG. 7 is an enlarged view of the corresponding section shown in FIG. 1.

The broken lines shown in the drawings are for the purpose of illustrating portions of the leggings that form no part of the claimed design.

**1 Claim, 7 Drawing Sheets**

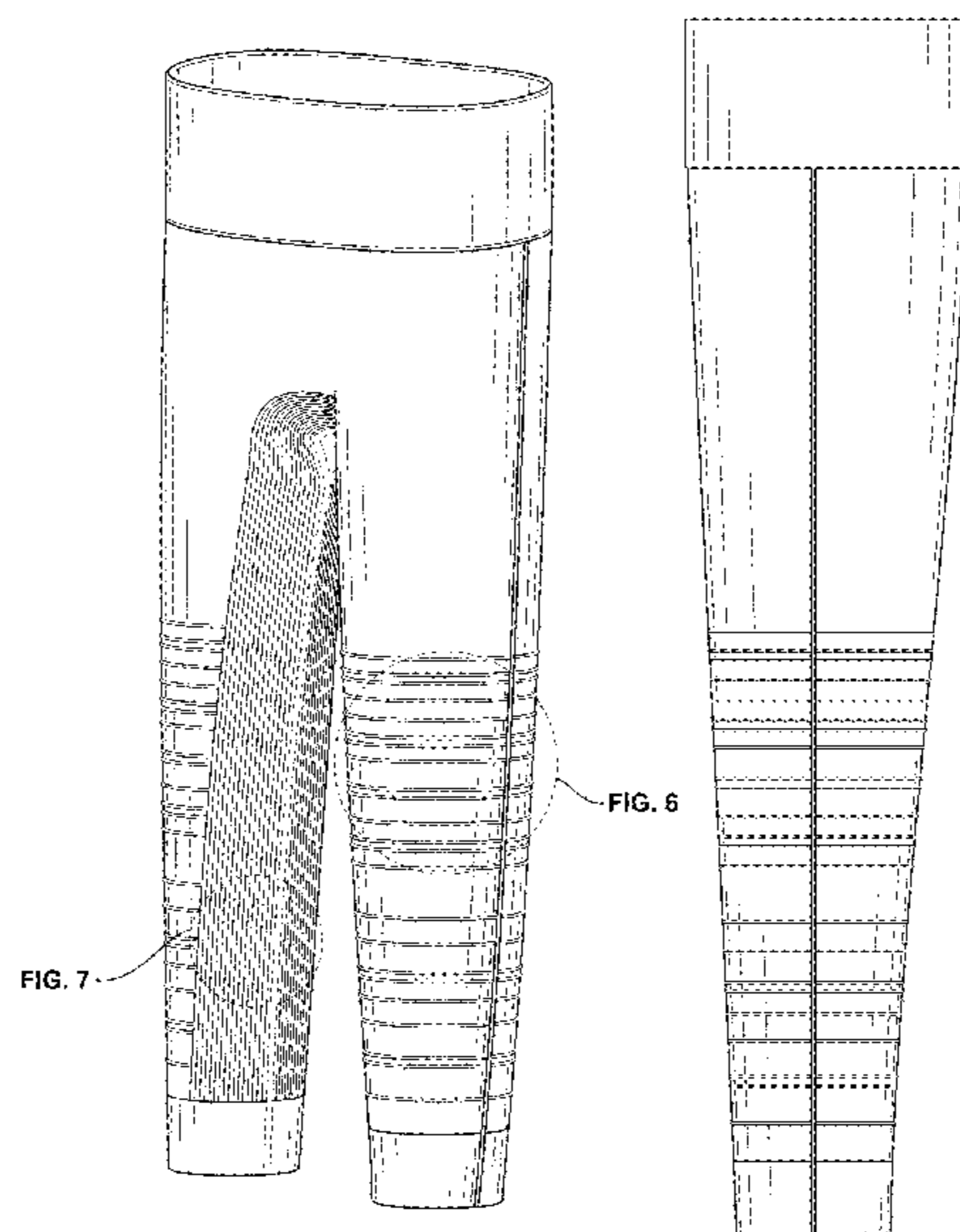

(56)

**References Cited**

OTHER PUBLICATIONS

Caron et al., U.S. Appl. No. 29/656,236, filed Jul. 11, 2018, titled "Leggings".  
Caron et al., U.S. Appl. No. 29/656,241, filed Jul. 11, 2018, titled "Leggings".  
Caron et al., U.S. Appl. No. 29/656,275, filed Jul. 11, 2018, titled "Leggings".  
Caron et al., U.S. Appl. No. 29/656,285, filed Jul. 11, 2018, titled "Leggings".  
Caron et al., U.S. Appl. No. 29/656,295, filed Jul. 11, 2018, titled "Leggings".  
Caron et al., U.S. Appl. No. 29/656,297, filed Jul. 11, 2018, titled "Leggings".

\* cited by examiner

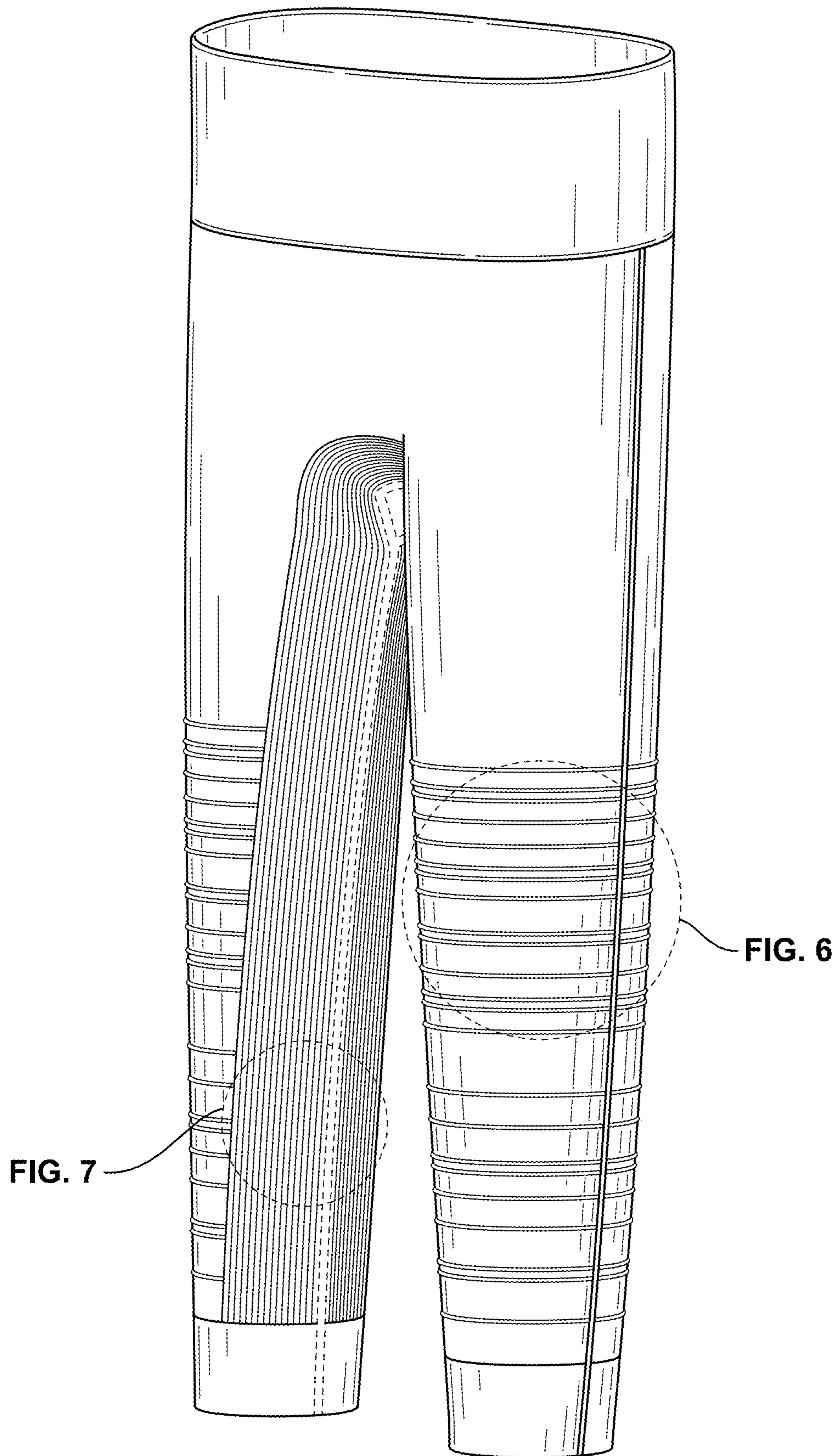

FIG. 1

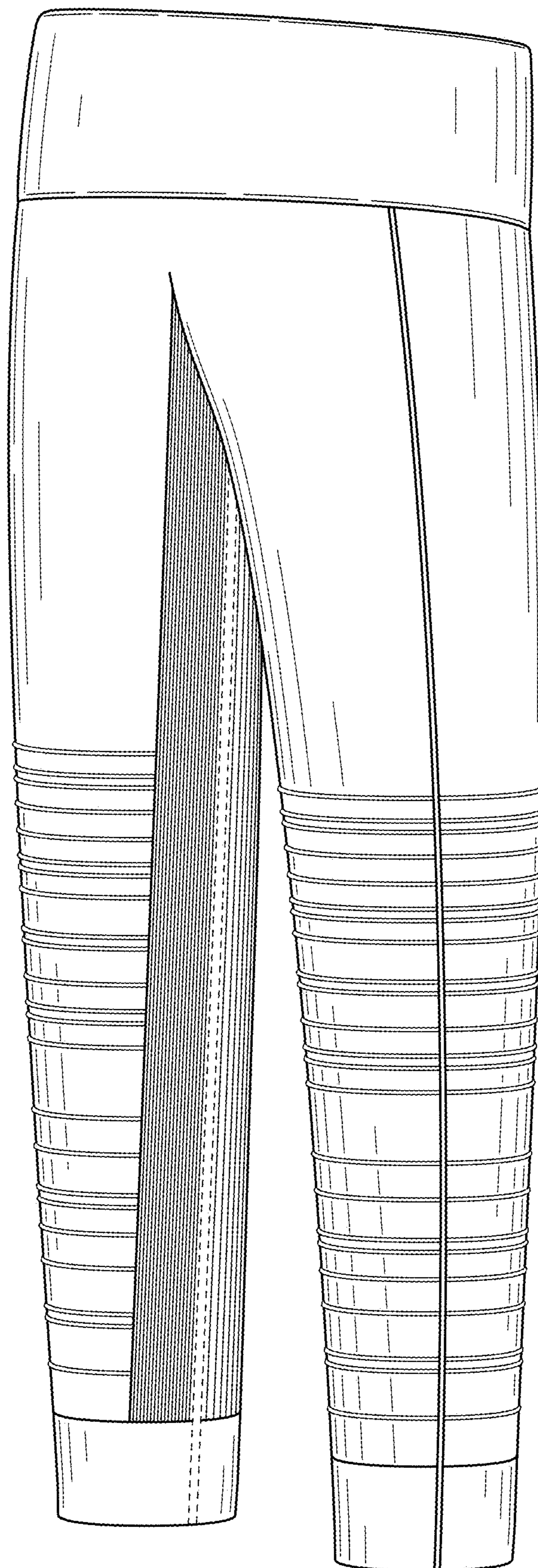

FIG. 2

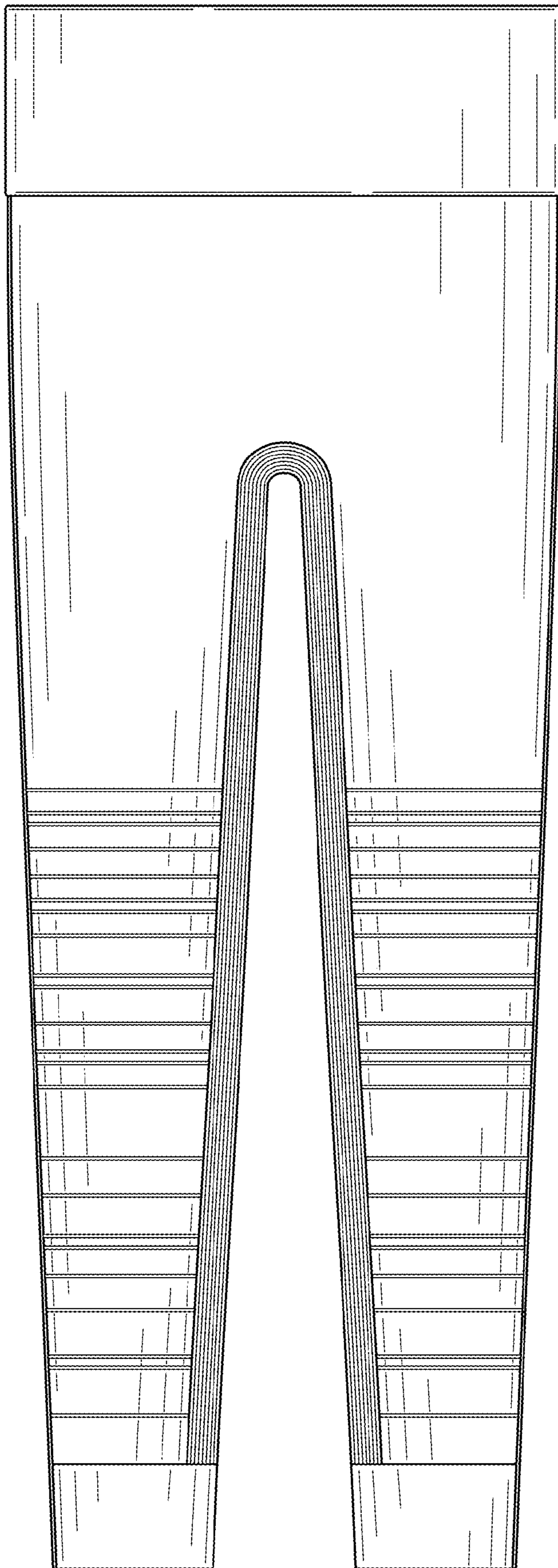

FIG. 3

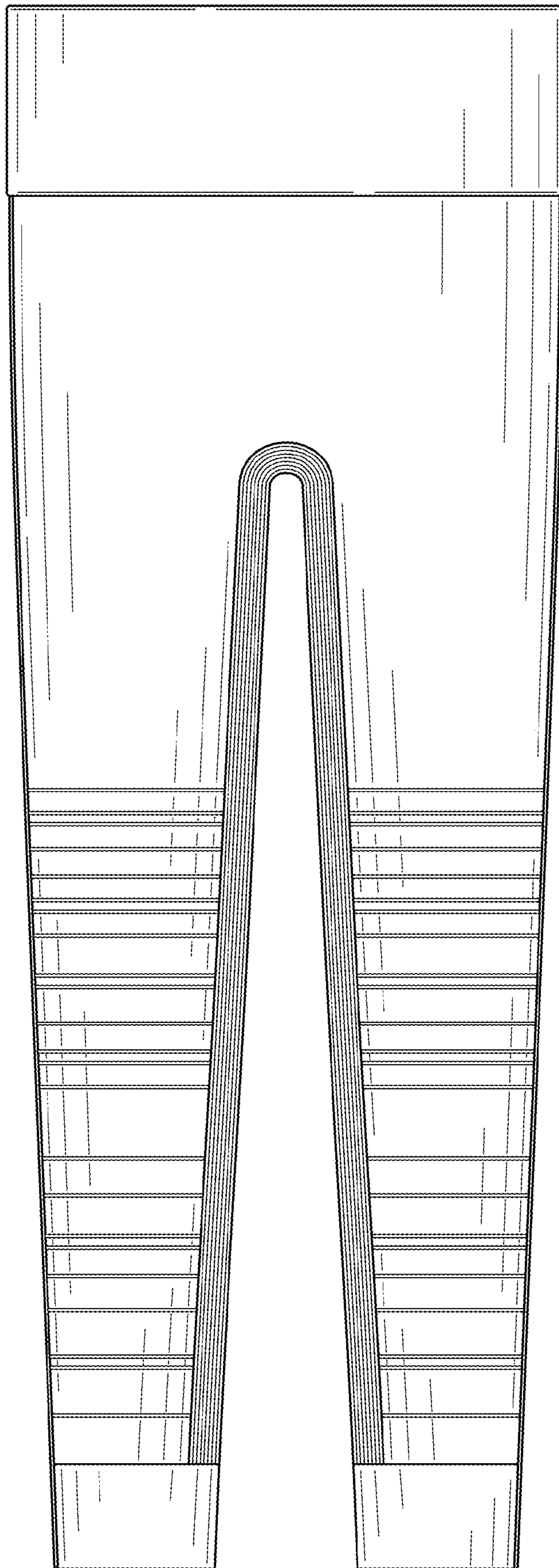

FIG. 4

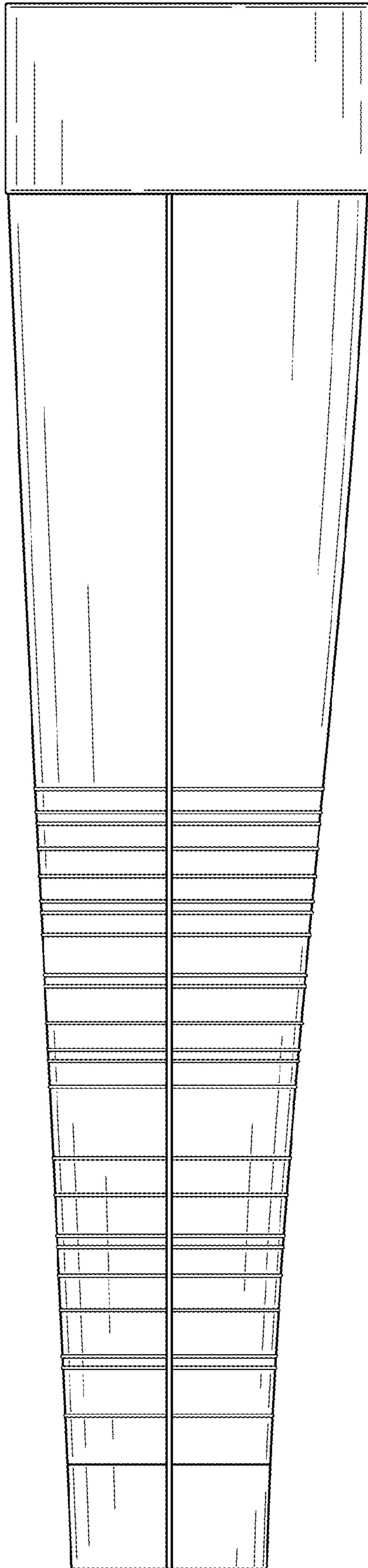

FIG. 5

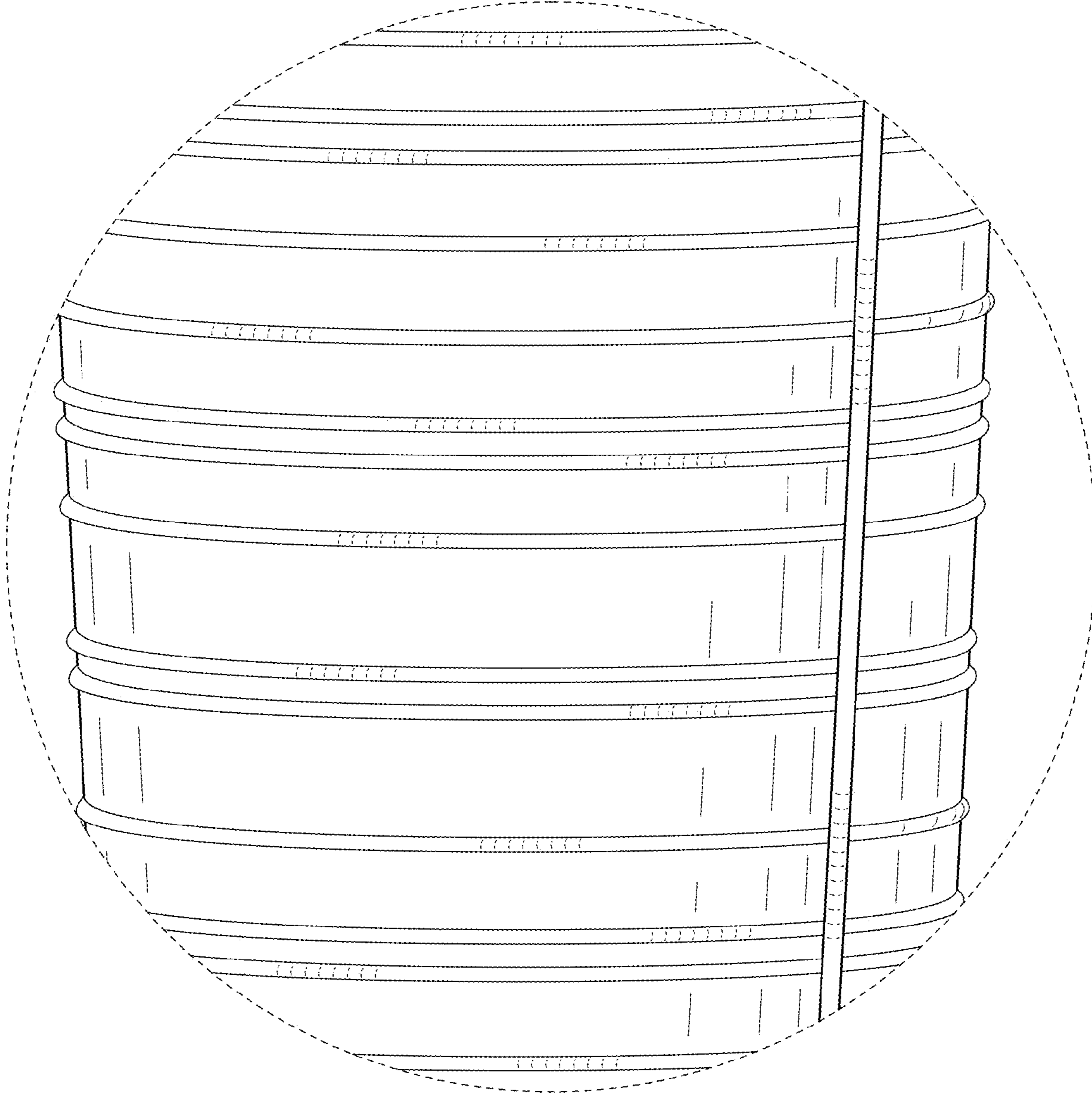

FIG. 6



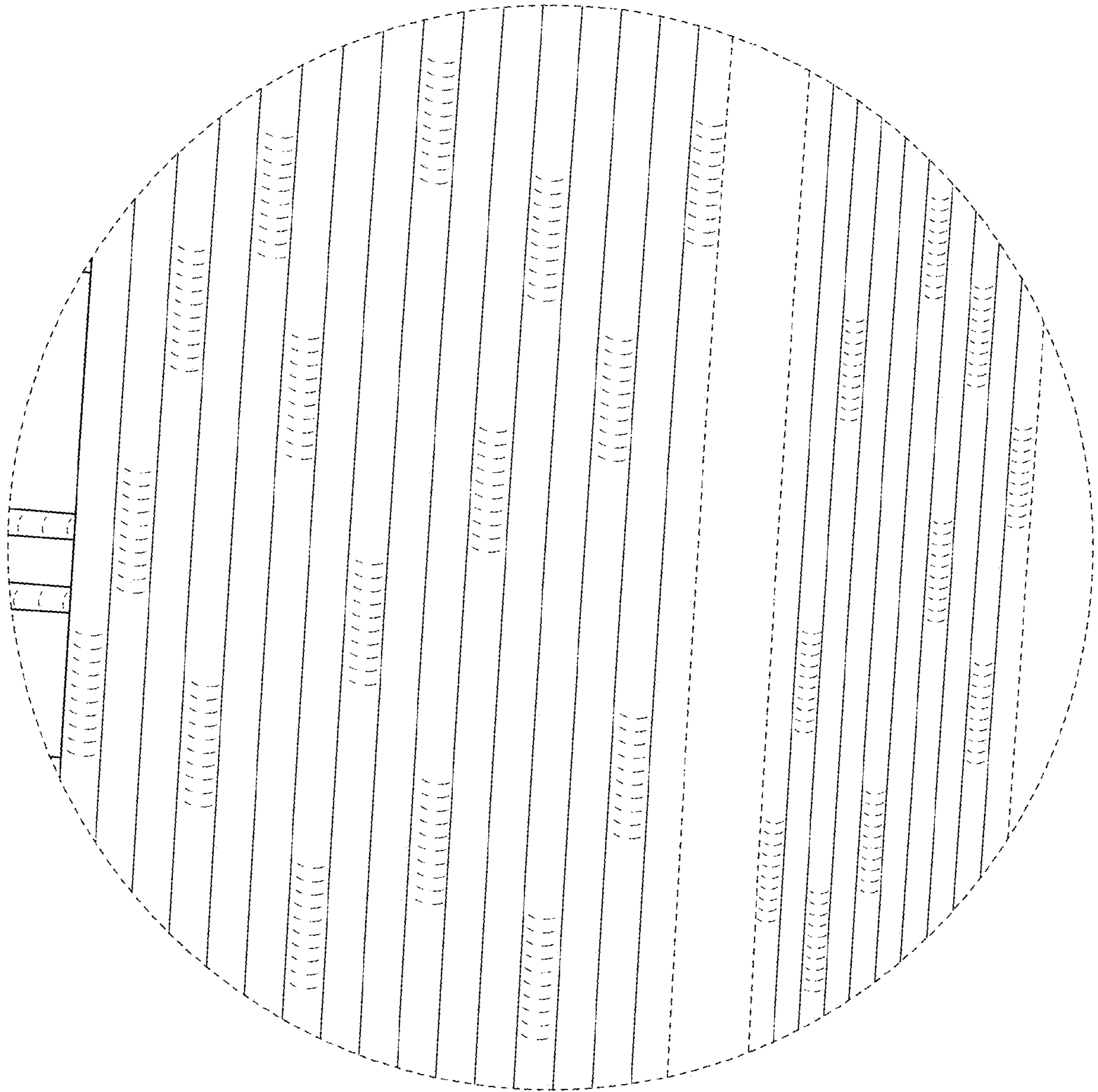

FIG. 7