



US00D872937S

(12) **United States Design Patent** (10) **Patent No.:** **US D872,937 S**
Kottidi et al. (45) **Date of Patent:** **** Jan. 14, 2020**

- (54) **COMBINED SHAVING CARTRIDGE AND LUBRICATING ELEMENTS**
 - (71) Applicant: **Societe BIC**, Clichy (FR)
 - (72) Inventors: **Triantafyllia Kottidi**, Athens (GR);
Maria Petratos, Athens (GR)
 - (73) Assignee: **Societe BIC**, Clichy (FR)
 - (**) Term: **15 Years**
 - (21) Appl. No.: **29/643,297**
 - (22) Filed: **Apr. 6, 2018**
 - (51) **LOC (12) Cl.** **28-03**
 - (52) **U.S. Cl.**
USPC **D28/47**
 - (58) **Field of Classification Search**
USPC D28/45-48
- (Continued)

- (56) **References Cited**
U.S. PATENT DOCUMENTS
 - 6,161,287 A * 12/2000 Swanson B26B 21/225
30/50
 - D542,972 S * 5/2007 Pryor D28/47
- (Continued)

Primary Examiner — Jennifer Rivard
(74) *Attorney, Agent, or Firm* — The H.T. Than Law Group

(57) **CLAIM**
The ornamental design for a combined shaving cartridge and lubricating elements, as shown and described.

DESCRIPTION

The patent or application file contains at least one drawing executed in color. Copies of this patent or patent application publication with color drawing(s) will be provided by the Office upon request and payment of the necessary fee.

FIG. 1 is perspective view of an ornamental design for a combined shaving cartridge and lubricating elements according to the present invention;
 FIG. 2 is a front view thereof;
 FIG. 3 is a back view thereof;
 FIG. 4 is a left side view thereof;
 FIG. 5 is a right side view thereof;
 FIG. 6 is a top view thereof;
 FIG. 7 is a bottom view thereof;
 FIG. 8 is perspective view of an ornamental design for the second embodiment for a combined shaving cartridge and lubricating elements according to the present invention;
 FIG. 9 is a front view thereof;
 FIG. 10 is a back view thereof;
 FIG. 11 is a left side view thereof;
 FIG. 12 is a right side view thereof;
 FIG. 13 is a top view thereof;
 FIG. 14 is a bottom view thereof;
 FIG. 15 is perspective view of an ornamental design for the third embodiment for a combined shaving cartridge and lubricating elements according to the present invention;
 FIG. 16 is a front view thereof;
 FIG. 17 is a back view thereof;
 FIG. 18 is a left side view thereof;
 FIG. 19 is a right side view thereof;
 FIG. 20 is a top view thereof;
 FIG. 21 is a bottom view thereof;
 FIG. 22 is perspective view of an ornamental design for the fourth embodiment for a combined shaving cartridge and lubricating elements according to the present invention;
 FIG. 23 is a front view thereof;
 FIG. 24 is a back view thereof;
 FIG. 25 is a left side view thereof;
 FIG. 26 is a right side view thereof;
 FIG. 27 is a top view thereof;
 FIG. 28 is a bottom view thereof;
 FIG. 29 is perspective view of an ornamental design for the fifth embodiment for a combined shaving cartridge and lubricating elements according to the present invention;
 FIG. 30 is a front view thereof;
 FIG. 31 is a back view thereof;
 FIG. 32 is a left side view thereof;
 FIG. 33 is a right side view thereof;
 FIG. 34 is a top view thereof; and,

(Continued)

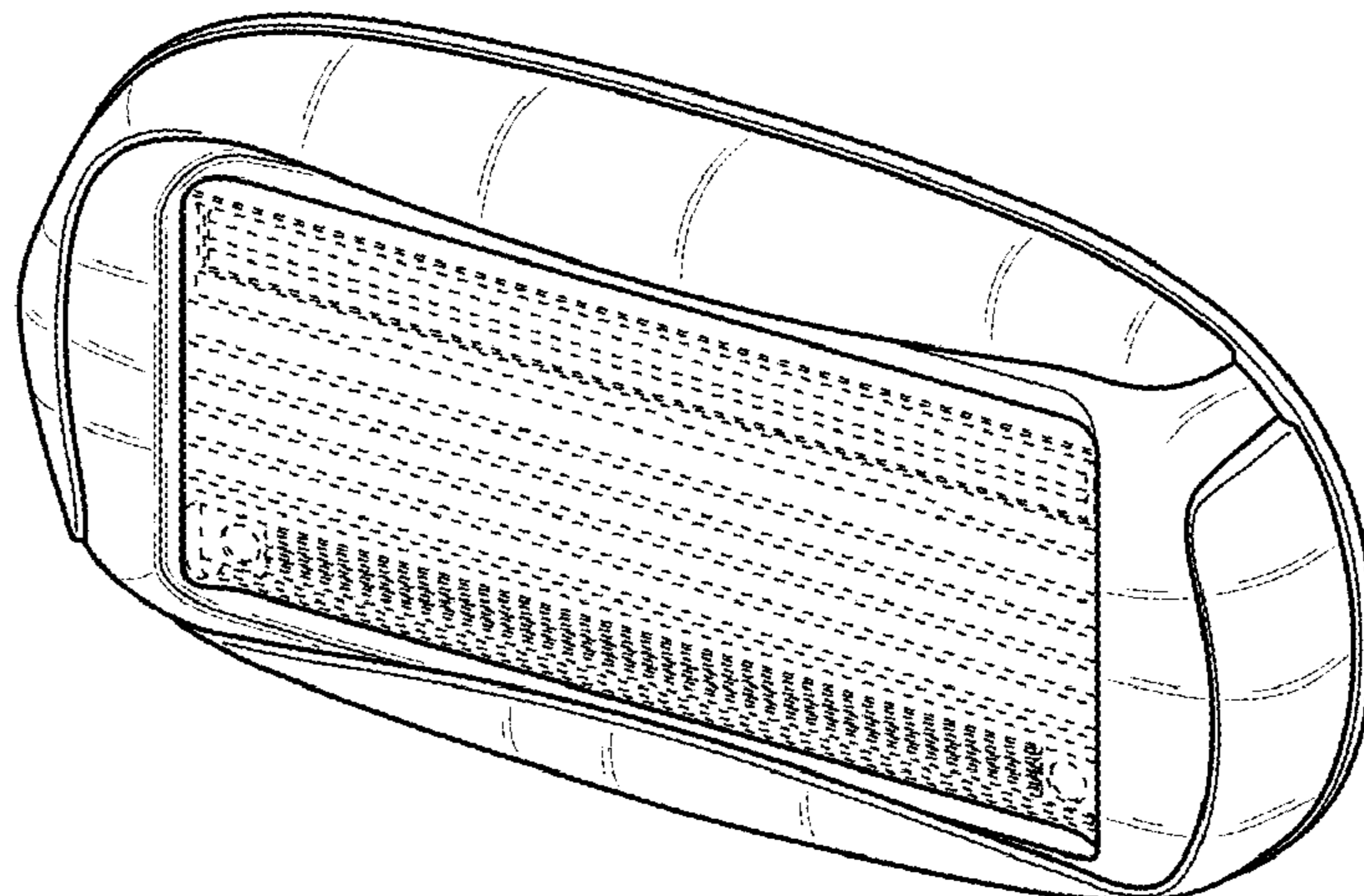

FIG. 35 is a bottom view thereof.

The broken lines illustrate portions of the shaving cartridge with lubricating elements and form no part of the claimed design.

In FIGS. 8-14, the lubricating elements are blue and pink. In FIGS. 15-21, the lubricating elements are pink. In FIGS. 22-35, the lighter and darker levels of stippling illustrate two different colors.

**1 Claim, 20 Drawing Sheets
(8 of 20 Drawing Sheet(s) Filed in Color)**

(58) Field of Classification Search

CPC B26B 21/00-06; B26B 21/08-227; B26B
21/24-28; B26B 21/30-38; B26B
21/40-4093; B26B 21/52-528

See application file for complete search history.

(56)

References Cited

U.S. PATENT DOCUMENTS

D547,494	S	*	7/2007	Watson	D28/47
D550,400	S	*	9/2007	Orloff	D28/47
D627,518	S	*	11/2010	Kinard	D28/47
D630,378	S	*	1/2011	Jung	D28/47
D631,198	S	*	1/2011	Adams	D28/47
D634,474	S		3/2011	Wilby		
D638,580	S	*	5/2011	Adams	D28/46
D653,395	S	*	1/2012	Adams	D28/47
D662,661	S	*	6/2012	Corbeil	D28/47
D698,998	S	*	2/2014	Lukan	D28/46
D748,856	S	*	2/2016	Mahony	D28/47
D772,484	S	*	11/2016	Otsuka	D28/47
D778,498	S	*	2/2017	Petratou	D28/47
D819,273	S	*	5/2018	Cabrera	D28/47
D829,380	S	*	9/2018	Kong	D28/47
D837,452	S	*	1/2019	Goeder	D28/47

* cited by examiner

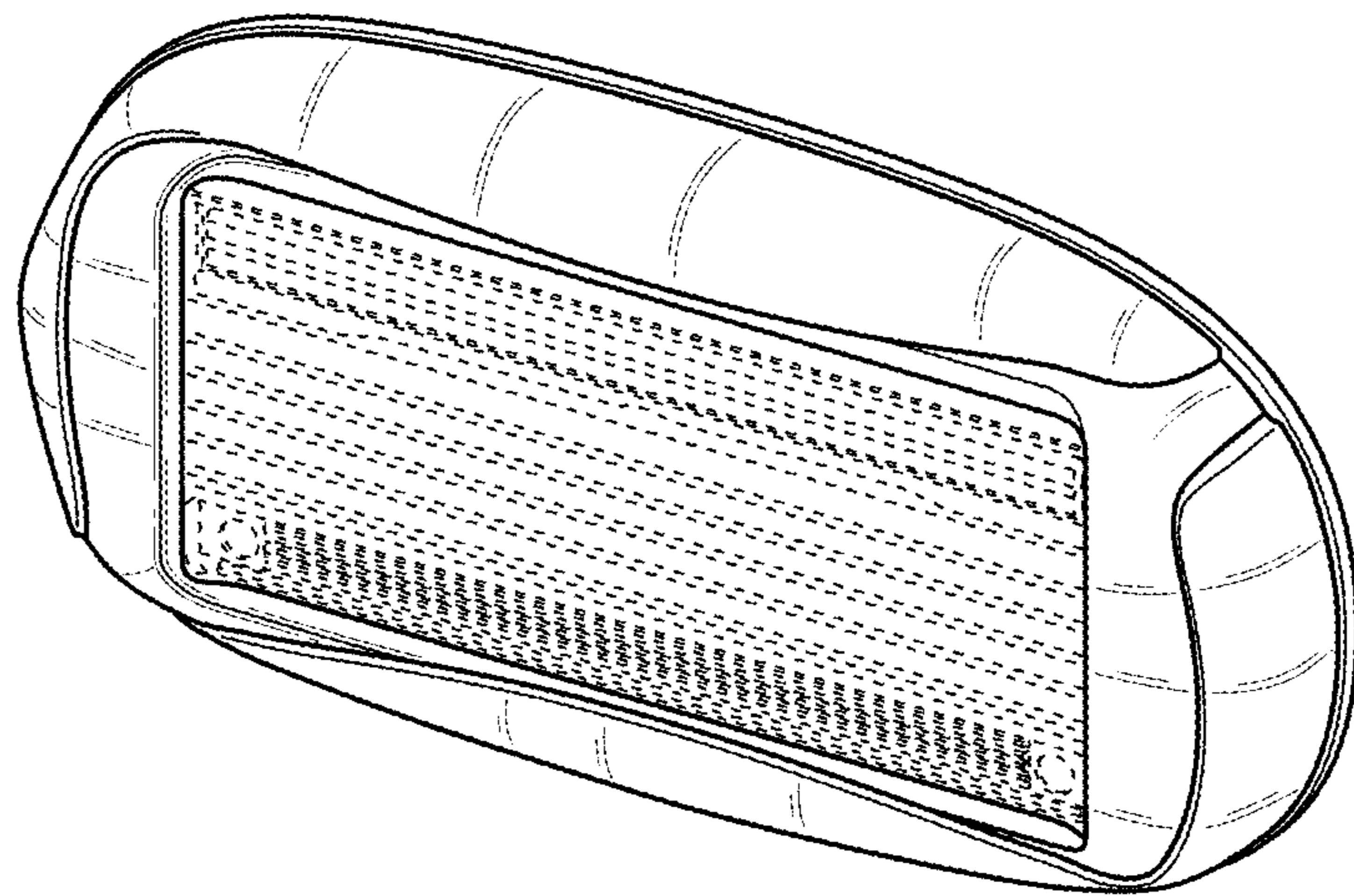

Fig. 1

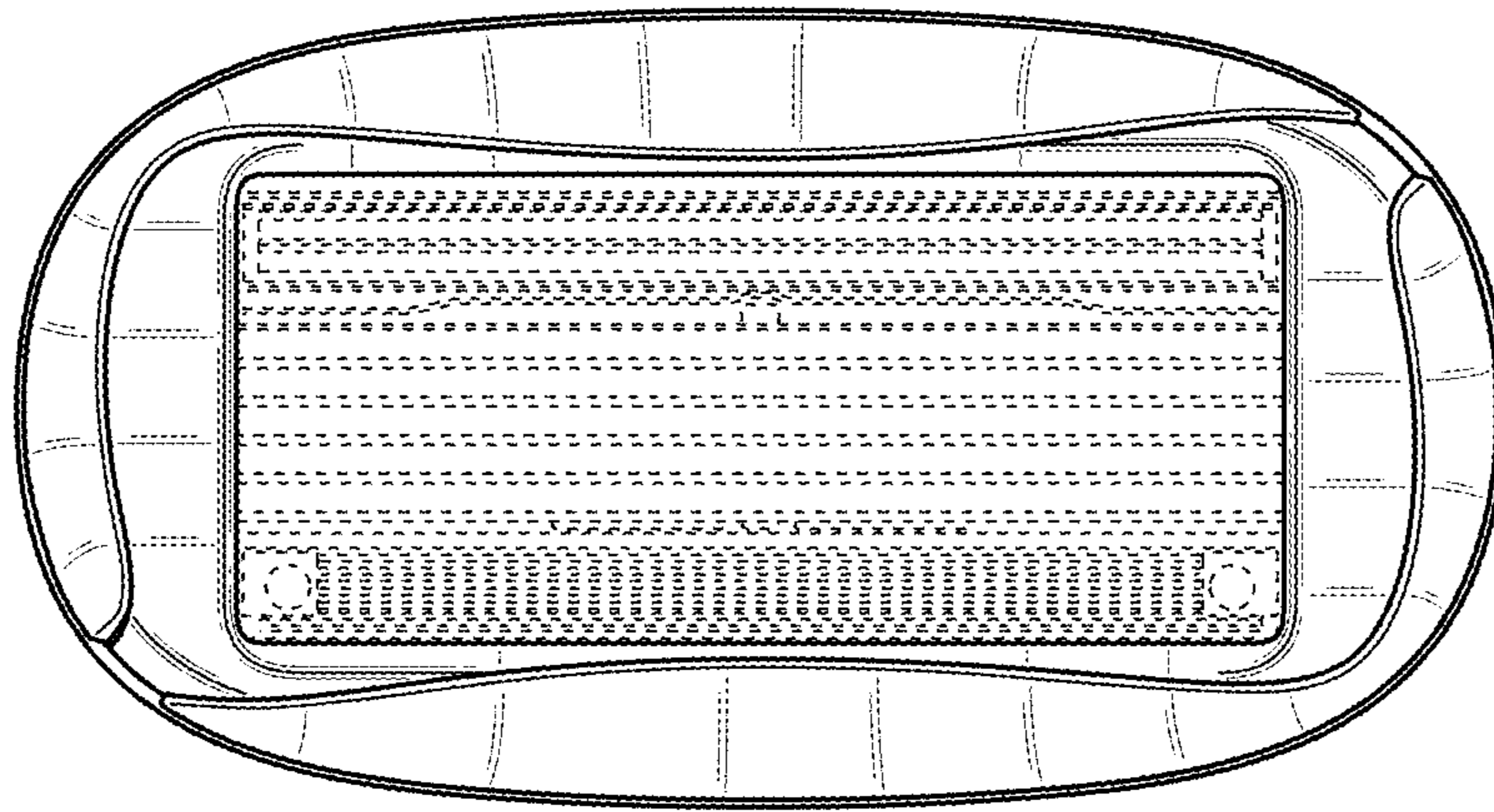

Fig. 2

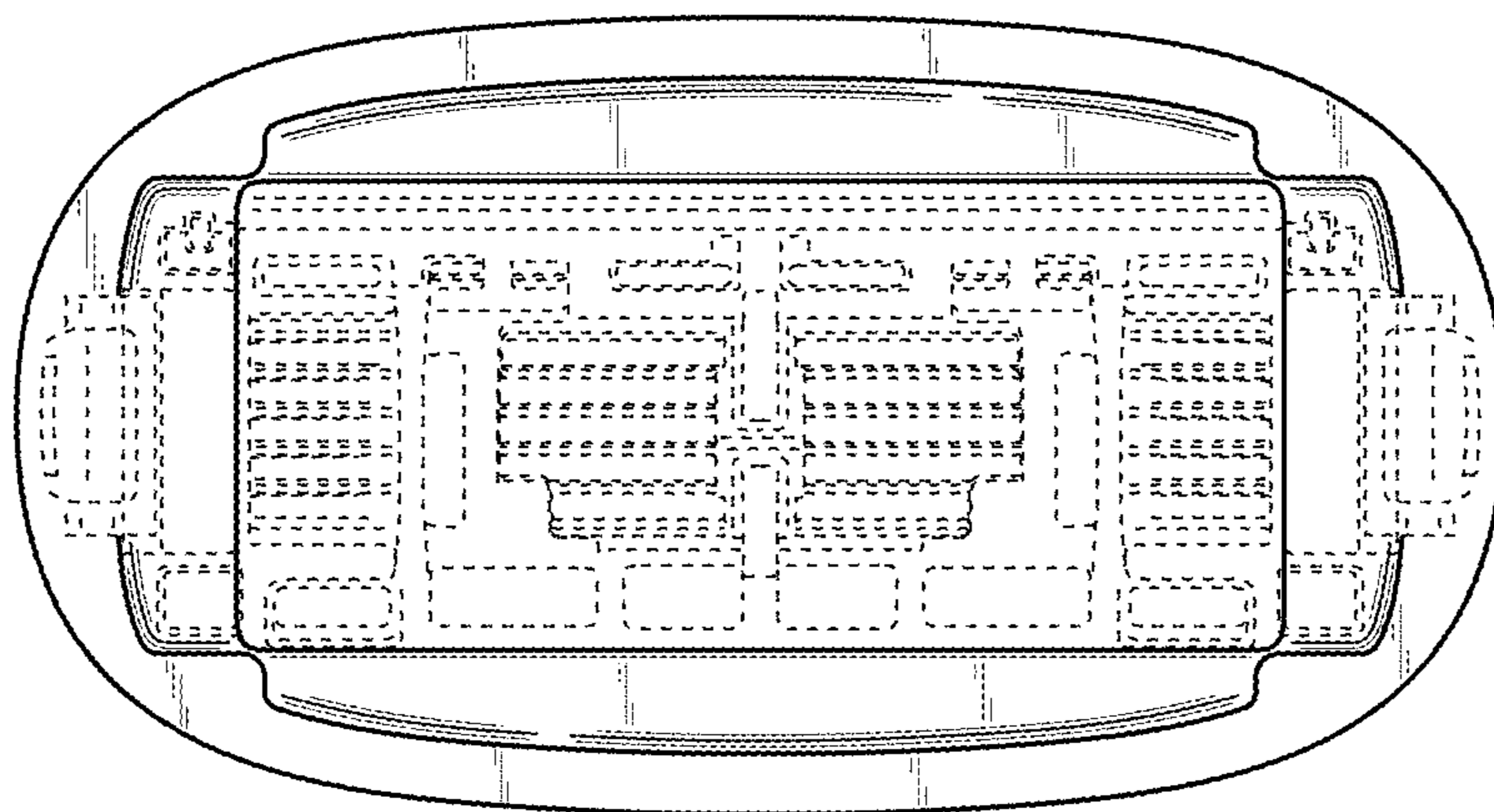

Fig. 3

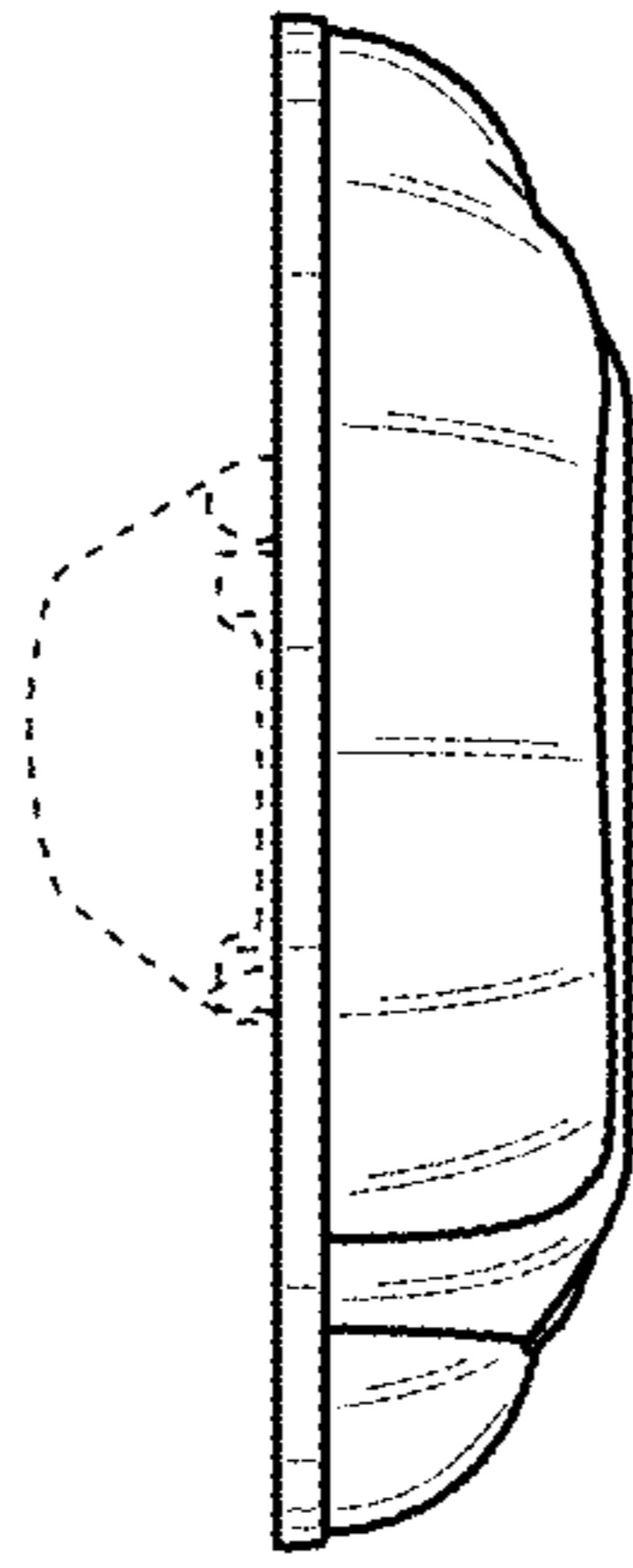

Fig. 4

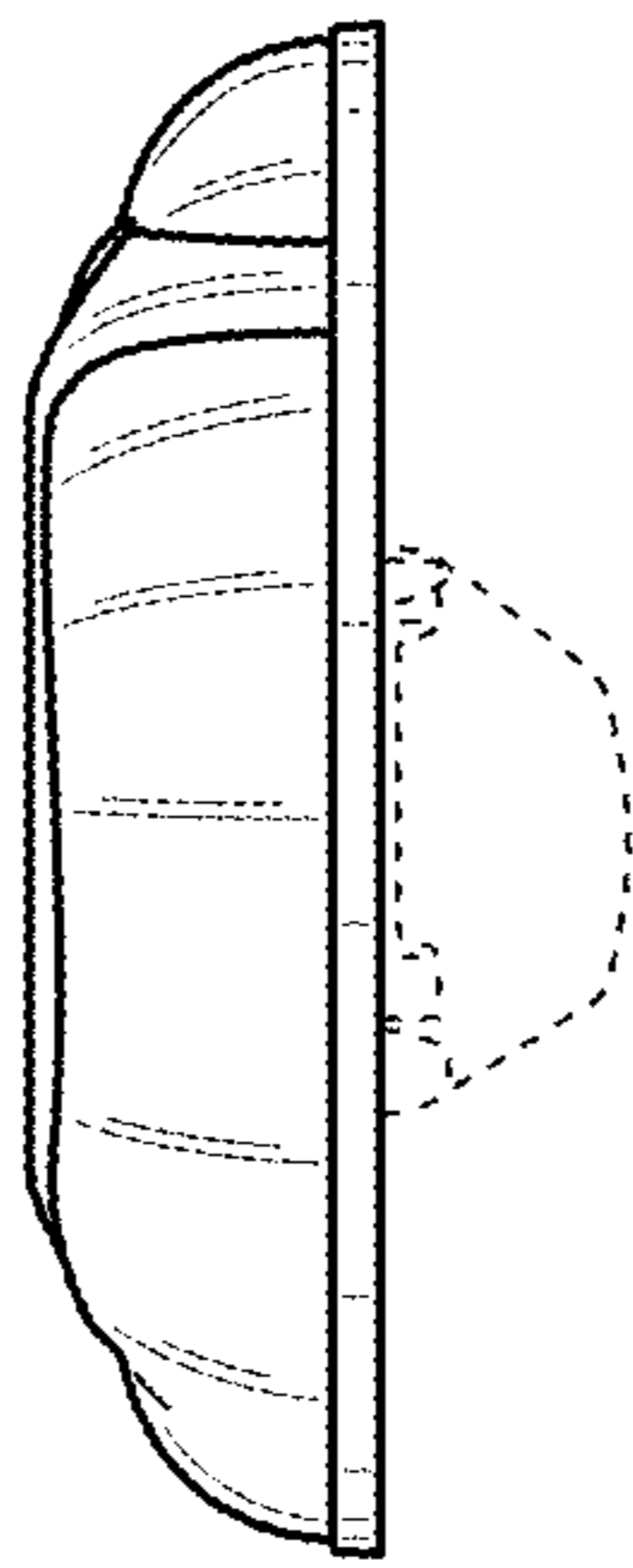

Fig. 5

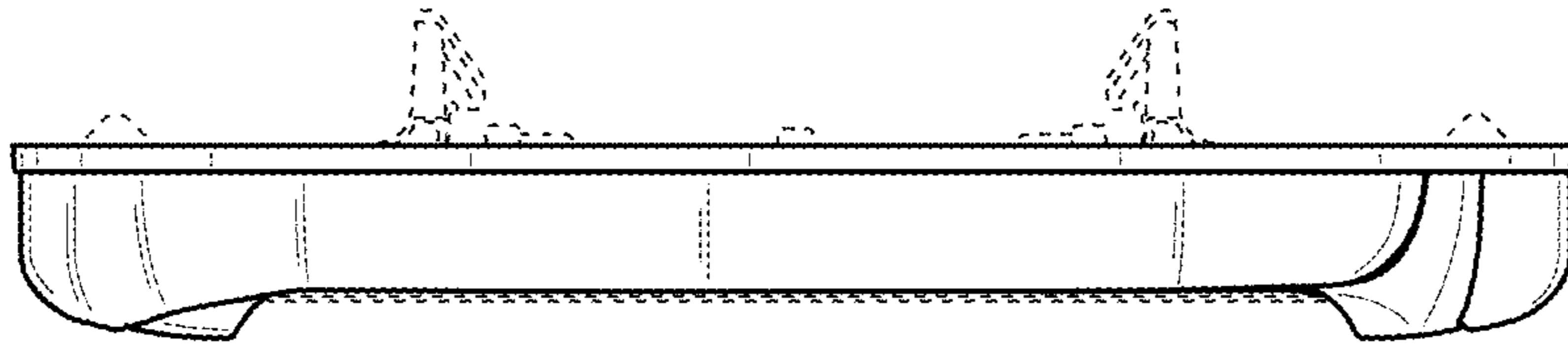

Fig. 6

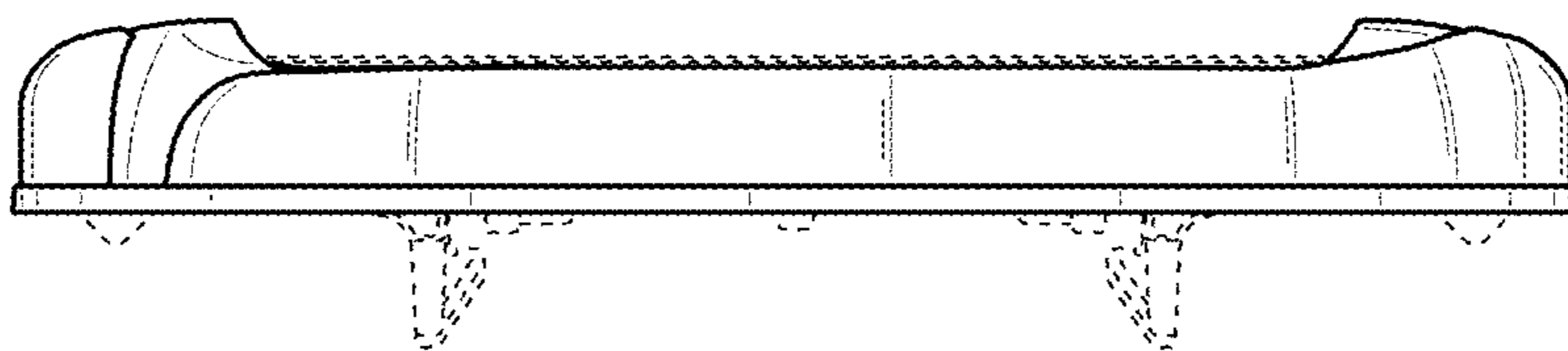

Fig. 7

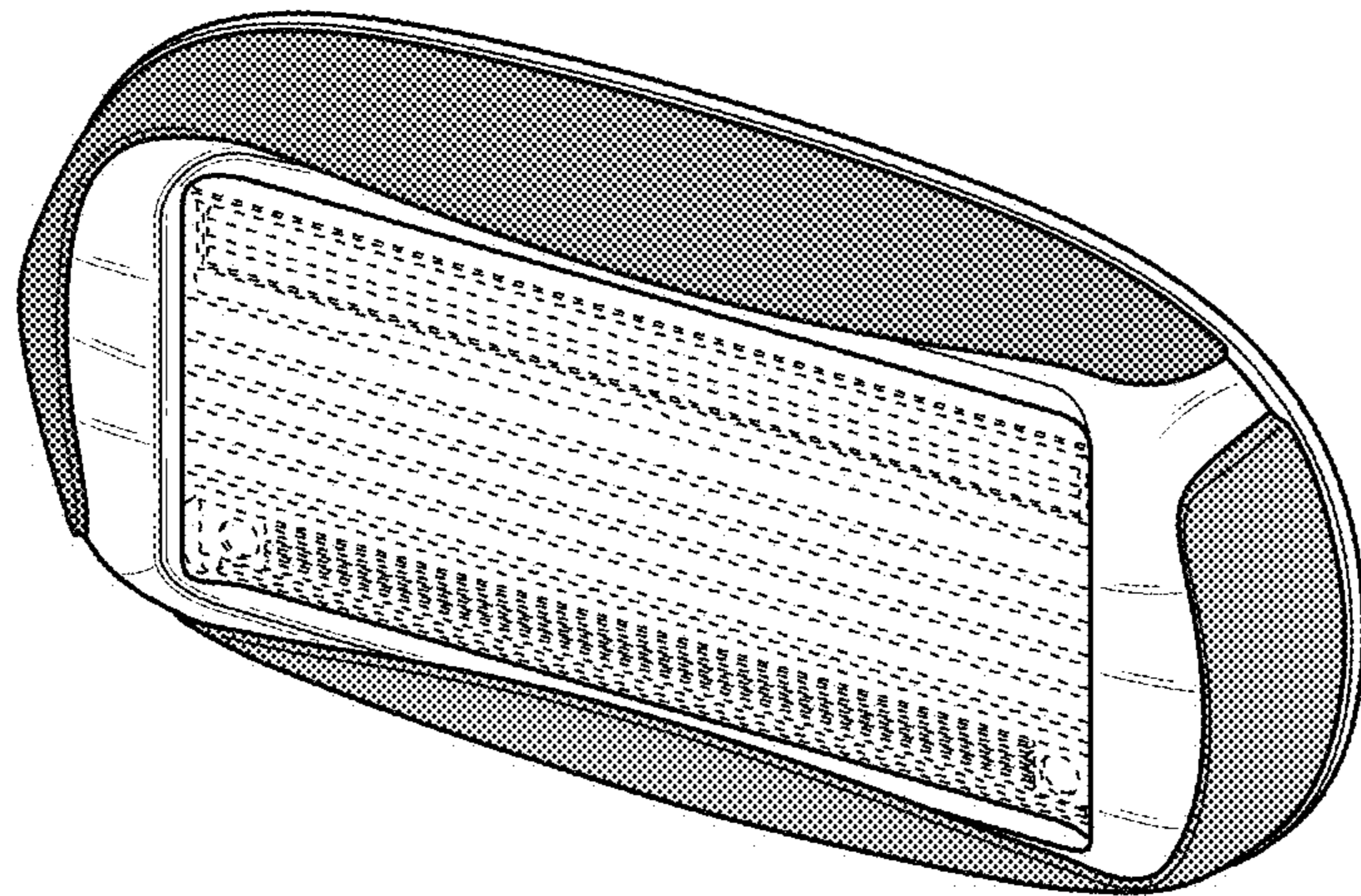

Fig. 8

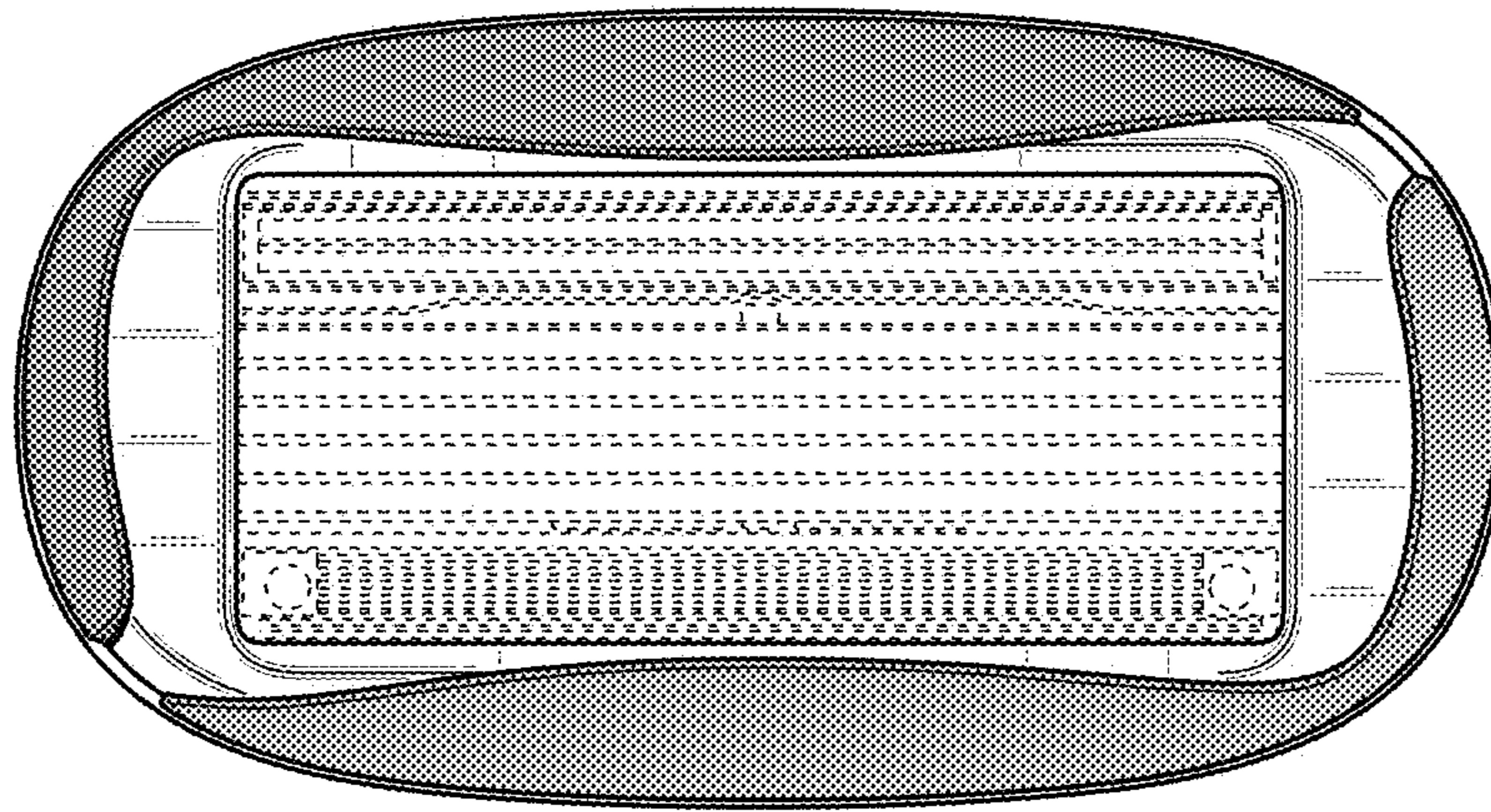

Fig. 9

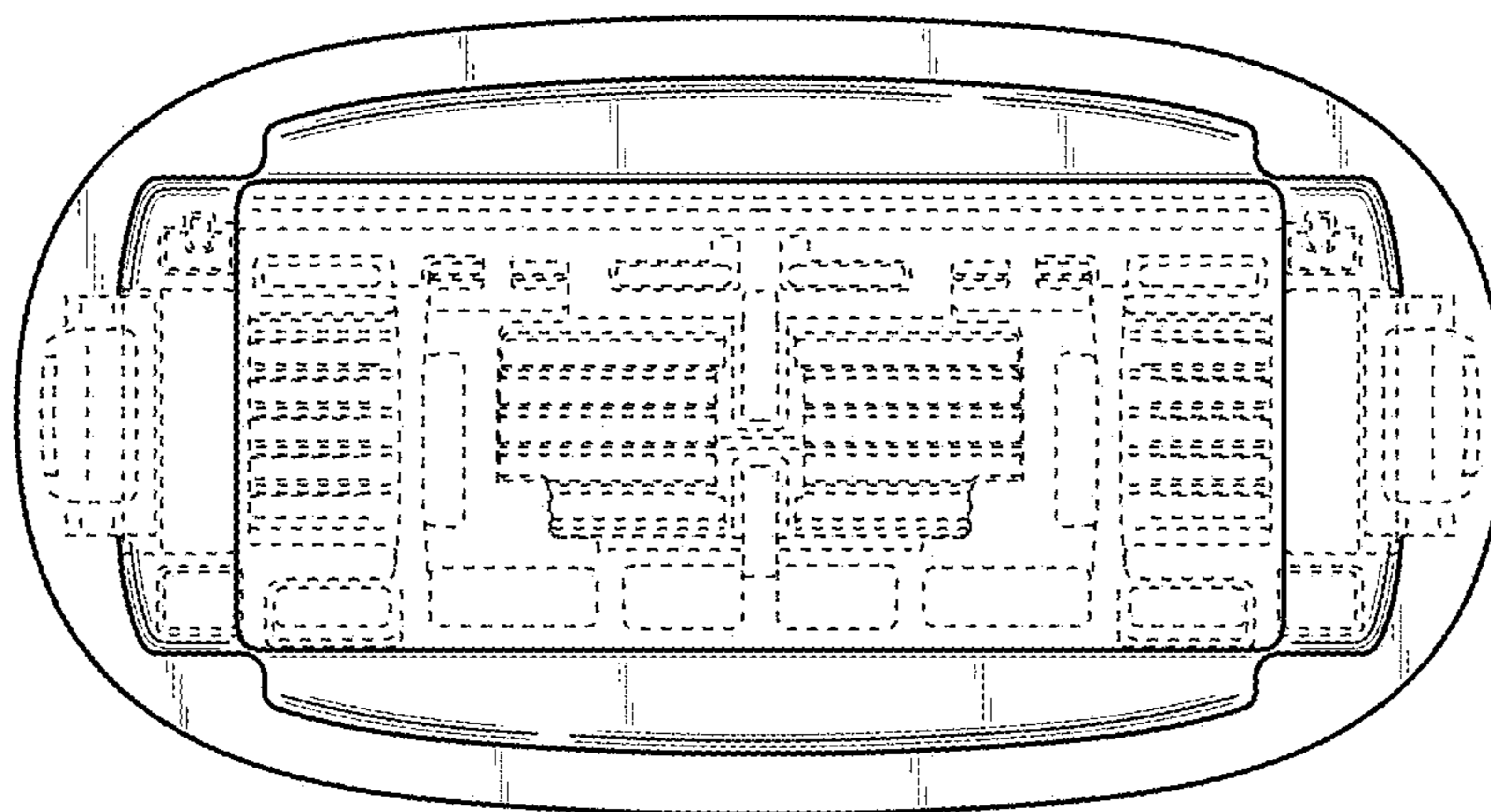

Fig. 10

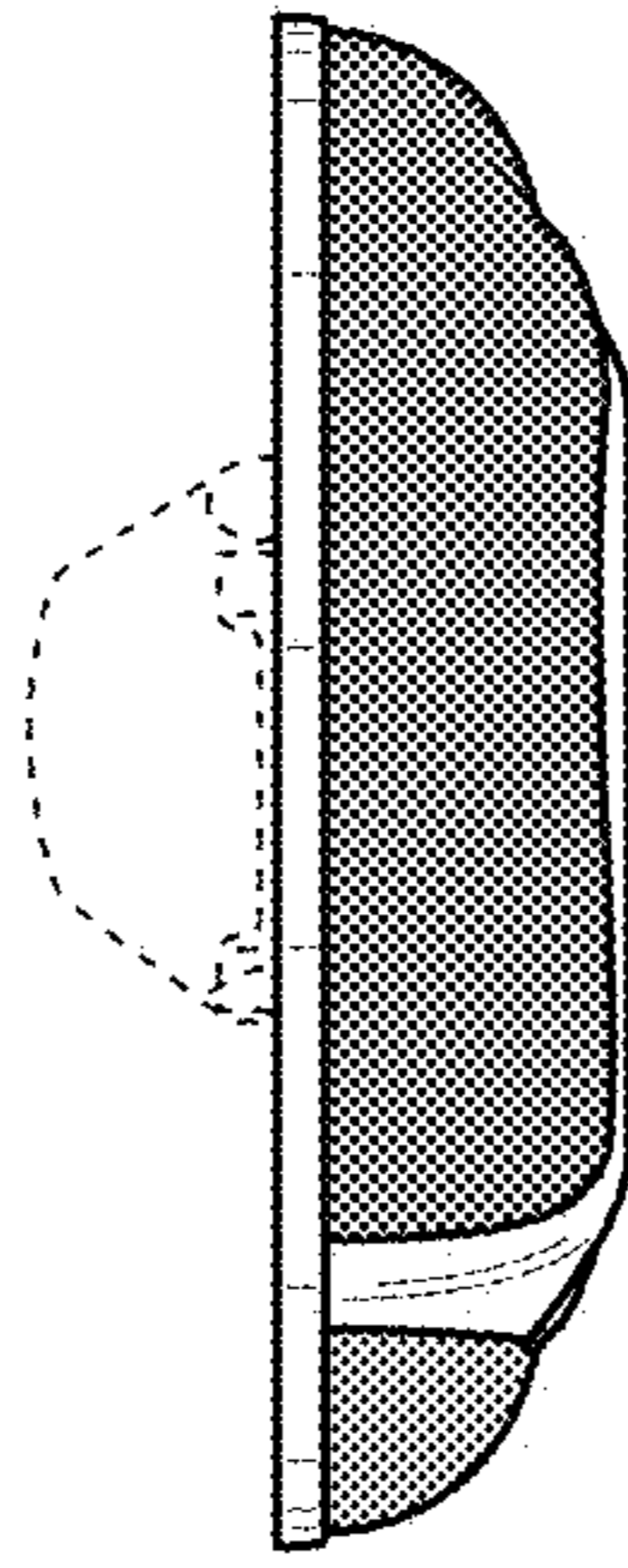

Fig. 11

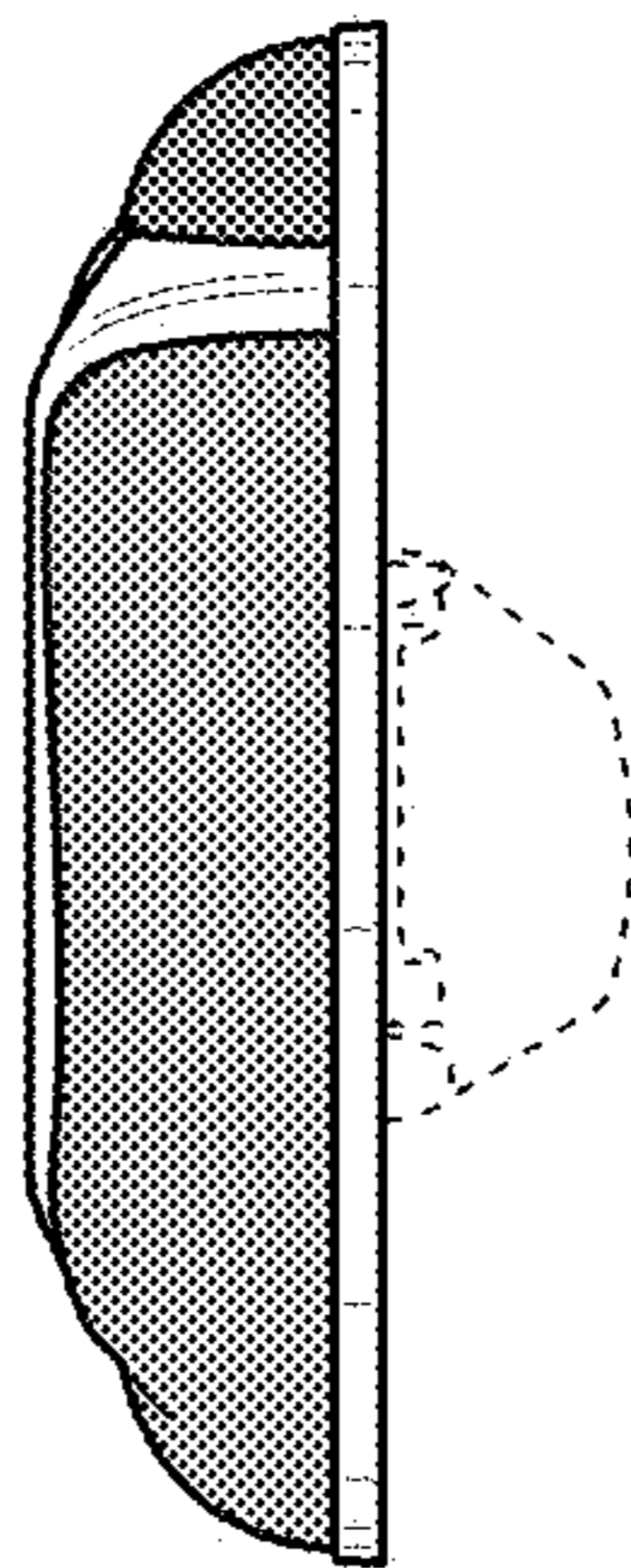

Fig. 12

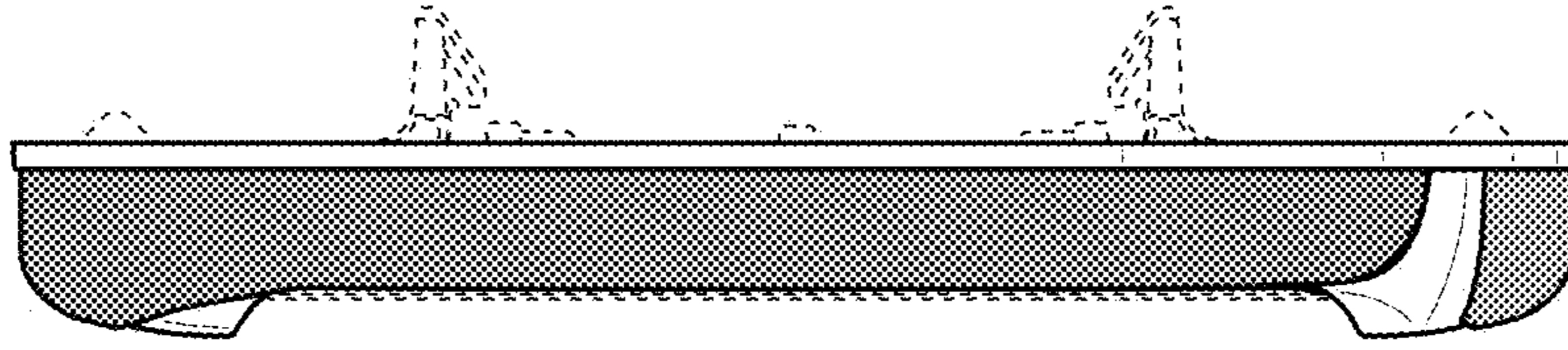

Fig. 13

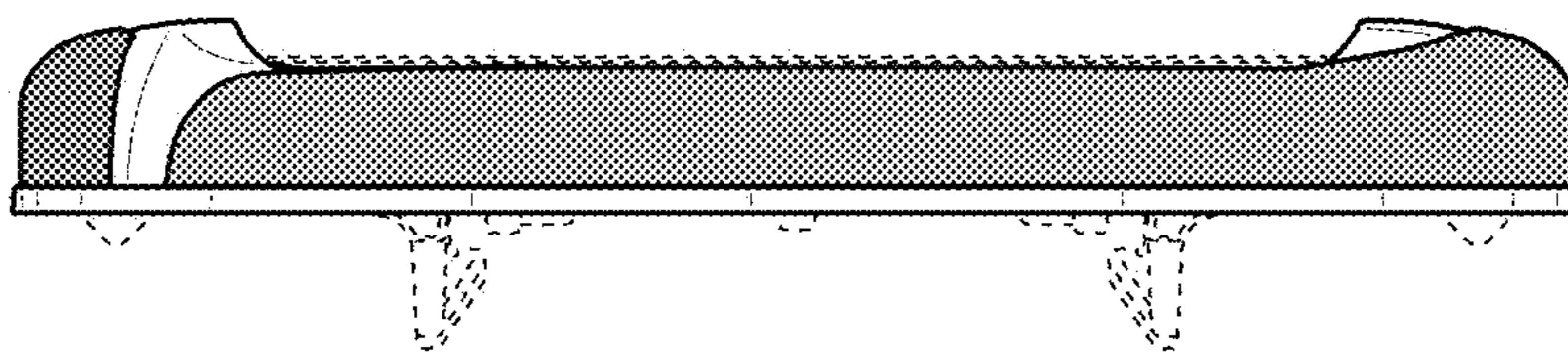

Fig. 14

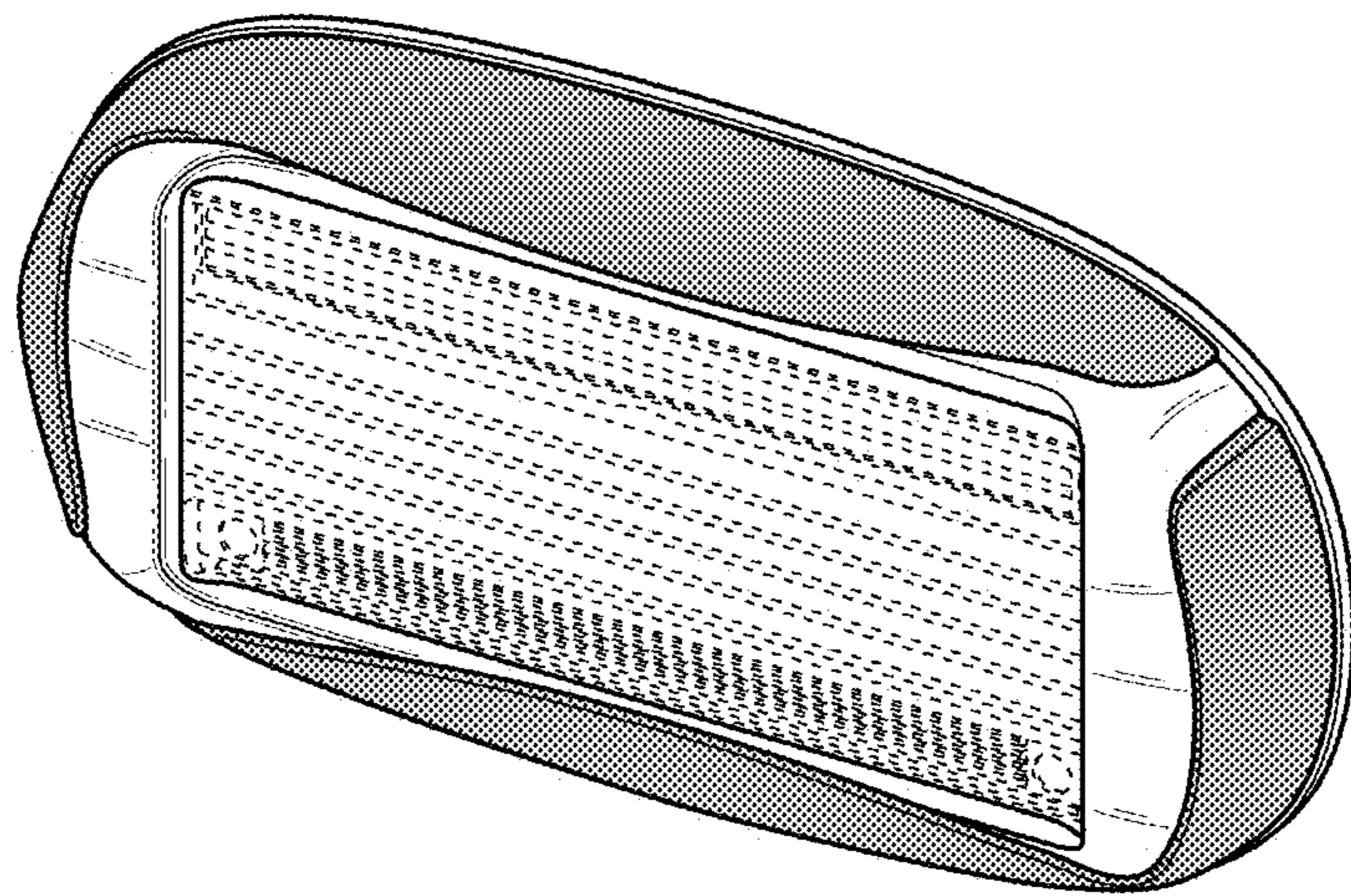

Fig. 15

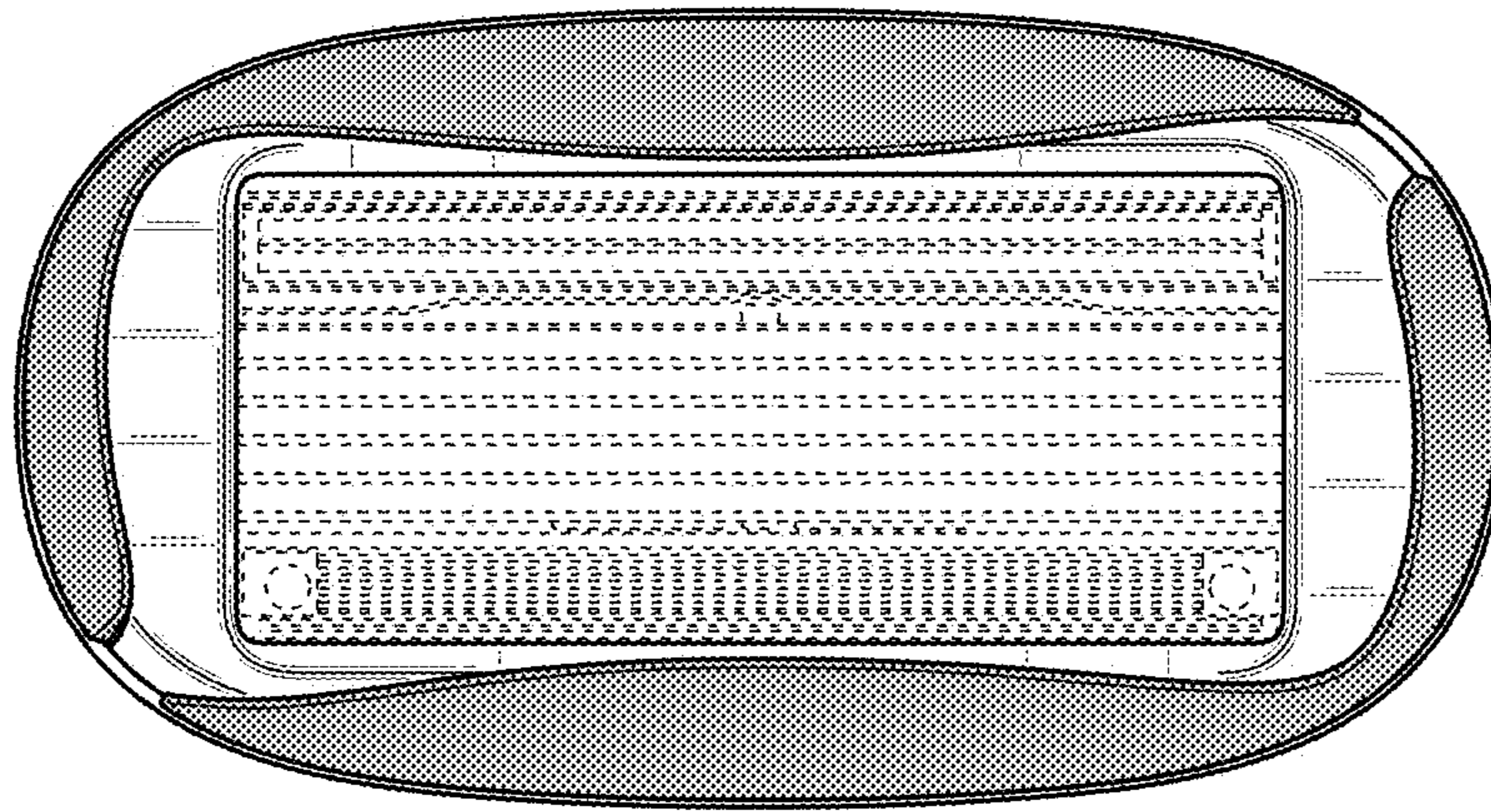

Fig. 16

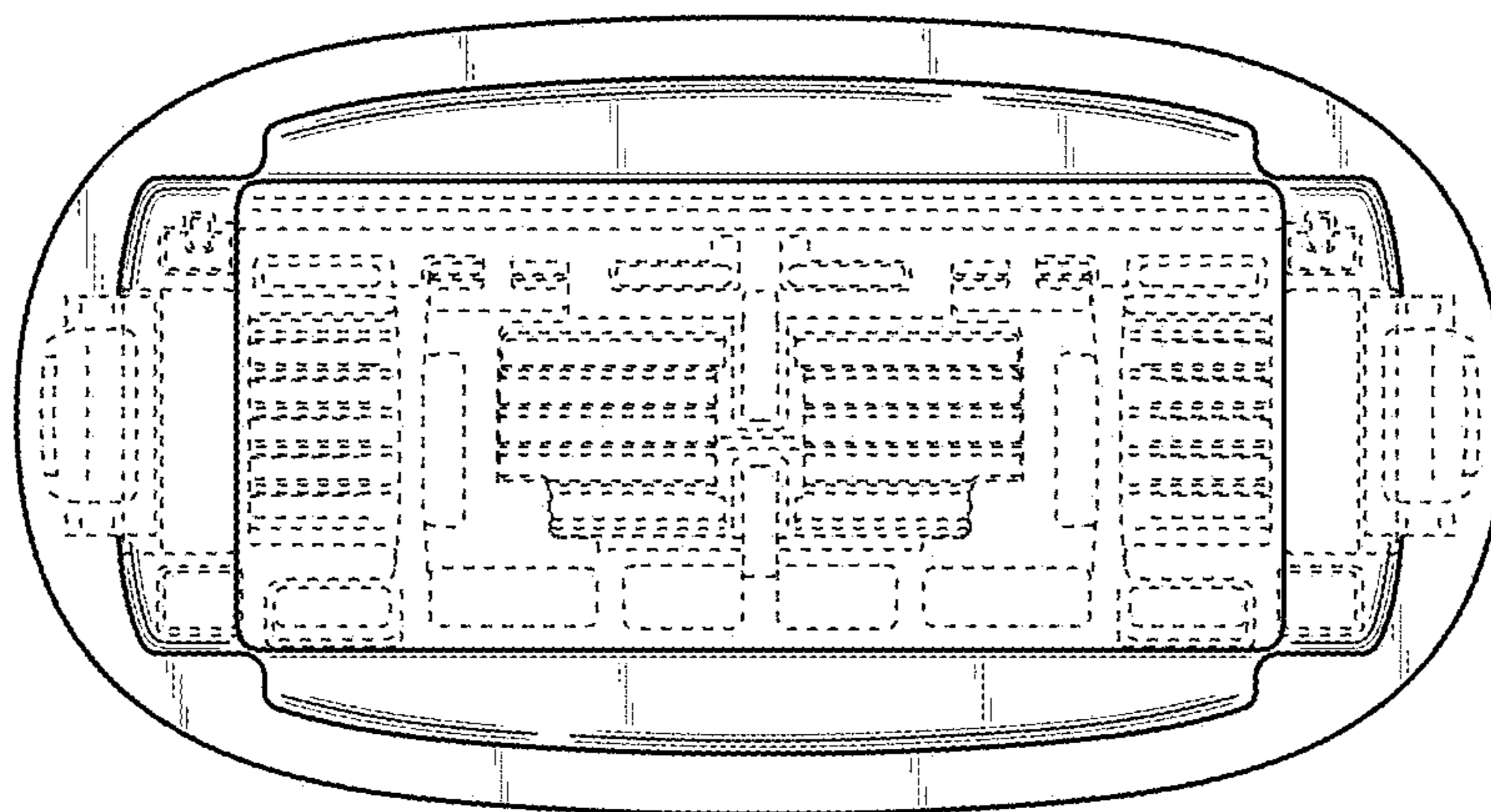

Fig. 17

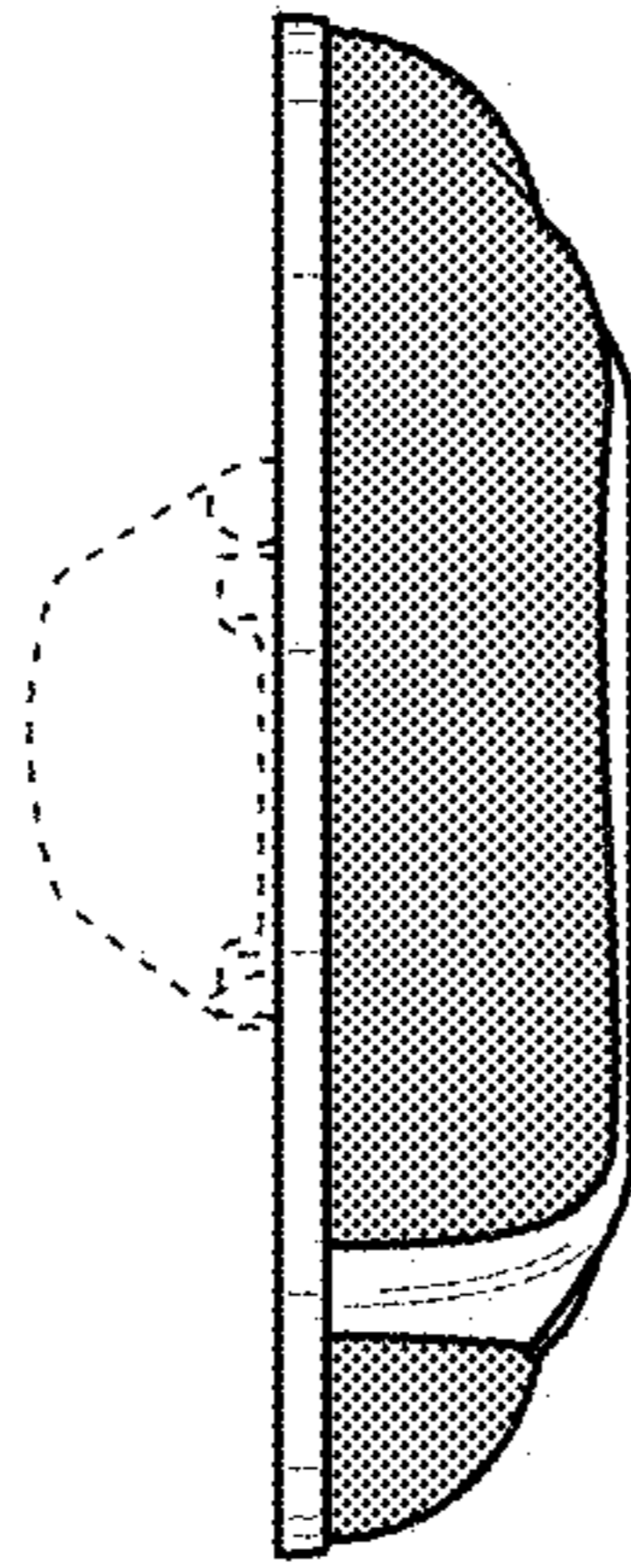

Fig. 18

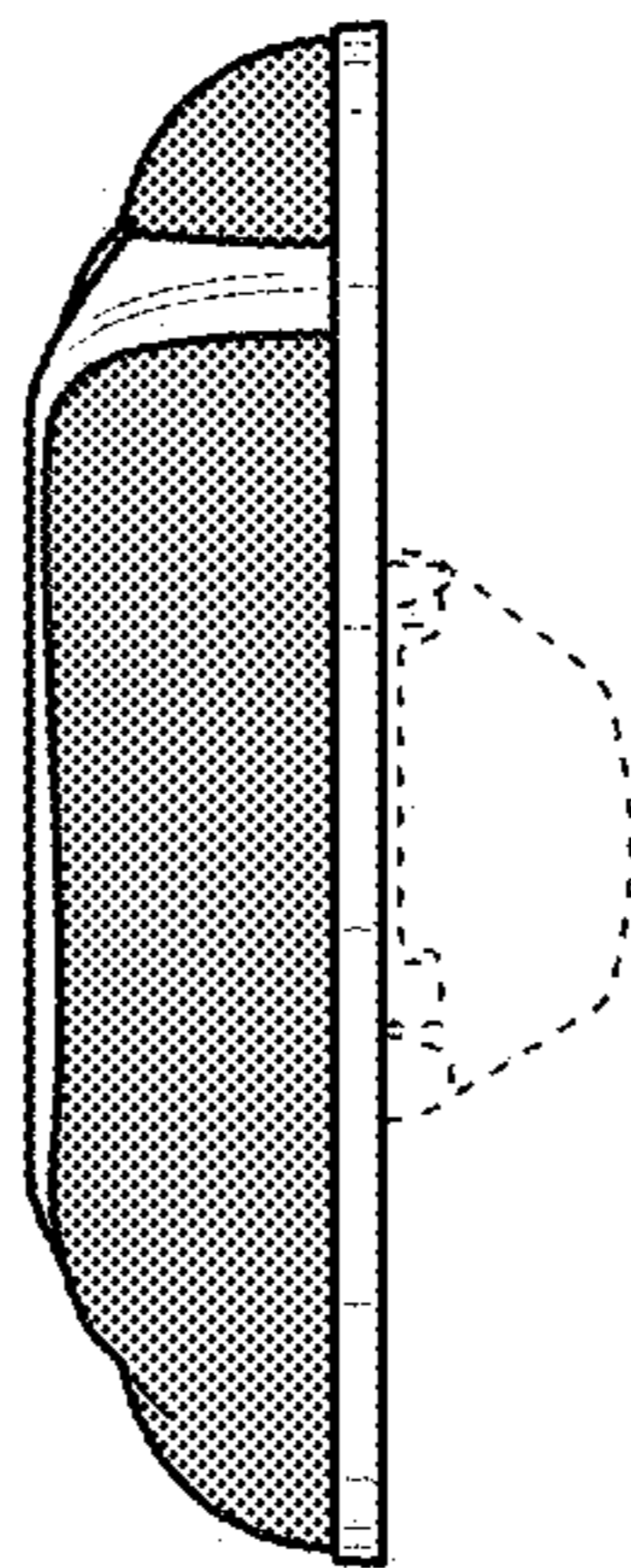

Fig. 19

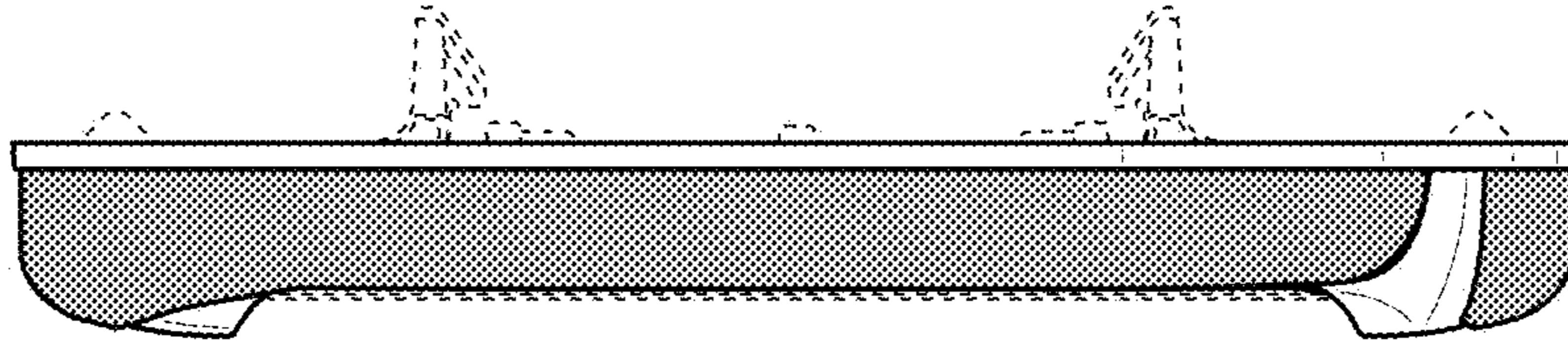

Fig. 20

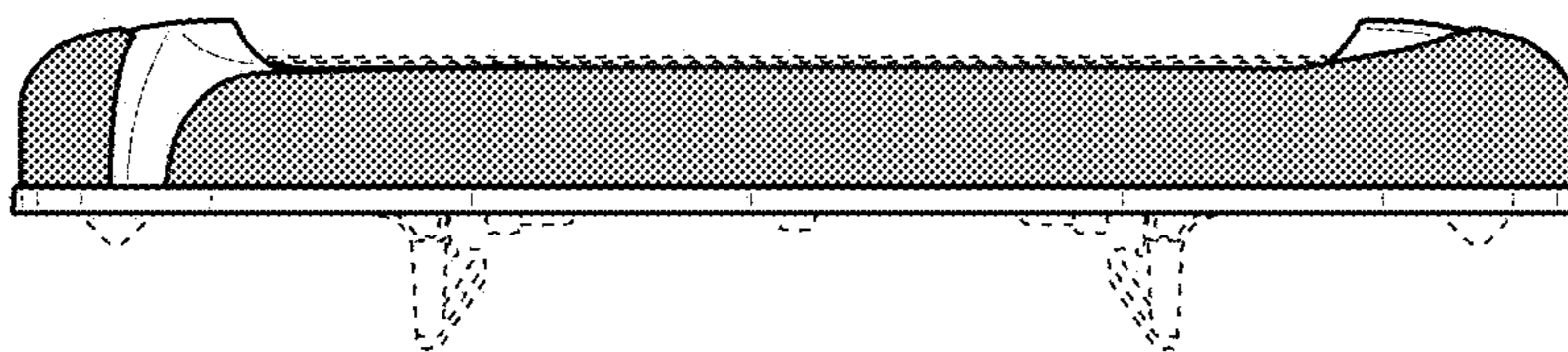

Fig. 21

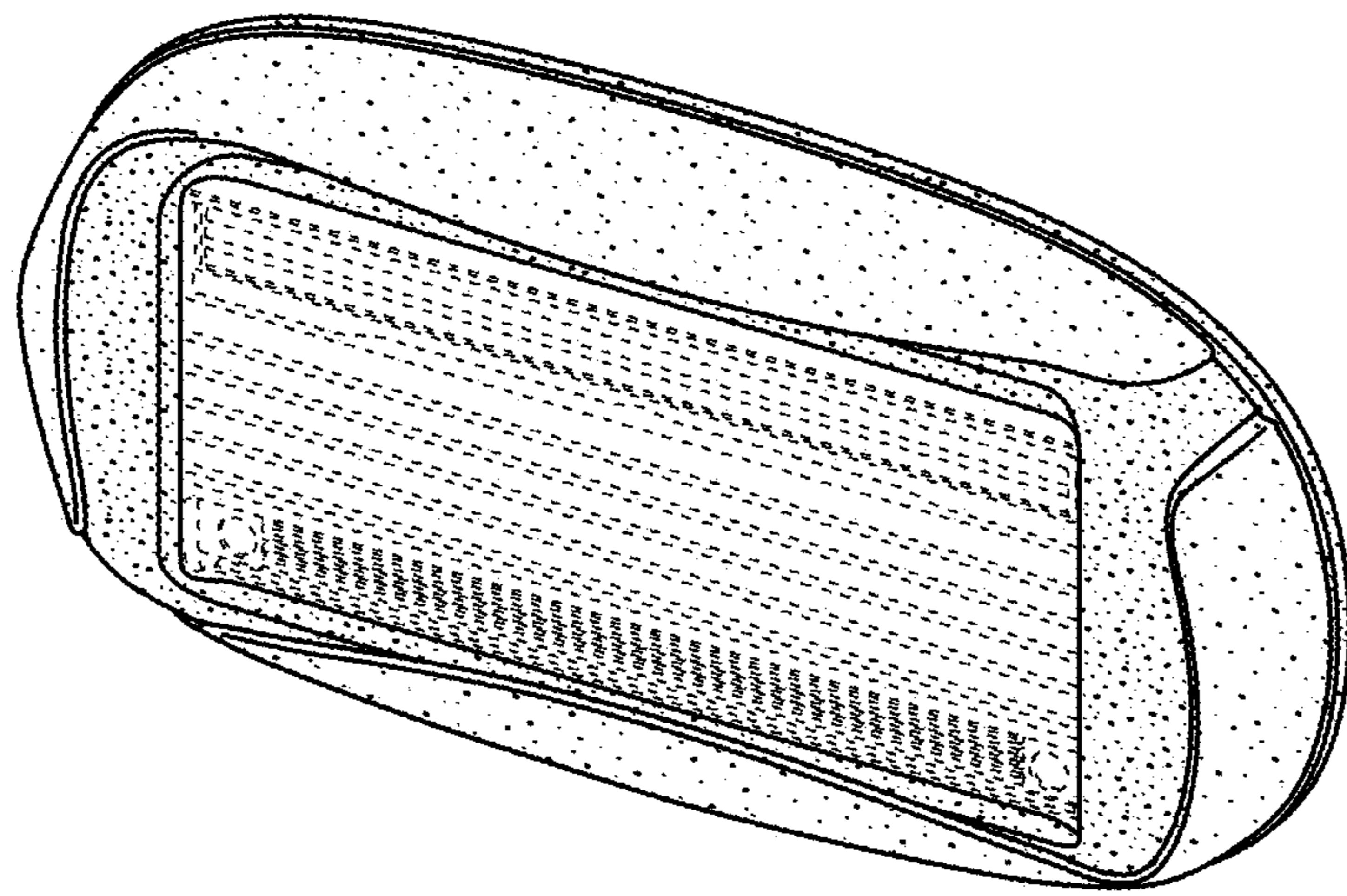

Fig. 22

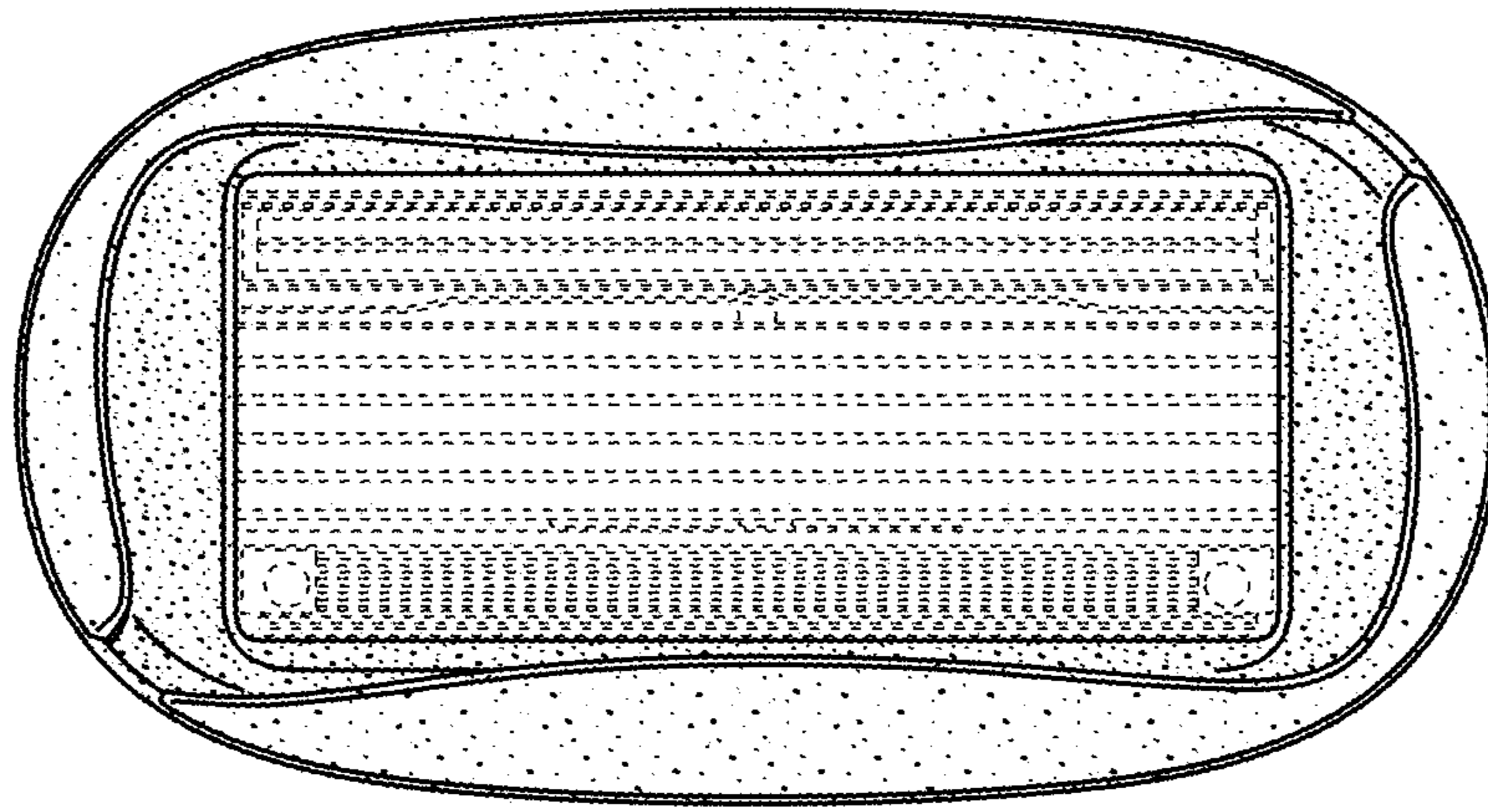

Fig. 23

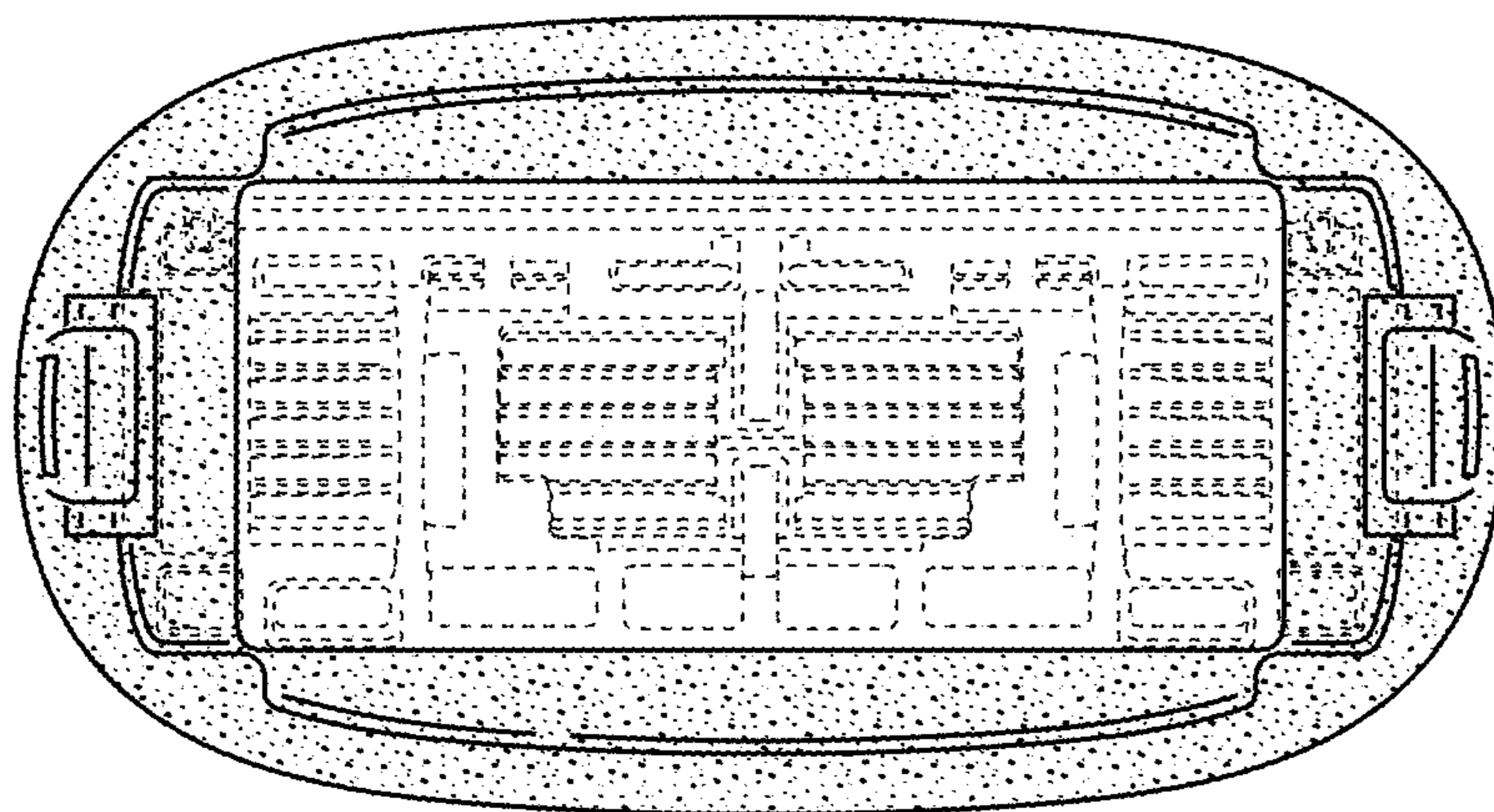

Fig. 24

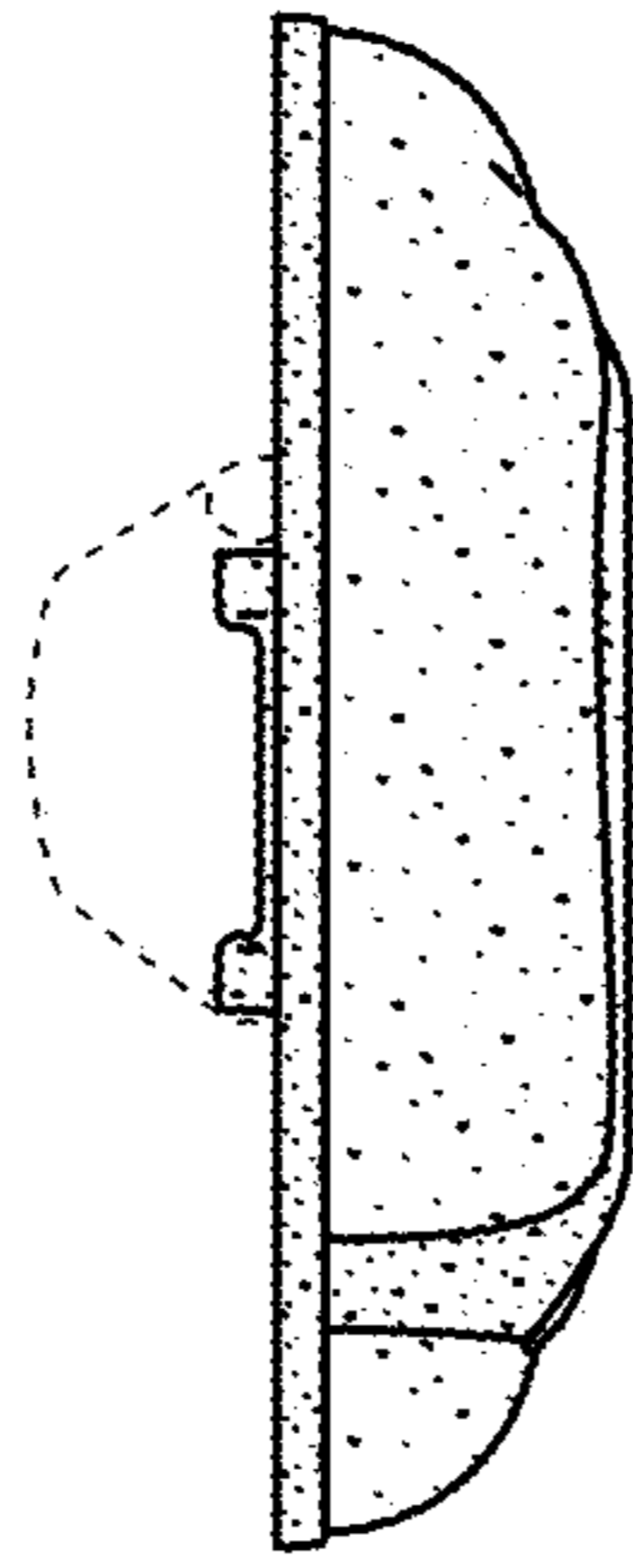

Fig. 25

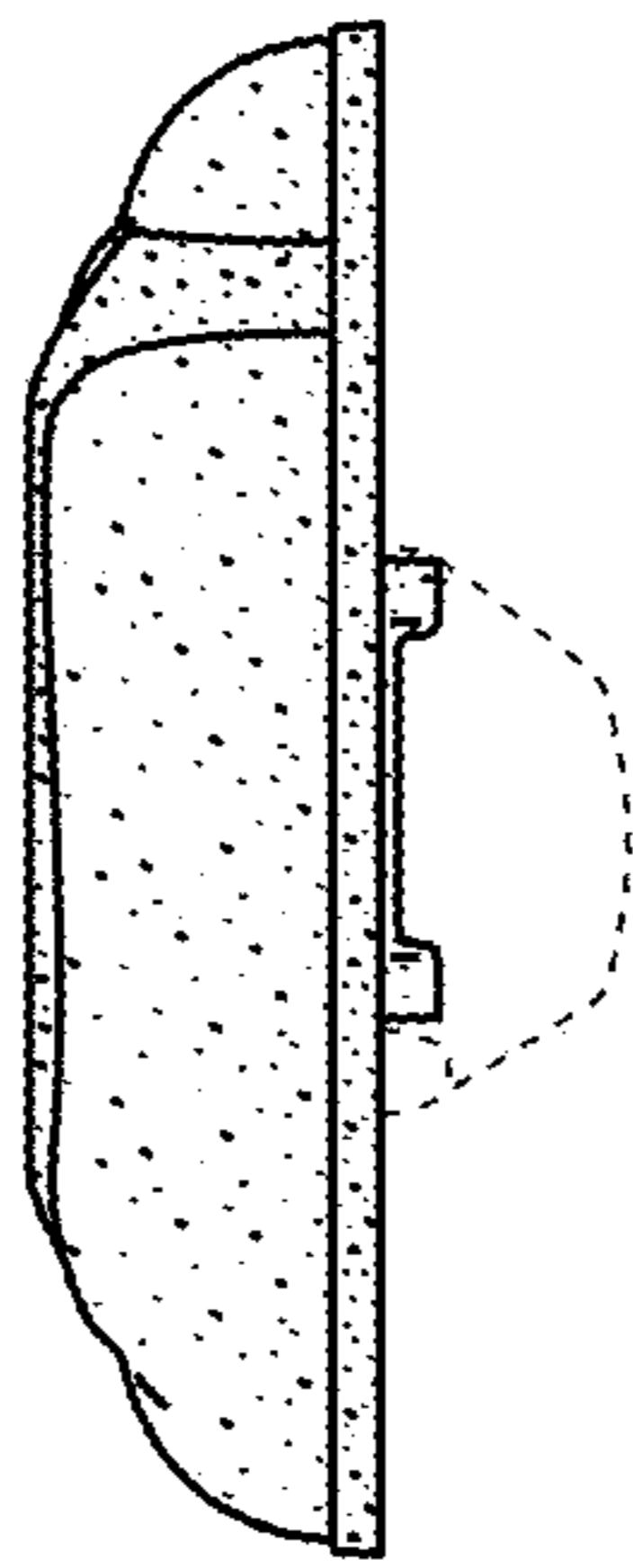

Fig. 26

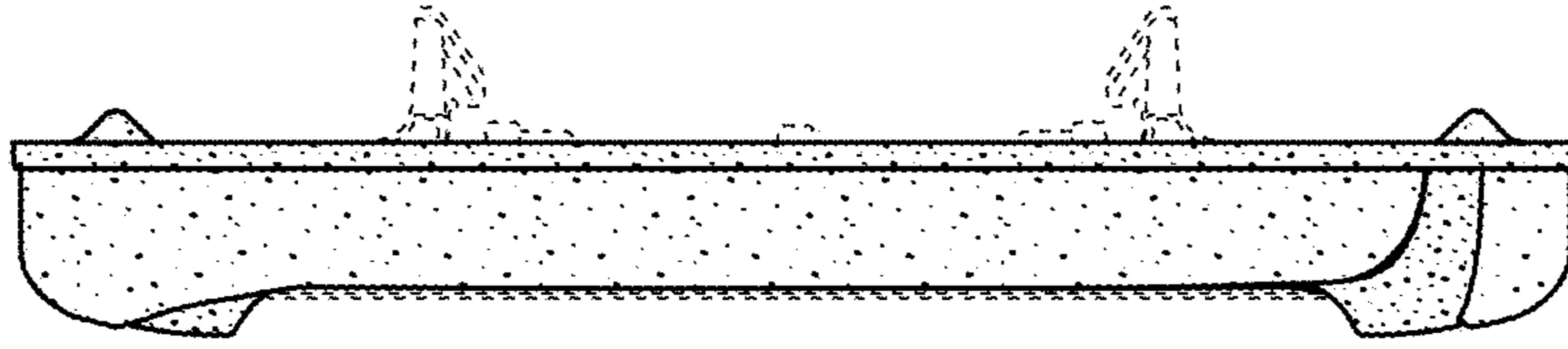

Fig. 27

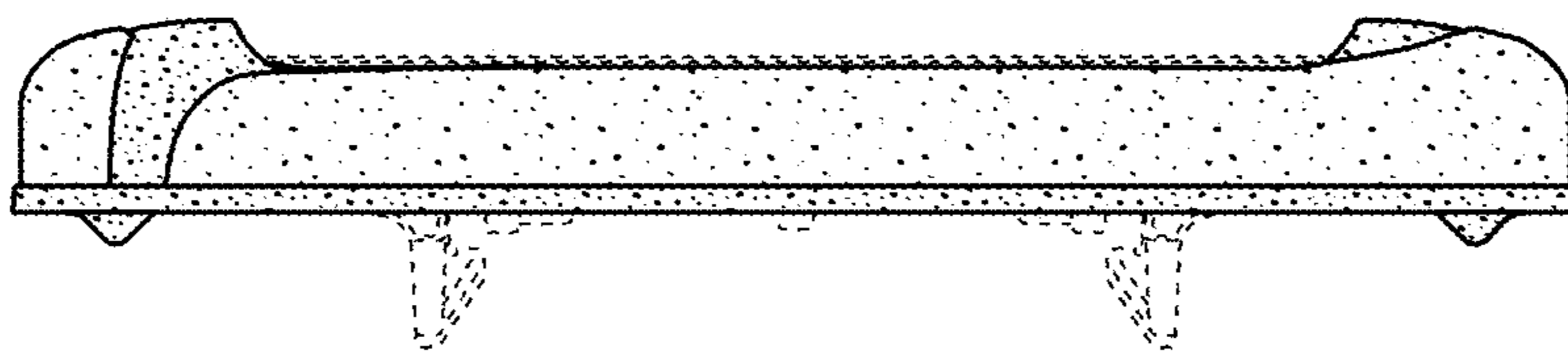

Fig. 28

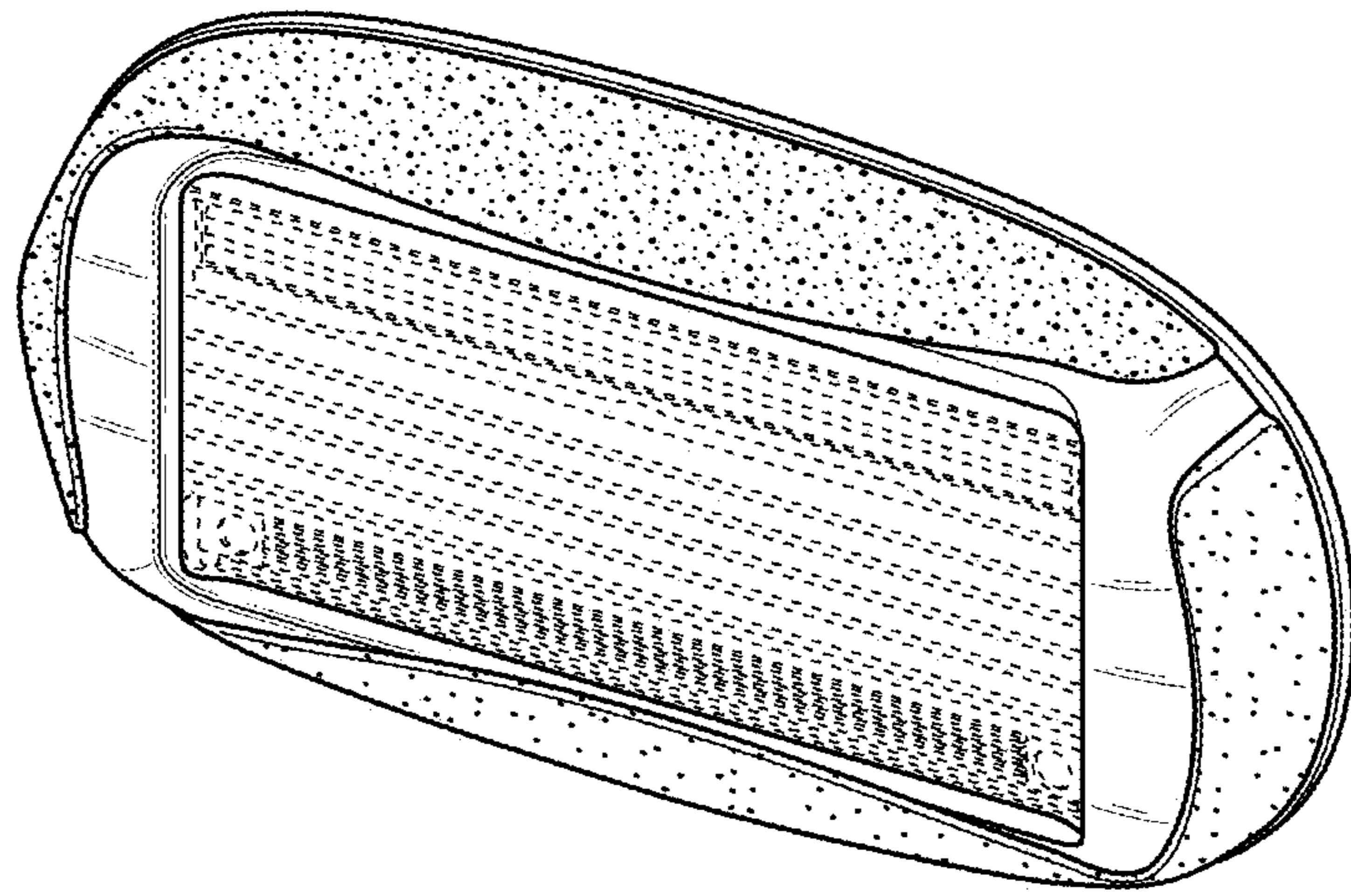

Fig. 29

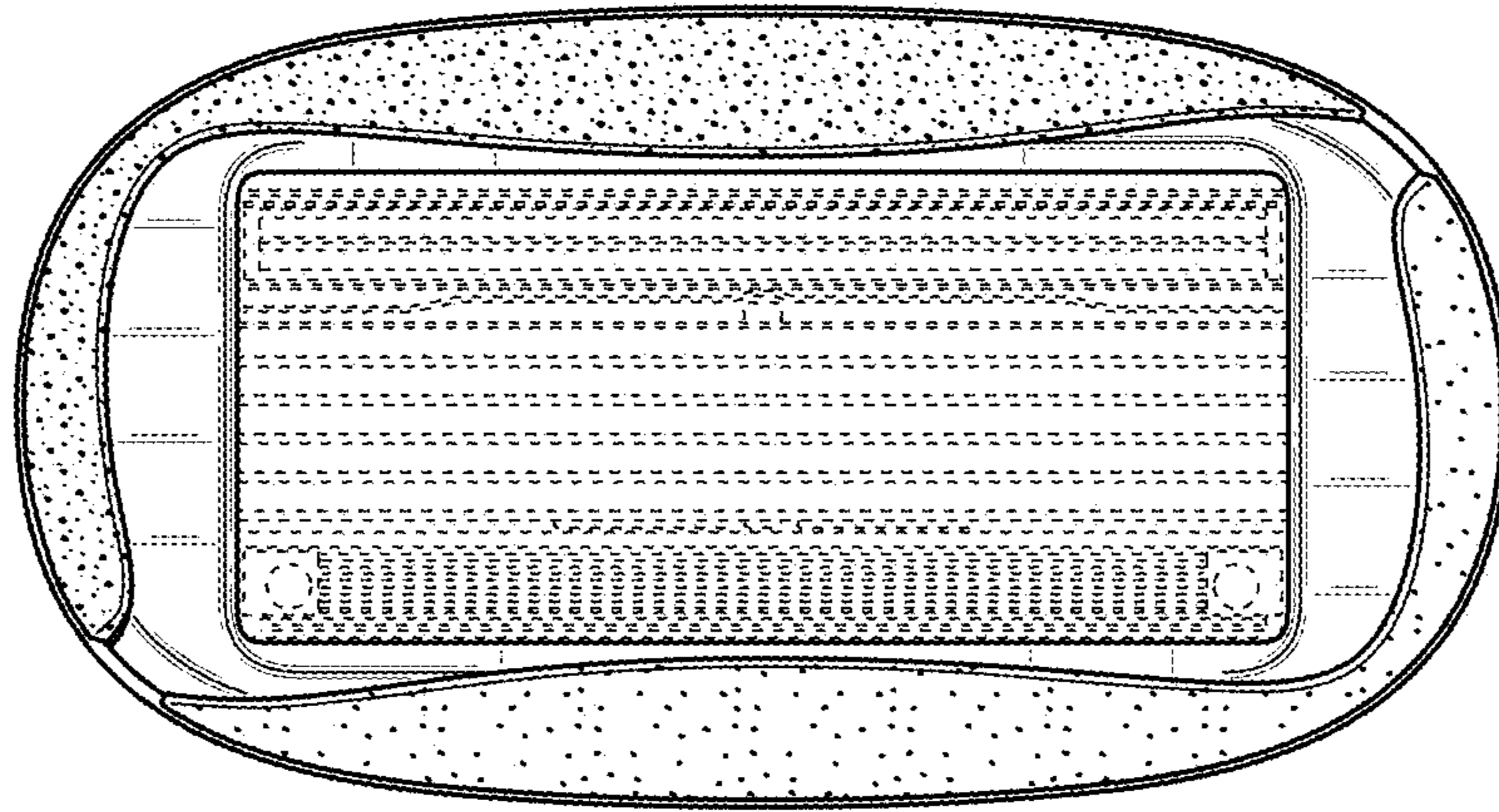

Fig. 30

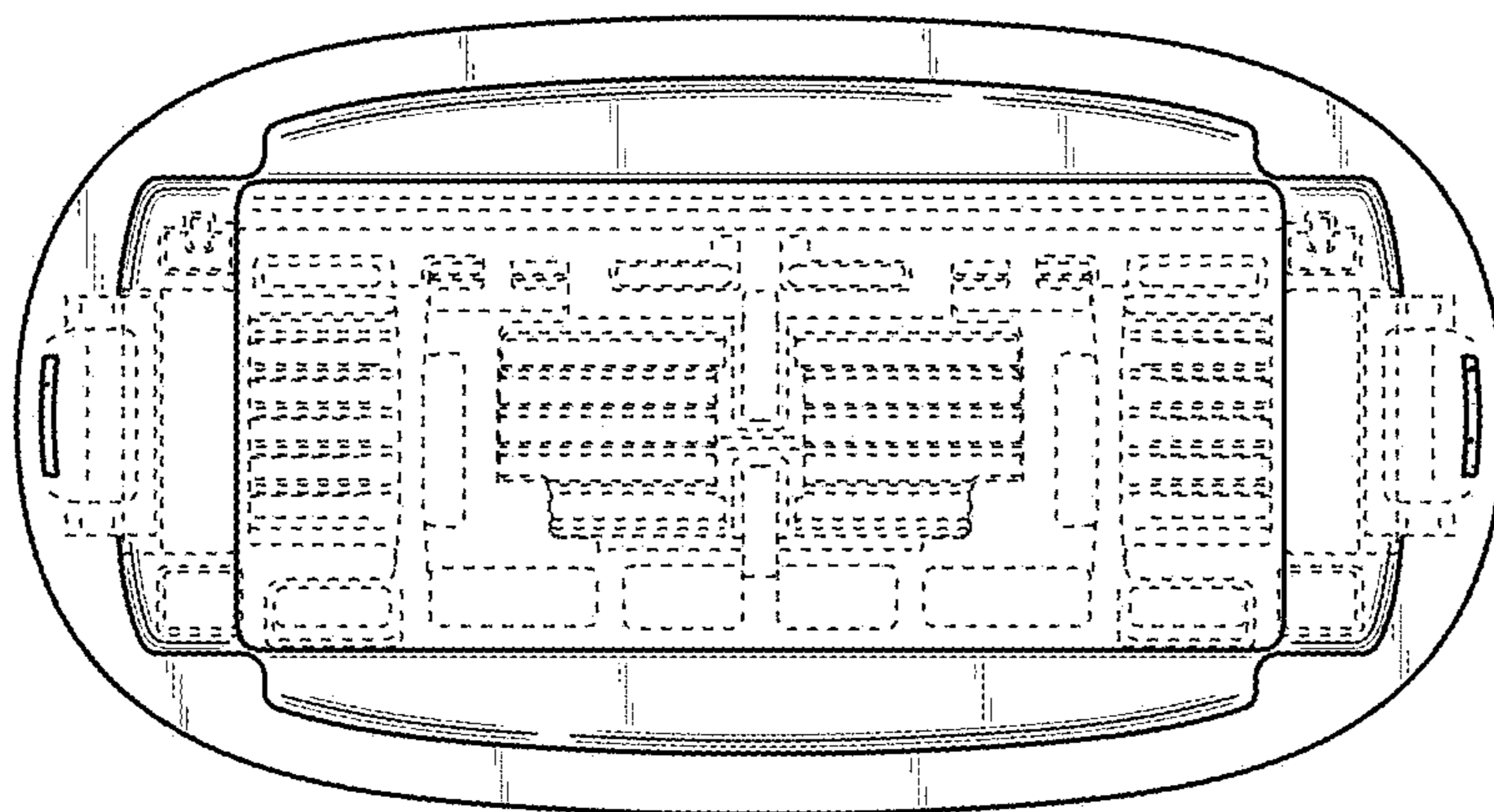

Fig. 31

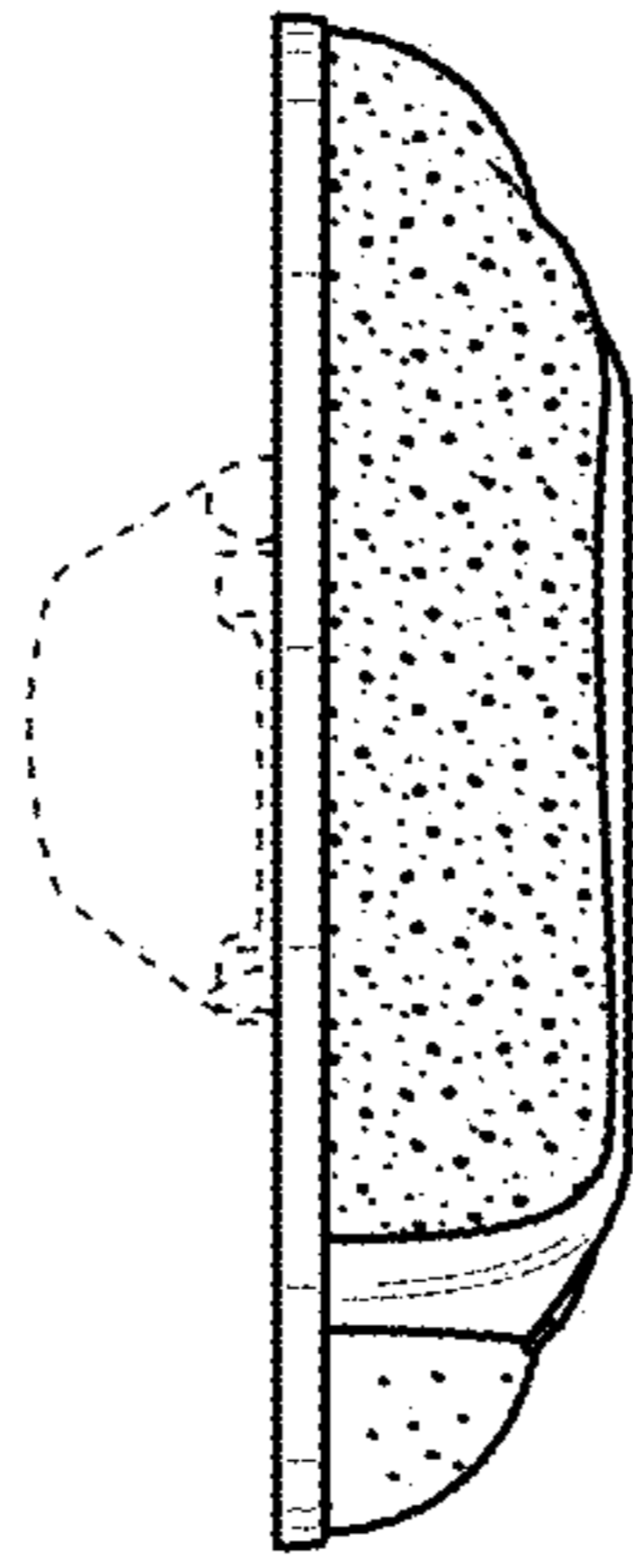

Fig. 32

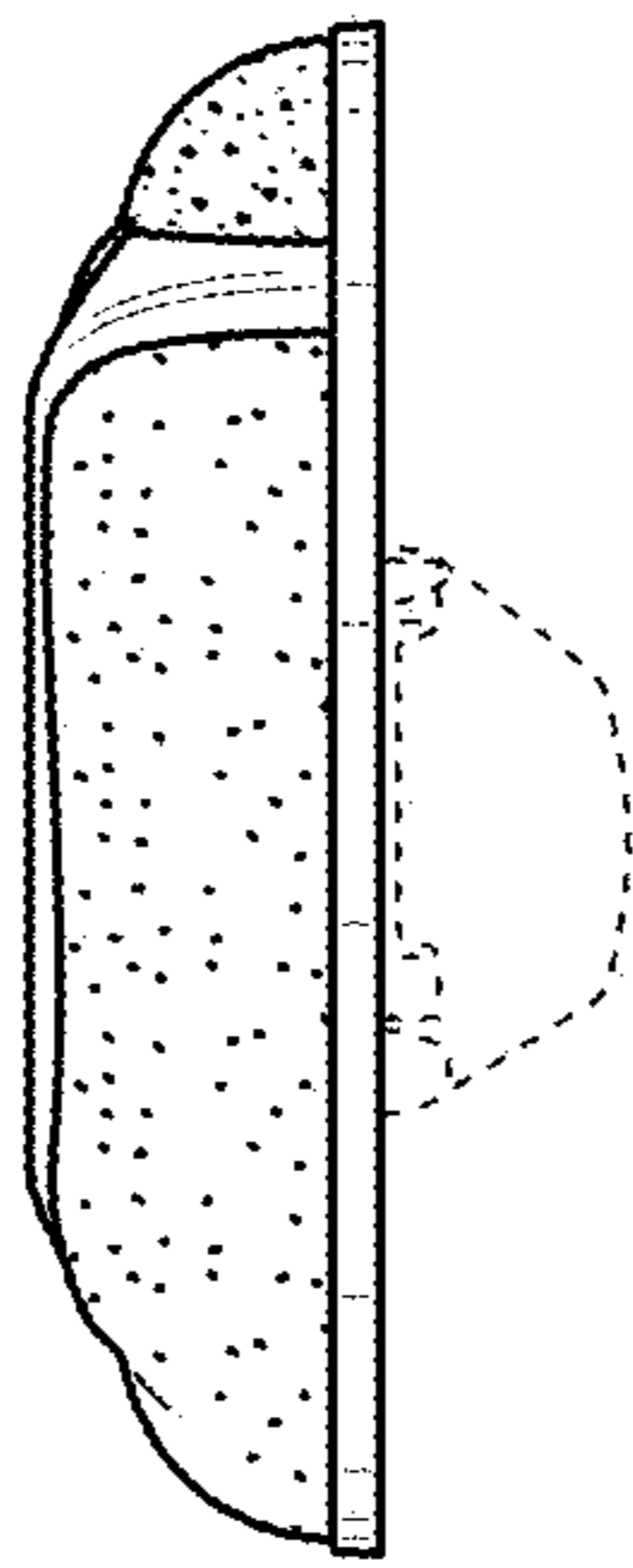

Fig. 33

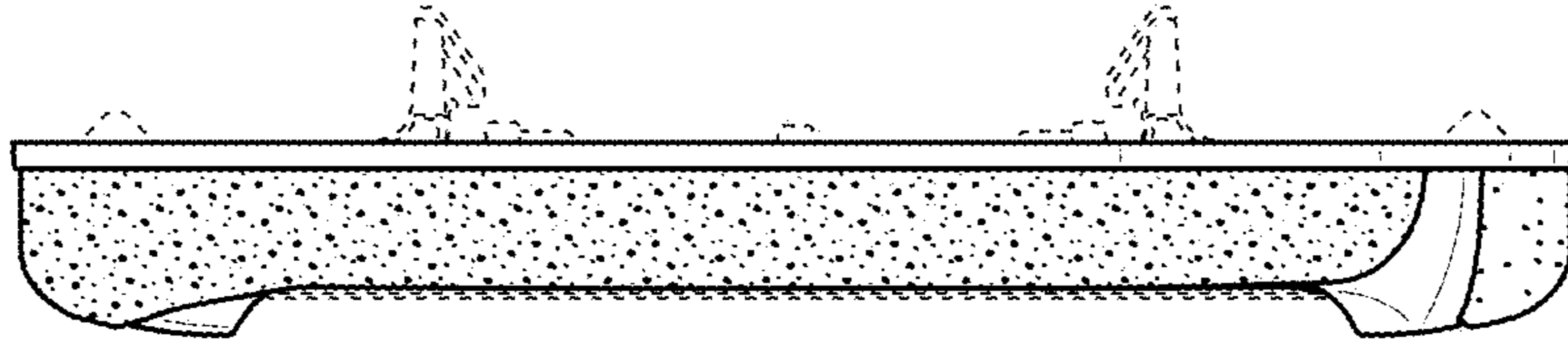

Fig. 34

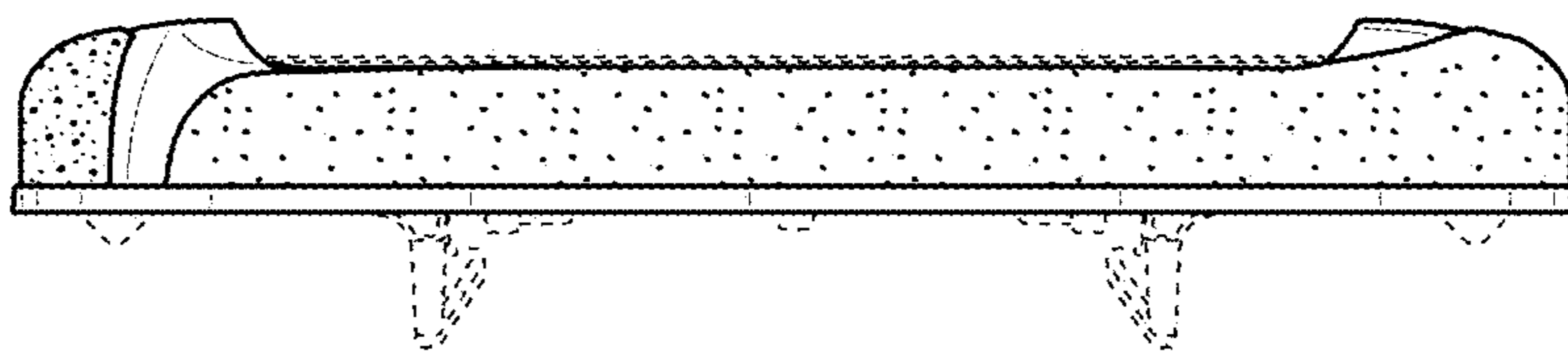

Fig. 35