

US00D872870S

(12) **United States Design Patent** (10) **Patent No.:** **US D872,870 S**  
**Thompson et al.** (45) **Date of Patent:** **\*\* \*Jan. 14, 2020**

(54) **DIAGNOSTIC INSTRUMENT**

(56) **References Cited**

(71) Applicant: **VENTANA MEDICAL SYSTEMS, INC.**, Tucson, AZ (US)  
(72) Inventors: **Michael Thompson**, Tucson, AZ (US);  
**Robert Bernstine**, Tucson, AZ (US);  
**Samuel Psota**, Tucson, AZ (US);  
**Richard Powers**, Tucson, AZ (US);  
**Jeffery Klebenow**, Tucson, AZ (US);  
**Chirayu Patel**, Tucson, AZ (US);  
**Jenna Lefkowits**, Tucson, AZ (US)

U.S. PATENT DOCUMENTS

D404,829 S \* 1/1999 Chomka ..... D24/220  
D607,575 S \* 1/2010 Walsh ..... D24/216  
D694,899 S \* 12/2013 Cook ..... D24/216  
D718,462 S \* 11/2014 Cook ..... D24/216  
D728,121 S \* 4/2015 Cook ..... D24/216

\* cited by examiner

*Primary Examiner* — George D. Kirschbaum  
(74) *Attorney, Agent, or Firm* — Klarquist Sparkman, LLP

(73) Assignee: **Ventana Medical Systems, Inc.**, Tucson, AZ (US)

(57) **CLAIM**

The ornamental design for a diagnostic instrument, as shown and described.

(\* ) Notice: This patent is subject to a terminal disclaimer.

**DESCRIPTION**

(\*\*) Term: **15 Years**

1.-2. Diagnostic instruments

(21) Appl. No.: **35/001,474**

1.1 : Perspective

1.2 : Front

1.3 : Back

1.4 : Top

1.5 : Bottom

1.6 : Left

1.7 : Right

1.8 : Perspective

(22) Filed: **Dec. 22, 2017**

2.1 : Perspective

2.2 : Front

2.3 : Back

2.4 : Top

2.5 : Bottom

2.6 : Left

2.7 : Right

2.8 : Perspective

(80) **Hague Agreement Data**

Int. Filing Date: **Dec. 22, 2017**

Int. Reg. No.: **DM/101383**

Int. Reg. Date: **Dec. 22, 2017**

Int. Reg. Pub. Date: **Jun. 8, 2018**

(51) **LOC (12) Cl.** ..... **24-02**

(52) **U.S. Cl.**  
USPC ..... **D24/216**

(58) **Field of Classification Search**  
USPC ..... D24/216, 220, 169, 225  
See application file for complete search history.

The broken lines showings of casters, hinges, access panels and vents form no part of the claimed designs.

**1 Claim, 14 Drawing Sheets**

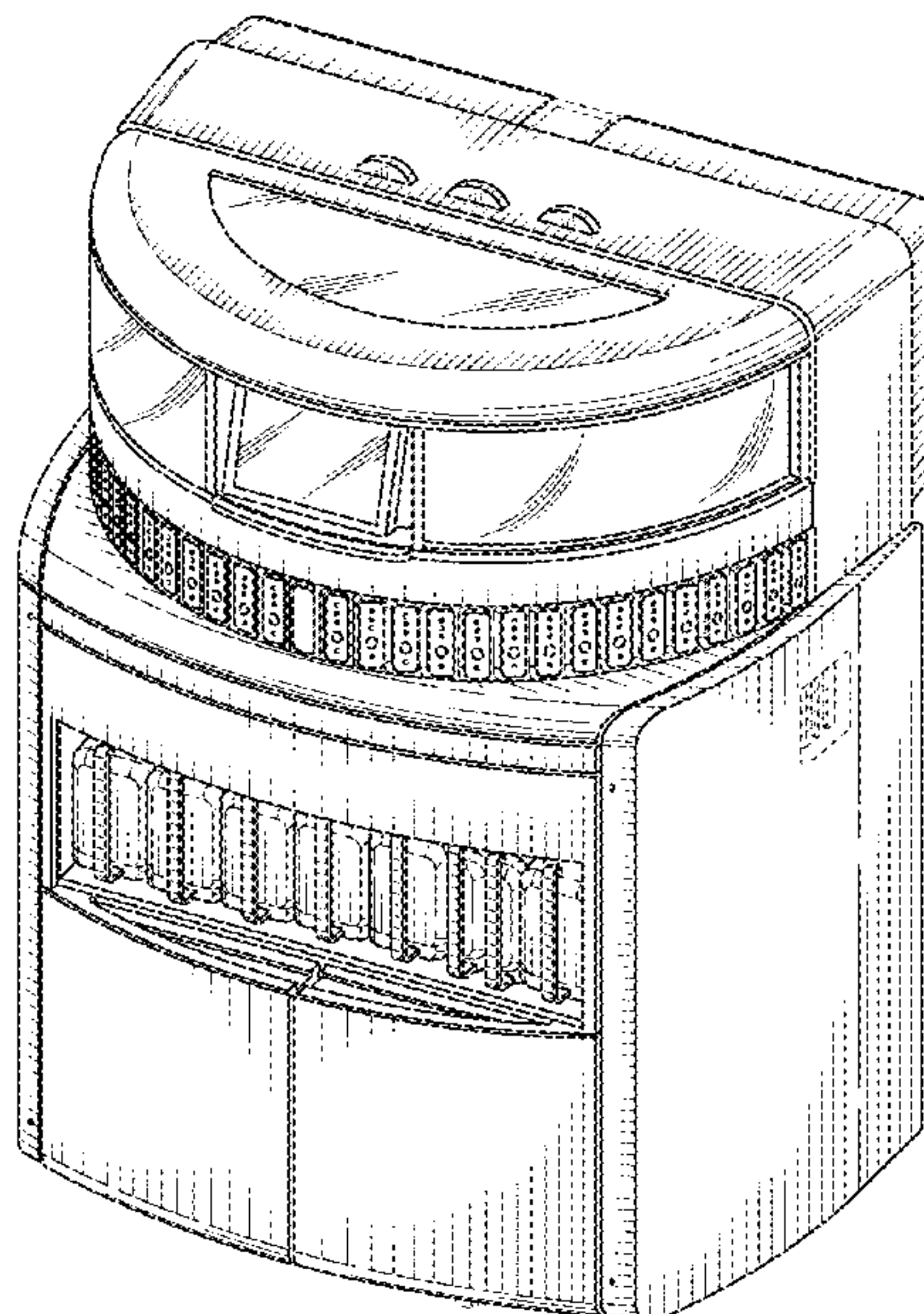

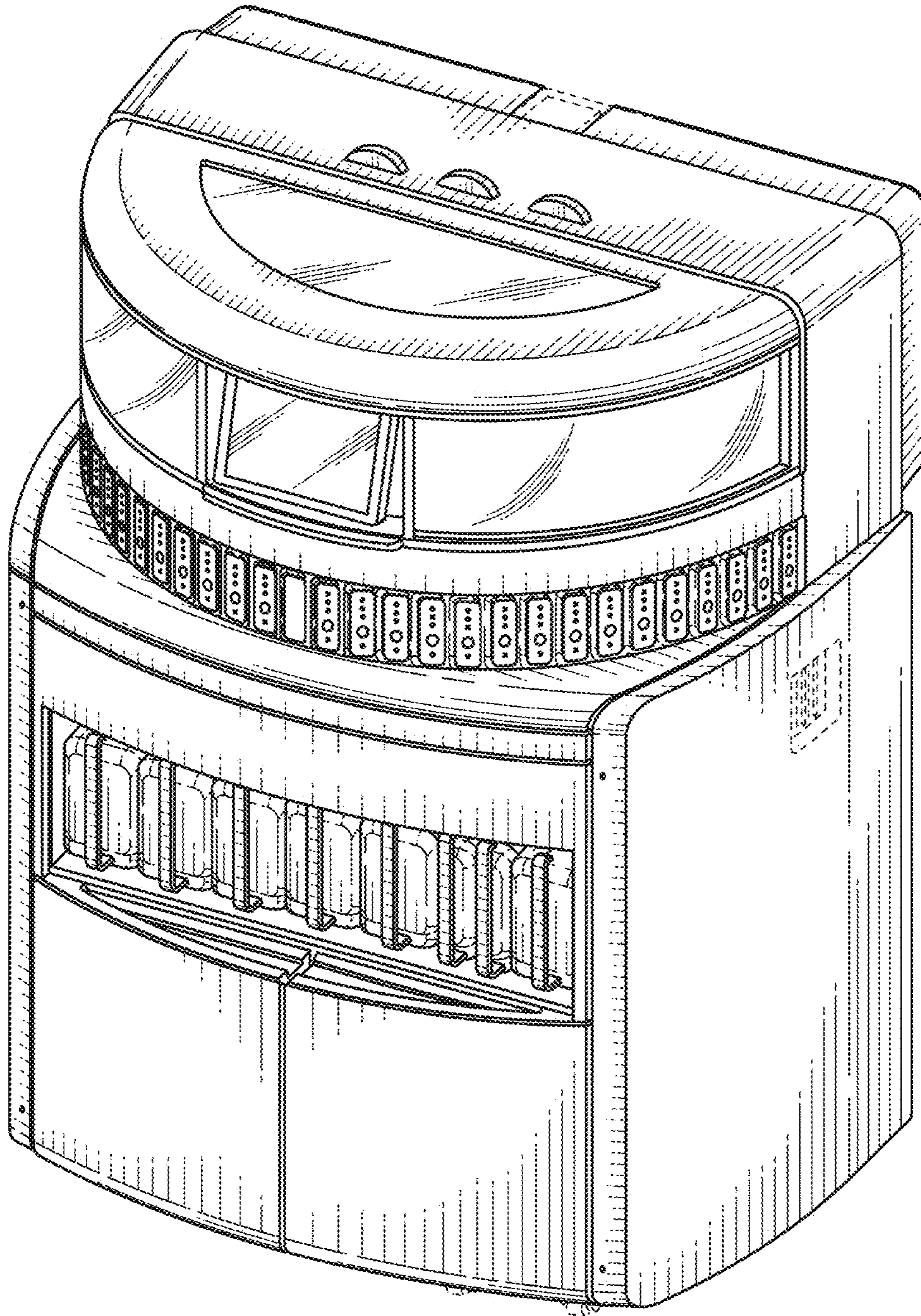

FIG. 1.1



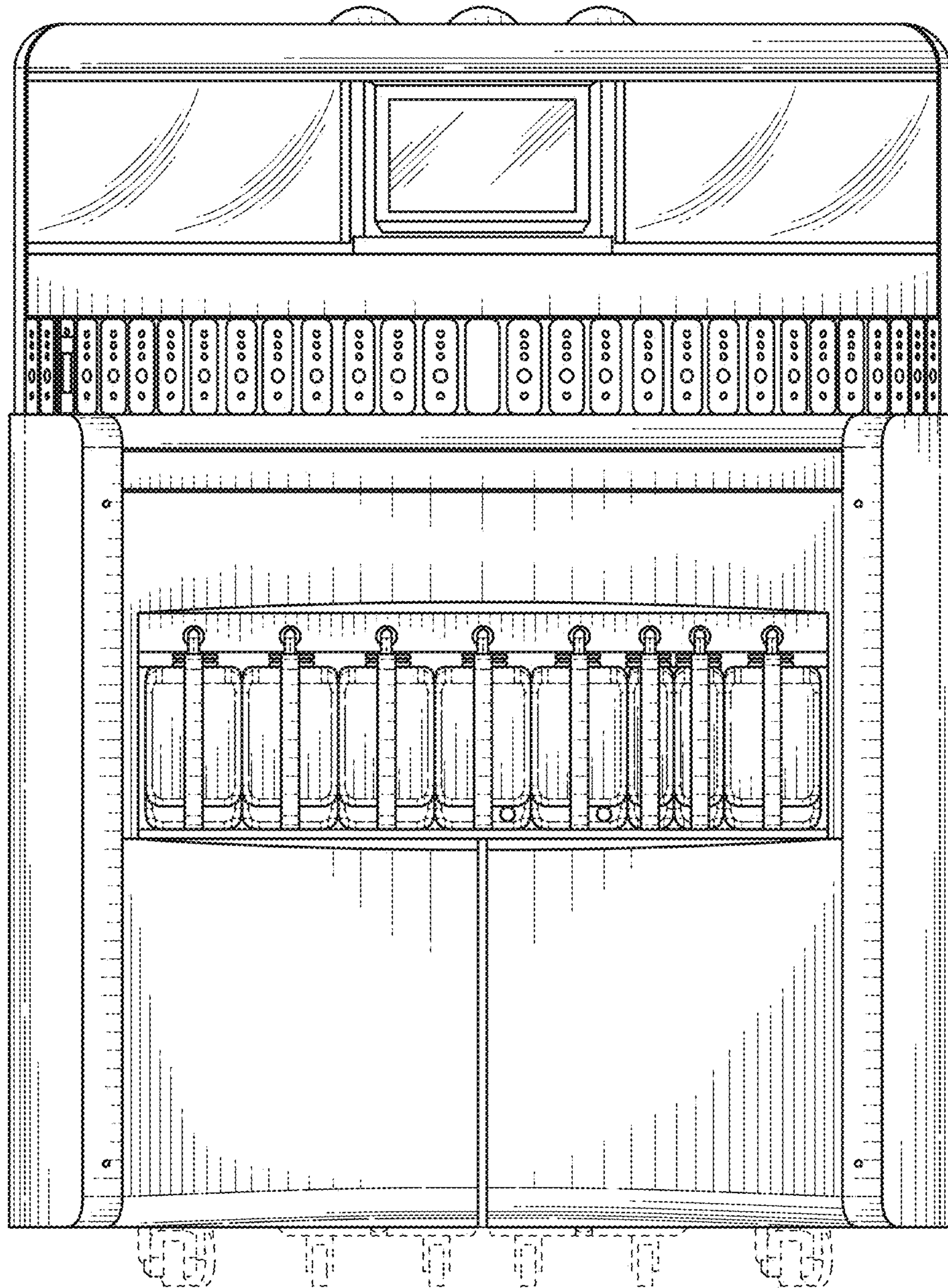

FIG. 12

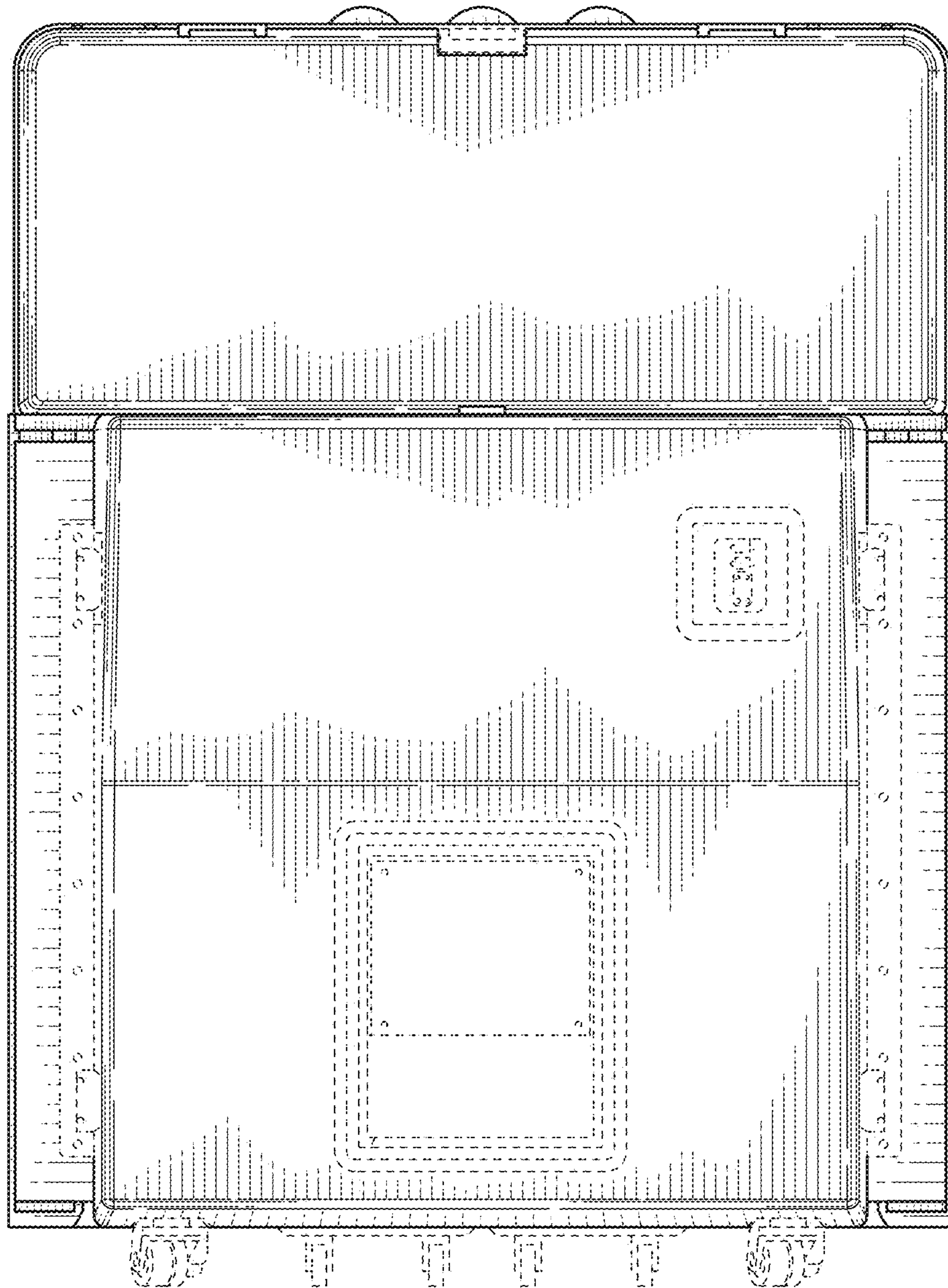

FIG. 13

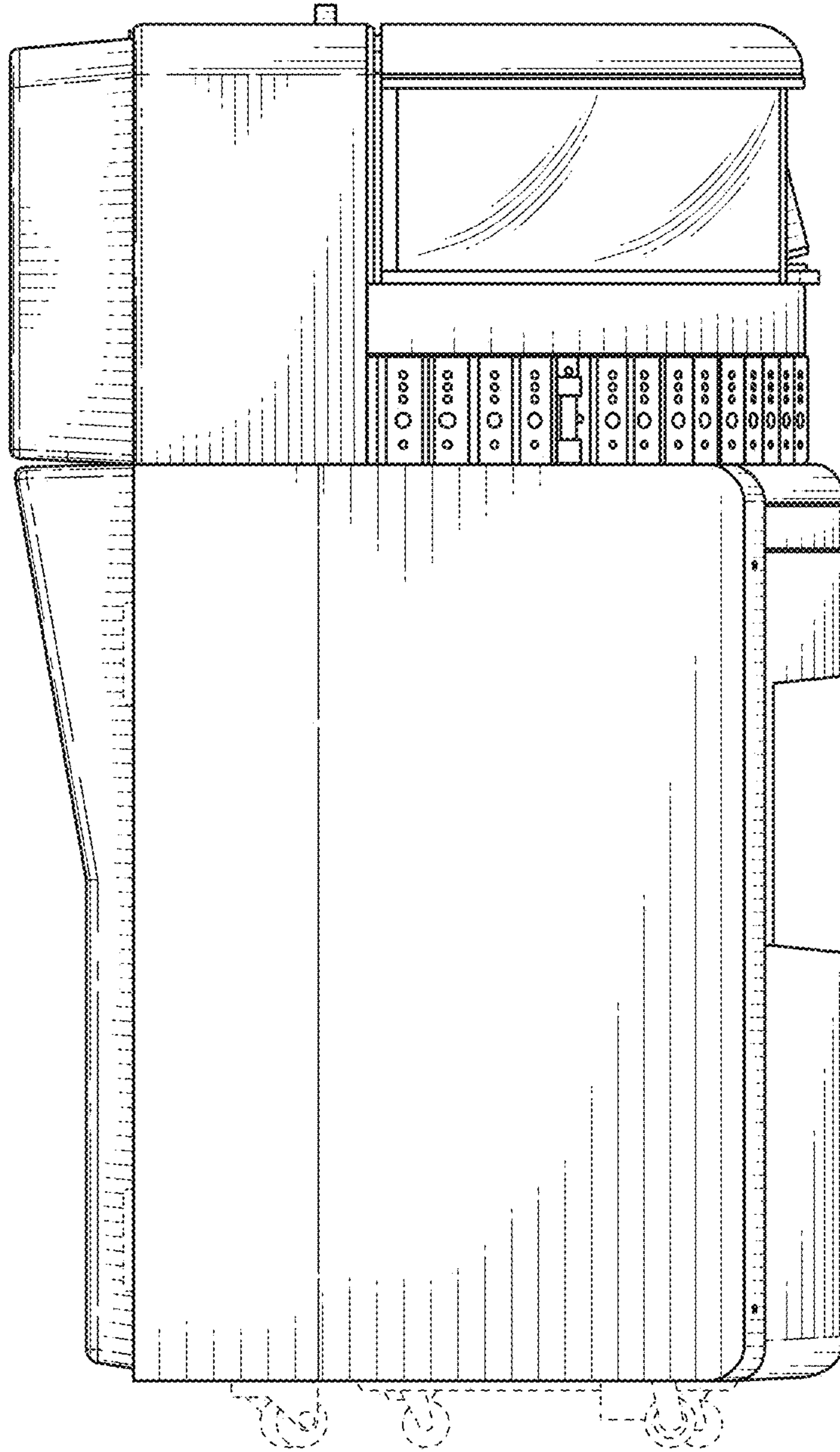

FIG. 14



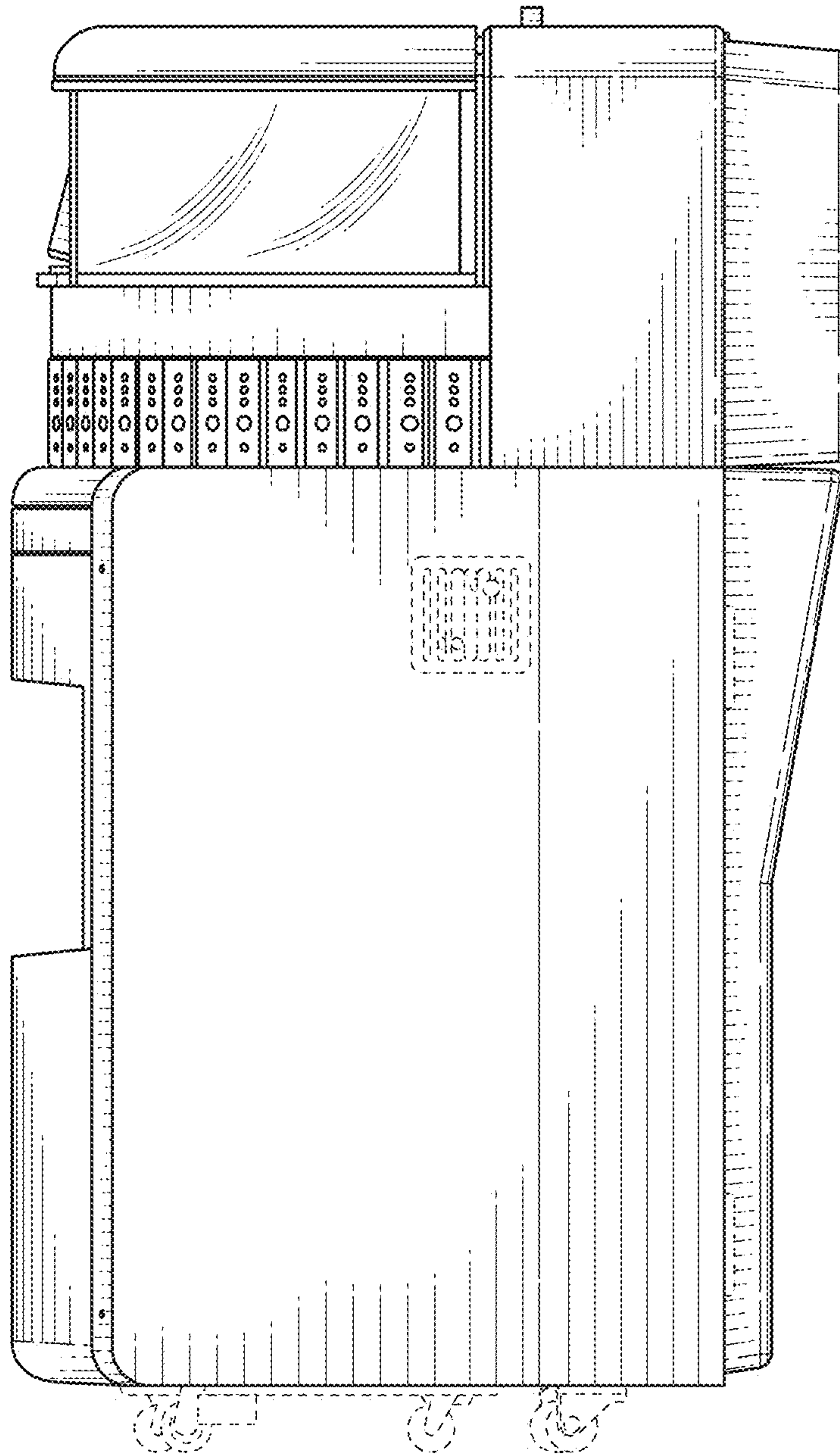

FIG. 15

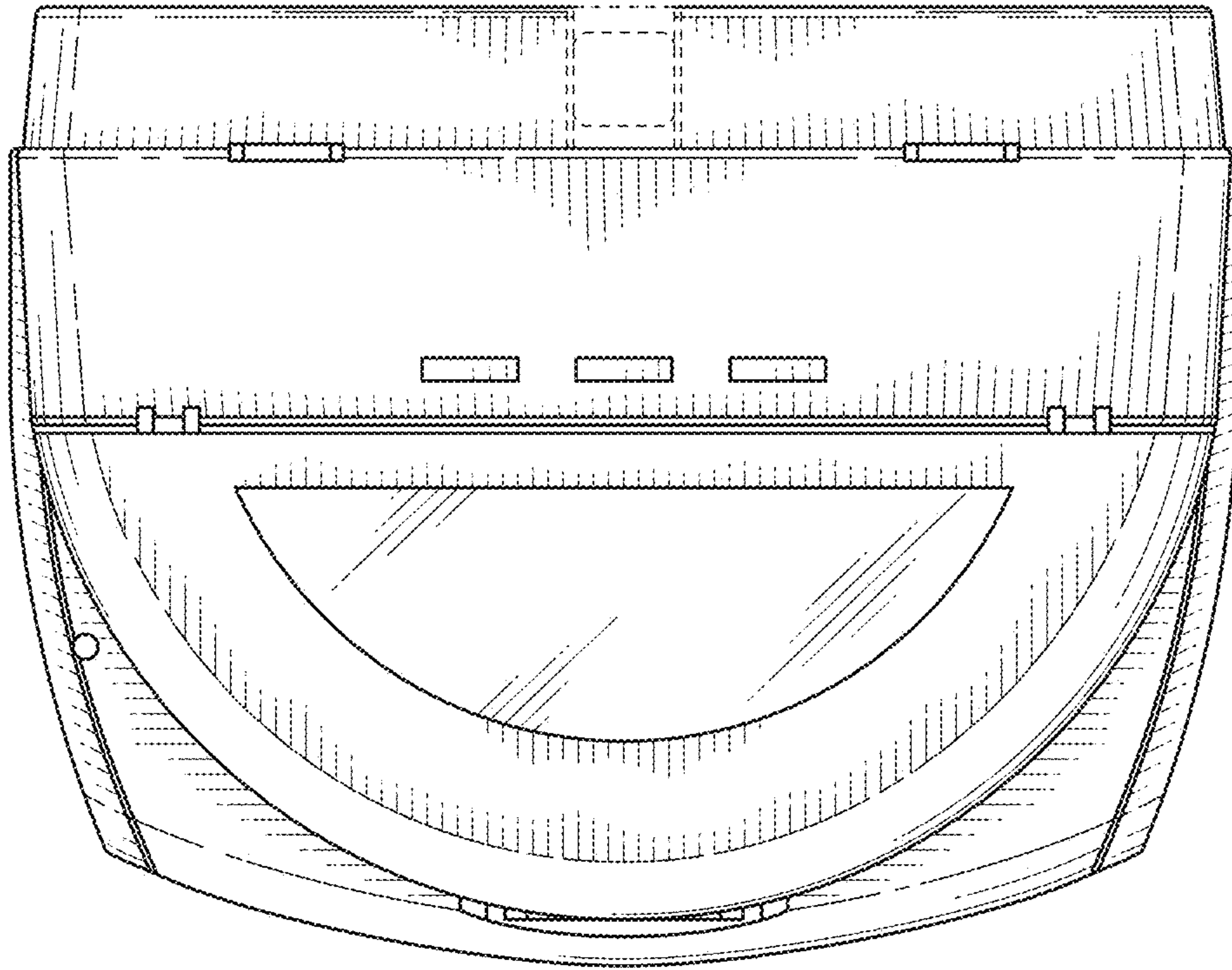

FIG. 16

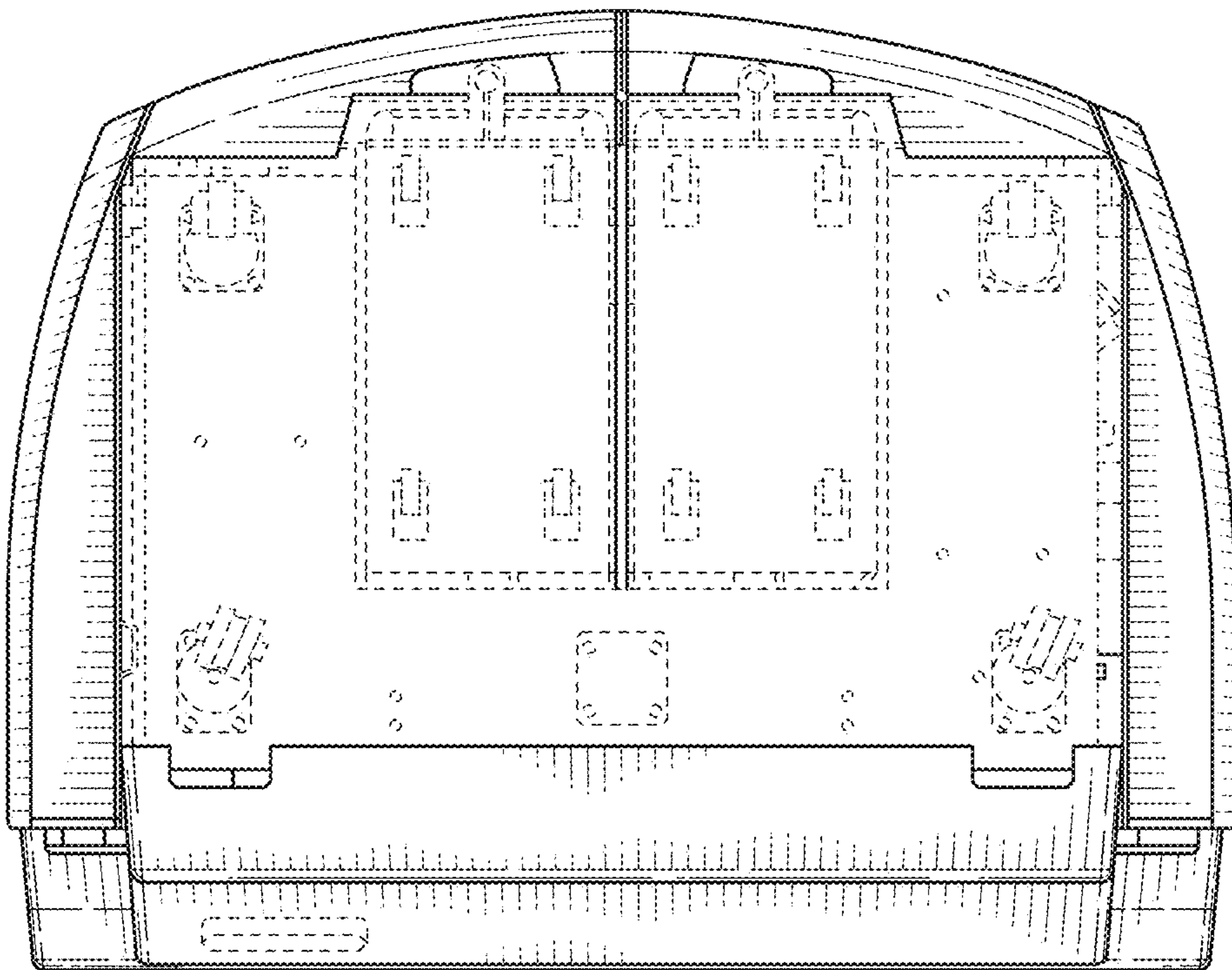

FIG. 17



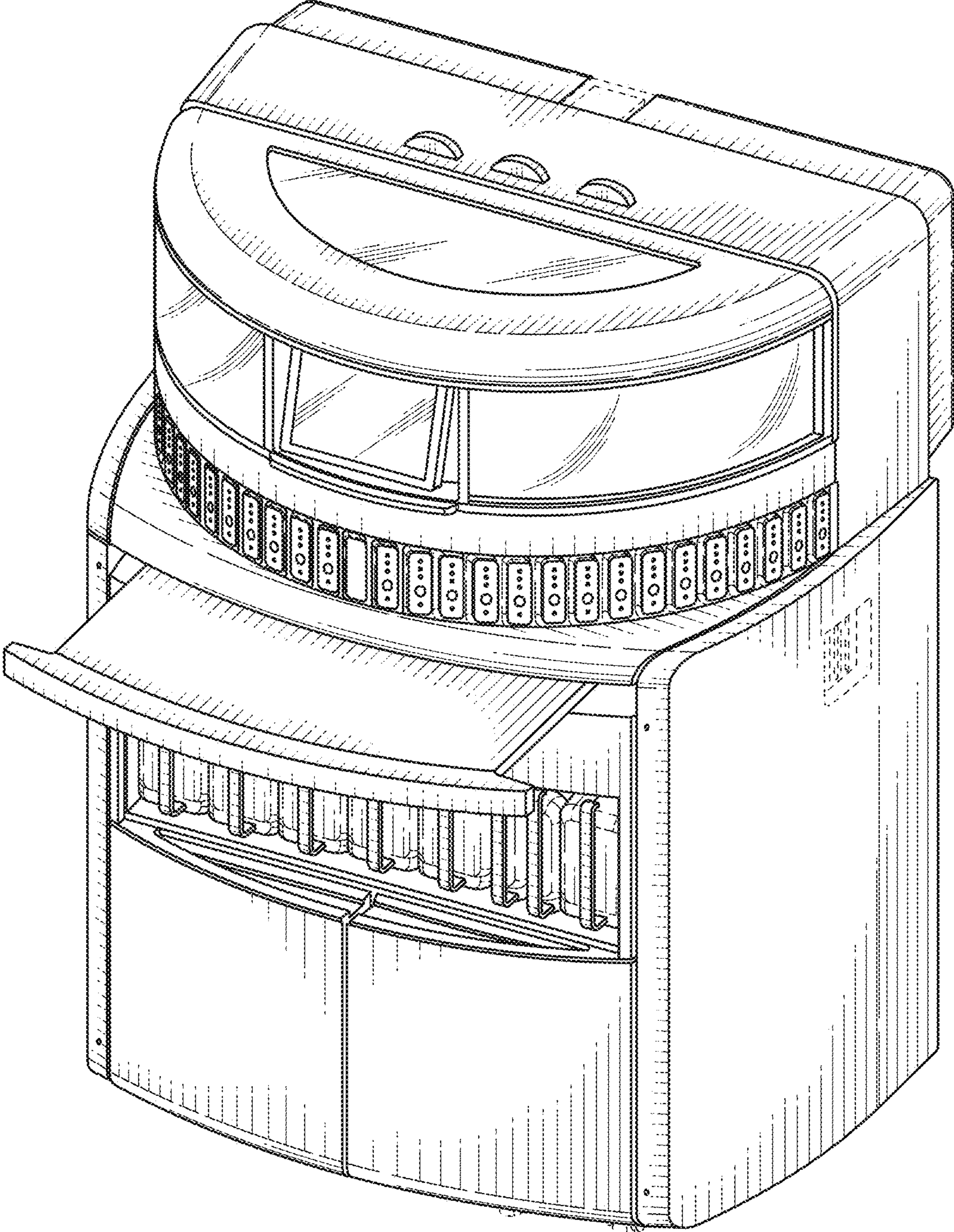

FIG. 18



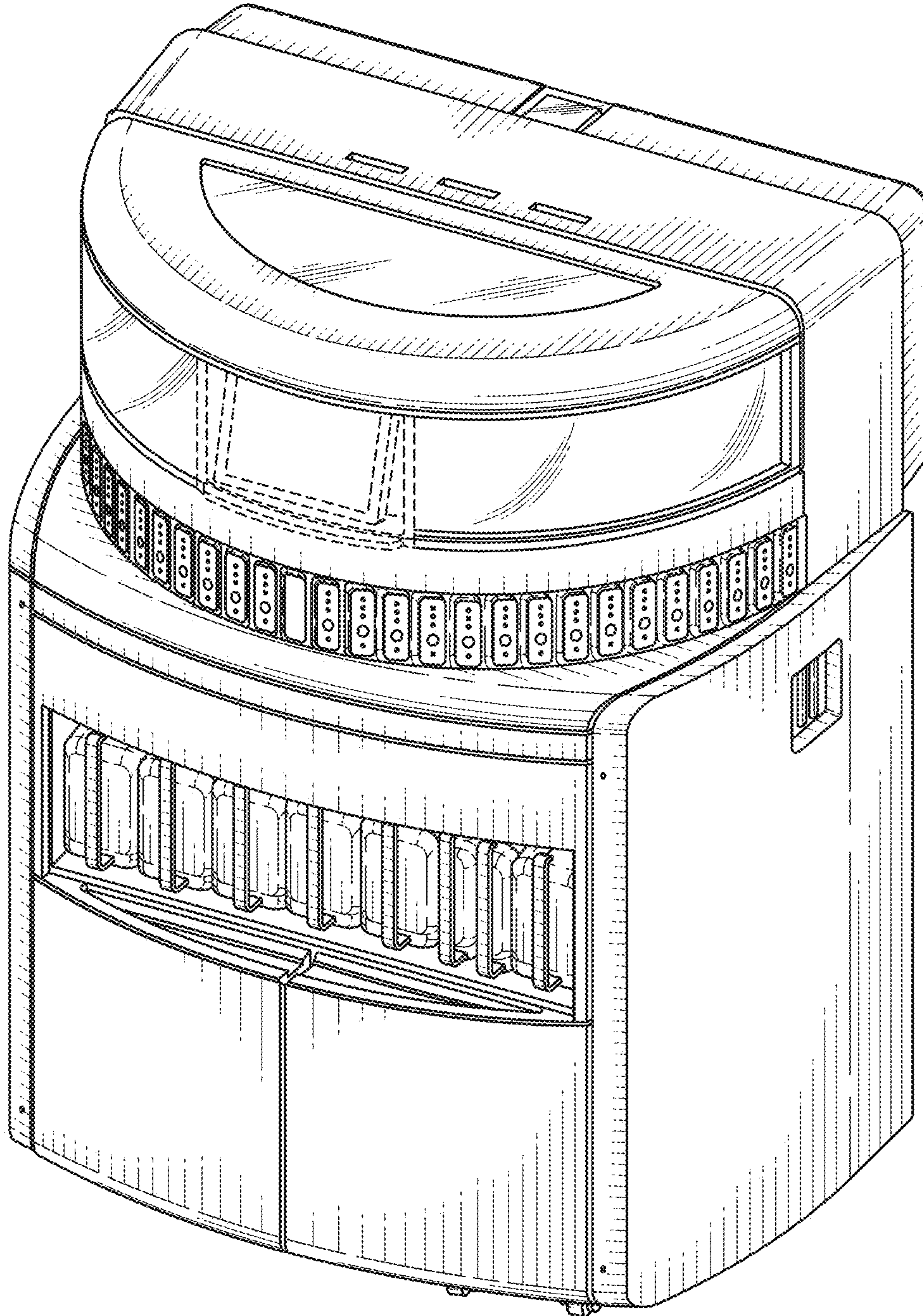

FIG. 2.1

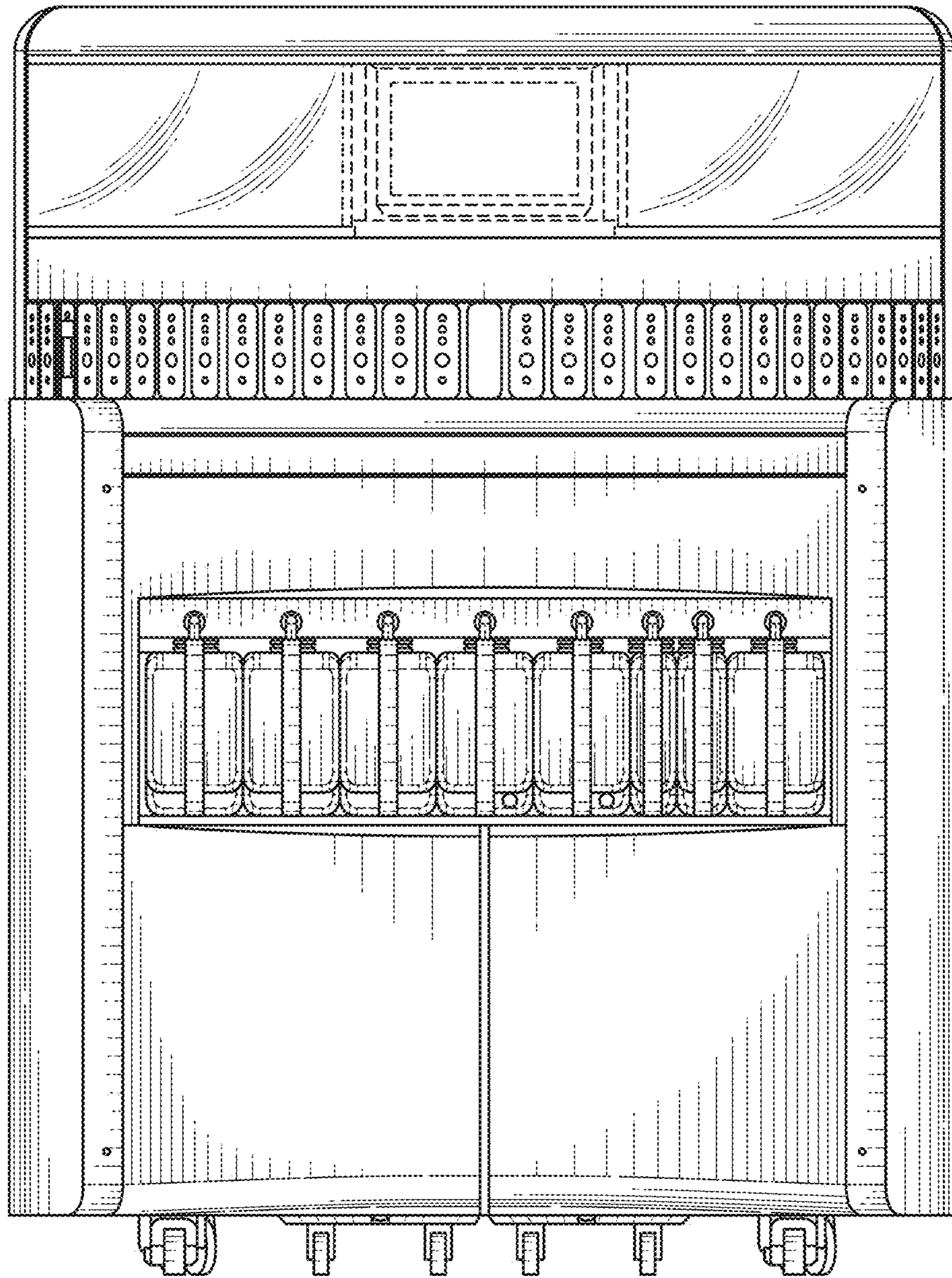

FIG. 2.2



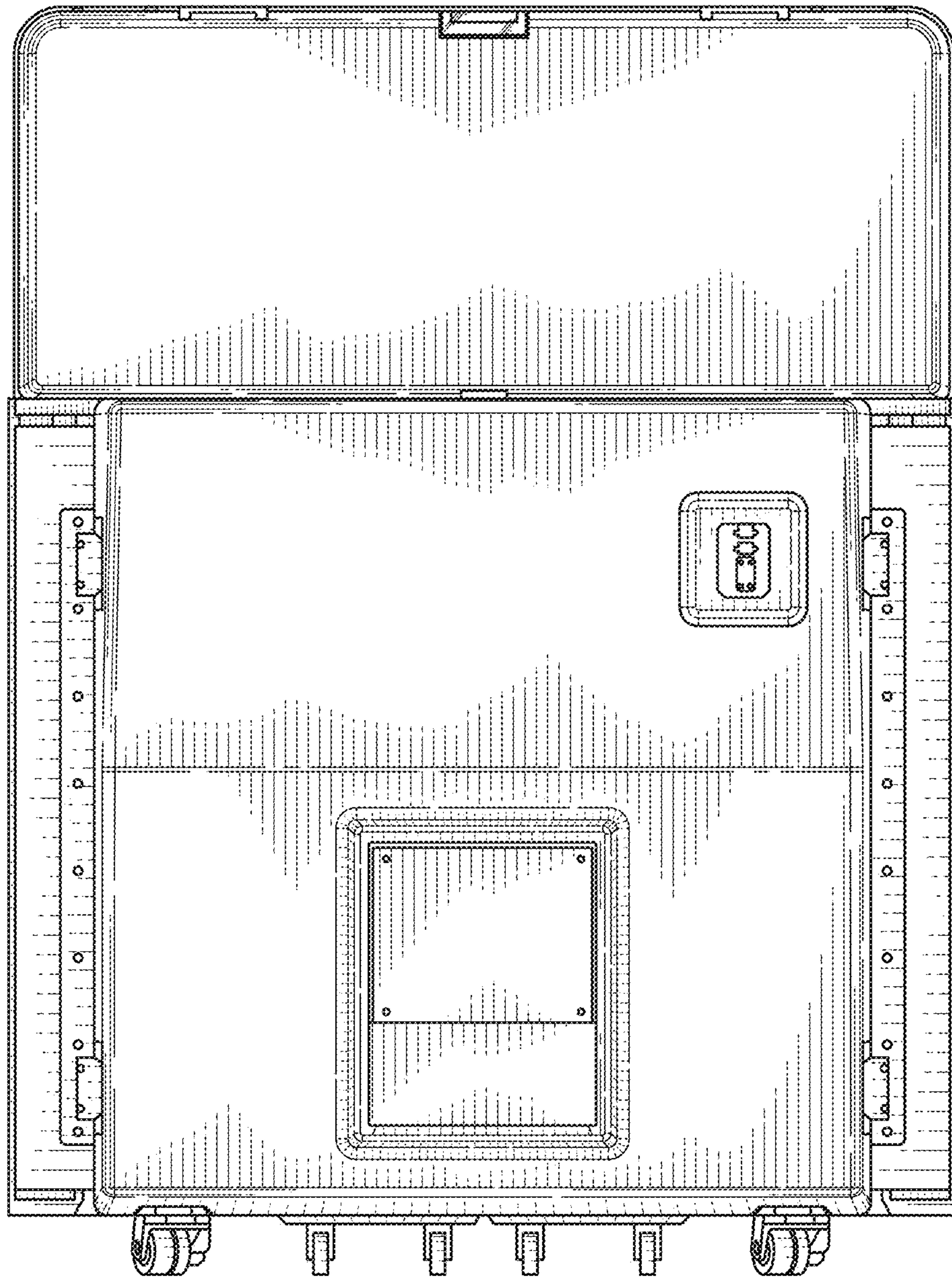

FIG. 23

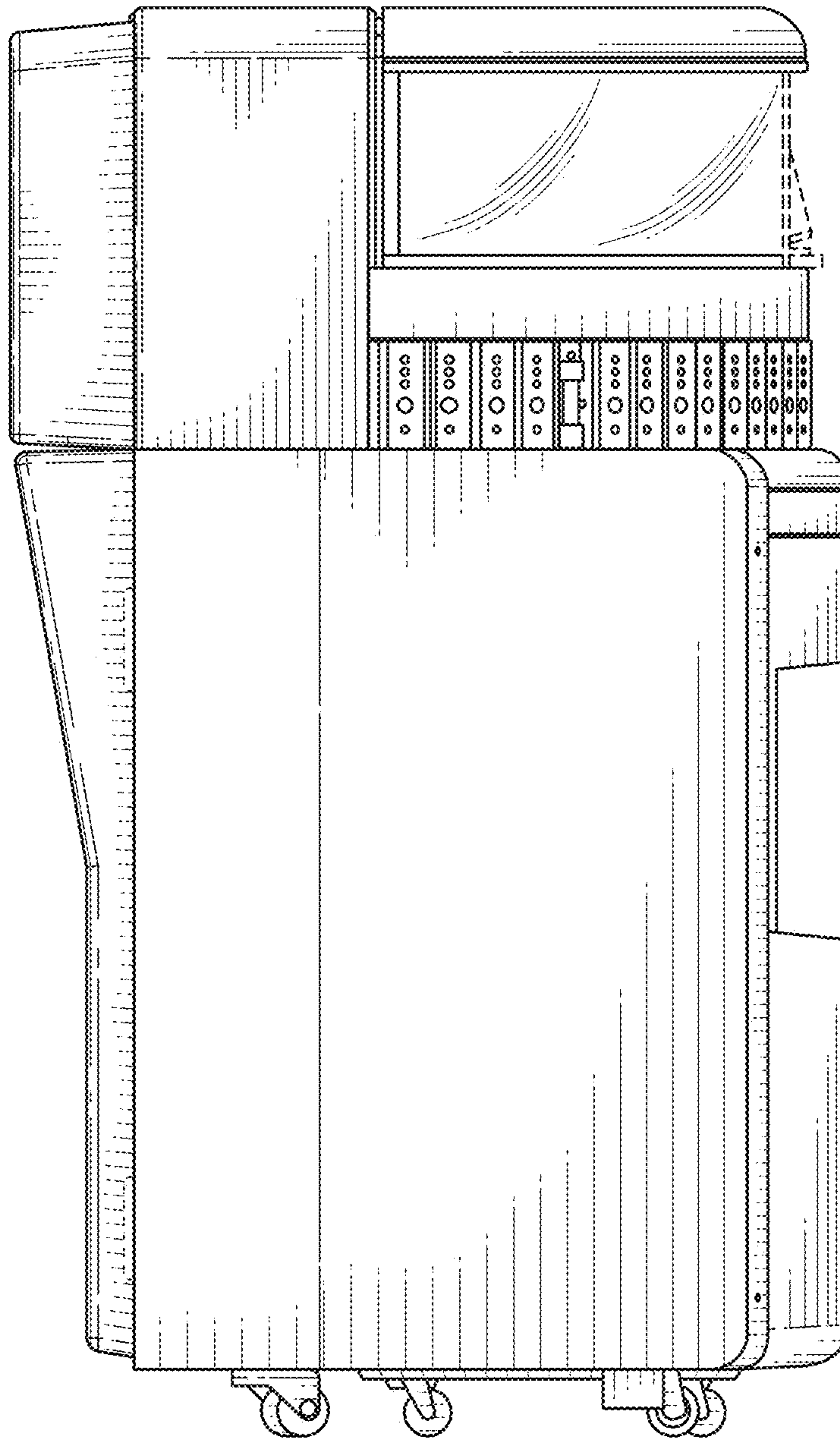

FIG. 2.4



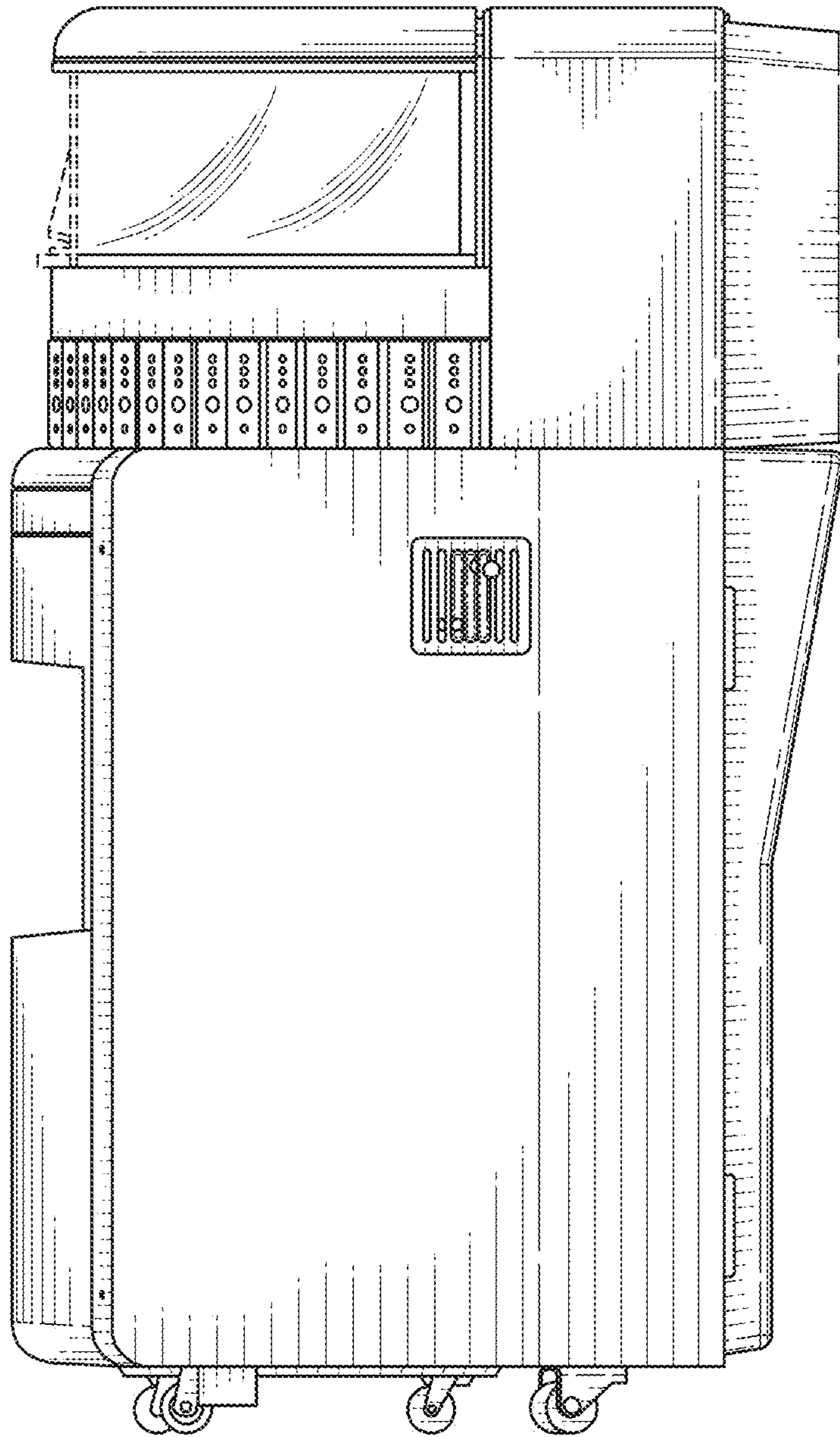

FIG. 2.5

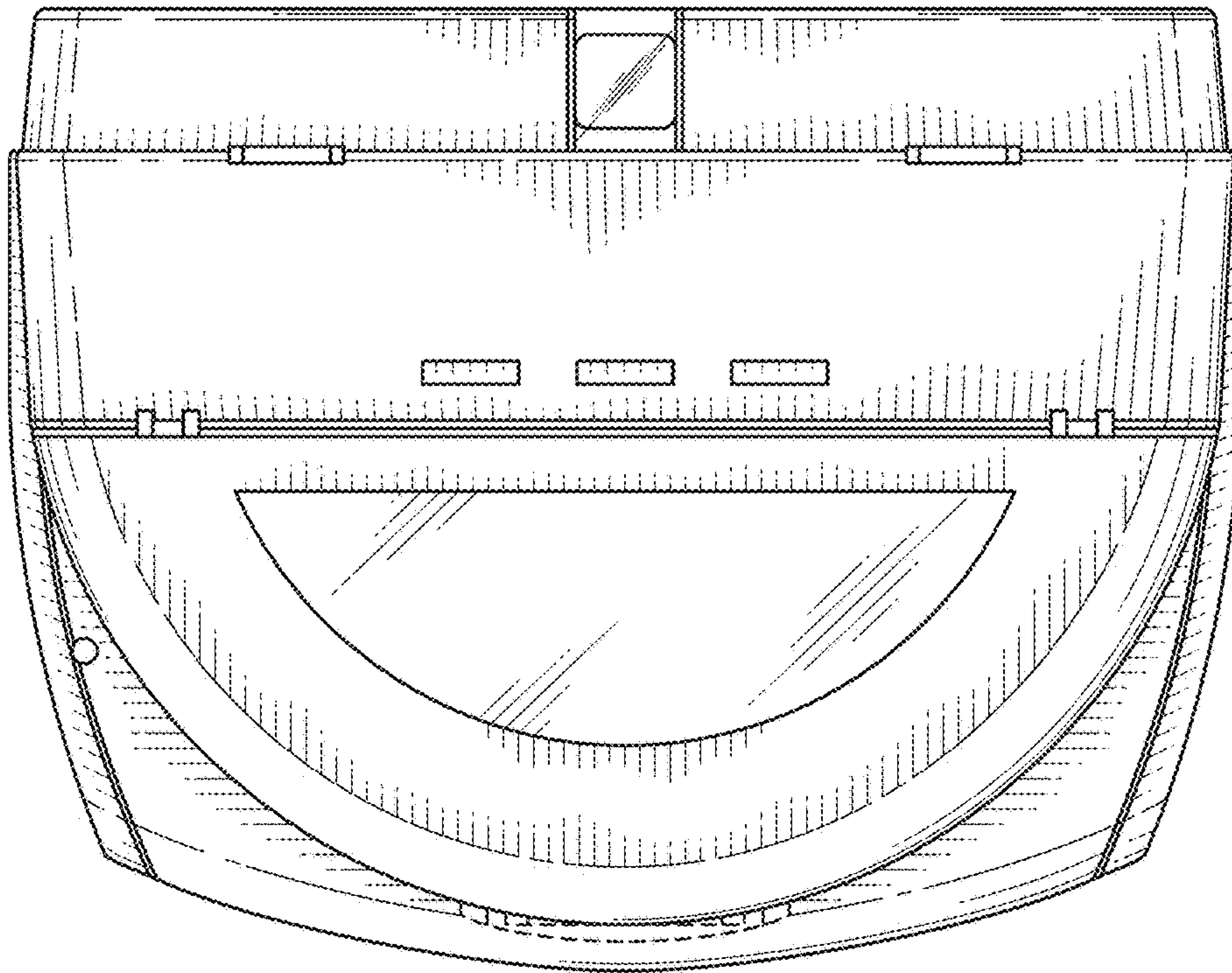

FIG. 2.6

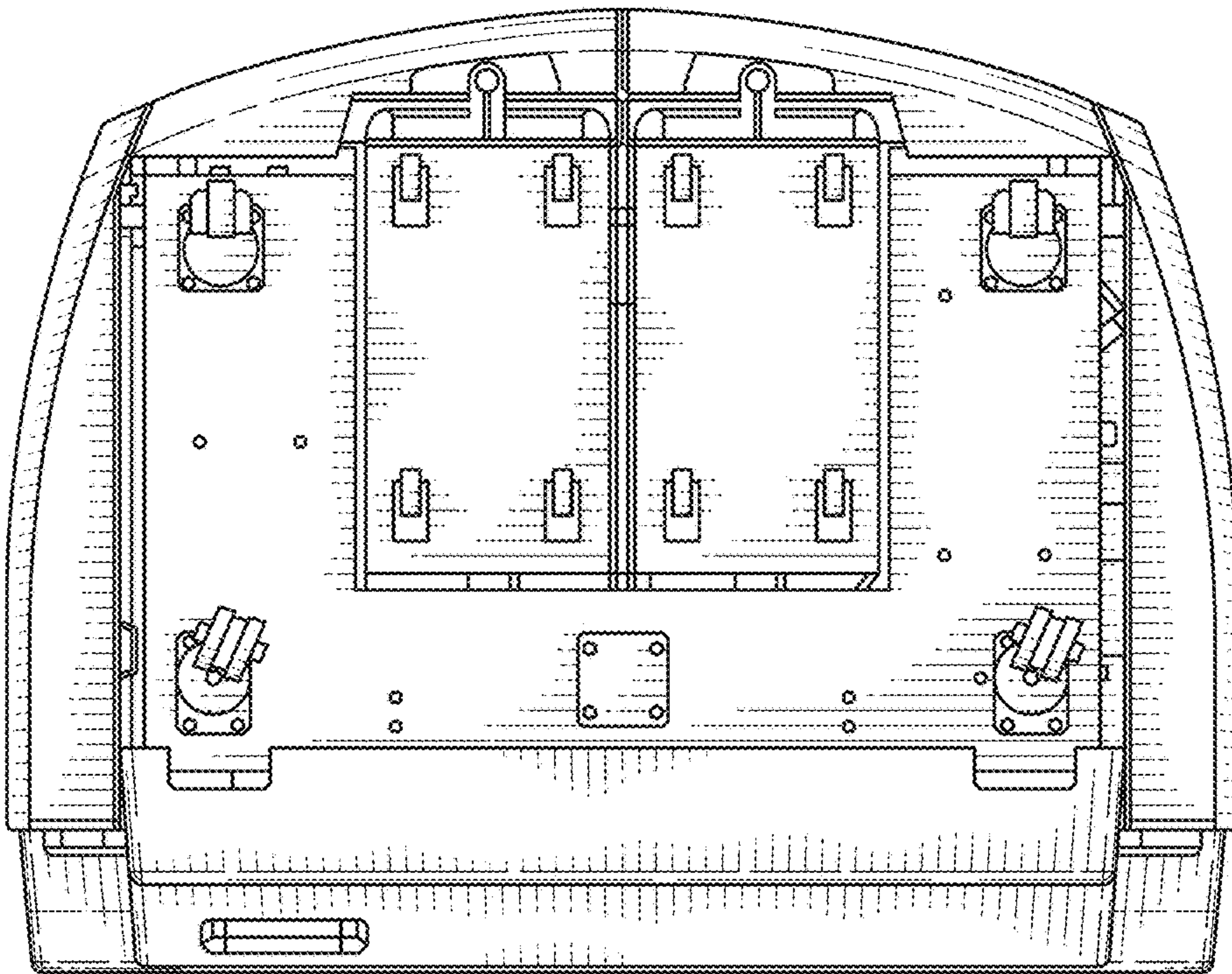

FIG. 2.7



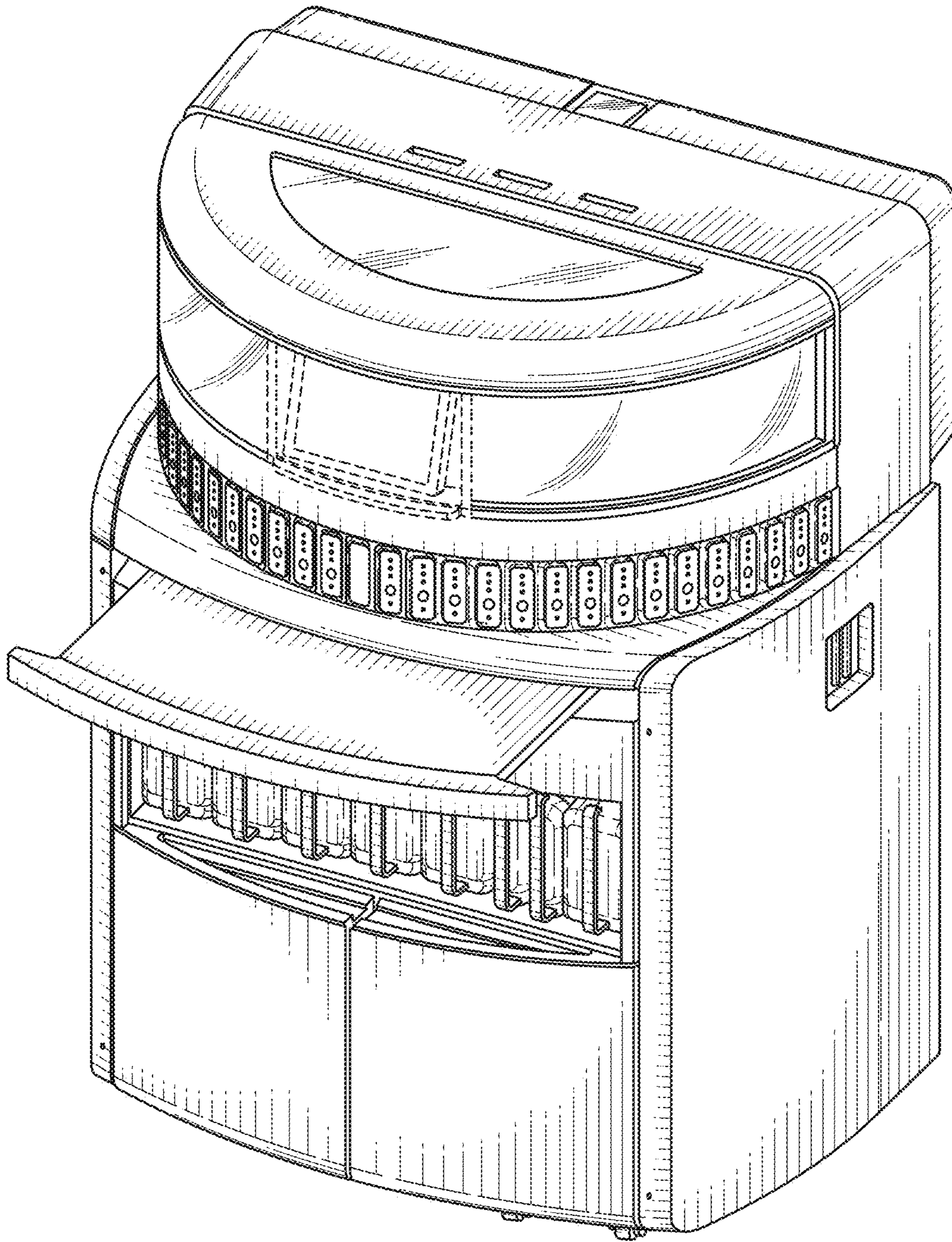

FIG. 2.8