



US00D872814S

(12) **United States Design Patent**
Cadiente

(10) **Patent No.:** **US D872,814 S**

(45) **Date of Patent:** **** Jan. 14, 2020**

(54) **TREE TOY**

(71) Applicant: **Jackie Cadiente**, Burbank, CA (US)

(72) Inventor: **Jackie Cadiente**, Burbank, CA (US)

(**) Term: **15 Years**

(21) Appl. No.: **29/670,940**

(22) Filed: **Nov. 20, 2018**

Related U.S. Application Data

(63) Continuation of application No. 29/658,047, filed on Jul. 27, 2018.

(51) **LOC (12) Cl.** **21-01**

(52) **U.S. Cl.**
USPC **D21/621**

(58) **Field of Classification Search**
USPC D21/621, 622, 630, 658, 659, 660, 661
CPC A63H 3/00
See application file for complete search history.

(56) **References Cited**

U.S. PATENT DOCUMENTS

D349,727 S * 8/1994 Burns D19/59
D501,898 S * 2/2005 Rutherford D21/623

D546,906 S * 7/2007 Aliaga D21/590
D566,796 S * 4/2008 Feeney D21/576
D714,888 S * 10/2014 Kasznica A63H 3/00
D21/630
D771,758 S * 11/2016 Arzoomanian D21/630
D807,590 S * 1/2018 Wills D30/160
D807,591 S * 1/2018 Wills D30/160
D821,662 S * 6/2018 Wills D30/160

* cited by examiner

Primary Examiner — Zenia I Bennett

(74) *Attorney, Agent, or Firm* — LKP Global Law, LLP

(57) **CLAIM**

The ornamental design for a tree toy, as shown and described.

DESCRIPTION

FIG. 1 is a top perspective view of a tree toy;
FIG. 2 is a front view of the tree toy of FIG. 1;
FIG. 3 is a rear view of a tree toy of FIG. 1;
FIG. 4 is a left view of the tree toy of FIG. 1;
FIG. 5 is a right view of a tree toy;
FIG. 6 is a top view of the tree toy of FIG. 1; and,
FIG. 7 is a bottom view of a tree toy.

1 Claim, 6 Drawing Sheets

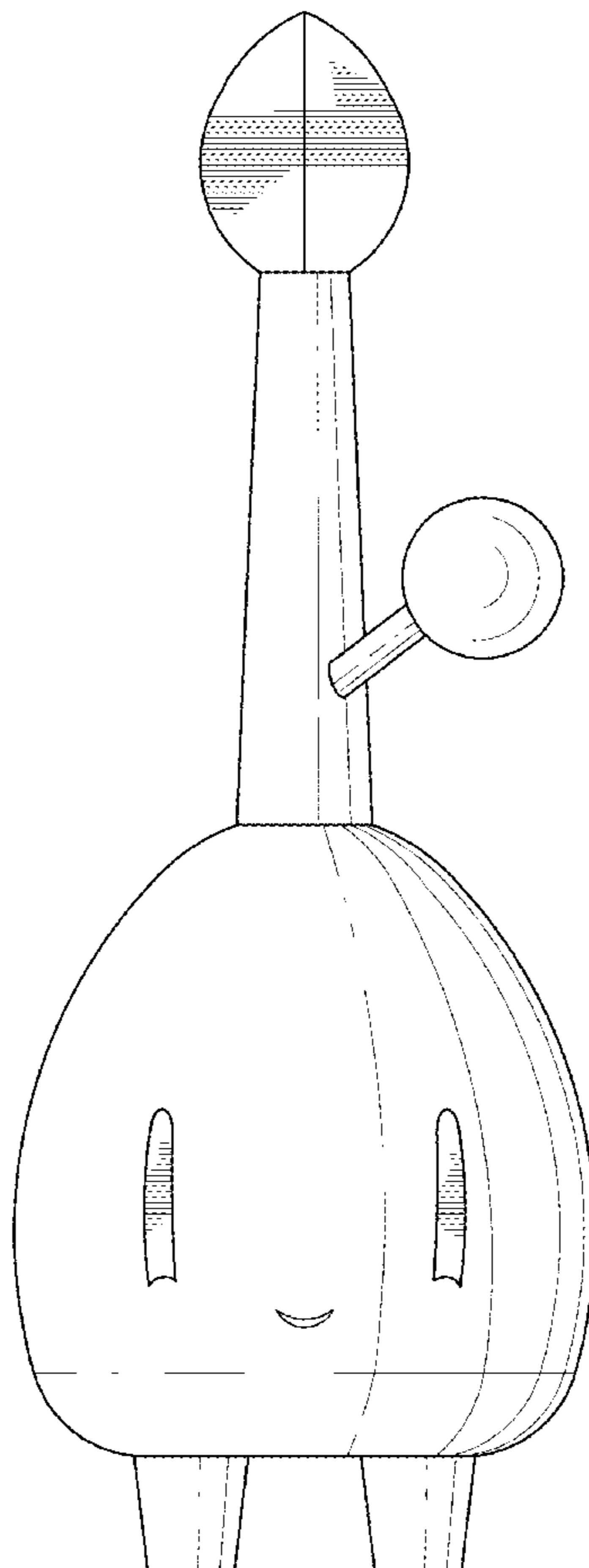

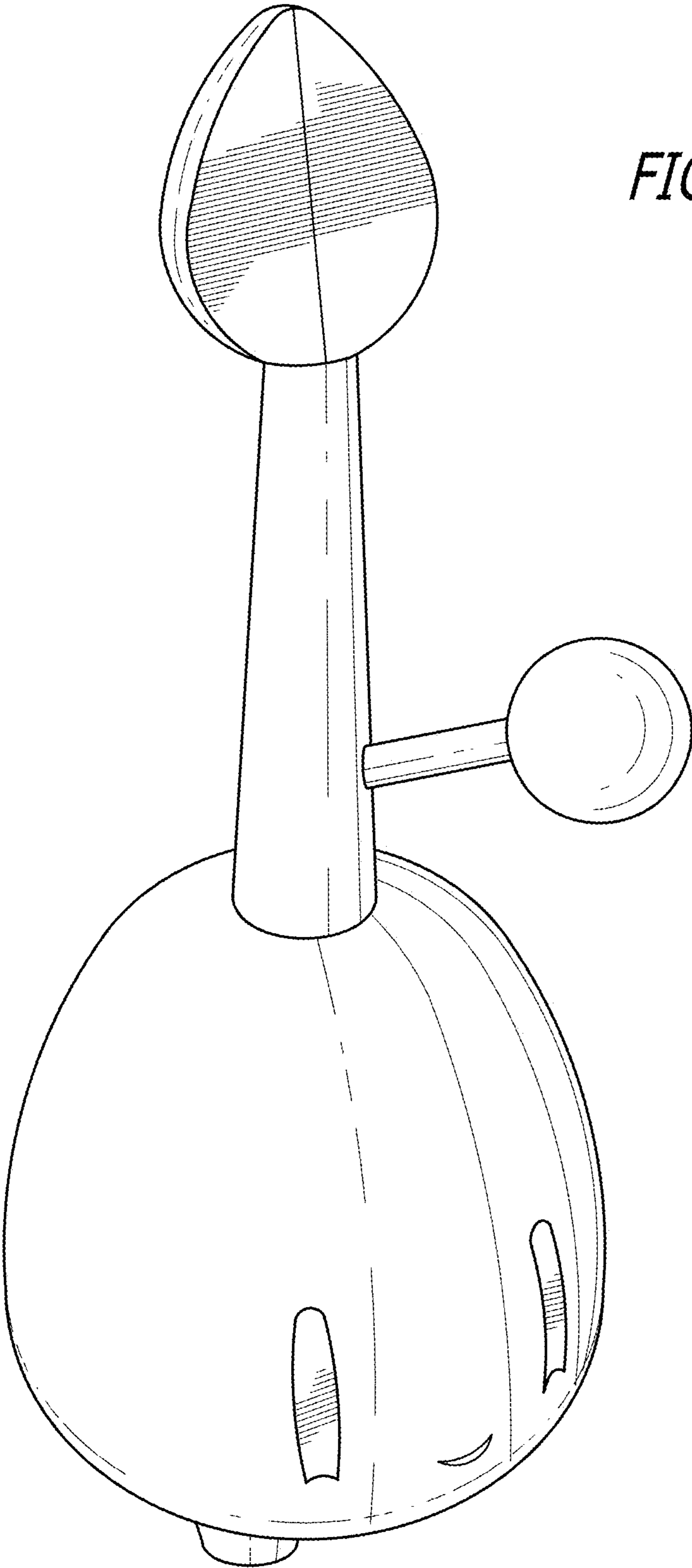

FIG. 1

FIG. 2

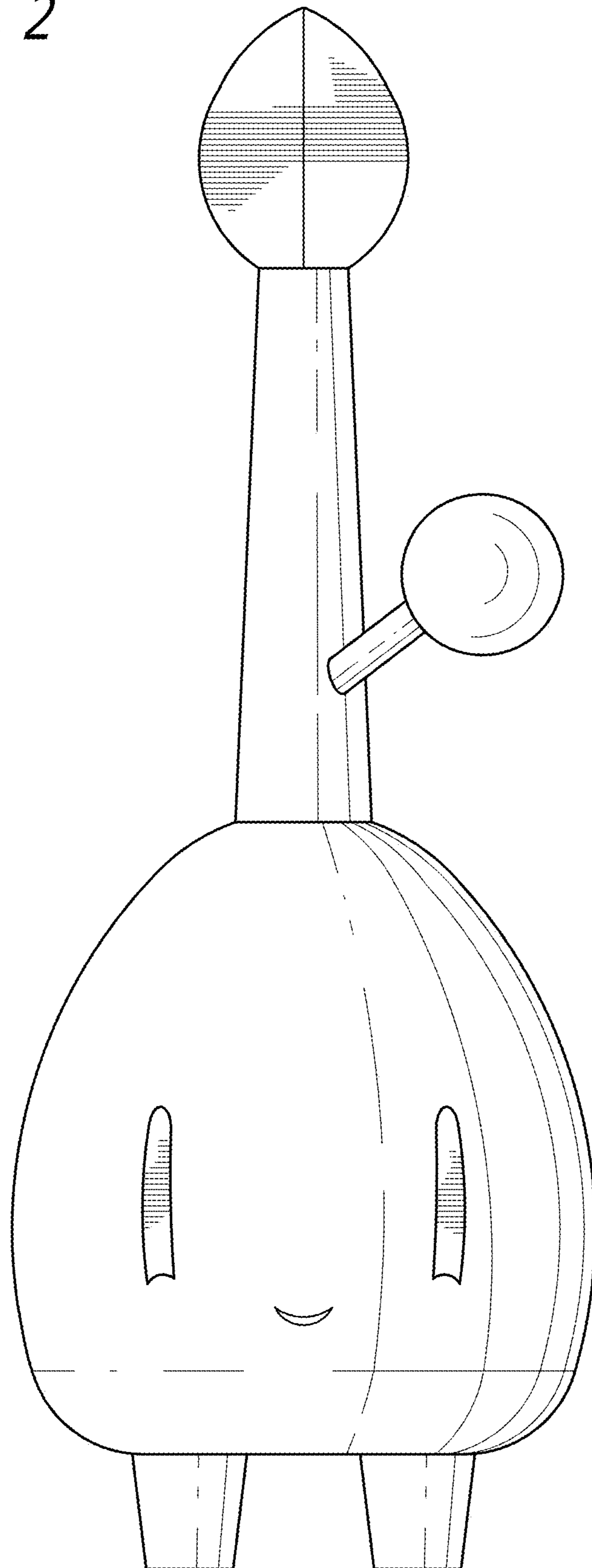

FIG. 3

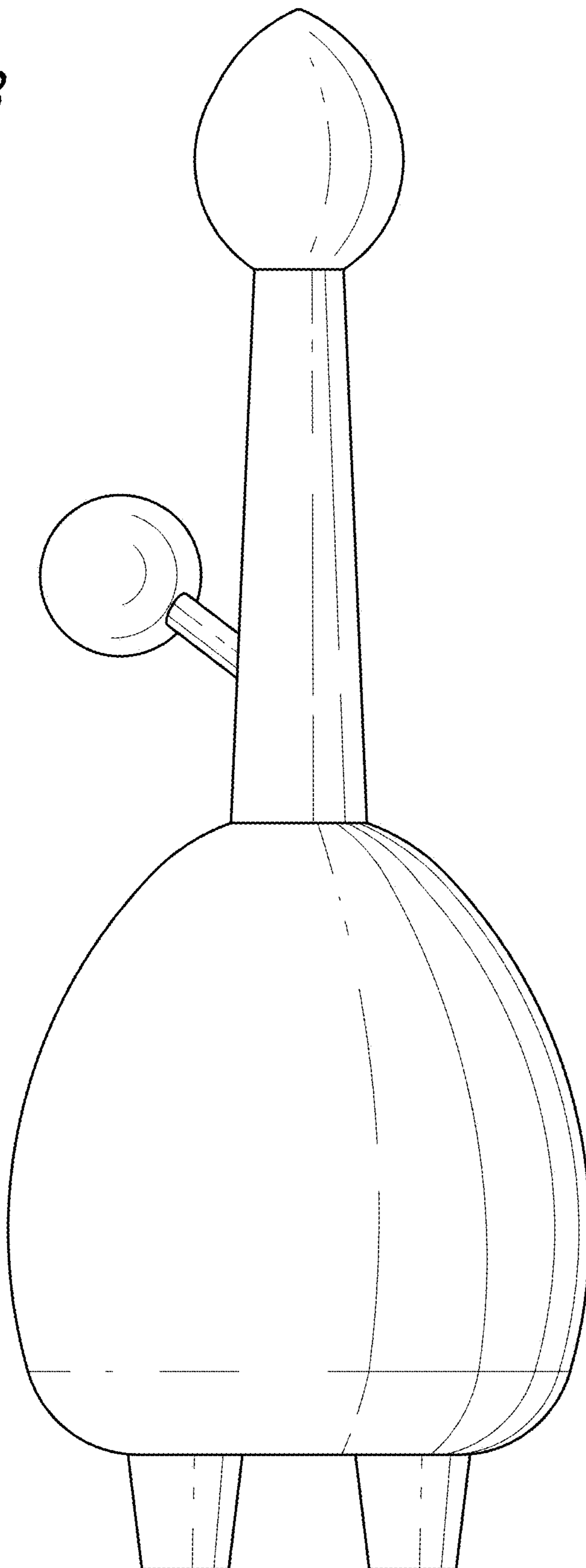

FIG. 4

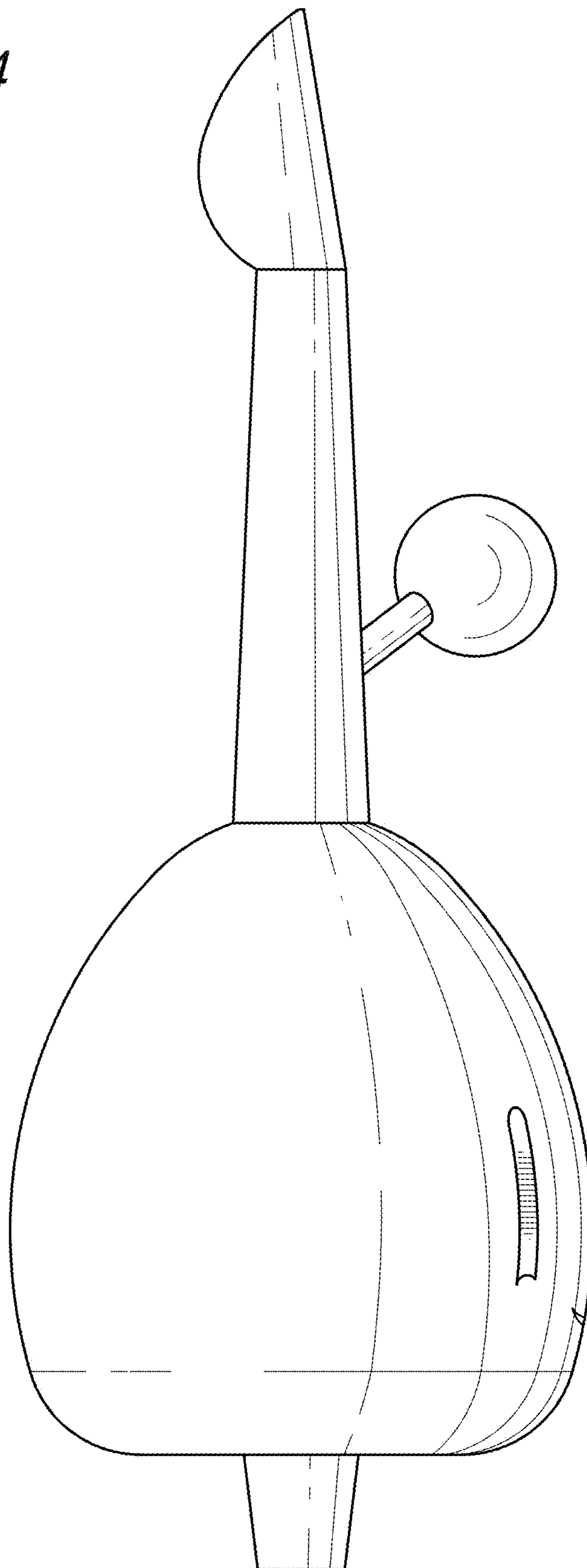

FIG. 5

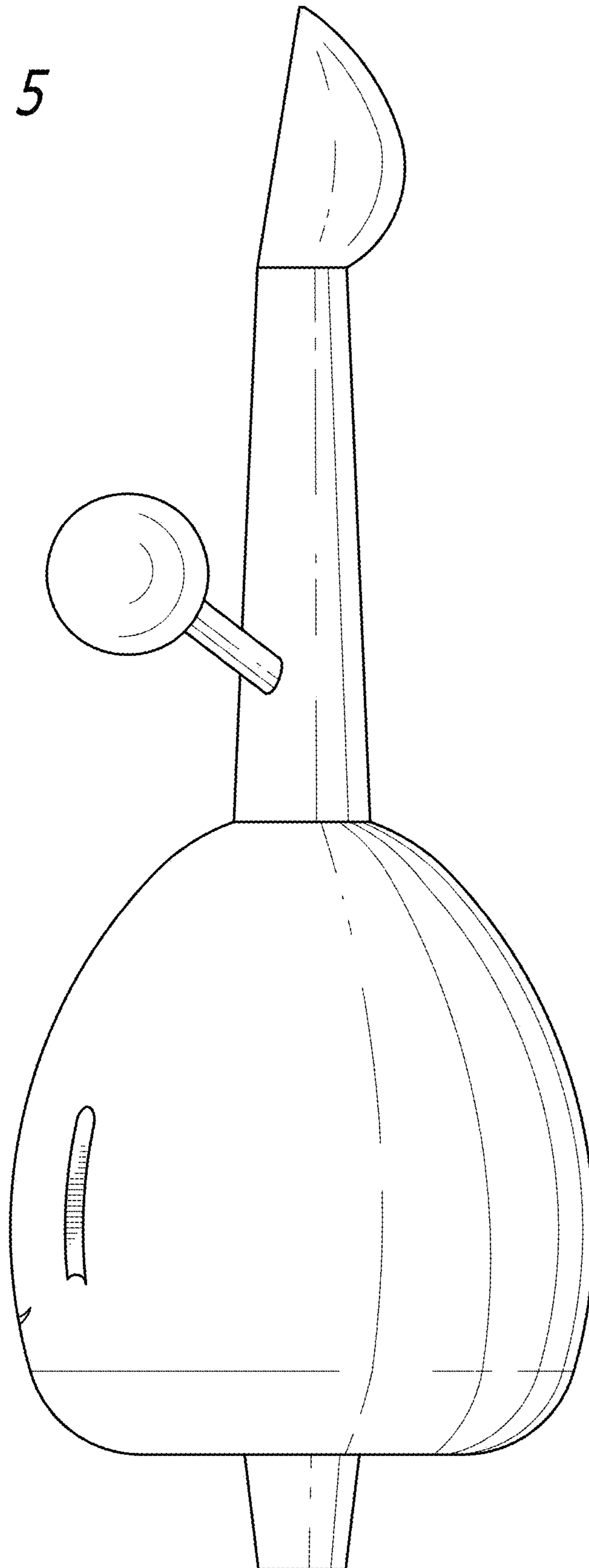

FIG. 6

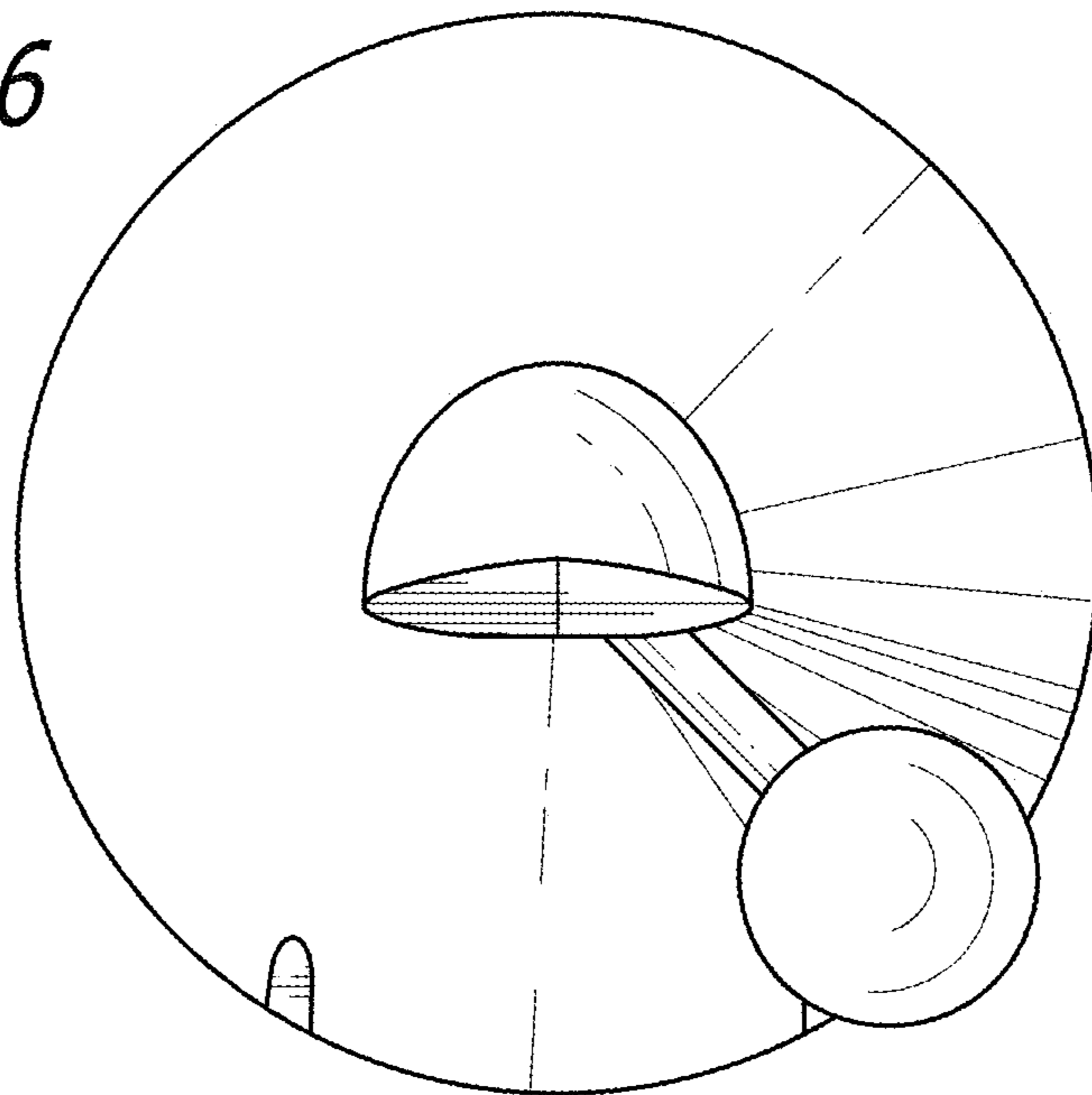

FIG. 7

