



US00D872774S

(12) **United States Design Patent** (10) **Patent No.:** **US D872,774 S**
Yu et al. (45) **Date of Patent:** **** Jan. 14, 2020**

(54) **REFRIGERATOR**

2317/041; F25D 2317/04131; F25D
2317/043; F25D 2317/0664; F25D

(71) Applicant: **LG ELECTRONICS INC.**, Seoul
(KR)

2321/147; F25D 2323/02; F25D 2323/023
See application file for complete search history.

(72) Inventors: **Seonil Yu**, Seoul (KR); **Kyutae Park**,
Seoul (KR); **Daesung Lee**, Seoul (KR);
Hyun Choi, Seoul (KR); **Junyi Heo**,
Seoul (KR)

(56) **References Cited**

U.S. PATENT DOCUMENTS

(73) Assignee: **LG ELECTRONICS INC.**, Seoul
(KR)

D615,565 S *	5/2010	Kristiansen	D15/86
D629,022 S *	12/2010	Cho	D15/85
D656,967 S *	4/2012	Yi	D15/86
D673,189 S *	12/2012	Kwak	D15/86
D681,075 S *	4/2013	Yi	D15/86
D691,644 S *	10/2013	Cho	D15/86
D701,539 S *	3/2014	Saejin	D15/85
D702,739 S *	4/2014	Kim	D15/86
D724,629 S *	3/2015	Choi	D15/85
D729,286 S *	5/2015	Kwak	D15/85
D732,584 S *	6/2015	Sin	D15/86
D742,434 S *	11/2015	Yeo	D15/86
D767,648 S *	9/2016	Shoemaker	D15/86
D826,998 S *	8/2018	Lee	D15/91

(**) Term: **15 Years**

(21) Appl. No.: **35/505,303**

(22) Filed: **Jan. 12, 2018**

(80) **Hague Agreement Data**

Int. Filing Date: **Jan. 12, 2018**
Int. Reg. No.: **DM/100736**
Int. Reg. Date: **Jan. 12, 2018**
Int. Reg. Pub. Date: **Jul. 13, 2018**

* cited by examiner

Primary Examiner — Richard E Chilcot

(74) *Attorney, Agent, or Firm* — Birch, Stewart, Kolasch
& Birch, LLP

(30) **Foreign Application Priority Data**

Jul. 14, 2017 (KR) 30-2017-0032697

(51) **LOC (12) Cl.** **15-07**

(52) **U.S. Cl.**
USPC **D15/86**
CPC **F25D 23/025** (2013.01)

(58) **Field of Classification Search**
USPC D15/79-91
CPC F25D 23/025; F25D 23/028; F25D
2323/024; F25D 23/00; F25D 23/02;
F25D 2323/021; F25D 23/065; F25D
11/00; F25D 2201/14; F25D 23/021;
F25D 23/04; F25D 27/00; F25D 23/062;
F25D 23/067; F25D 2400/18; F25D
23/08; F25D 23/085; F25D 2500/02;
F25D 25/00; F25D 25/005; F25D 25/022;
F25D 25/024; F25D 17/047; F25D

(57) **CLAIM**

The ornamental design for a refrigerator, as shown and
described.

DESCRIPTION

- 1. Refrigerator
- 1.1 : Perspective
- 1.2 : Front
- 1.3 : Back
- 1.4 : Left
- 1.5 : Right
- 1.6 : Top
- 1.7 : Bottom

(Continued)

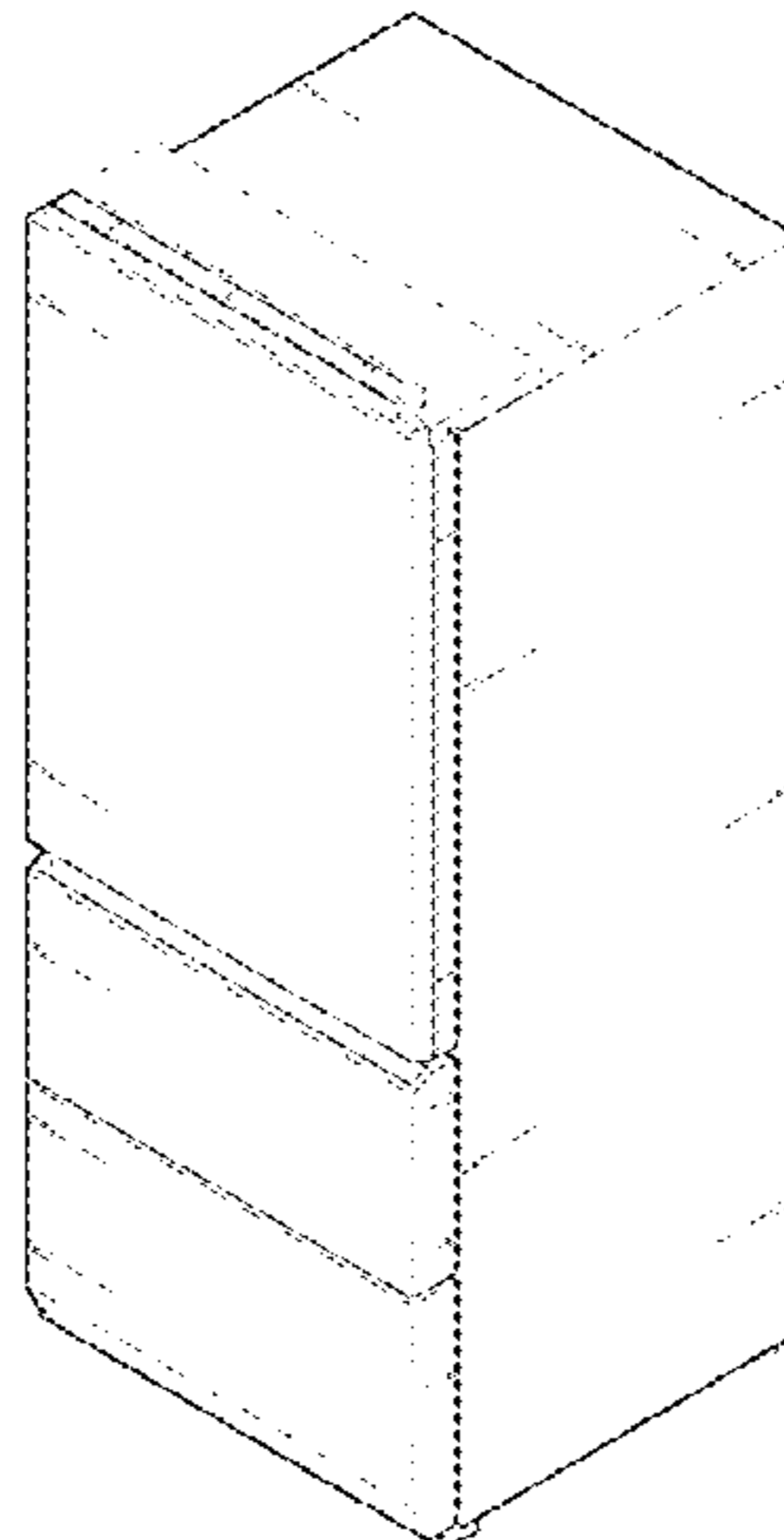

The broken lines depict portions of the refrigerator that form no part of the claimed design.

1 Claim, 7 Drawing Sheets

1.1

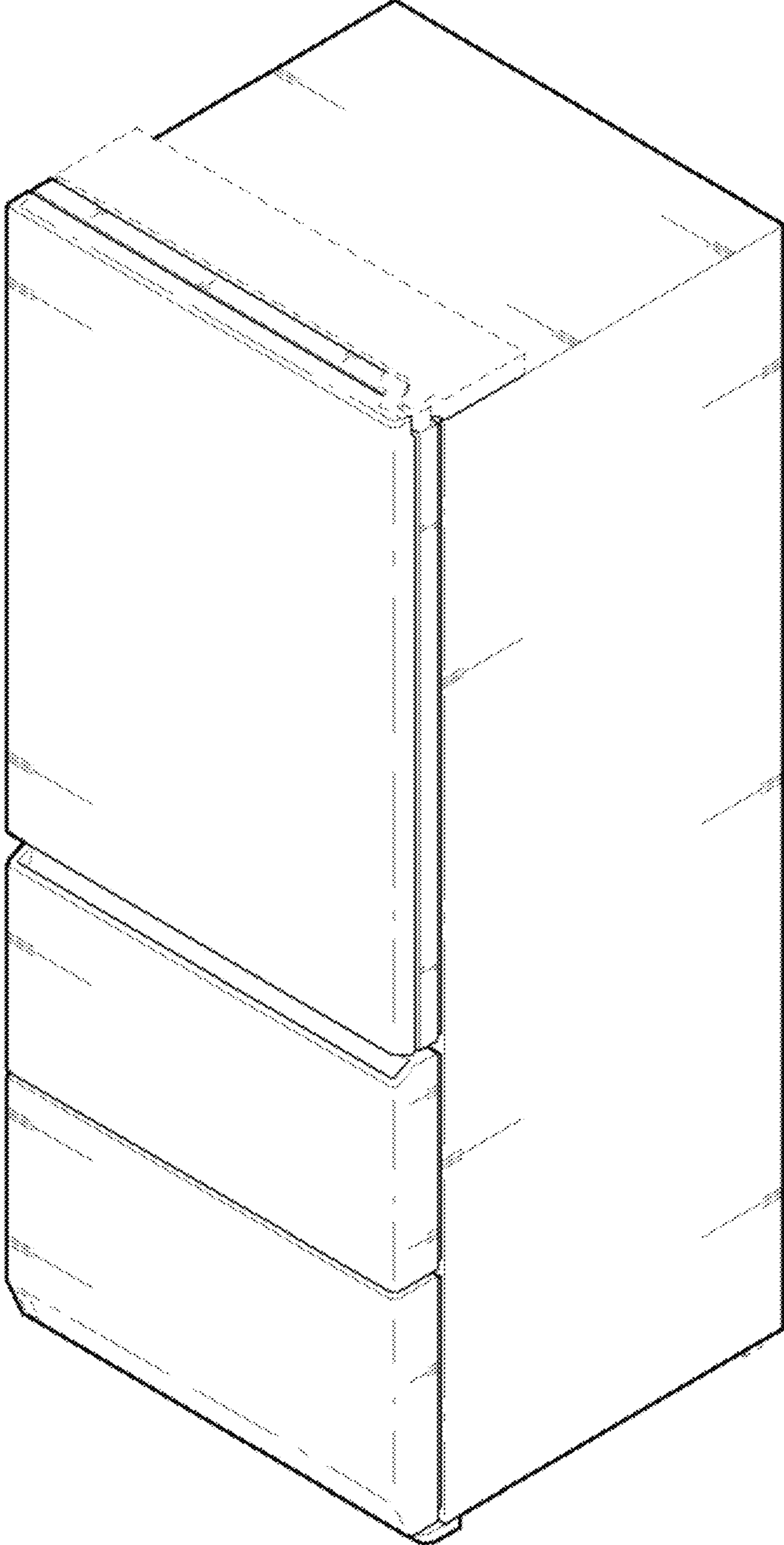

1.2

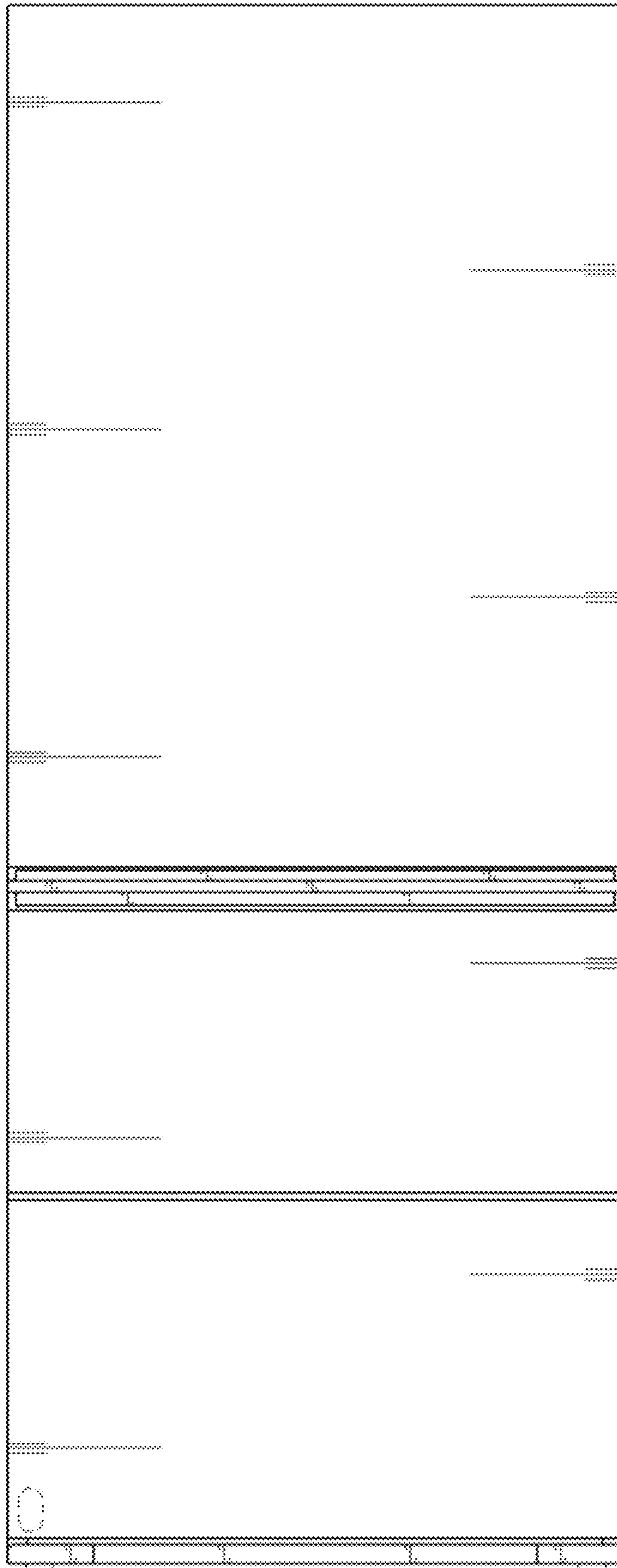

1.3

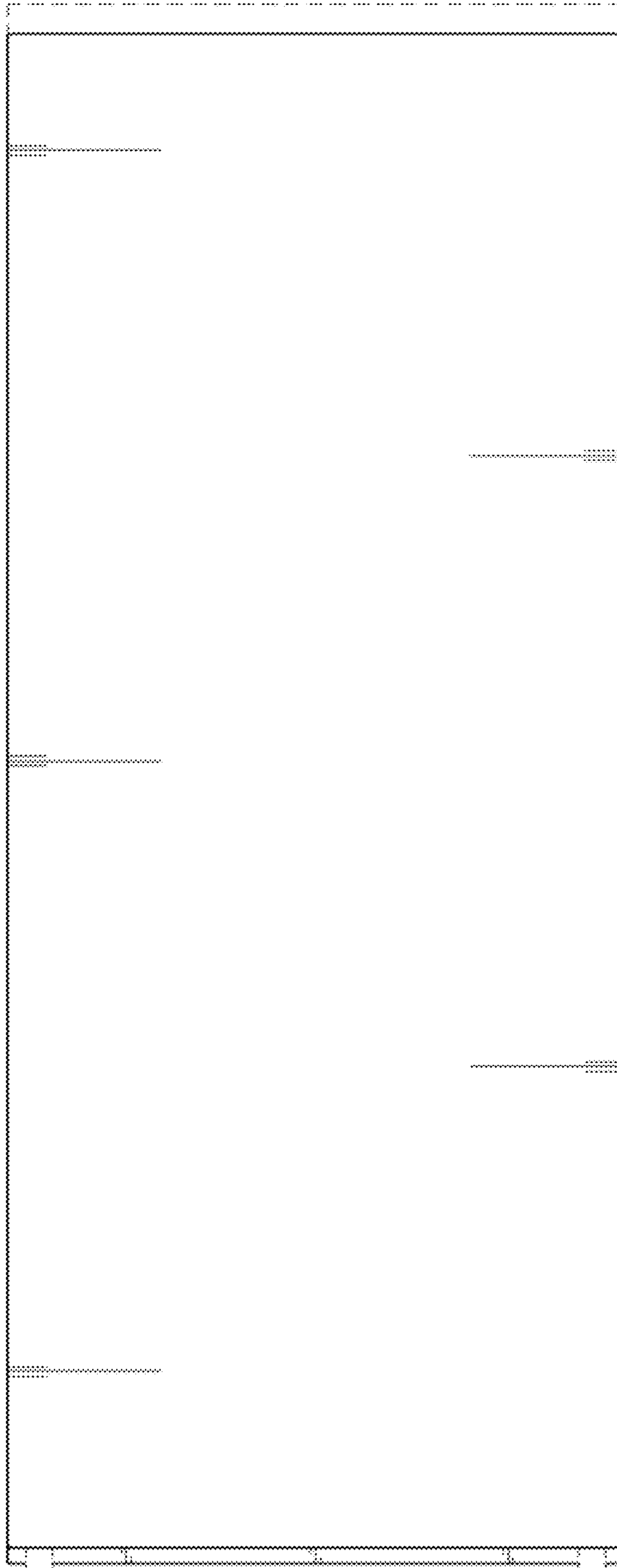

1.4

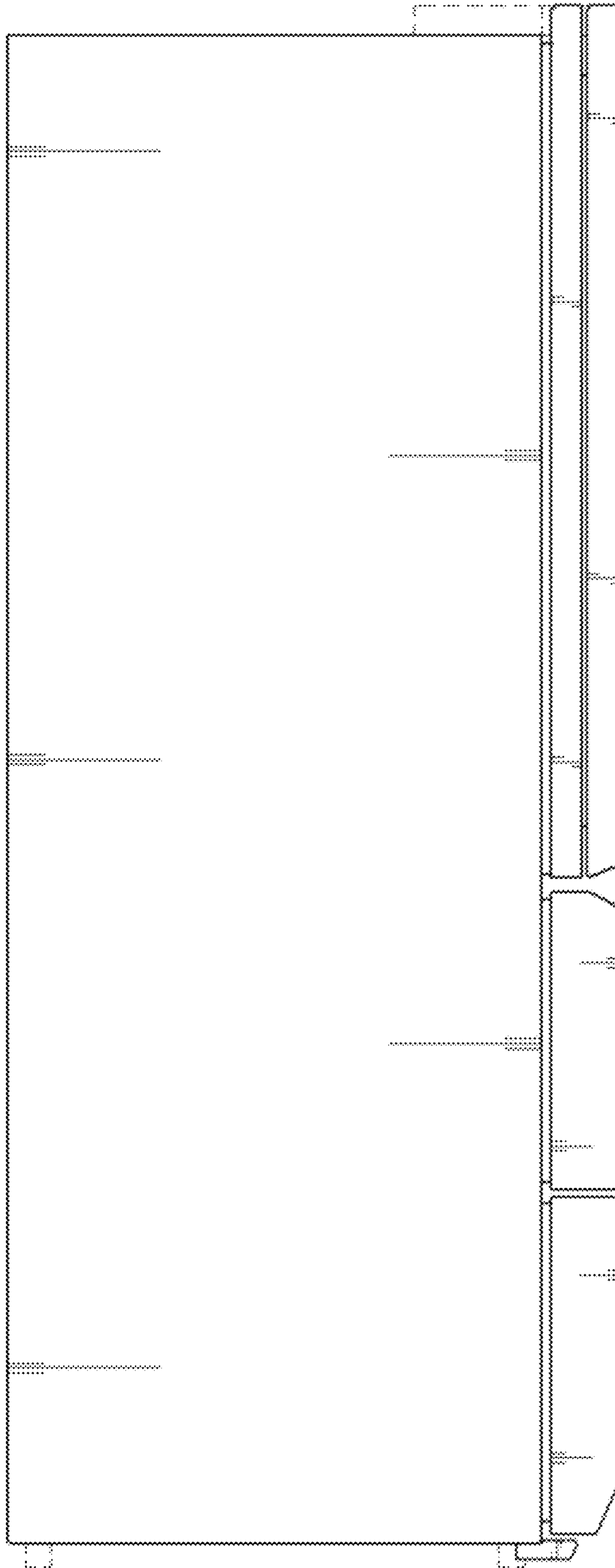

1.5

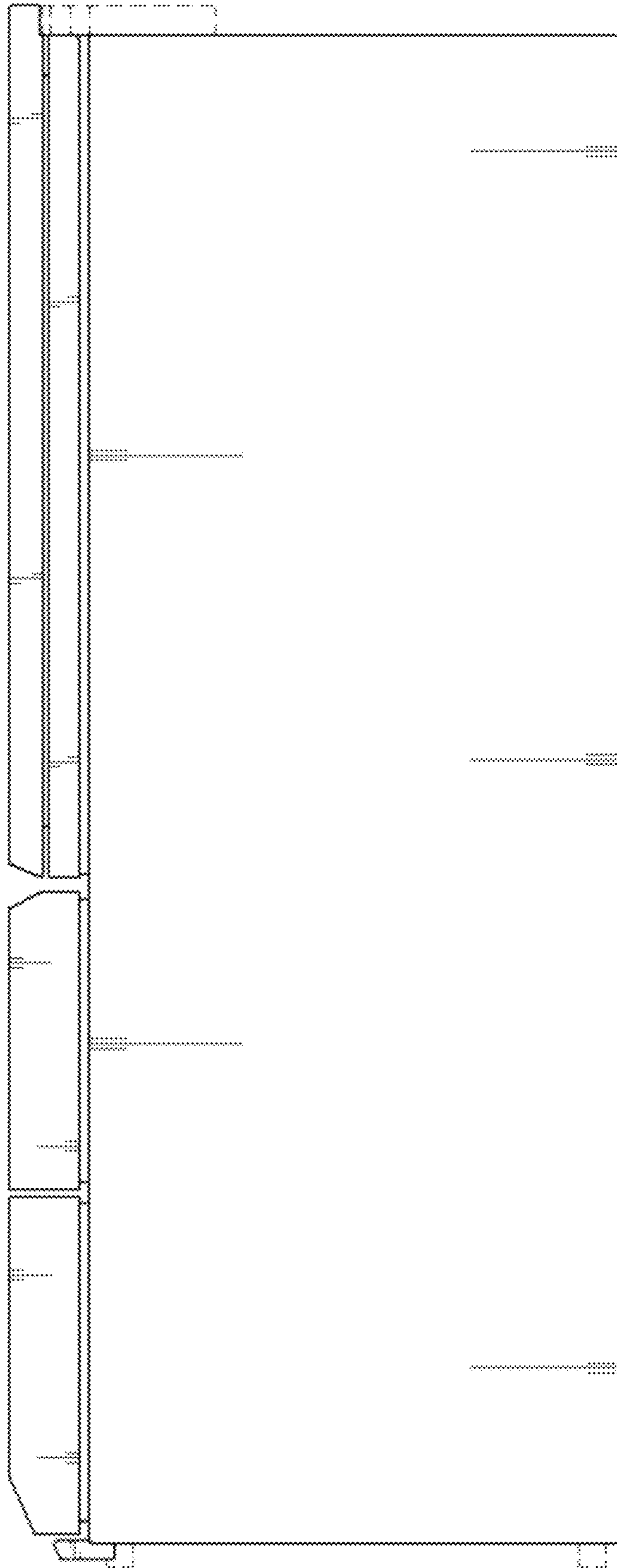

1.6

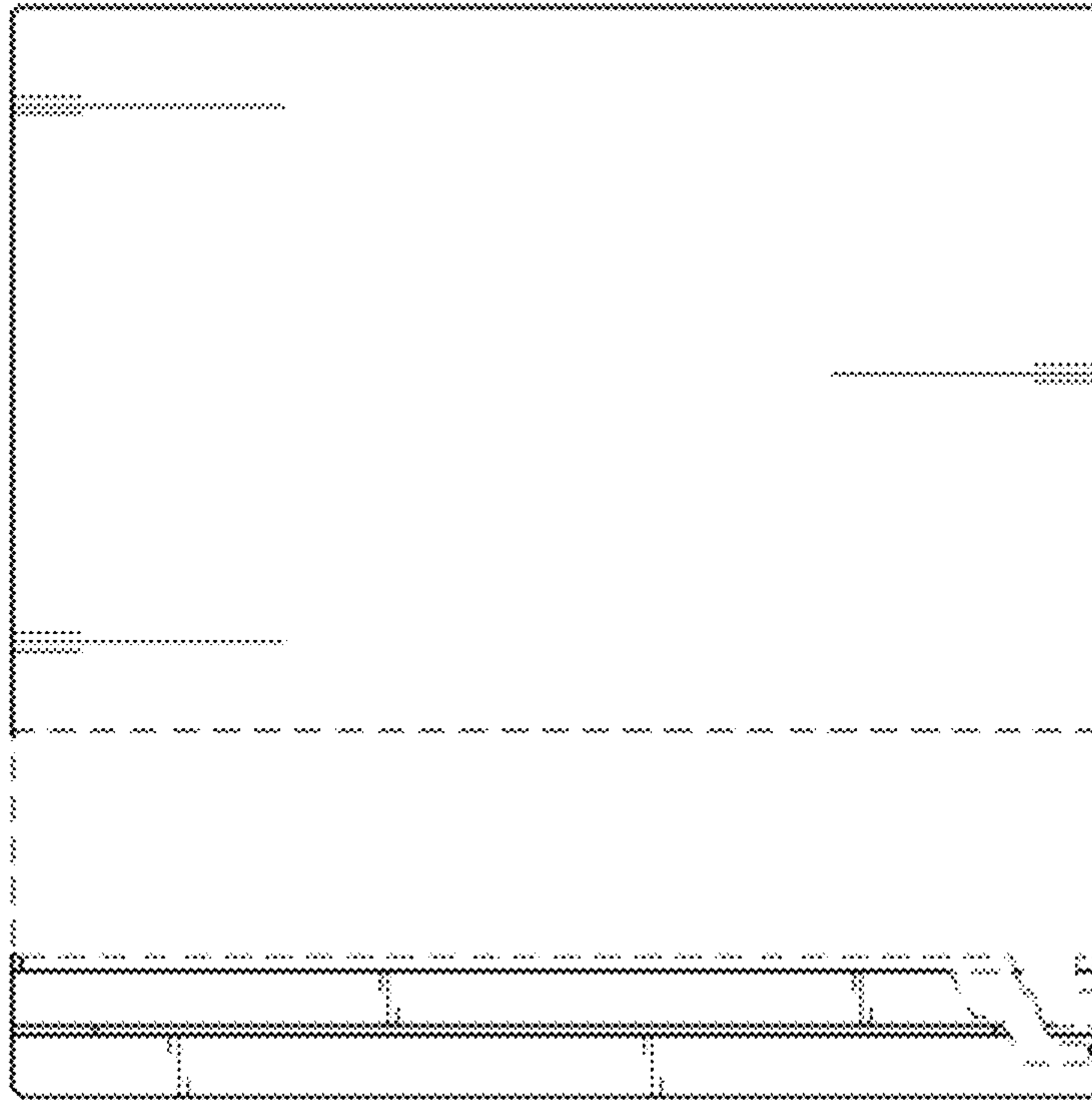

1.7

