



US00D872737S

(12) **United States Design Patent**  
**Ressel et al.**

(10) **Patent No.:** **US D872,737 S**  
(45) **Date of Patent:** **\*\* Jan. 14, 2020**

(54) **DISPLAY DEVICE WITH GRAPHICAL USER INTERFACE HAVING A PROGRESS INDICATOR ANIMATION**

*Primary Examiner* — Nicole C Shiflet  
(74) *Attorney, Agent, or Firm* — Ferguson Braswell  
Fraser Kubasta PC

(71) Applicants: **Dawn Ressel**, Poway, CA (US);  
**Xiaonan Wang**, San Diego, CA (US);  
**Eric Knudtson**, Palo Alto, CA (US);  
**Nathan Bailey**, Dallas, TX (US);  
**Bobby Bray**, San Diego, CA (US);  
**Meghan Cartlidge**, San Diego, CA (US);  
**Heather Daggett**, Bend, OR (US);  
**Michael D. Dulin**, Mountain View, CA (US)

(57) **CLAIM**

The ornamental design for a display device with graphical user interface having a progress indicator animation, as shown and described.

(72) Inventors: **Dawn Ressel**, Poway, CA (US);  
**Xiaonan Wang**, San Diego, CA (US);  
**Eric Knudtson**, Palo Alto, CA (US);  
**Nathan Bailey**, Dallas, TX (US);  
**Bobby Bray**, San Diego, CA (US);  
**Meghan Cartlidge**, San Diego, CA (US);  
**Heather Daggett**, Bend, OR (US);  
**Michael D. Dulin**, Mountain View, CA (US)

**DESCRIPTION**

FIG. 1 is a front view of a first image of a display device with graphical user interface having a progress indicator animation according to the invention.  
FIG. 2 is a second image thereof.  
FIG. 3 is a third image thereof.  
FIG. 4 is a fourth image thereof.  
FIG. 5 is a fifth image thereof.  
FIG. 6 is a sixth image thereof.  
FIG. 7 is a seventh image thereof.  
FIG. 8 is an eighth image thereof.  
FIG. 9 is a ninth image thereof.  
FIG. 10 is a tenth image thereof.  
FIG. 11 is an eleventh image thereof.  
FIG. 12 is a twelfth image thereof.  
FIG. 13 is a thirteenth image thereof.  
FIG. 14 is a fourteenth image thereof.  
FIG. 15 is a fifteenth image thereof.  
FIG. 16 is a sixteenth image thereof; and,  
FIG. 17 is a seventeenth image thereof.

(73) Assignee: **Intuit Inc.**, Mountain View, CA (US)

(\*\*) Term: **15 Years**

(21) Appl. No.: **29/612,141**

(22) Filed: **Jul. 28, 2017**

(51) **LOC (12) Cl.** ..... **14-04**

(52) **U.S. Cl.**  
USPC ..... **D14/485**

(58) **Field of Classification Search**  
USPC ..... D14/485-495

(Continued)

(56) **References Cited**

**U.S. PATENT DOCUMENTS**

D752,072 S \* 3/2016 Song ..... D14/486  
D761,277 S \* 7/2016 Harvell ..... D14/485

(Continued)

The appearance of the transitional image sequentially transitions between the images shown in FIGS. 1, 2, 3, 4, 5, 6, 7, 8, 9, 10, 11, 12, 13, 14, 15, 16, and 17. The progress period in which one image transitions to another image forms no part of the claimed design.

The broken lines, showing of the electronic device and display screen, are for the purpose of illustrating environment and forms no part of the claimed design. The broken line showing of elements, including the icon in the middle of the circle on FIGS. 10-17, on the display screen forms no part of the claimed design.

(Continued)

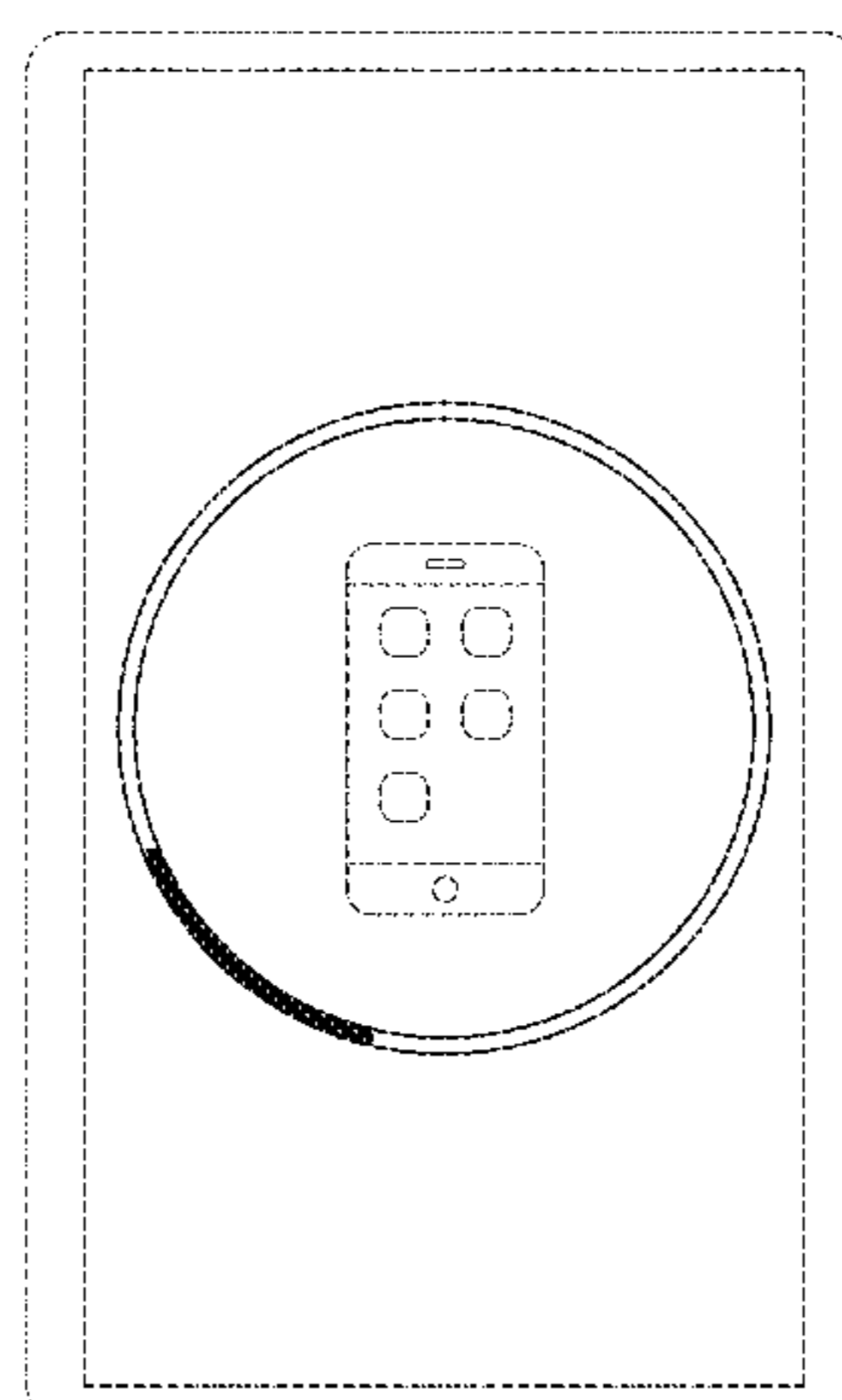
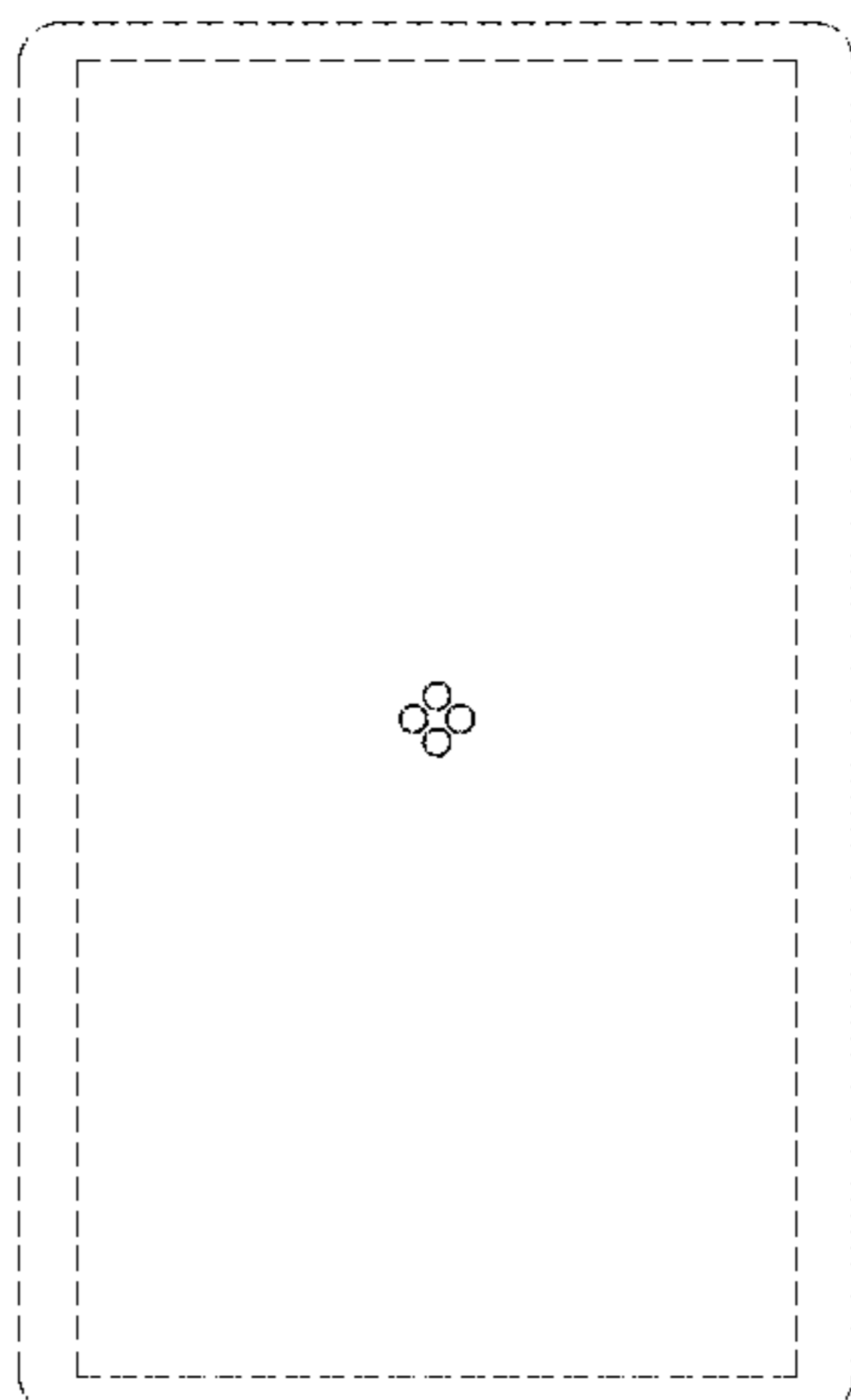

The appearance of FIGS. 1, 2, 3, 4, 5, 6, 7, 8, 9, 10, 11, 12, 13, 14, 15, 16, and 17 using black is to show color contrast.

**1 Claim, 9 Drawing Sheets**

**(58) Field of Classification Search**

CPC ..... G06F 3/048; G06F 3/0481; G06F 3/0482;  
G06F 3/04842; G06F 3/04817

See application file for complete search history.

**(56) References Cited**

U.S. PATENT DOCUMENTS

D763,309 S *	8/2016	Seo .....	D14/485
D764,493 S *	8/2016	Sanderson .....	D14/485
D777,735 S *	1/2017	Kim .....	D14/485
D785,658 S *	5/2017	Moroney .....	D14/486
D788,122 S *	5/2017	Tada .....	D14/485
D795,885 S *	8/2017	Pritchard .....	D14/485
D799,503 S *	10/2017	Kim .....	D14/485
D821,443 S *	6/2018	Jang .....	D14/489
D822,680 S *	7/2018	Loi .....	D14/485
D823,859 S *	7/2018	Boyd .....	D14/485
D832,886 S *	11/2018	Cros .....	D14/489

\* cited by examiner

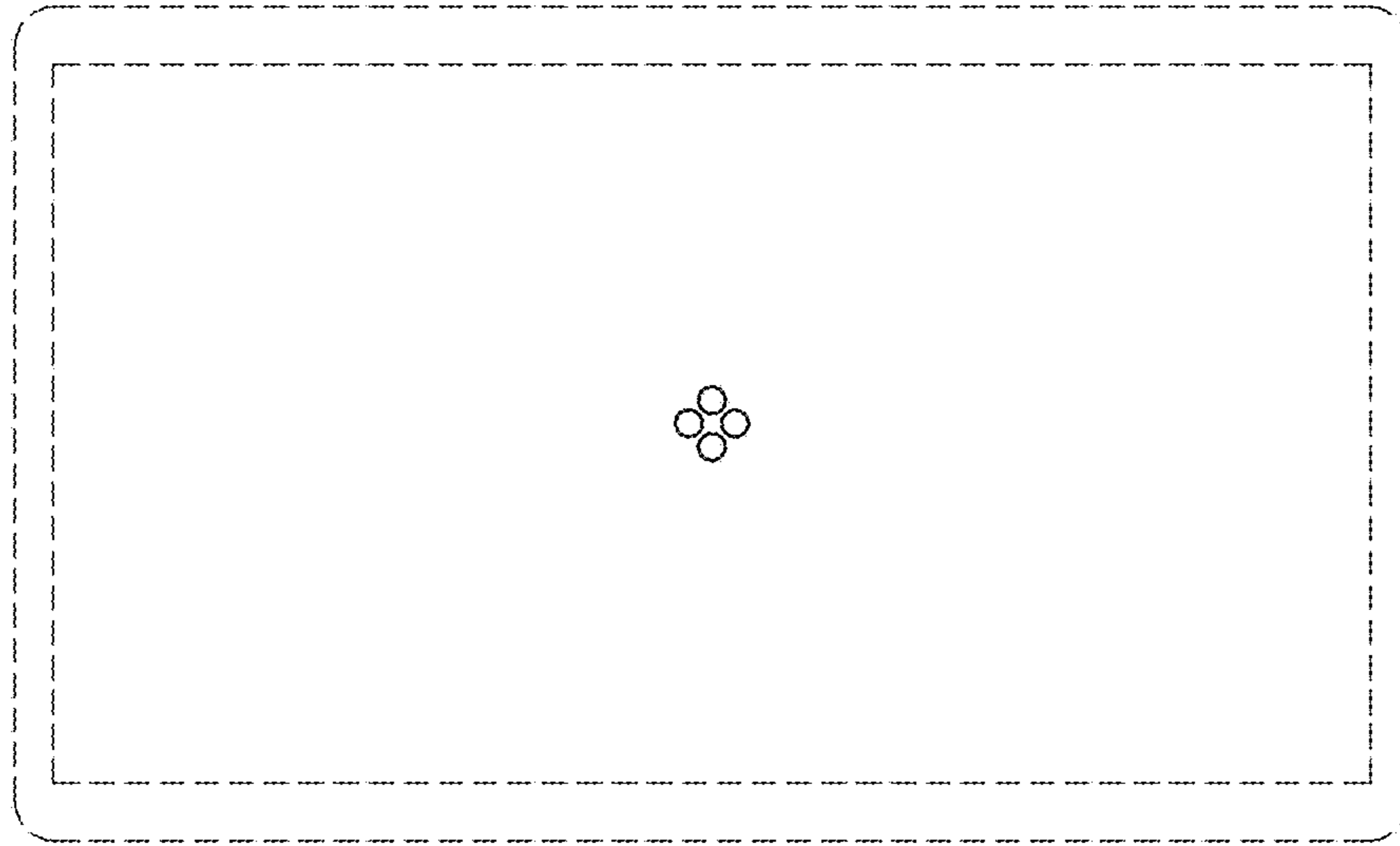

FIG. 2

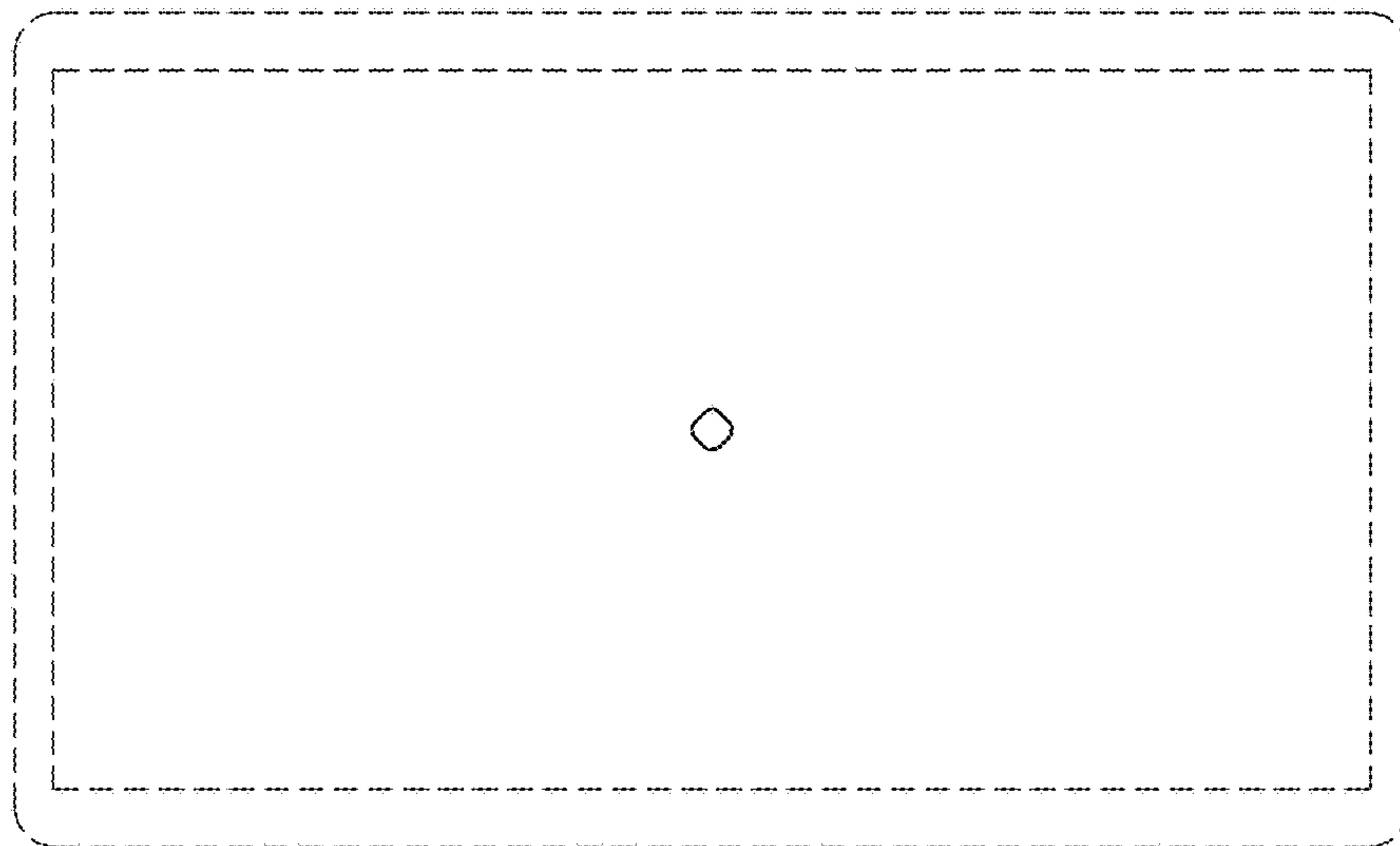

FIG. 1

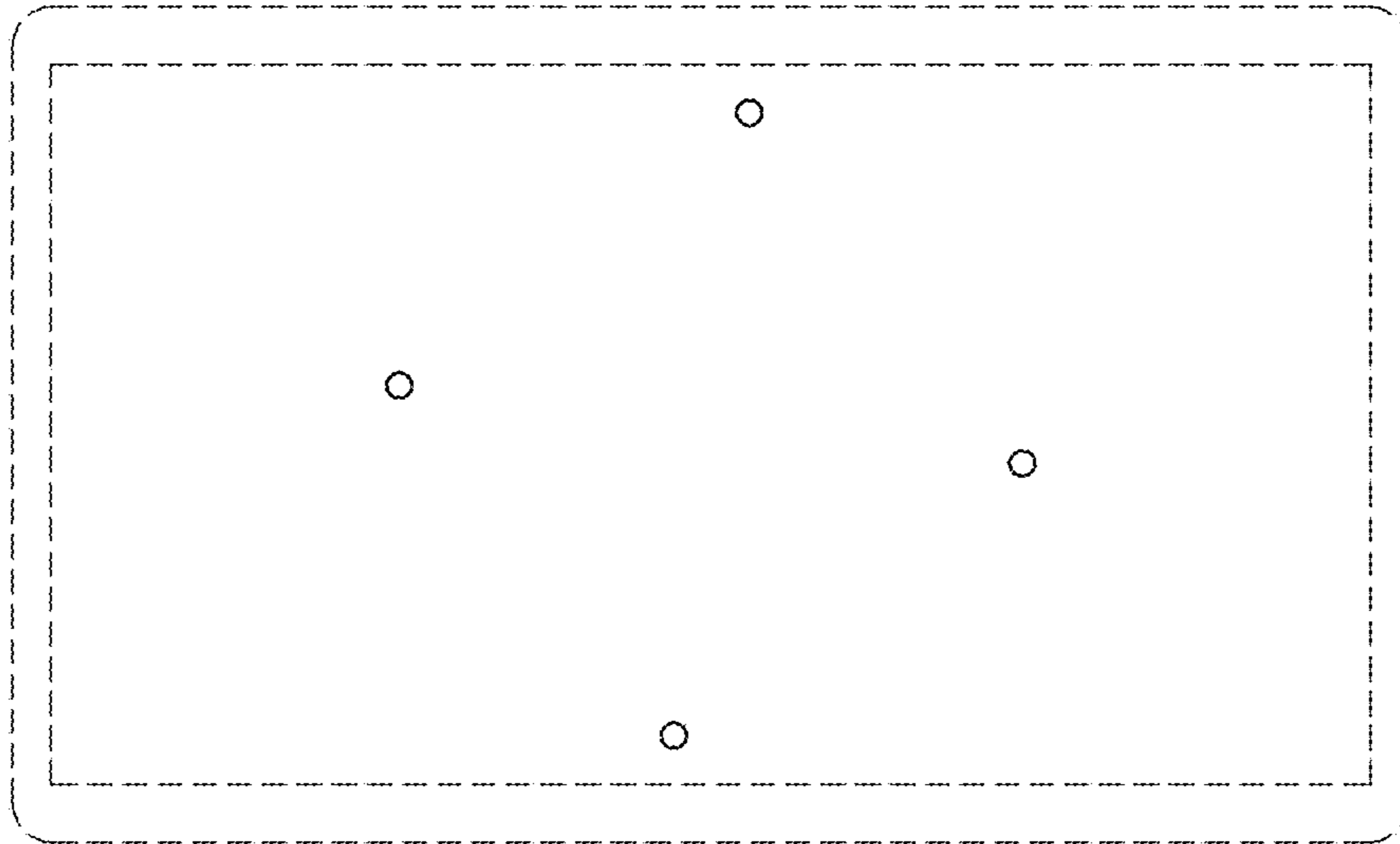

FIG. 4

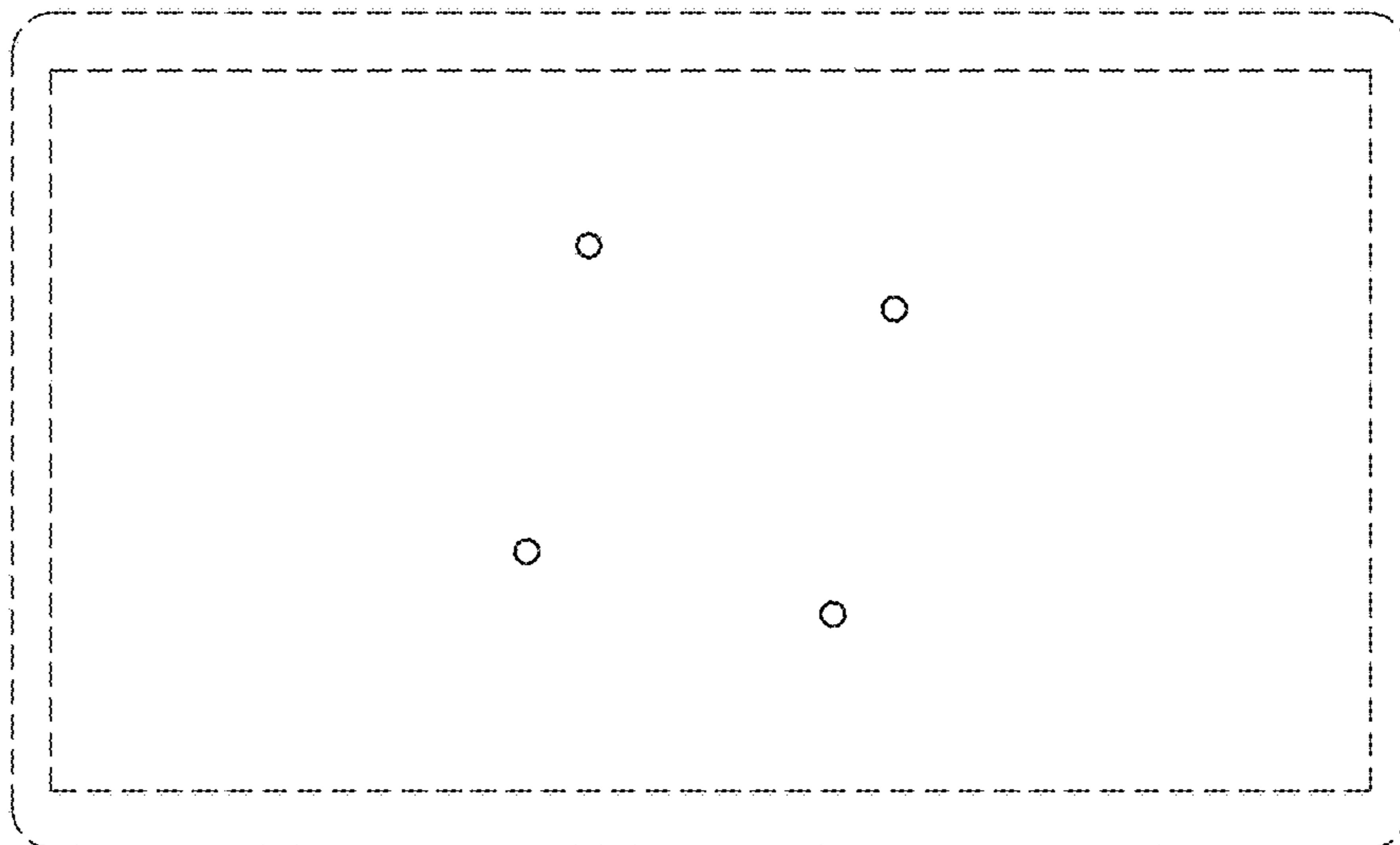

FIG. 3

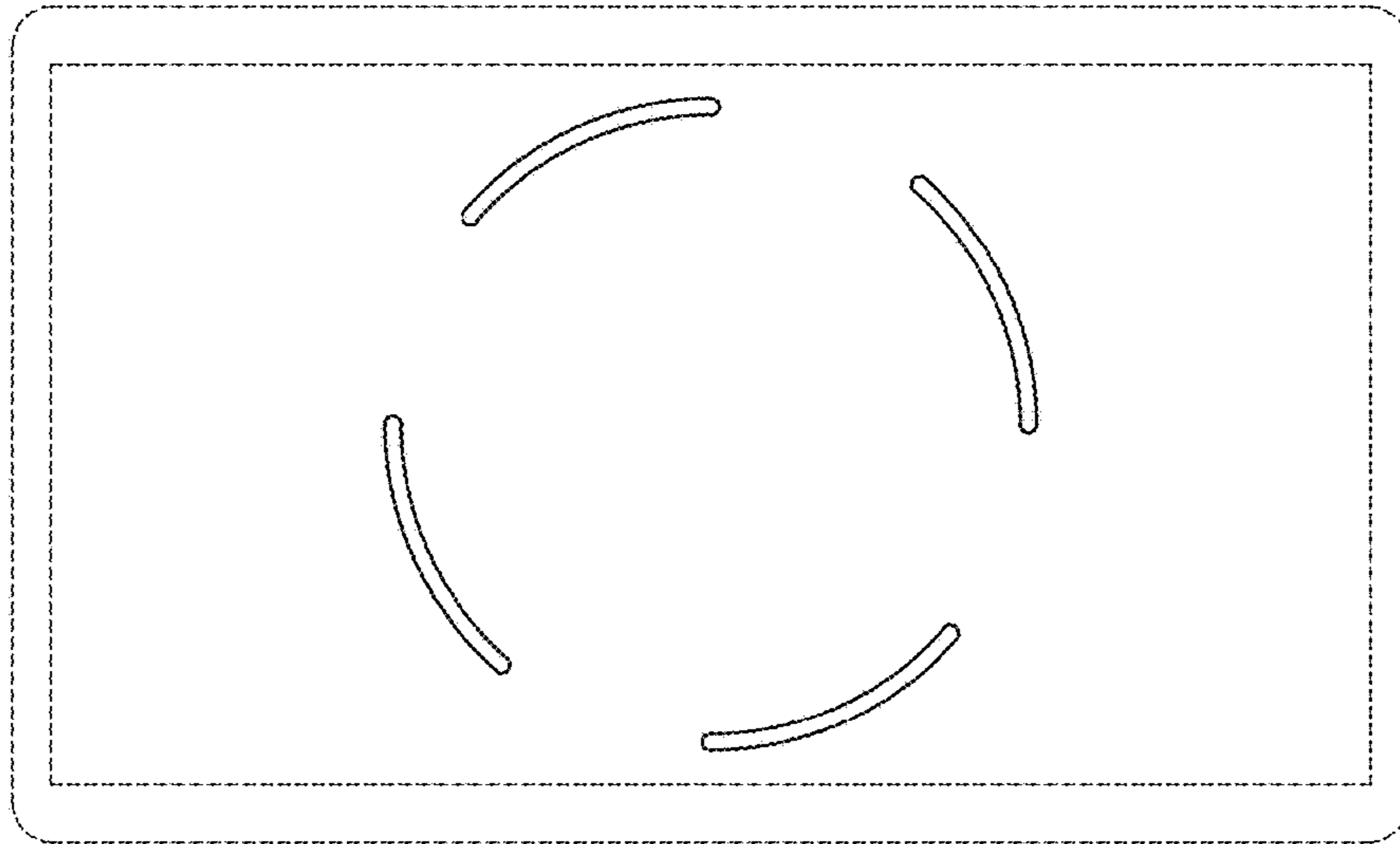

FIG. 6

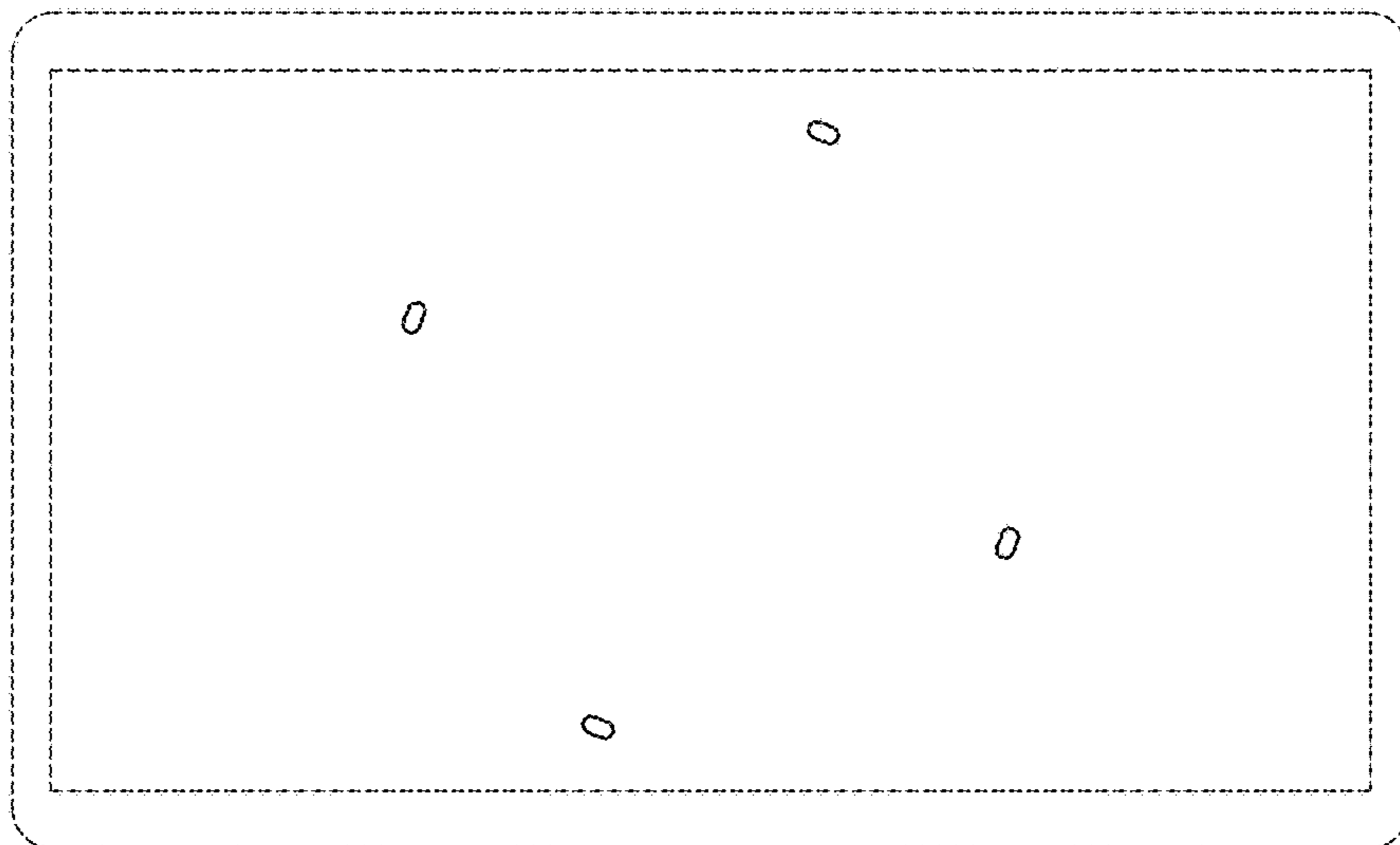

FIG. 5

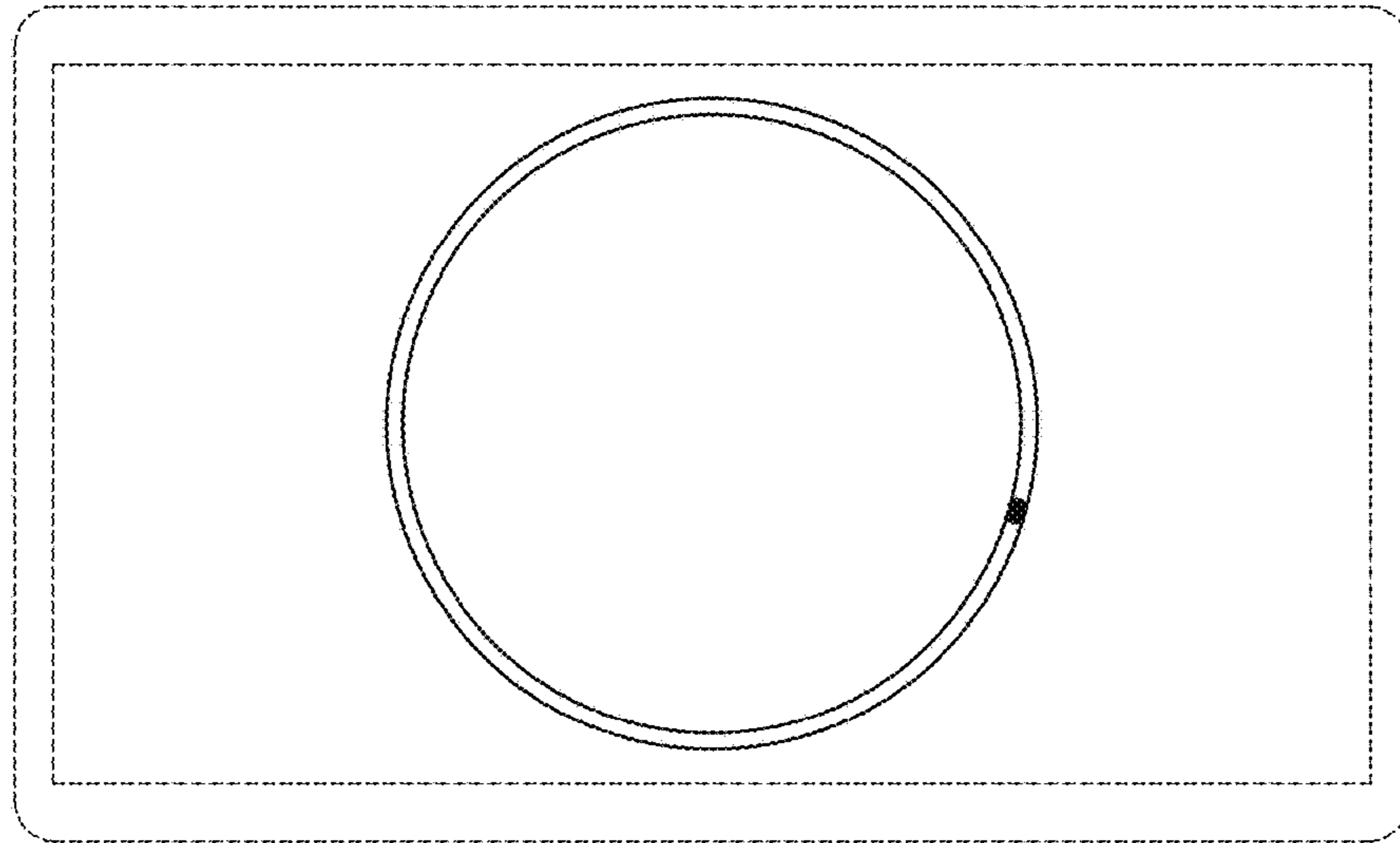

FIG. 8

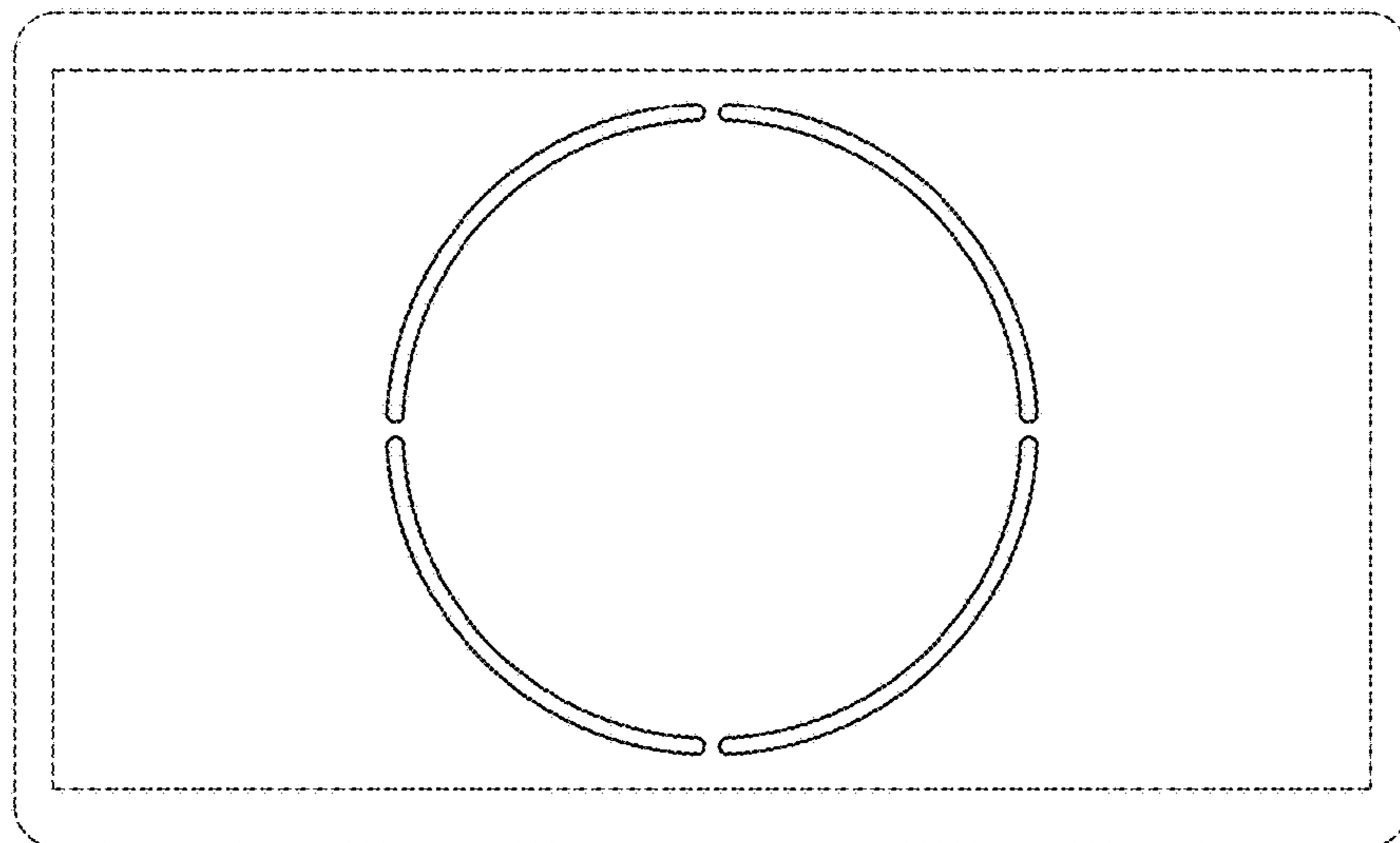

FIG. 7

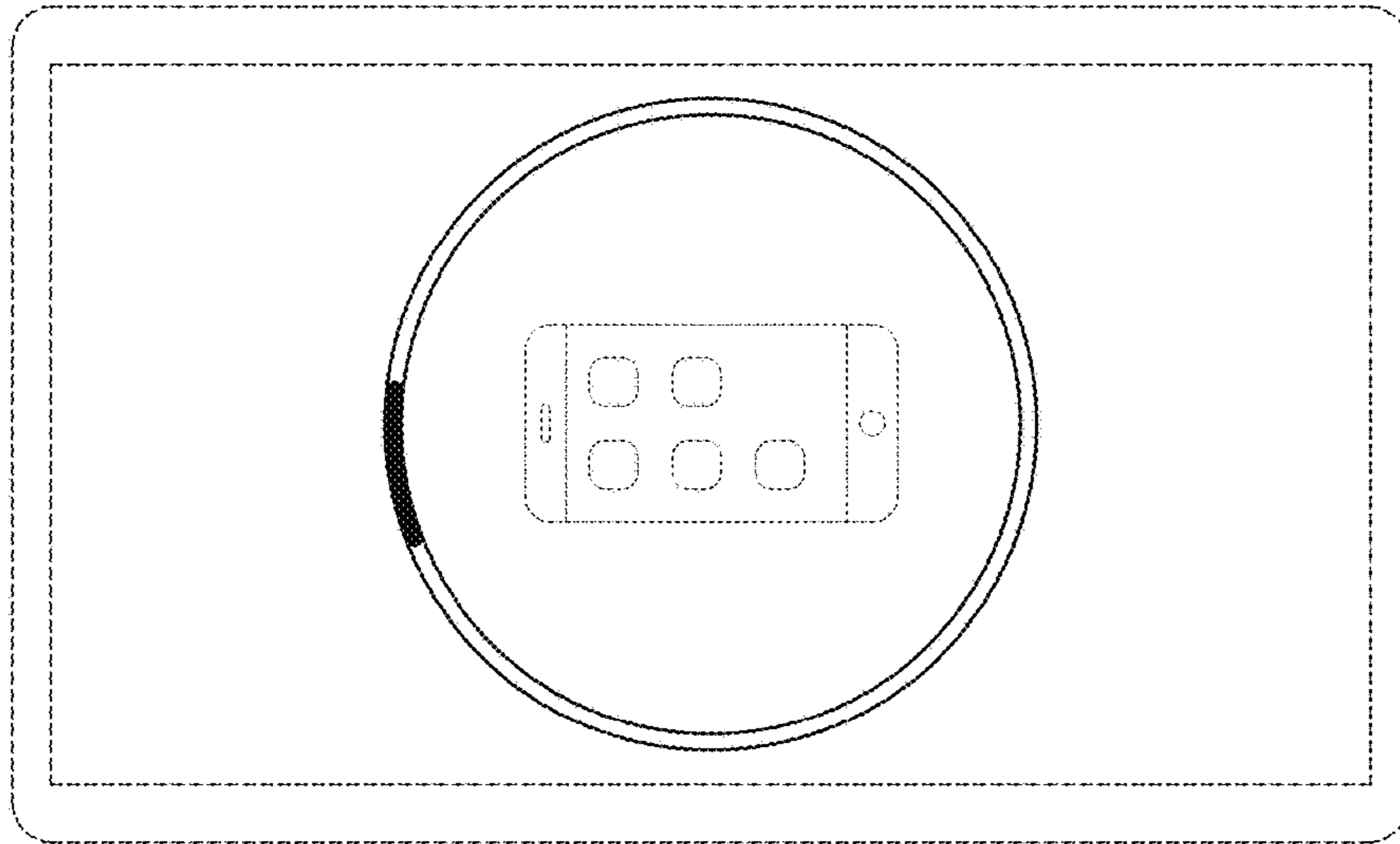

FIG. 10

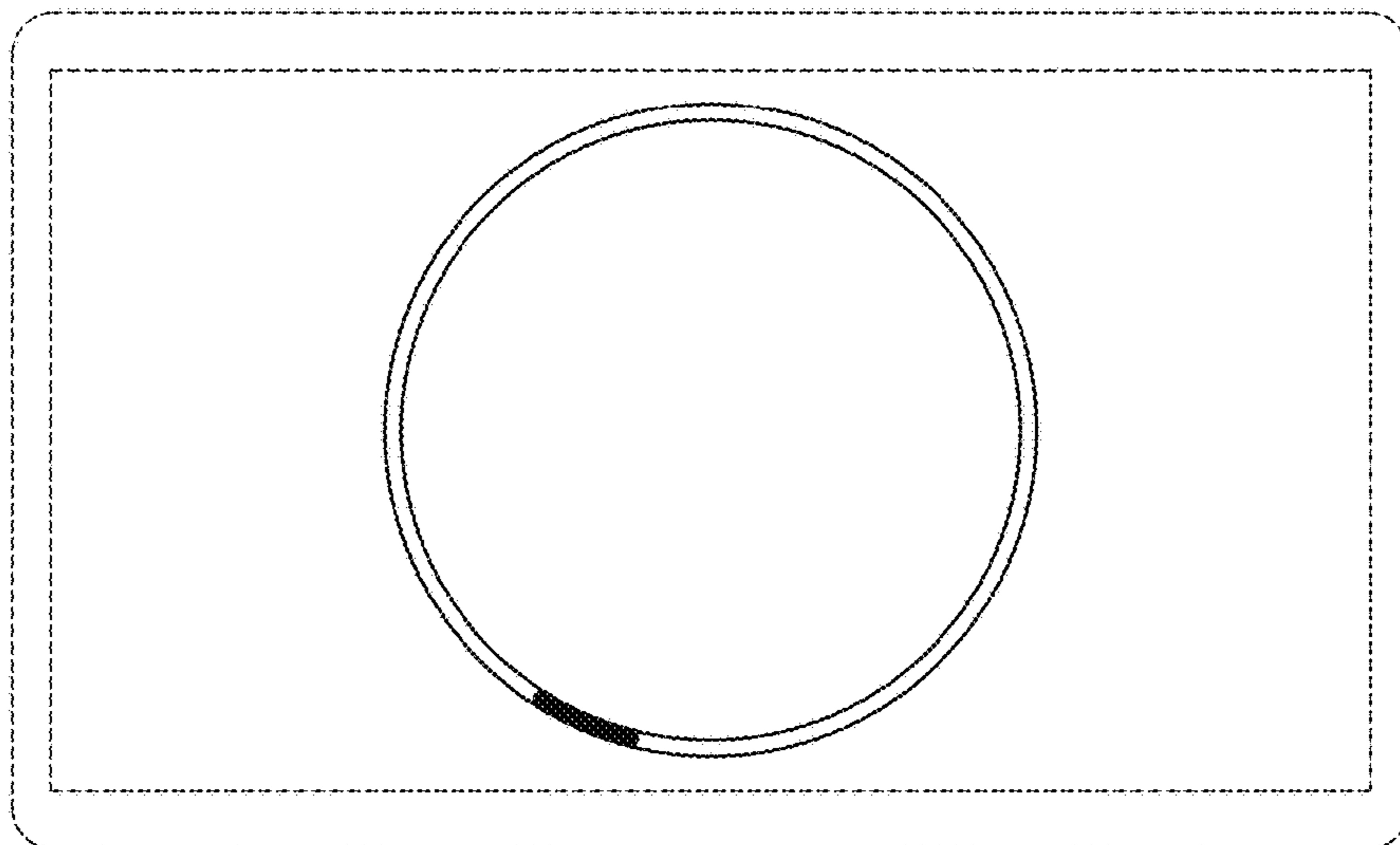

FIG. 9

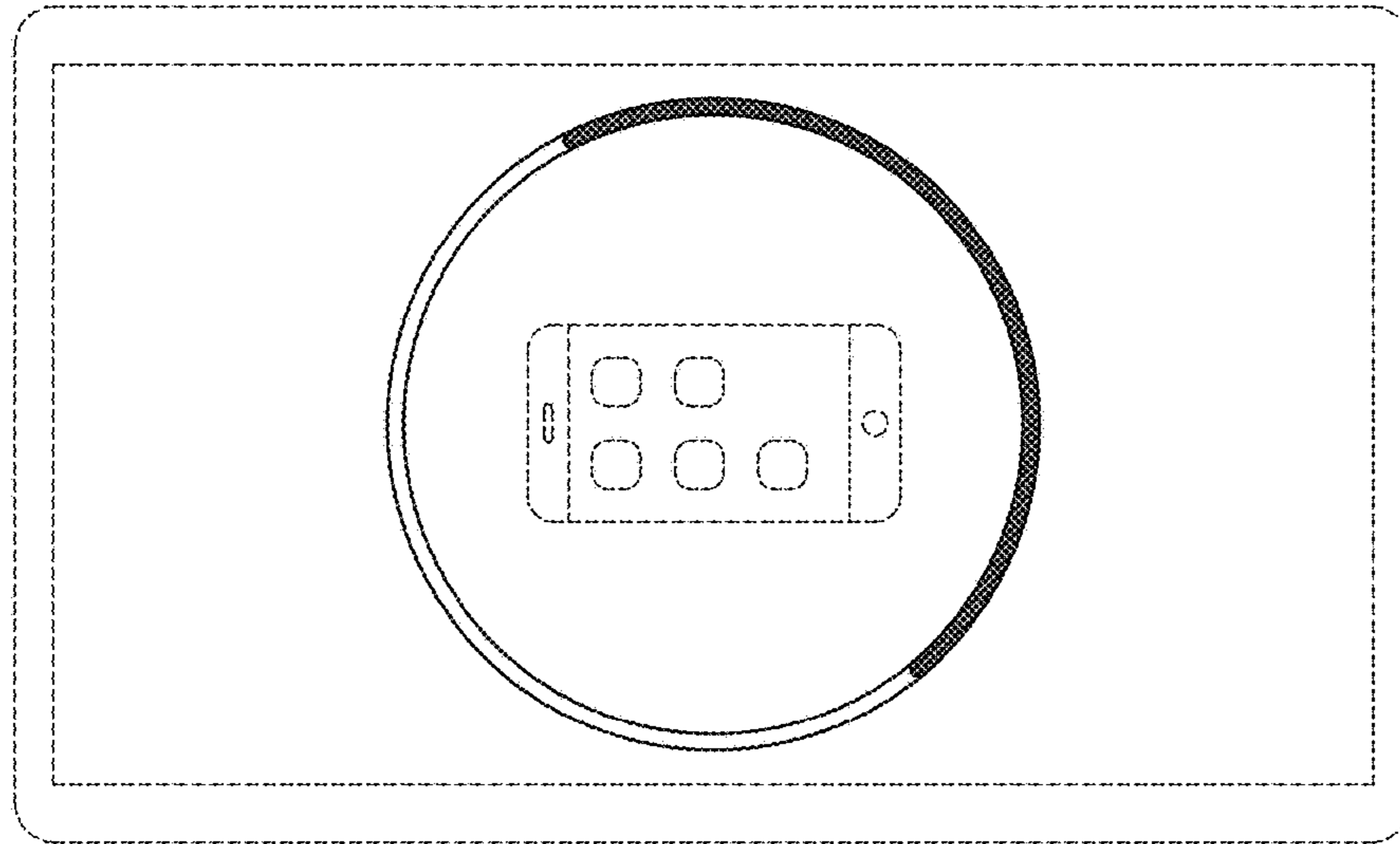

FIG. 12

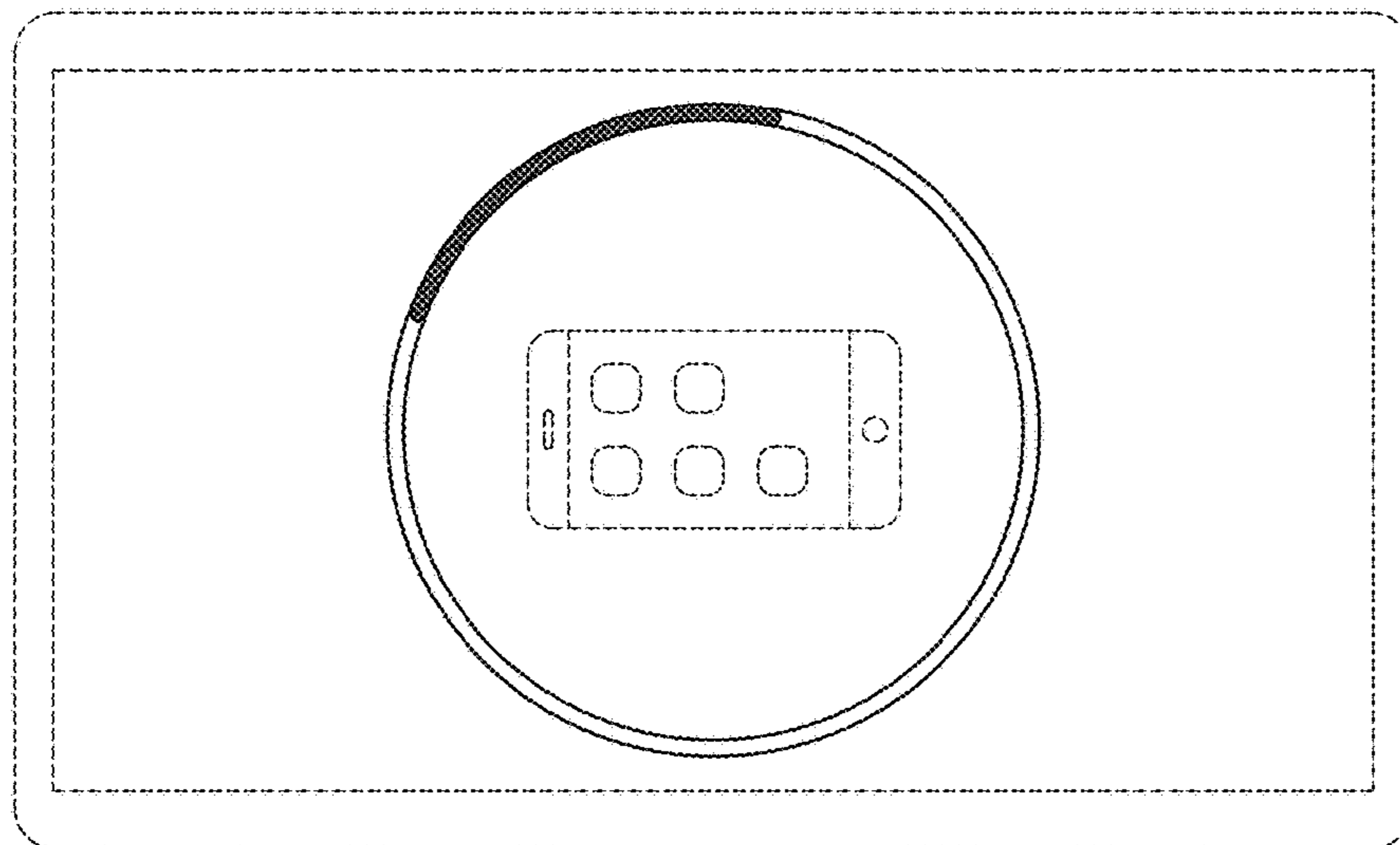

FIG. 11



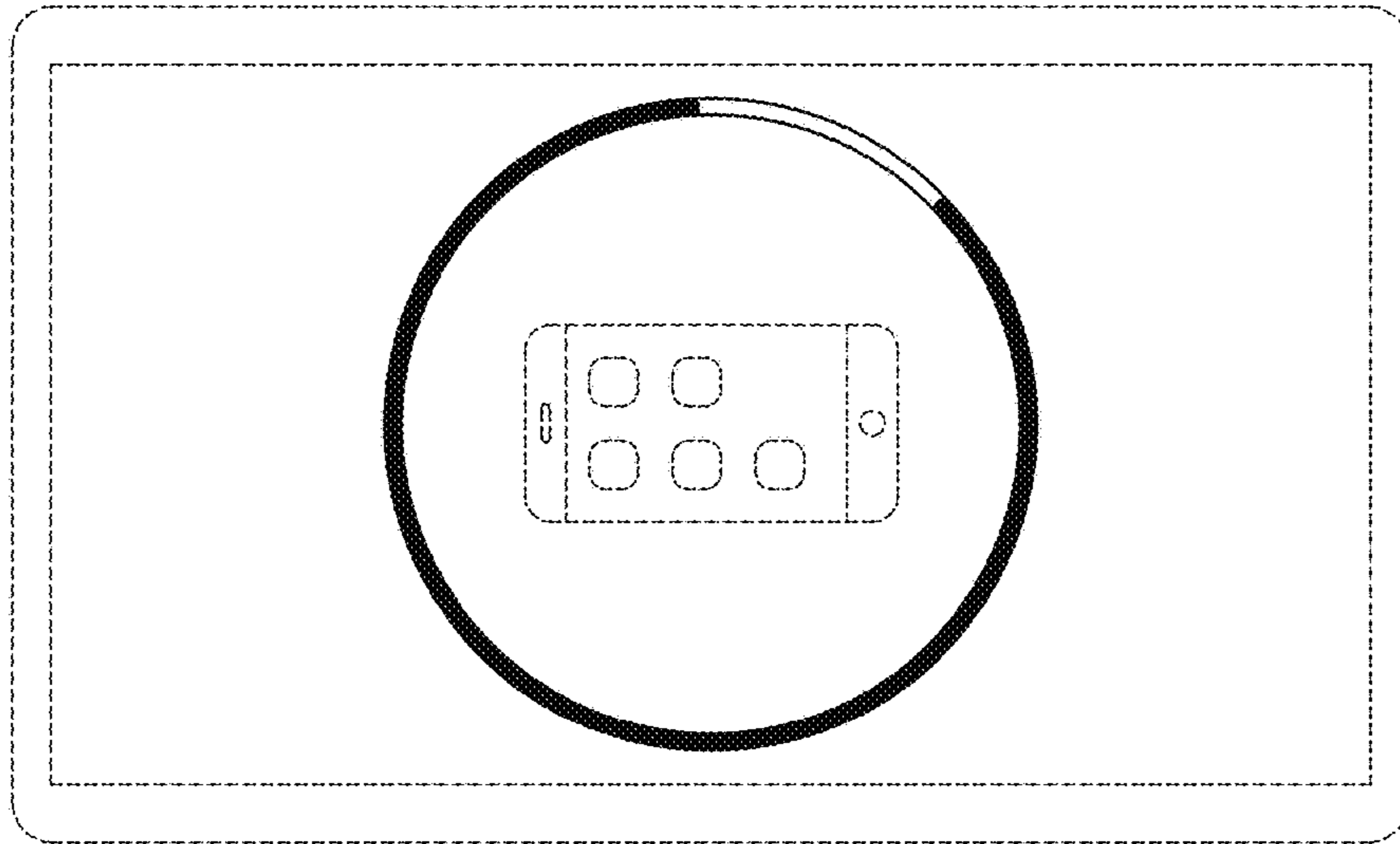

FIG. 14

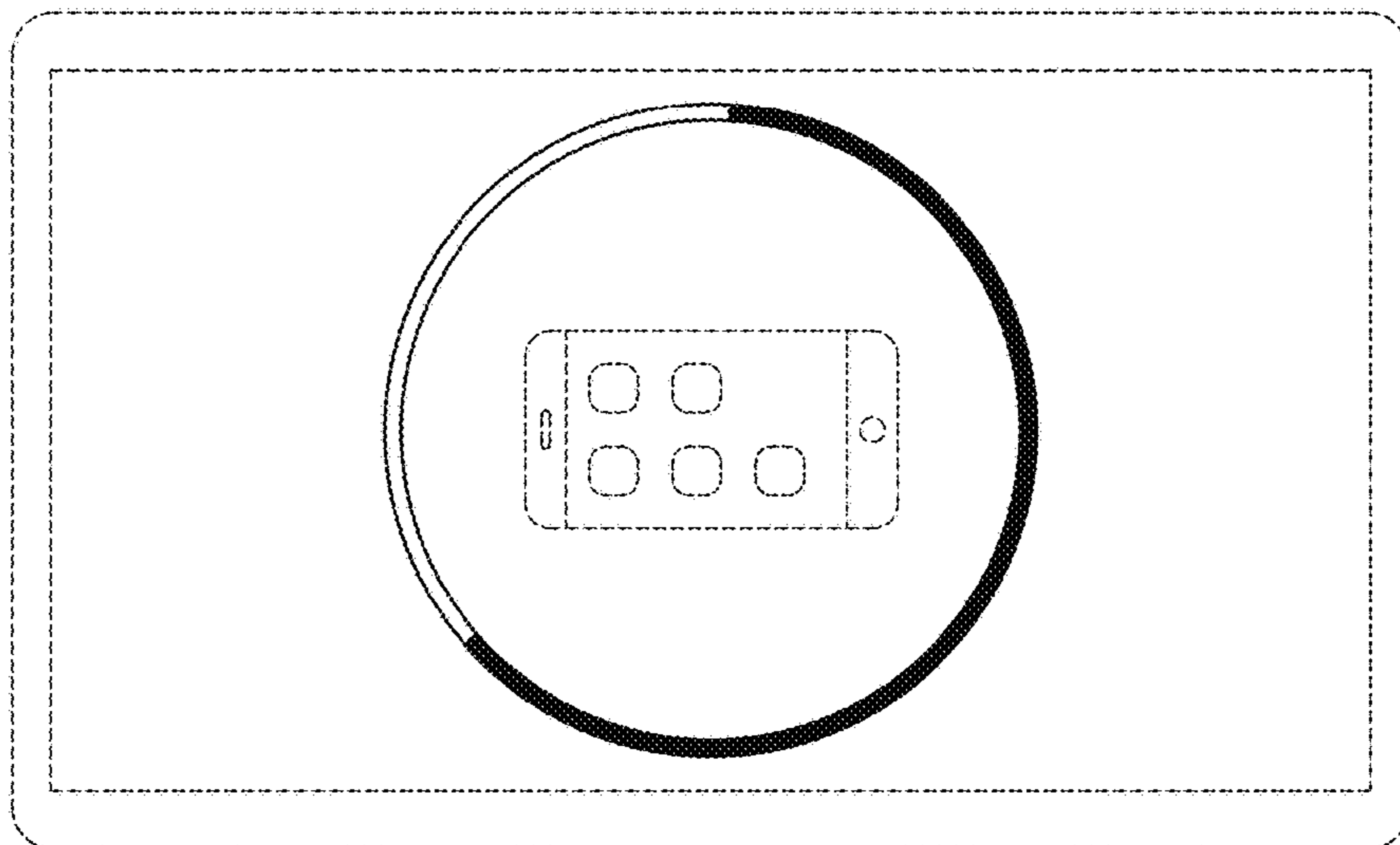

FIG. 13

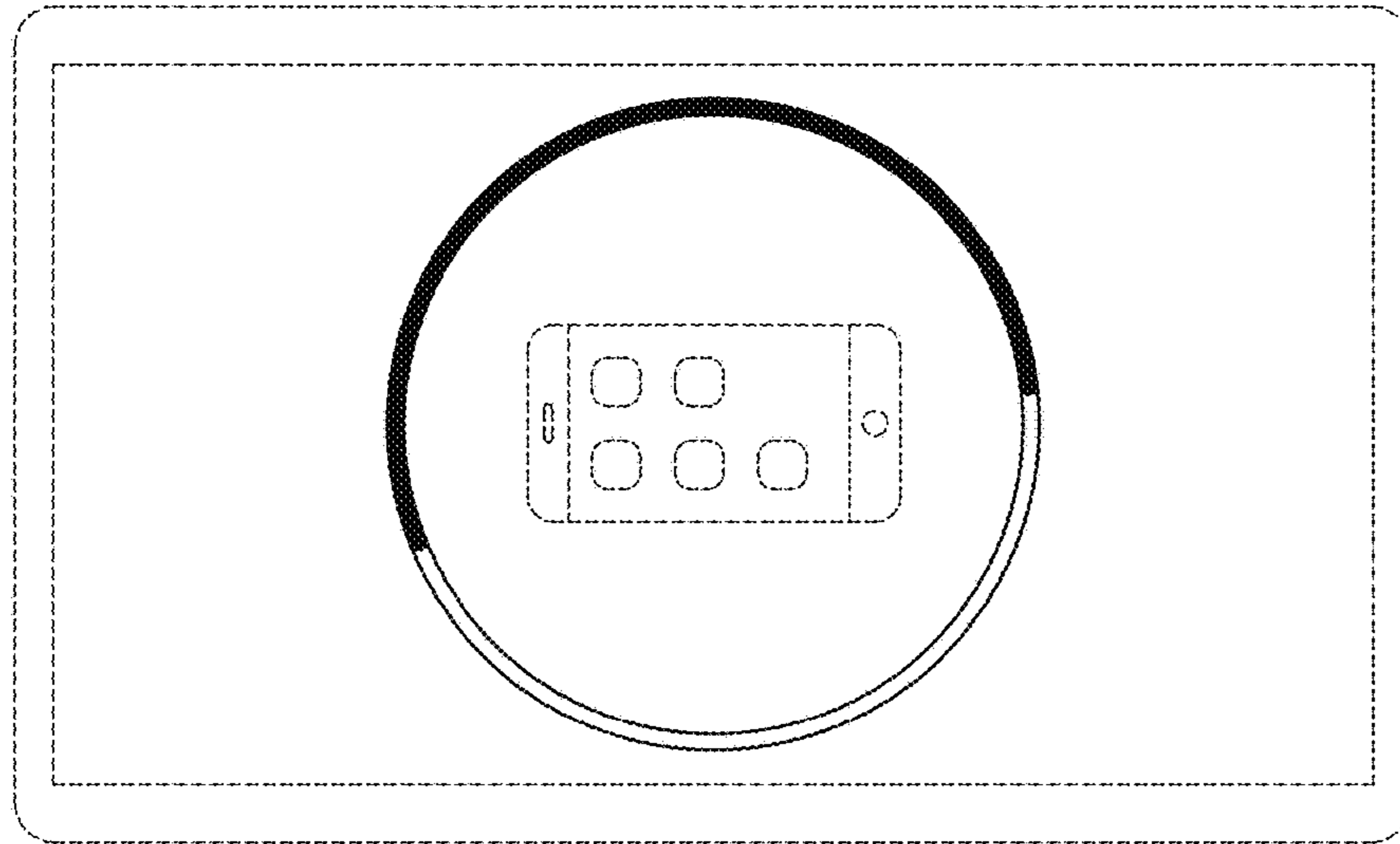

FIG. 16

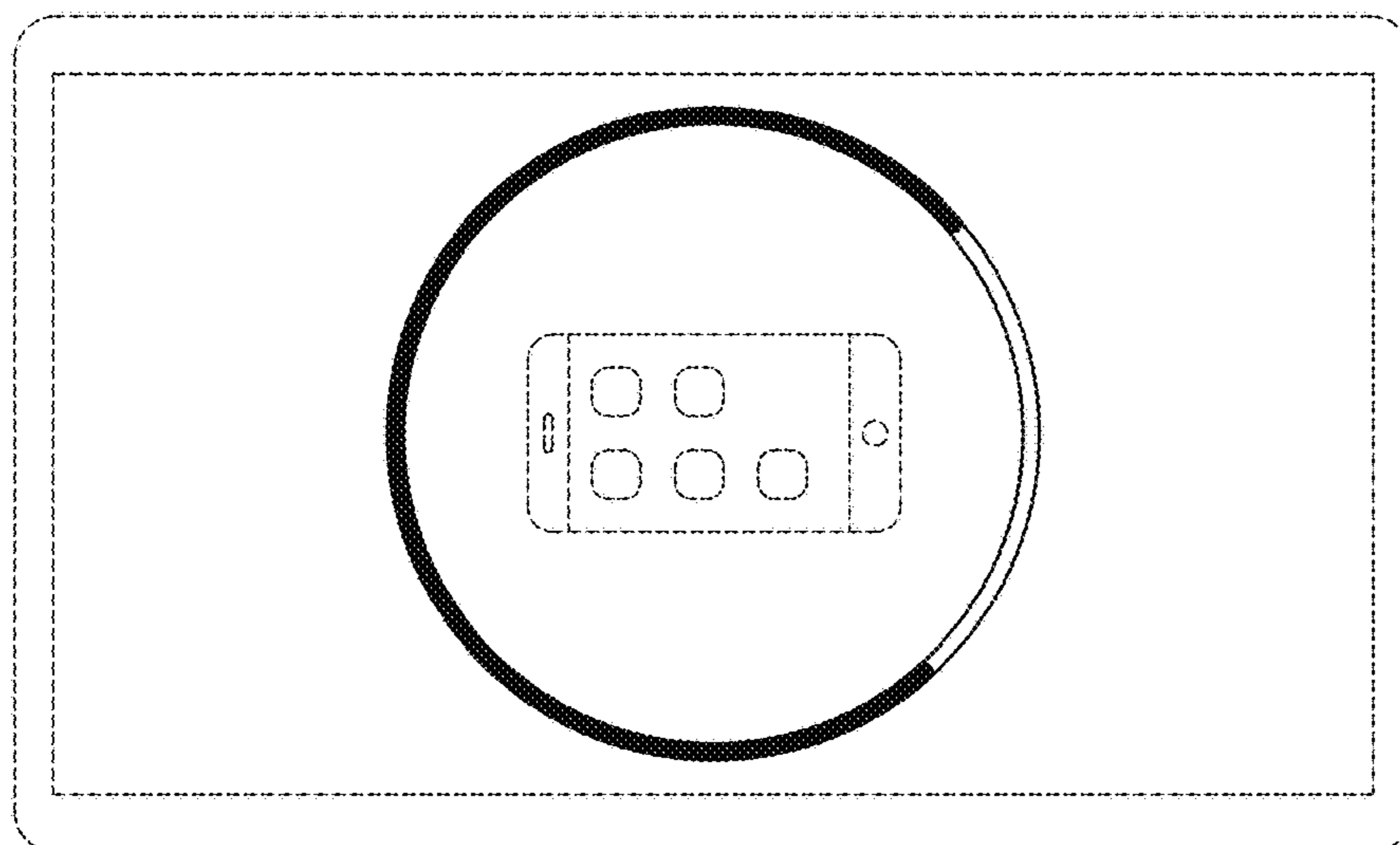

FIG. 15

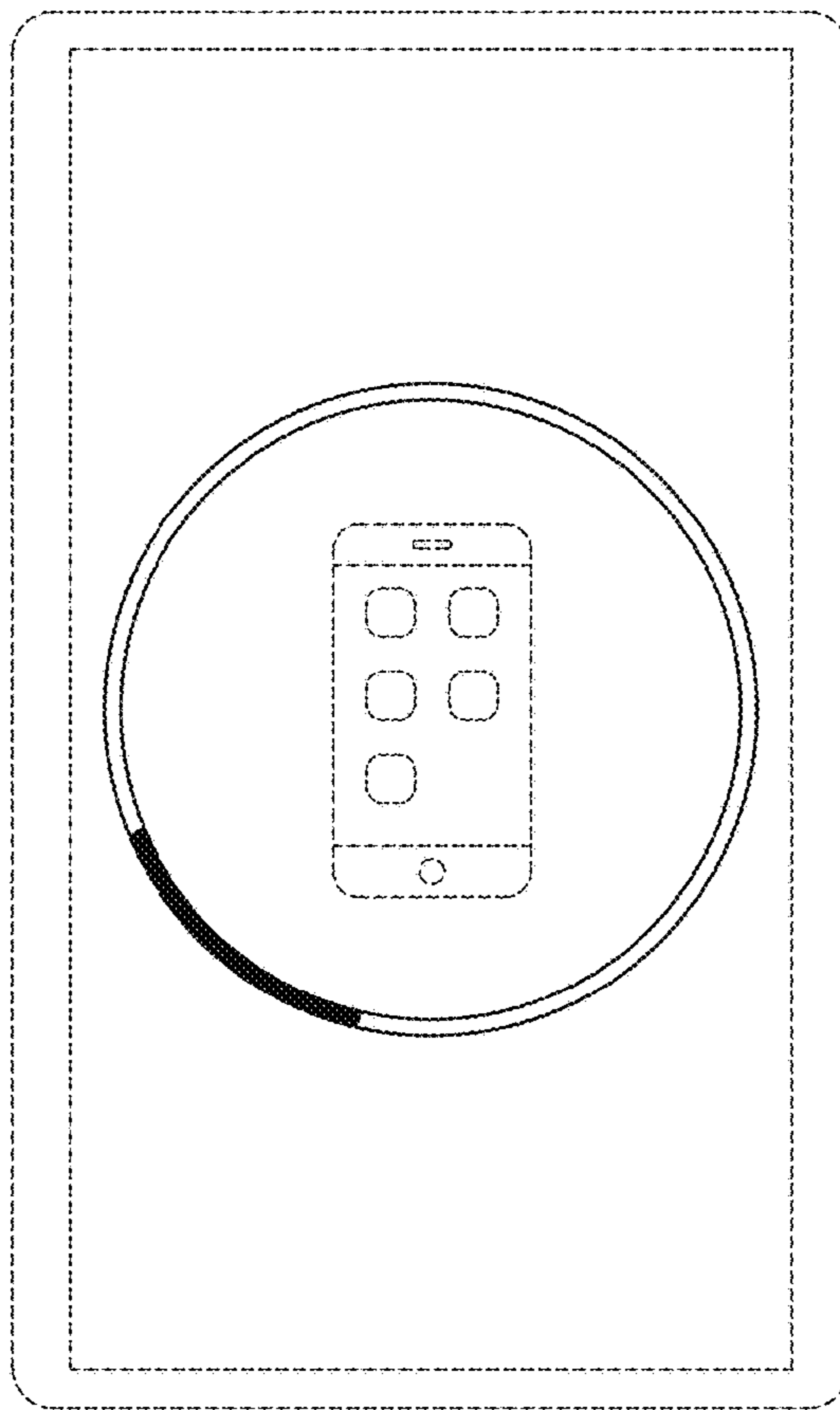

FIG. 17