

US00D872719S

(12) **United States Design Patent**  
**Knapp**

(10) **Patent No.:** **US D872,719 S**  
(45) **Date of Patent:** **\*\* Jan. 14, 2020**

(54) **ARTICULATING DISPLAY MOUNT**

D822,669 S \* 7/2018 Kwon ..... D14/451  
D822,671 S \* 7/2018 Chu ..... D14/452

(71) Applicant: **CKnapp Sales, Inc.**, Goodfield, IL (US)

\* cited by examiner

(72) Inventor: **Chance Knapp**, Goodfield, IL (US)

*Primary Examiner* — Randall H Gholson

(73) Assignee: **CKnapp Sales, Inc.**, Goodfield, IL (US)

(74) *Attorney, Agent, or Firm* — Hanley, Flight and Zimmerman, LLC

(\*\*) Term: **15 Years**

(57) **CLAIM**

(21) Appl. No.: **29/656,279**

The ornamental design for an “articulating display mount”, substantially as shown and described.

(22) Filed: **Jul. 11, 2018**

(51) **LOC (12) Cl.** ..... **14-03**

(52) **U.S. Cl.**  
USPC ..... **D14/239; D14/126**

**DESCRIPTION**

(58) **Field of Classification Search**  
USPC ..... D14/125–134, 239, 371, 136, 374–377, D14/440, 448, 450, 451, 452, 336, 342, D14/159; 312/7.2; 348/836, 838, 180, 348/184, 325, 739; 248/917–924, 465; 345/104, 133, 156, 168, 87, 173; D21/329, 515, 577, 622, 333, 433, 448, D21/452, 450, 331, 505; D10/15, 26; 446/484, 175, 356; D6/477, 479, 300; D20/10, 19, 39; D16/203, 241; 160/24  
CPC .... G06F 1/1601; G06F 1/1643; G06F 1/1652; G06F 1/1647; G06F 3/0412; H05K 5/0004; H05K 5/0017; H05K 5/02; H05K 5/0217; H04N 13/0459  
See application file for complete search history.

FIG. 1 is a first isometric view of an articulating display mount.  
FIG. 2 is a front view of the articulating display mount of FIG. 1.  
FIG. 3 is a rear view of the articulating display mount of FIG. 1.  
FIG. 4 is a bottom view of the articulating display mount of FIG. 1.  
FIG. 5 is a top view of the articulating display mount of FIG. 1.  
FIG. 6 is a first side view of the articulating display mount of FIG. 1; and,  
FIG. 7 is a second side view of the articulating display mount of FIG. 1.  
The features shown in broken lines form no part of the claimed design.

(56) **References Cited**

U.S. PATENT DOCUMENTS

D368,787 S \* 4/1996 Yuen ..... D26/63  
D794,619 S \* 8/2017 Kim ..... D14/239  
D798,848 S \* 10/2017 Frank ..... D14/239

**1 Claim, 7 Drawing Sheets**

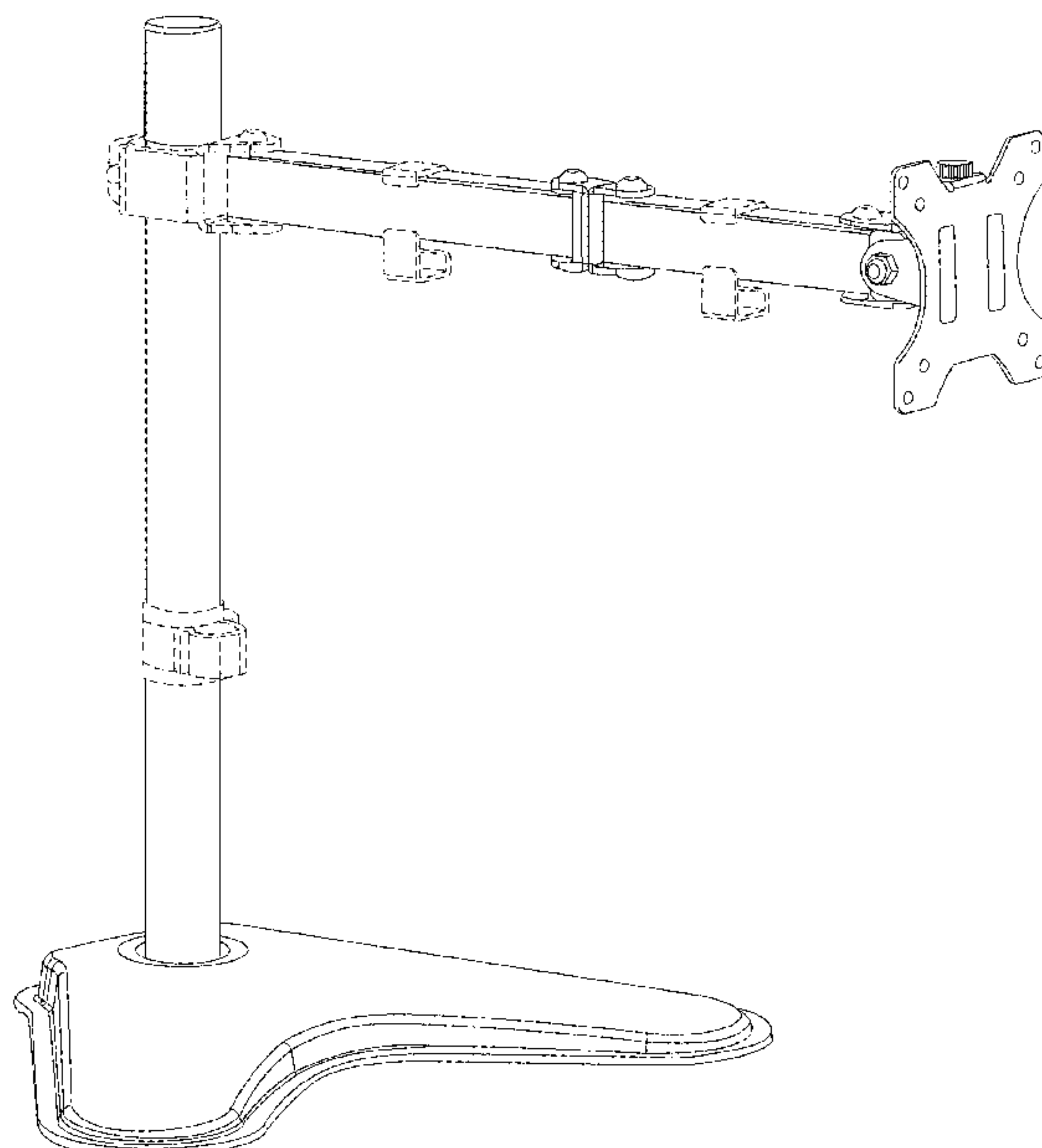

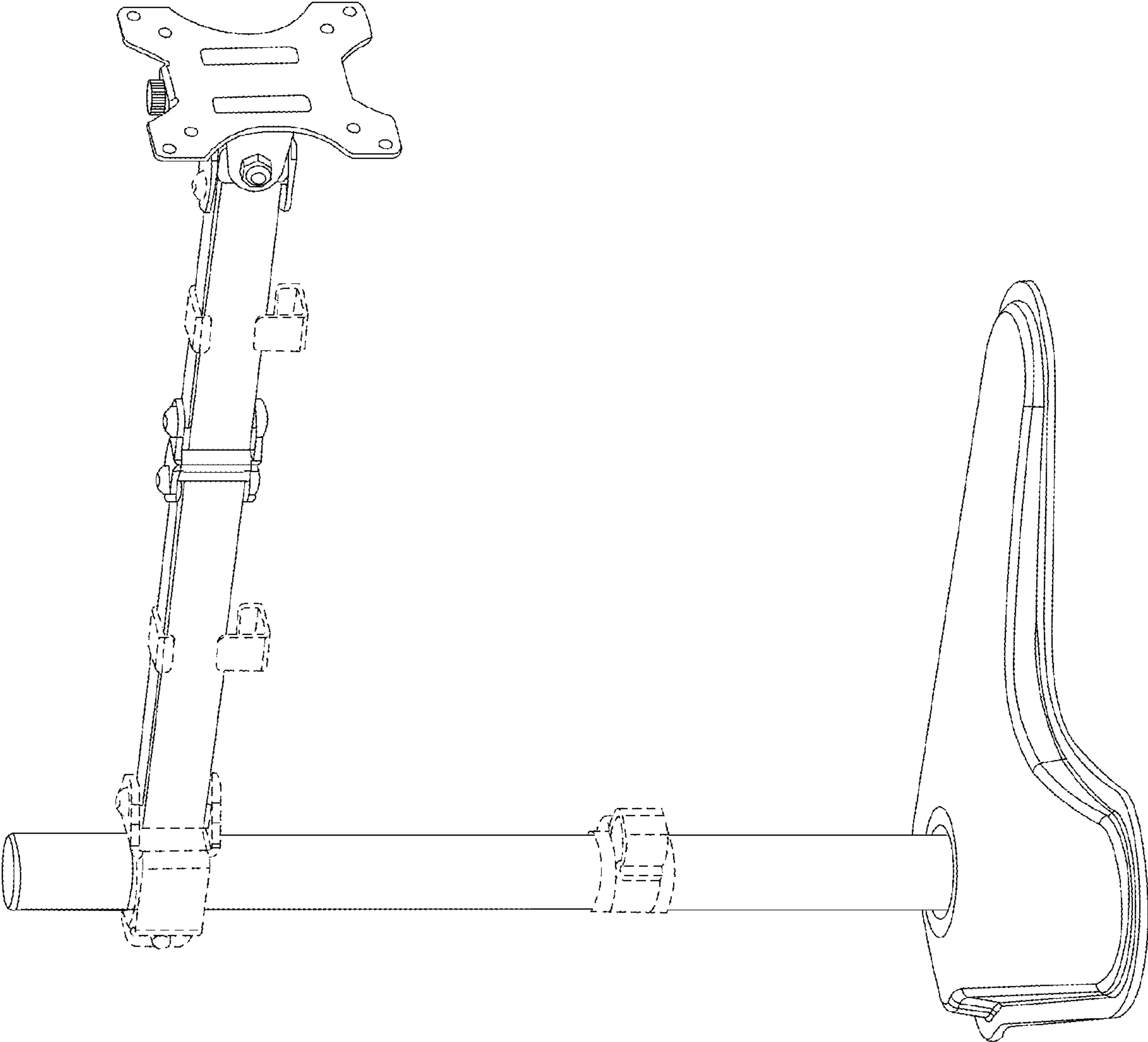

FIG. 1

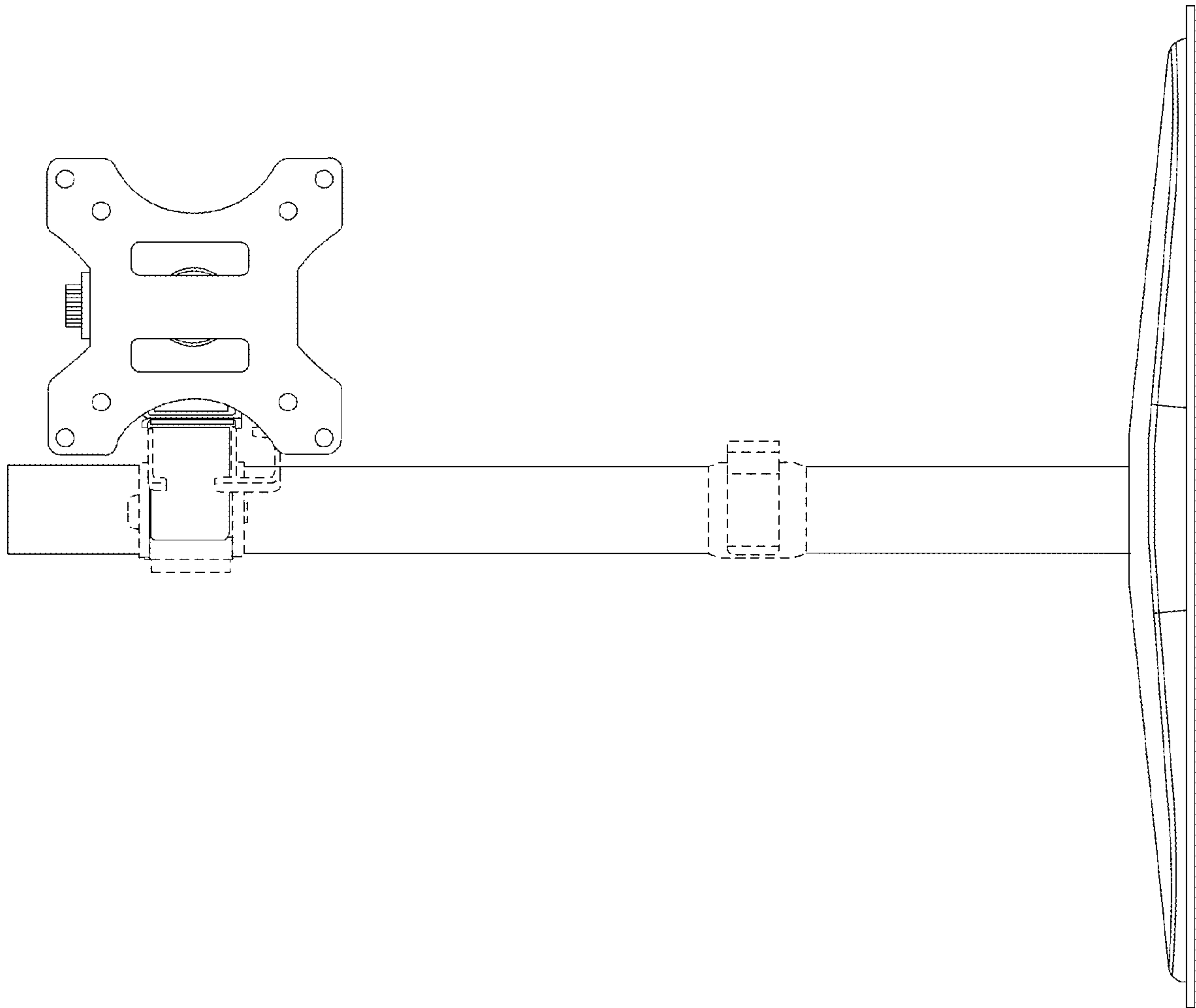

FIG. 2

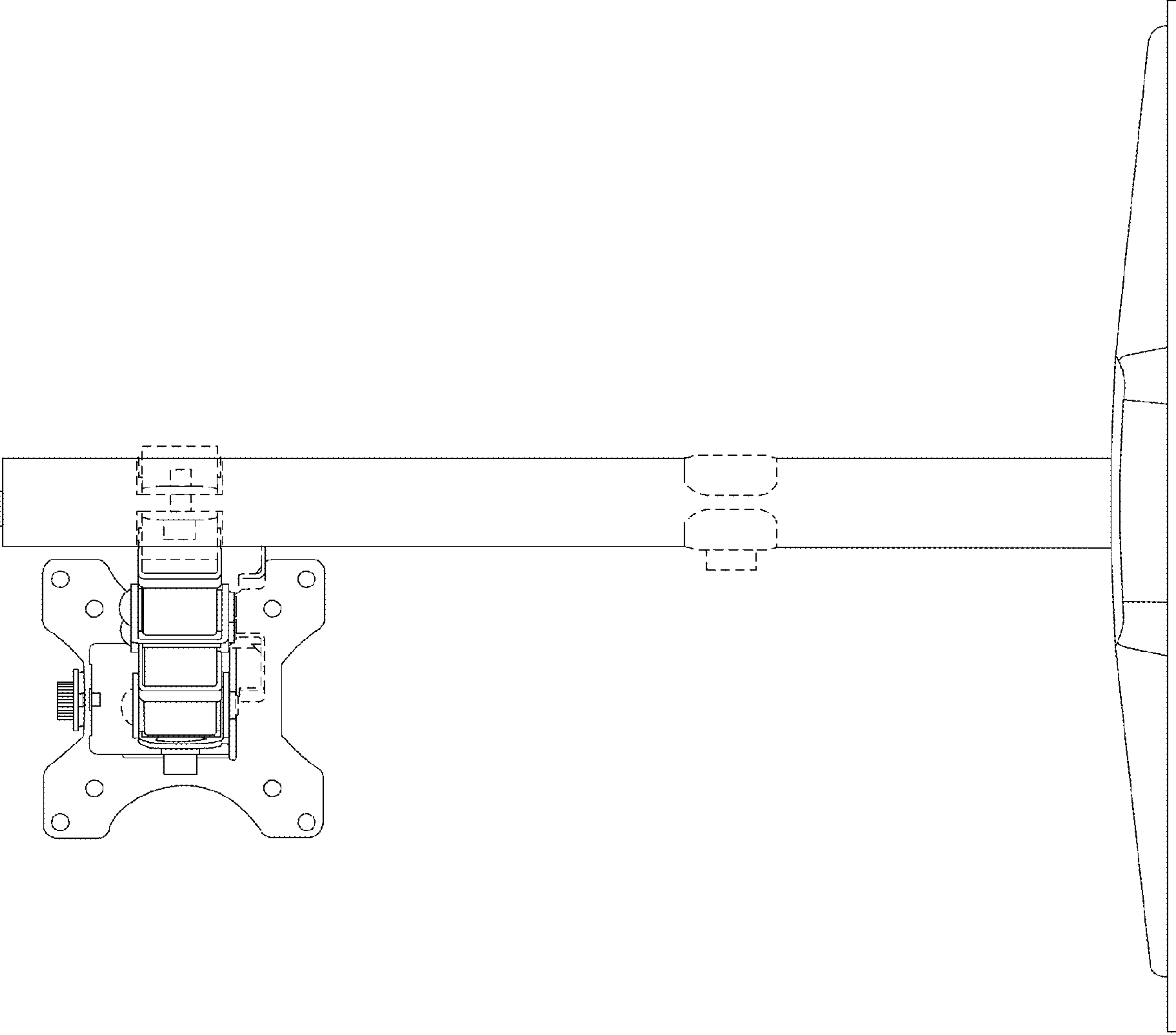

FIG. 3

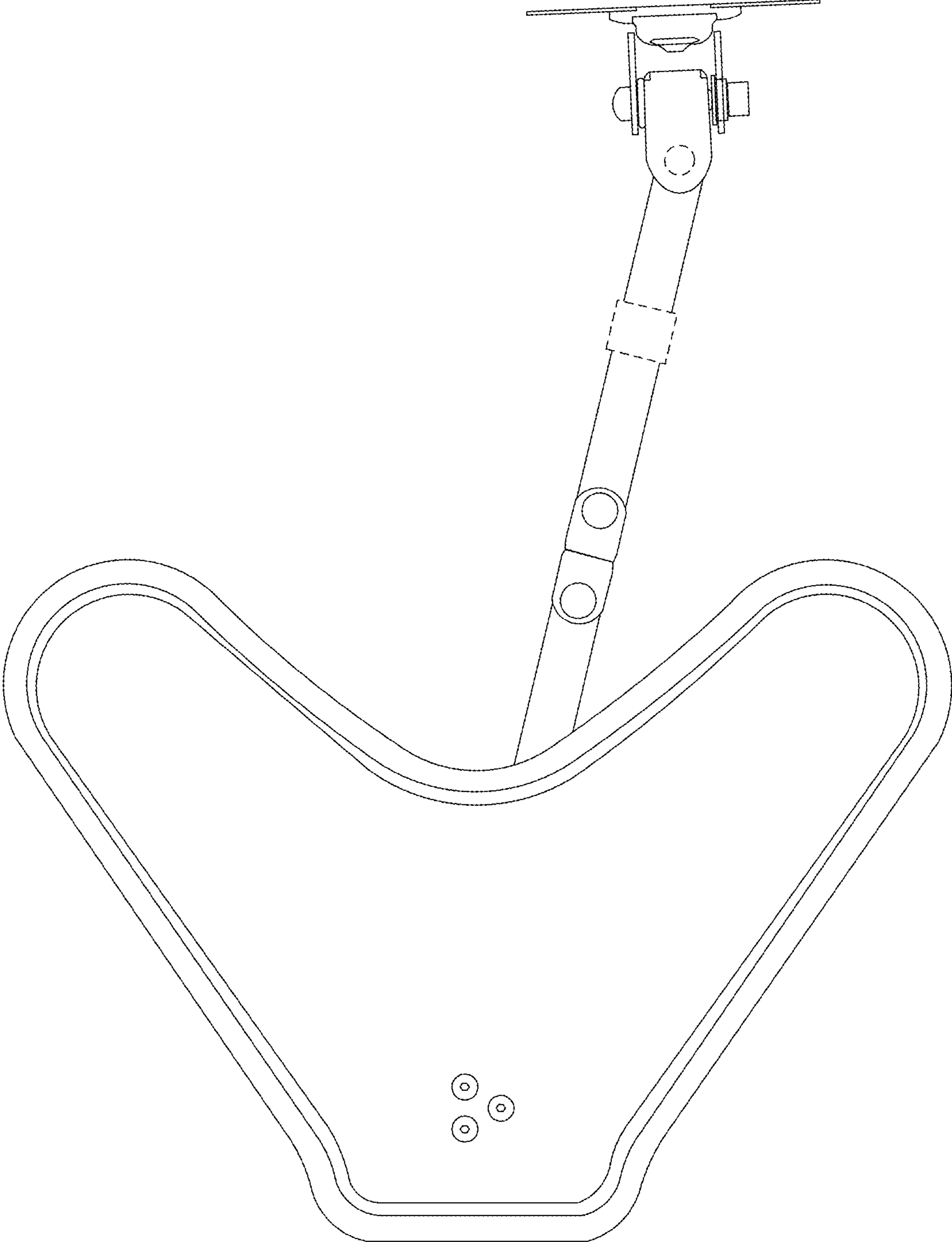

FIG. 4

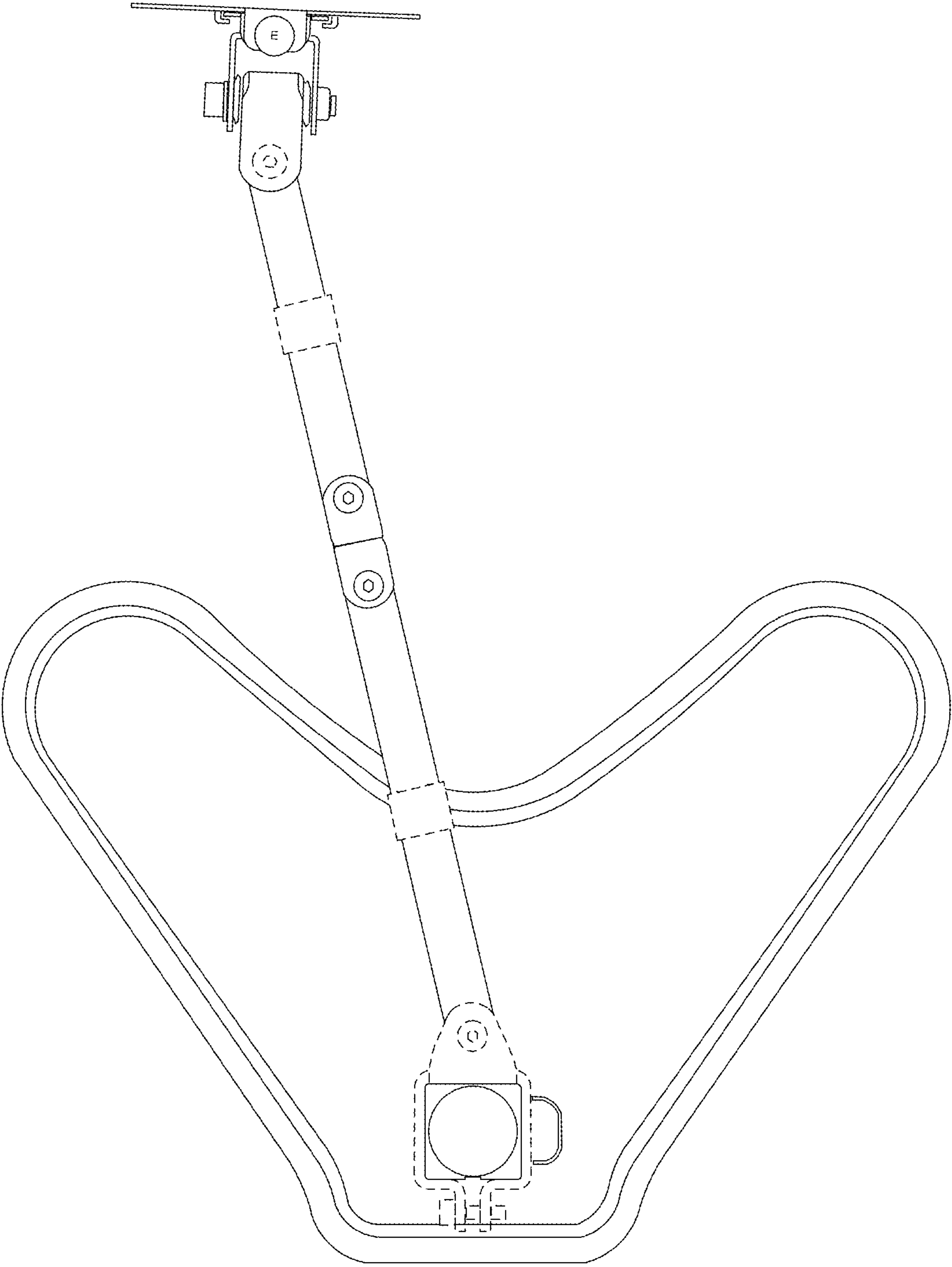

FIG. 5

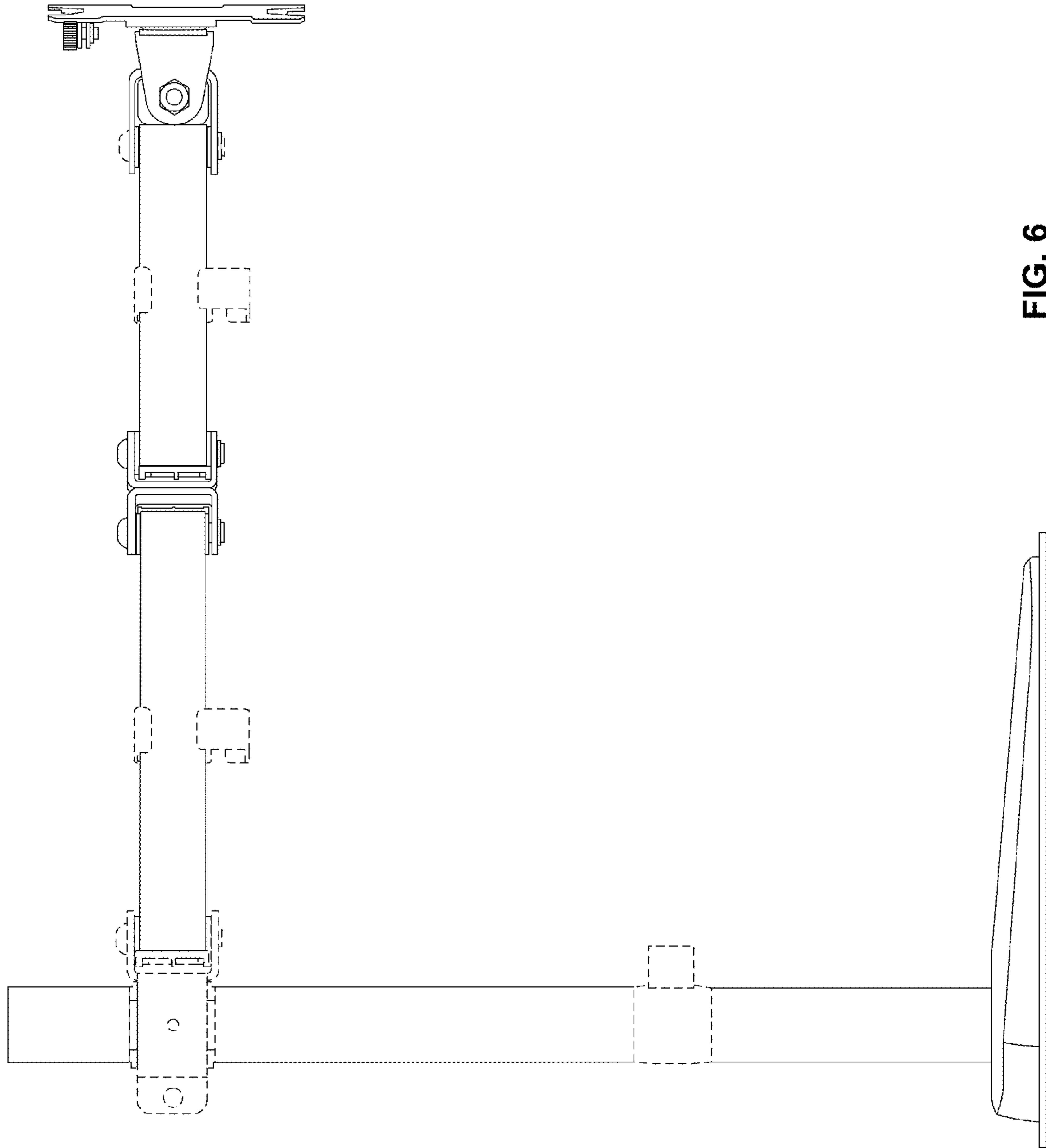

FIG. 6

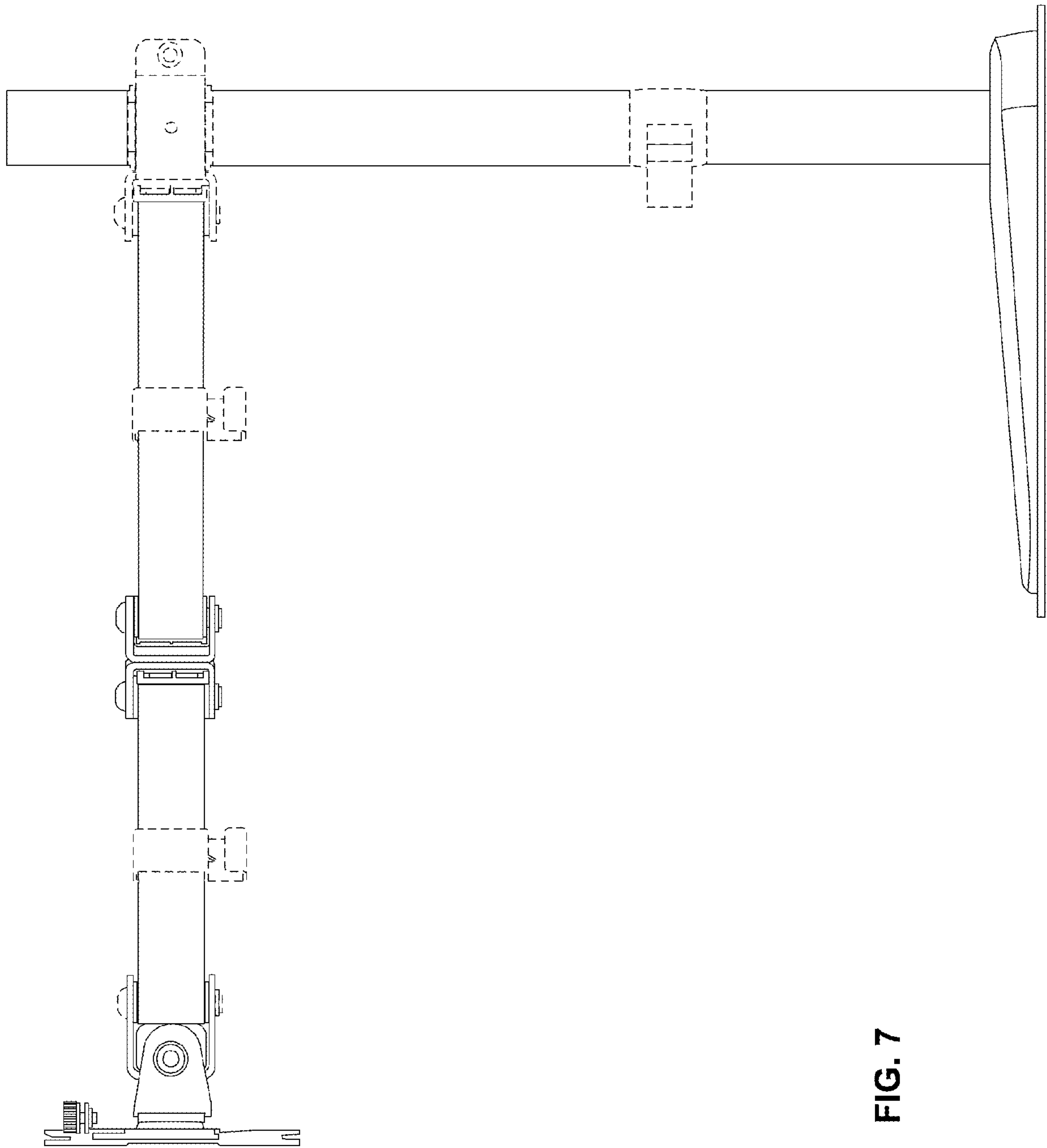

FIG. 7