



US00D872703S

(12) **United States Design Patent** (10) **Patent No.:** **US D872,703 S**
Seo et al. (45) **Date of Patent:** **** *Jan. 14, 2020**

(54) **ELECTRONIC DEVICE**

- (71) Applicant: **Samsung Electronics Co., Ltd.**, Suwon-si (KR)
- (72) Inventors: **Jae-Hun Seo**, Suwon-si (KR); **Hyok-Su Choi**, Seoul (KR); **Hyoung-Shin Park**, Seoul (KR); **Yun-Jin Kim**, Seoul (KR)
- (73) Assignee: **SAMSUNG ELECTRONICS CO., LTD.**, Suwon-si (KR)
- (*) Notice: This patent is subject to a terminal disclaimer.

(**) Term: **15 Years**

(21) Appl. No.: **29/623,656**

(22) Filed: **Oct. 26, 2017**

(30) **Foreign Application Priority Data**

Apr. 28, 2017 (KR) 30-2017-0020105

(51) **LOC (12) Cl.** **14-03**

(52) **U.S. Cl.**
USPC **D14/138 G**

(58) **Field of Classification Search**
USPC D14/138 G, 138 AD, 341, 138 R, 496,
D14/203.1, 203.3, 203.5, 203.7, 248;
(Continued)

(56) **References Cited**

U.S. PATENT DOCUMENTS

- D698,770 S * 2/2014 Park D14/248
 - D701,191 S * 3/2014 Suk D14/138 G
- (Continued)

FOREIGN PATENT DOCUMENTS

- CN 304030502 * 2/2017
- CN 304081440 * 3/2017
- JP D1601001 * 5/2017

OTHER PUBLICATIONS

Samsung Galaxy S8, released Apr. 2017, [online], [site visited Dec. 30, 2018]. Available from Internet, <URL: https://www.gsmarena.com/samsung_galaxy_s8-pictures-8161.php>.*

(Continued)

Primary Examiner — Jeffrey D Asch
(74) *Attorney, Agent, or Firm* — McAndrews Held & Malloy, Ltd.

(57) **CLAIM**

The ornamental design for an electronic device, as shown and described.

DESCRIPTION

FIG. 1 is a front perspective view of an electronic device showing our new design according to a first embodiment; FIG. 2 is a front elevation view thereof; FIG. 3 is a rear elevation view thereof; FIG. 4 is a left side elevation view thereof; FIG. 5 is a right side elevation view thereof; FIG. 6 is a top plan view thereof; FIG. 7 is a bottom plan view thereof; FIG. 8 is a rear perspective view thereof; FIG. 9 is a front perspective view of an electronic device showing our new design according to a second embodiment; FIG. 10 is a front elevation view thereof; FIG. 11 is a rear elevation view thereof; FIG. 12 is a left side elevation view thereof; FIG. 13 is a right side elevation view thereof; FIG. 14 is a top plan view thereof; FIG. 15 is a bottom plan view thereof; FIG. 16 is a rear perspective view thereof; FIG. 17 is a front perspective view of an electronic device showing our new design according to a third embodiment; FIG. 18 is a front elevation view thereof; FIG. 19 is a rear elevation view thereof; FIG. 20 is a left side elevation view thereof; FIG. 21 is a right side elevation view thereof; FIG. 22 is a top plan view thereof; FIG. 23 is a bottom plan view thereof; FIG. 24 is a rear perspective view thereof;

(Continued)

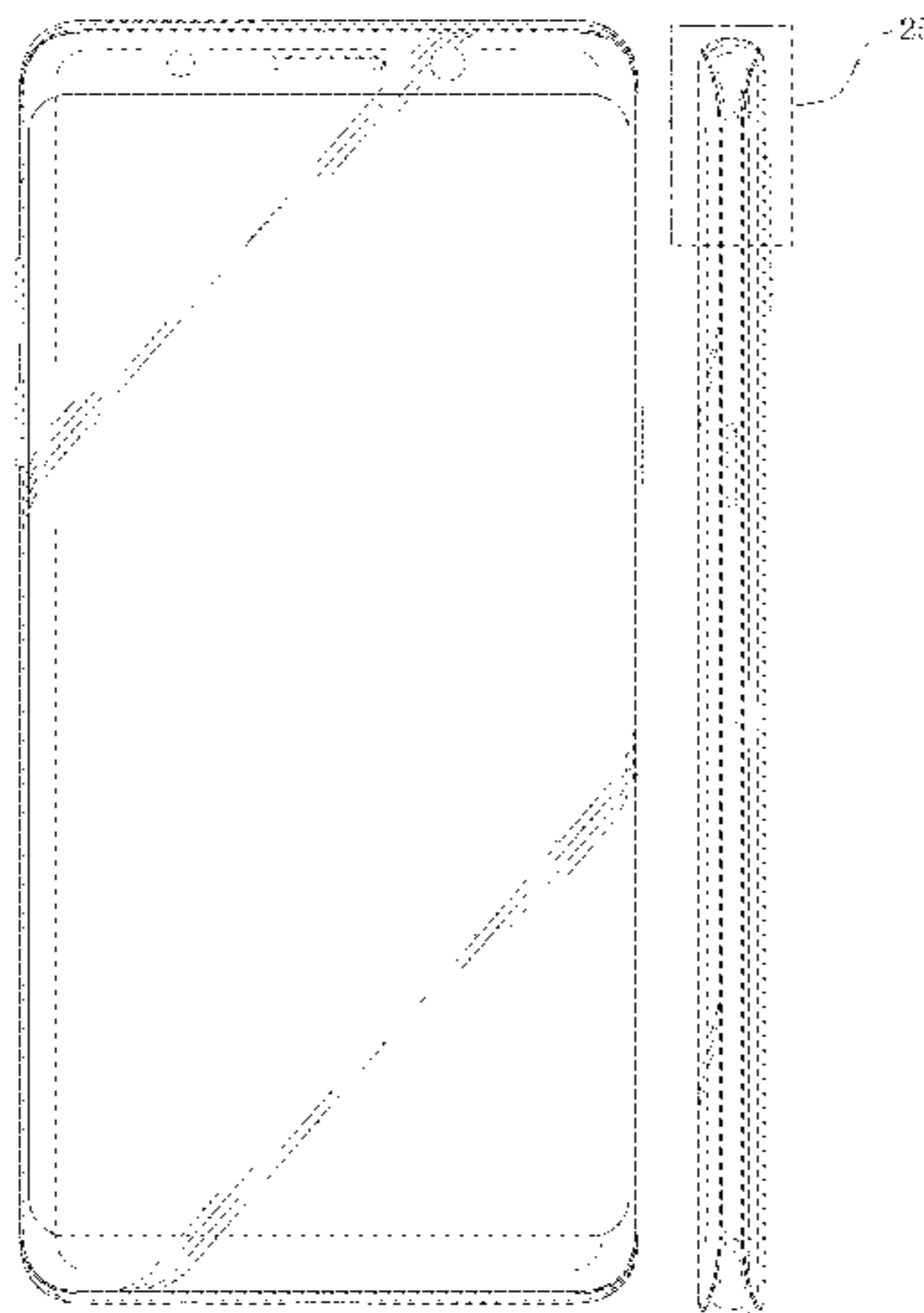

FIG. 25 is an enlarged view of the portion 25 delineated in FIG. 5;

FIG. 26 is an enlarged view of the portion 26 delineated in FIG. 13; and,

FIG. 27 is an enlarged view of the portion 27 delineated in FIG. 21.

The dashed broken lines in the drawings illustrate portions of the electronic device that form no part of the claimed design.

The dot-dash broken lines in FIGS. 5, 13, 21, 25, 26, and 27 delineate portions of the claimed design that are illustrated in enlargements. The dot-dash lines form no part of the claimed design.

1 Claim, 27 Drawing Sheets

(58) **Field of Classification Search**

USPC 455/575.1, 556.2; D21/517, 329;
361/679.3, 679.56

CPC . G06F 1/1626; H04M 1/0266; H04M 1/0202;
H04M 1/026

See application file for complete search history.

(56) **References Cited**

U.S. PATENT DOCUMENTS

D714,768 S * 10/2014 Park D14/248
D715,246 S * 10/2014 Oh D14/138 G
D728,505 S * 5/2015 Chung D14/138 G
D752,036 S * 3/2016 Ho D14/341
D755,148 S * 5/2016 Wu D14/138 G
D767,522 S * 9/2016 Wu D14/138 G
D782,456 S * 3/2017 Park D14/248
D783,567 S * 4/2017 Park D14/138 G
D783,586 S * 4/2017 Park D14/248
D786,848 S * 5/2017 Park D14/248
D786,850 S * 5/2017 Park D14/248
D788,089 S * 5/2017 Park D14/248
D798,853 S * 10/2017 Park D14/248
D800,716 S * 10/2017 Akana D14/341
D801,297 S * 10/2017 Song D14/138 G
D801,322 S * 10/2017 Song D14/248
D801,959 S * 11/2017 Kuo D14/248
D802,553 S * 11/2017 Berneth D14/138 G
9,891,821 B2 * 2/2018 Luo G06F 1/1626
D813,186 S * 3/2018 Lee D14/138 G
D816,649 S * 5/2018 Song D14/248
D817,912 S * 5/2018 Choi D14/138 G
D820,800 S * 6/2018 Song D14/138 G
D821,389 S * 6/2018 Kim D14/341
D824,874 S * 8/2018 You D14/138 G
D825,516 S * 8/2018 Li D14/138 G
D828,820 S * 9/2018 Song D14/138 G
D831,017 S * 10/2018 Choe D14/248
D831,602 S * 10/2018 Ryu D14/138 G
D831,605 S * 10/2018 Baik D14/138 G

D832,835 S * 11/2018 Akana D14/341
D833,407 S * 11/2018 Kim D14/138 G
D834,553 S * 11/2018 Depape D14/138 G
D837,177 S * 1/2019 Cui D14/138 G
D839,848 S * 2/2019 Baik D14/138 G
D843,338 S * 3/2019 Kim D14/138 G
D843,964 S * 3/2019 Forsyth D14/138 G
D849,709 S * 5/2019 Choi D14/138 G
D851,076 S * 6/2019 Mu D14/248
D853,980 S * 7/2019 Kim D14/138 G
D856,958 S * 8/2019 Seo D14/138 G
D856,959 S * 8/2019 Seo D14/138 G
D857,643 S * 8/2019 Choi D14/138 G
2014/0284096 A1 * 9/2014 Wu H05K 5/04
174/520
2016/0028151 A1 * 1/2016 Tsai B21D 5/00
343/702
2016/0041716 A1 * 2/2016 Richardson G06F 3/0488
345/173
2016/0224075 A1 * 8/2016 Chen G06F 1/1656
2017/0125897 A1 * 5/2017 Rubin H01Q 21/28
2017/0133746 A1 * 5/2017 Hahn H01Q 1/243
2018/0070465 A1 * 3/2018 Cater G06F 1/1626
2018/0098448 A1 * 4/2018 Baek H05K 5/0217
2018/0176348 A1 * 6/2018 Bao H04B 1/3827
2018/0198897 A1 * 7/2018 Tang H04N 5/2251
2018/0241857 A1 * 8/2018 Wang H01Q 1/44
2018/0259388 A1 * 9/2018 Oh G01J 1/0437
2018/0366685 A1 * 12/2018 Park H01L 51/5284
2019/0037293 A1 * 1/2019 Kim H04R 1/025
2019/0158641 A1 * 5/2019 Kim H04M 1/0264

OTHER PUBLICATIONS

Samsung Galaxy S9, released Mar. 2018, [online], [site visited Dec. 30, 2018]. Available from Internet, <URL: https://www.gsmarena.com/samsung_galaxy_s9-pictures-8966.php>.*
Samsung Galaxy Note FE, released Jul. 2017, [online], [site visited Dec. 30, 2018]. Available from Internet, <URL: https://www.gsmarena.com/samsung_galaxy_note_fe-8683.php>.*
Samsung Galaxy S Light Luxury, released May 2018, [online], [site visited Dec. 30, 2018]. Available from Internet, <URL: https://www.gsmarena.com/samsung_galaxy_s_light_luxury-pictures-9202.php>.*
Samsung Galaxy S8 Gets Beautiful 3D Render, Courtesy of Designer Kingway Lee, Concept Phones, Jan. 23, 2017 [online], [site visited Jul. 14, 2017]. Retrieved from url:<https://www.concept-phones.com/samsung/samsung-galaxy-s8-beautiful-3d-render-courtesy-designer-kingway-lee/>>.*
Samsung Galaxy S8 shown at Evan Blass' @evleaks Twitter, Mar. 21, 2017, [online], [site visited Jul. 17, 2017]. Retrieved from url <https://twitter.com/evleaks/status/844329793982287873>>.*
Samsung Galaxy Note 7, released Sep. 2016, [online], [site visited Dec. 30, 2018]. Available from Internet, <URL: https://www.gsmarena.com/samsung_galaxy_note7-pictures-8082.php>.*
Samsung Galaxy Note 8, released Sep. 2017, [online], [site visited Dec. 30, 2018]. Available from Internet, <URL: https://www.gsmarena.com/samsung_galaxy_note8-pictures-8505.php>.*

* cited by examiner

FIG. 1

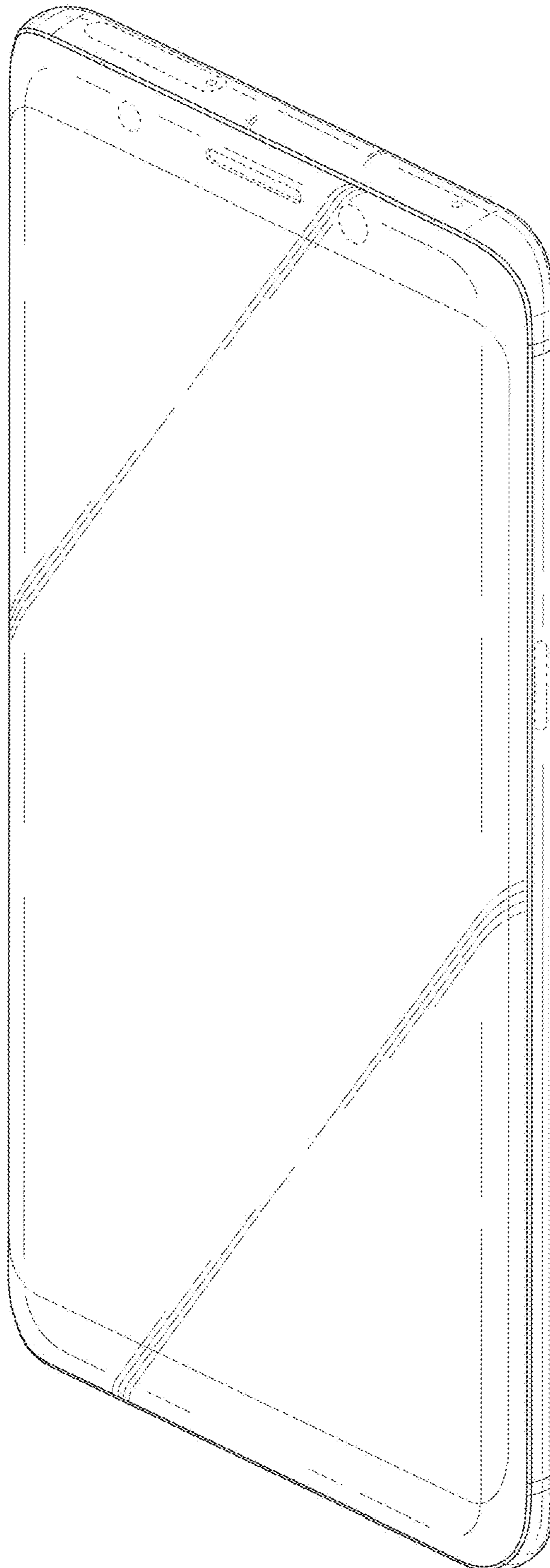

FIG. 2

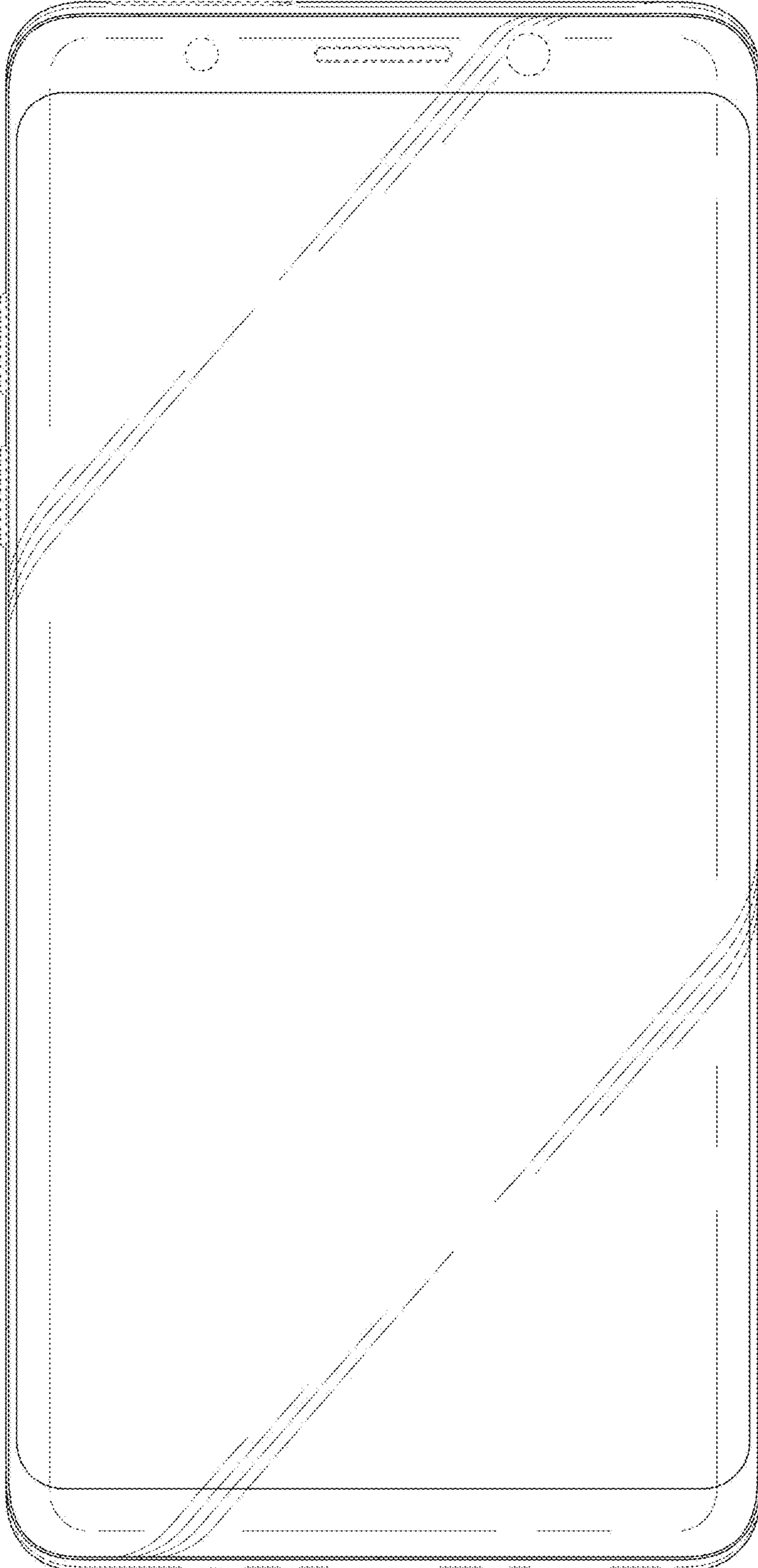

FIG. 3

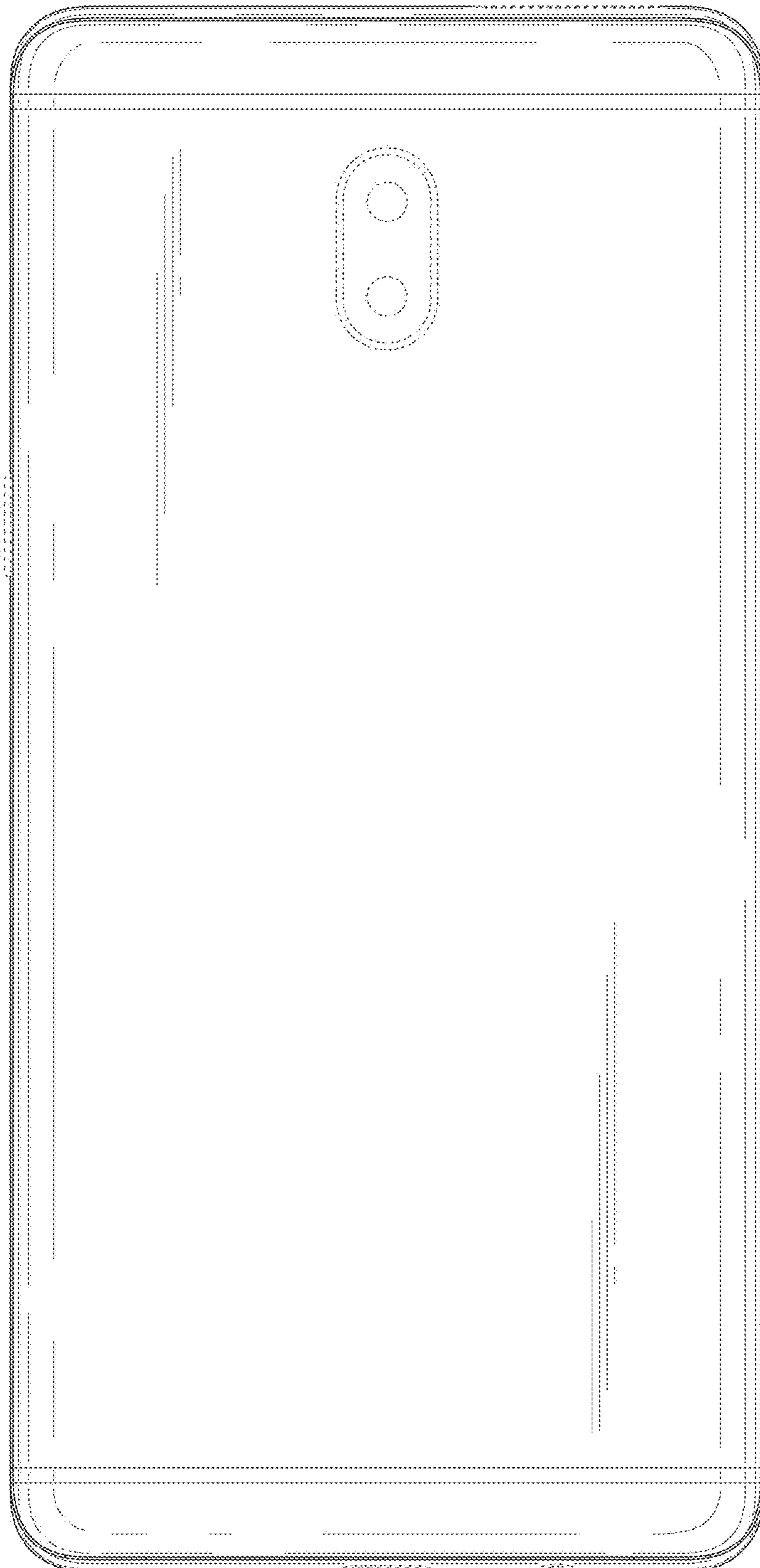

FIG. 4

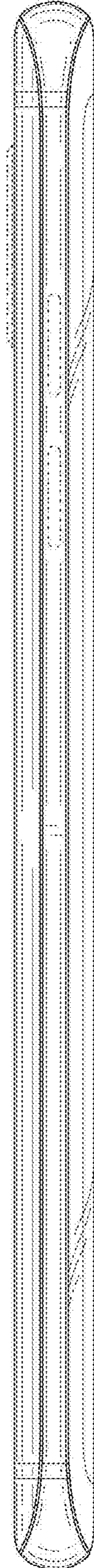

FIG. 5

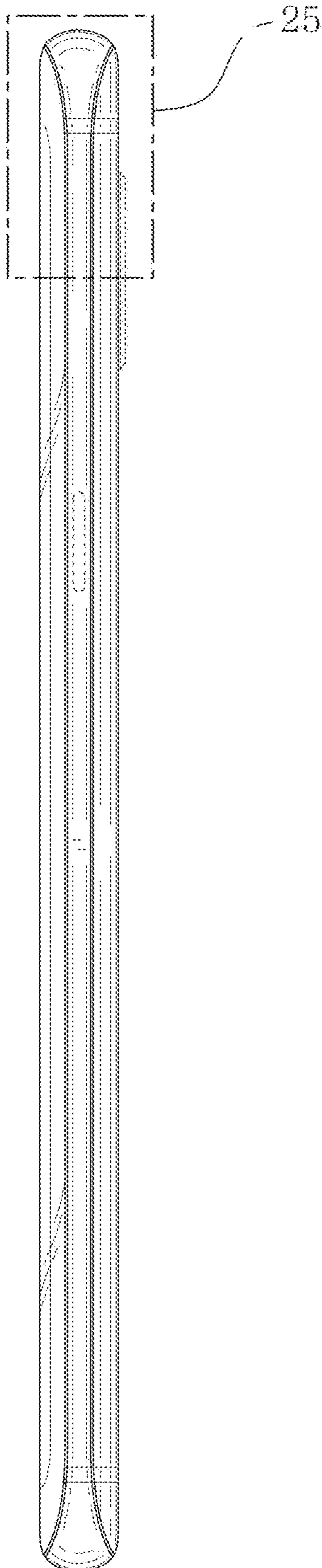

FIG. 6

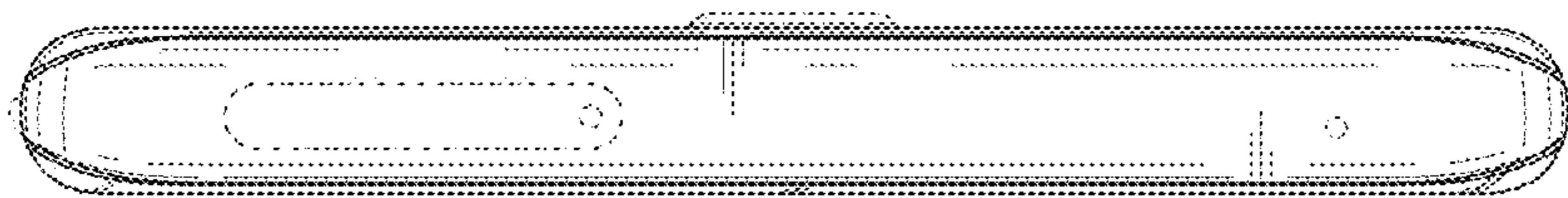

FIG. 7

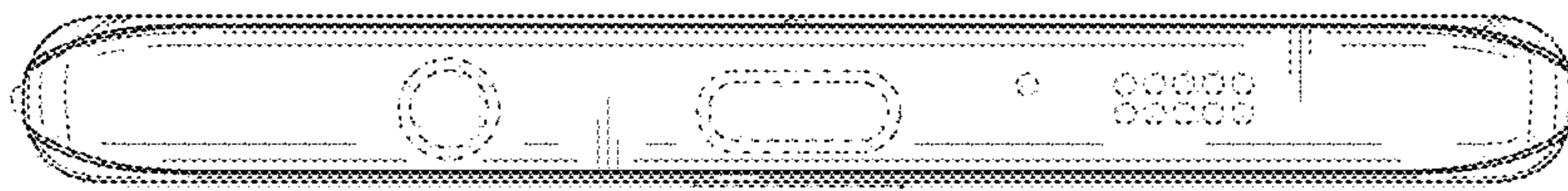

FIG. 8



FIG. 9

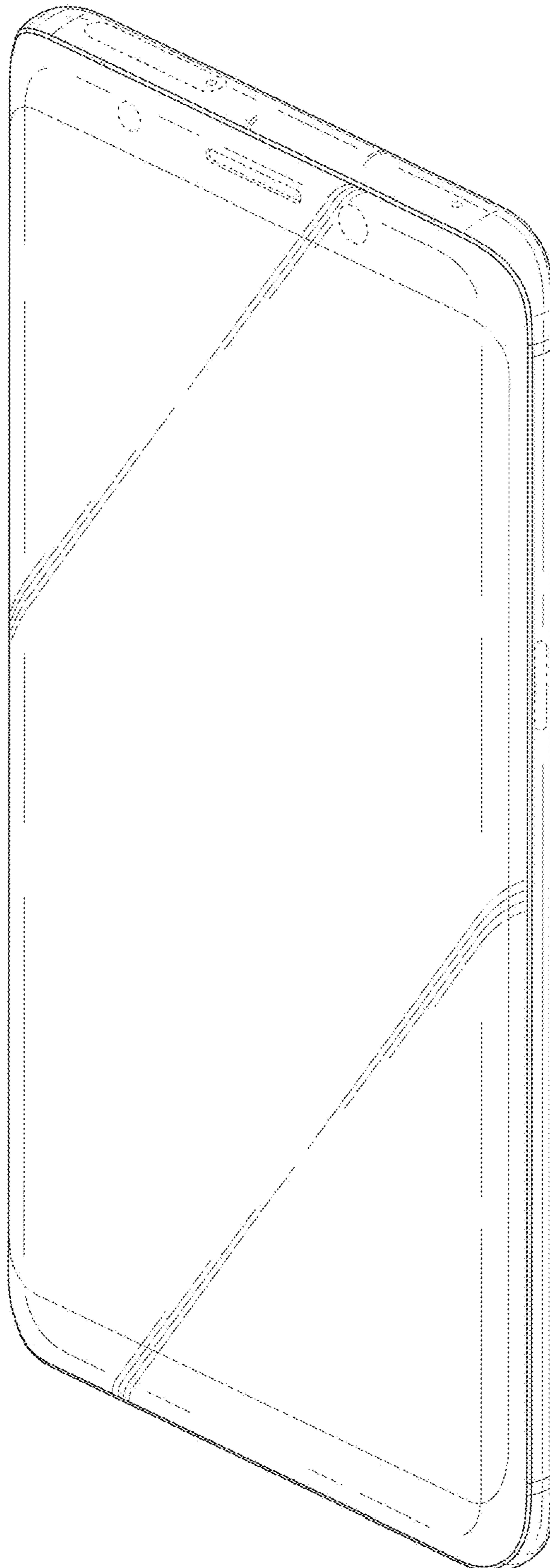

FIG. 10

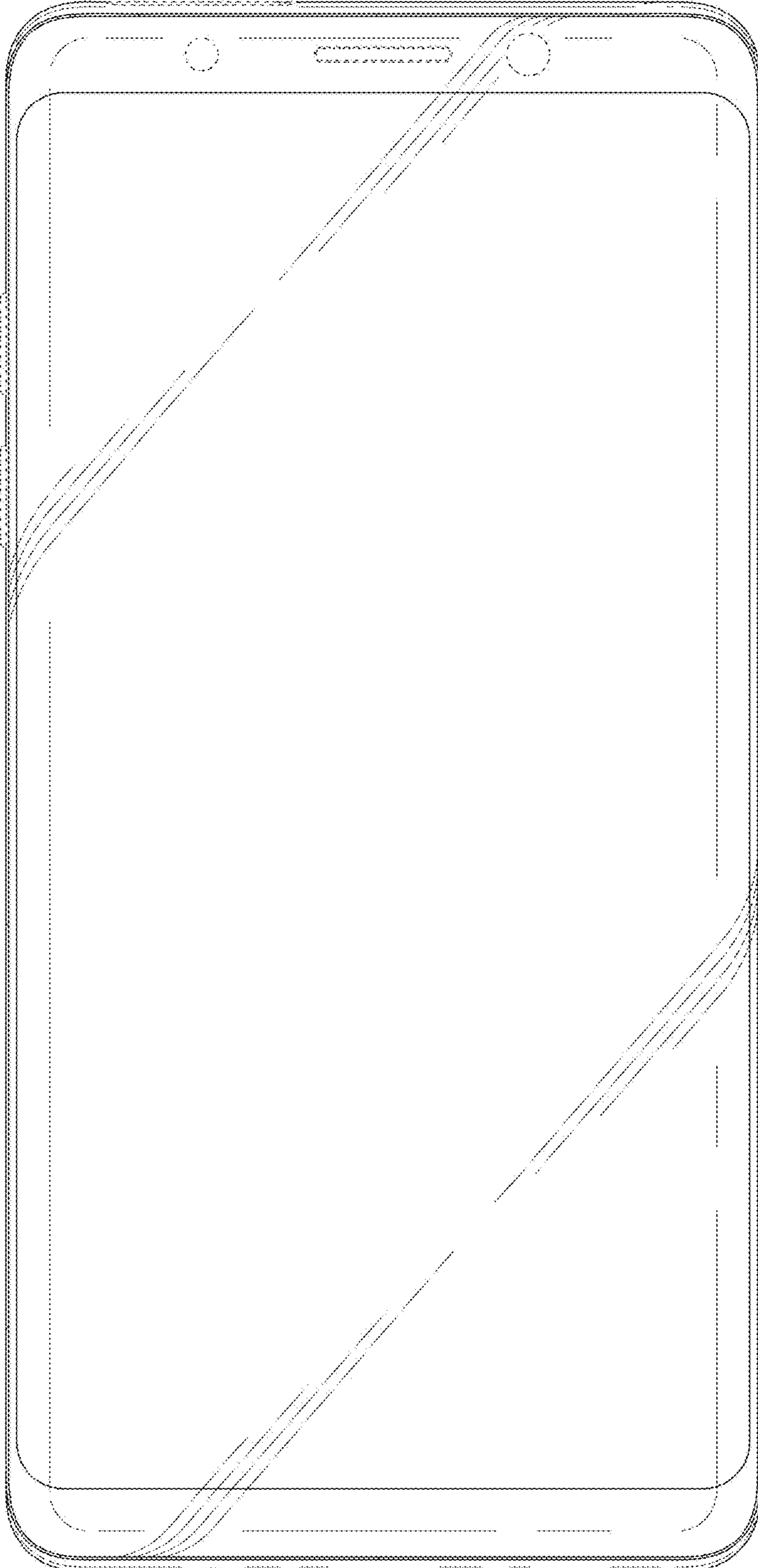

FIG. 11

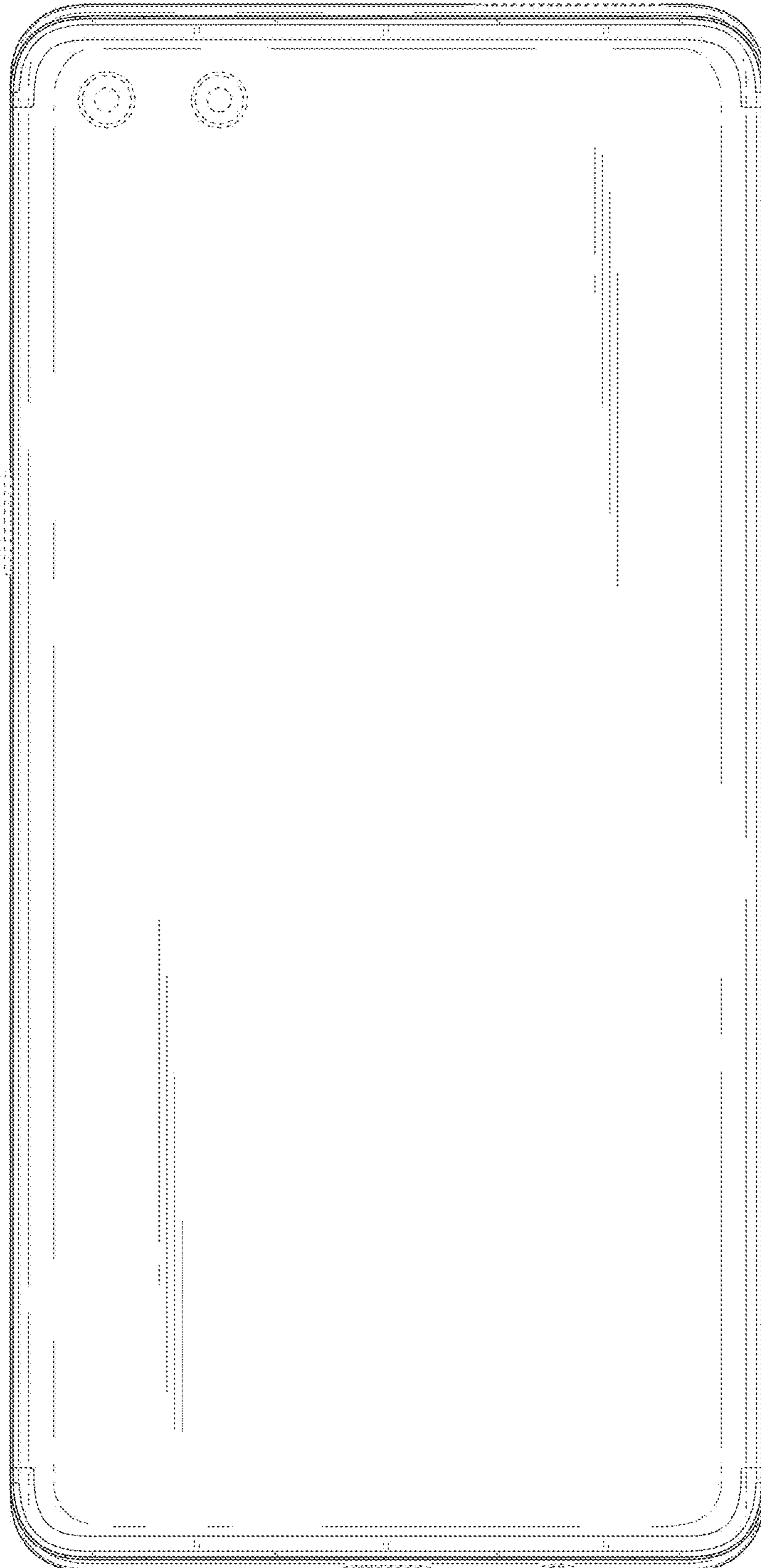

FIG. 12

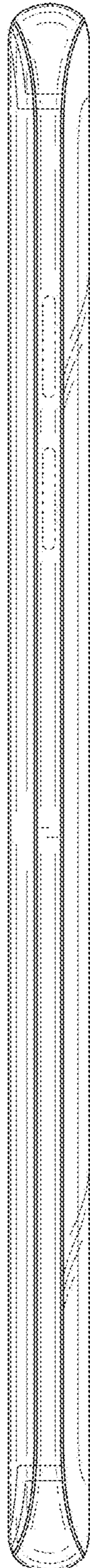

FIG. 13

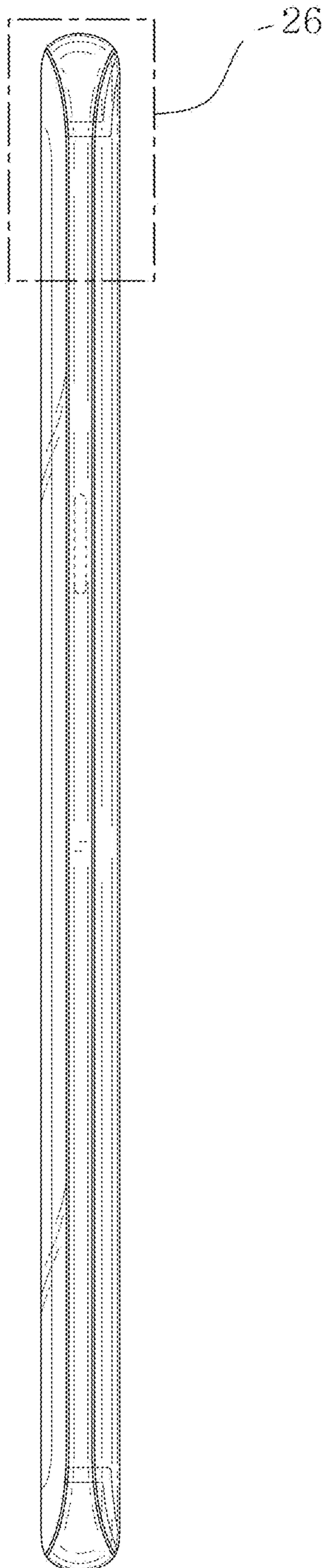

FIG. 14

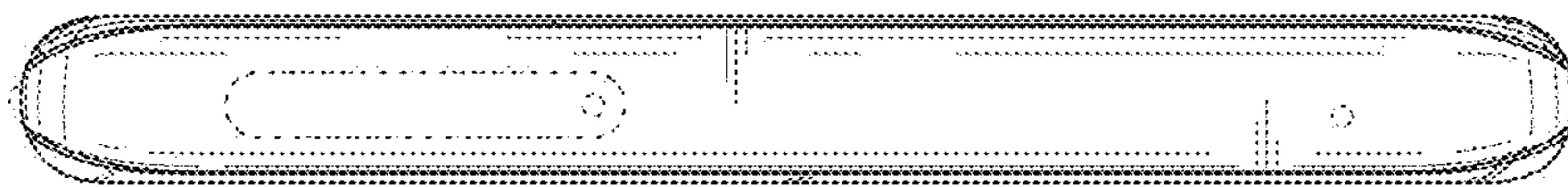

FIG. 15

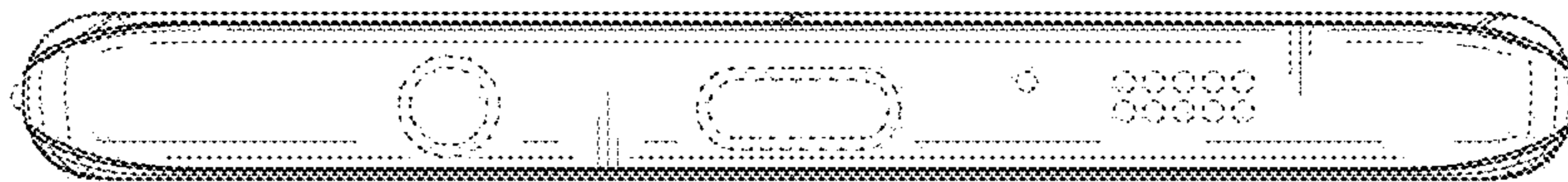

FIG. 16



FIG. 17

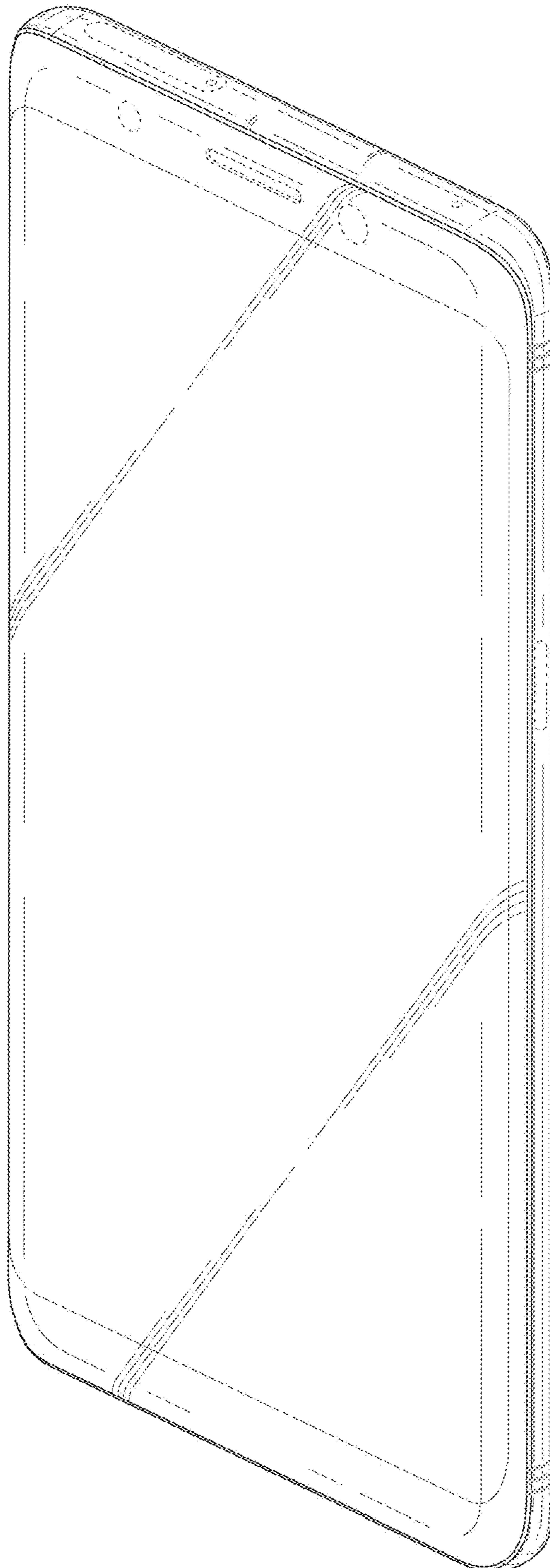

FIG. 18

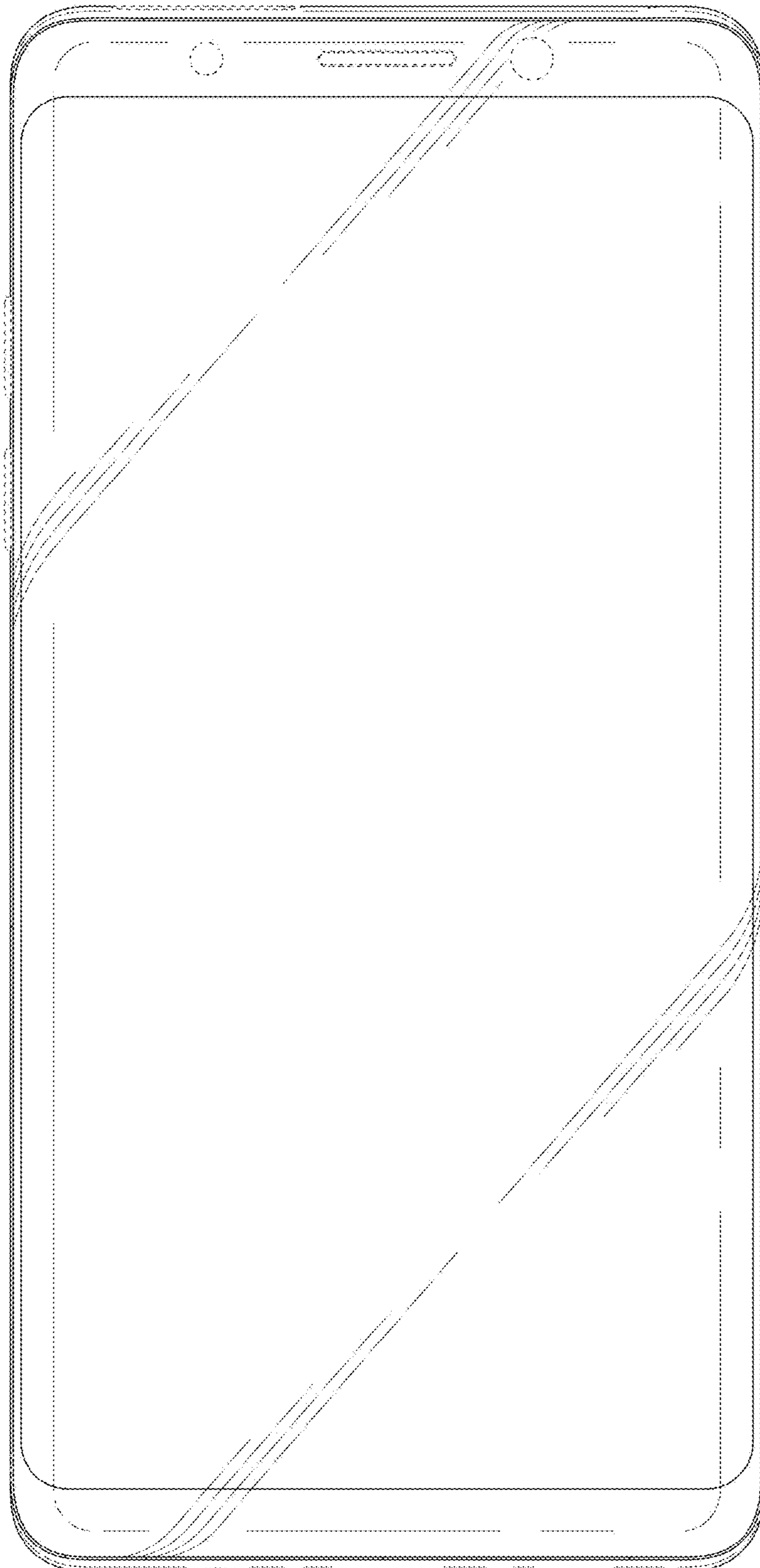

FIG. 19

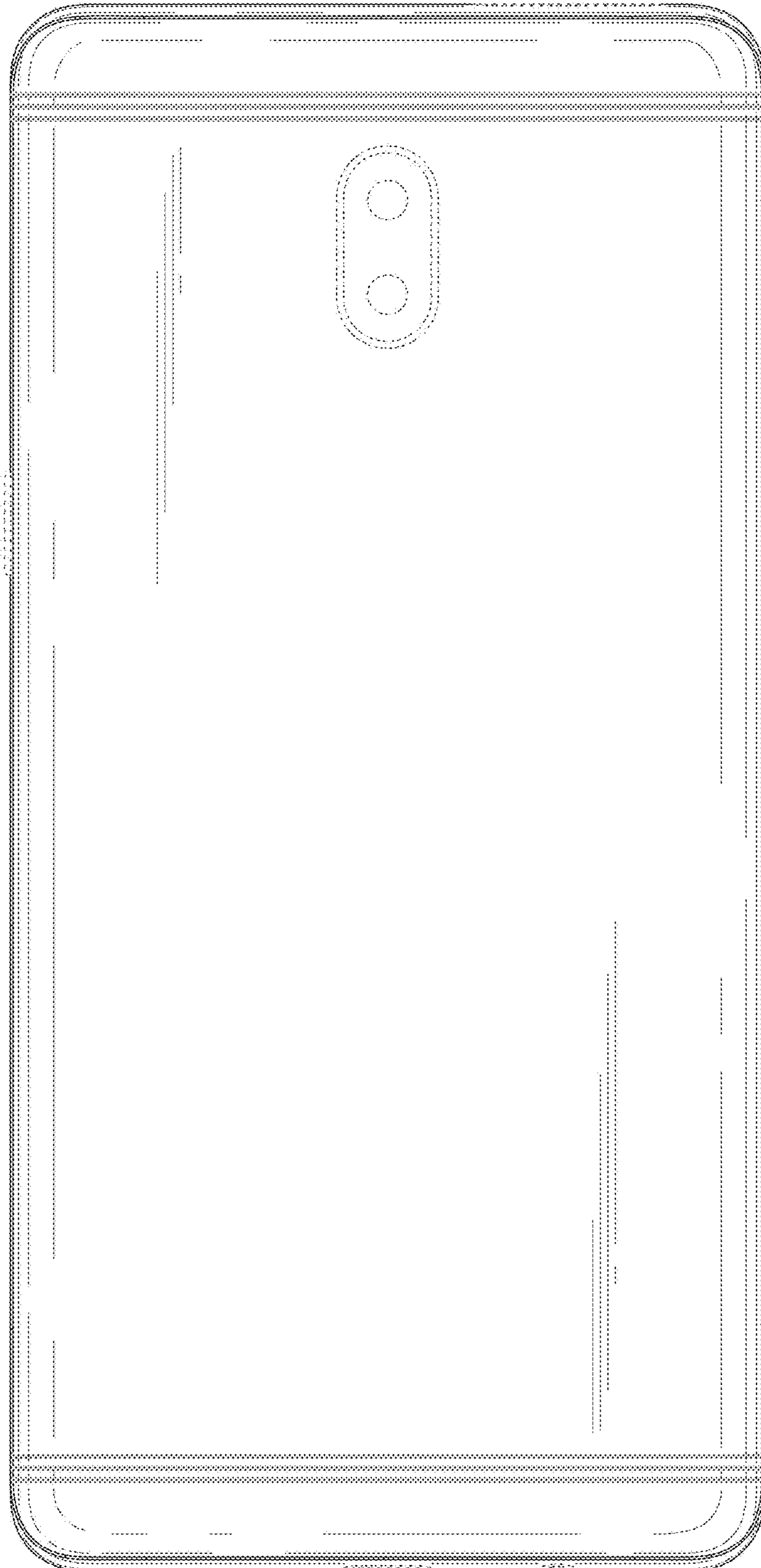

FIG. 20

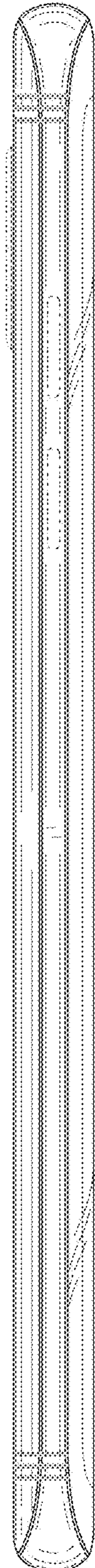

FIG. 21

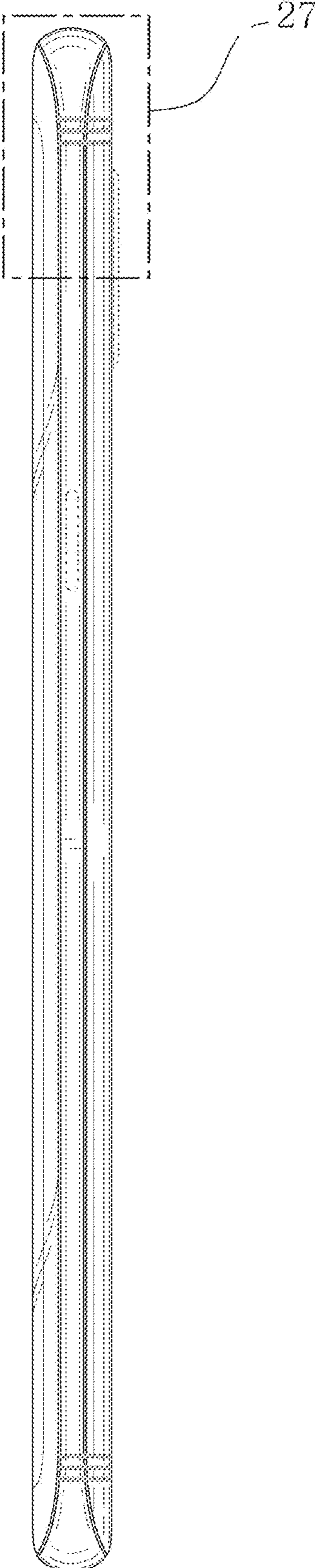

FIG. 22

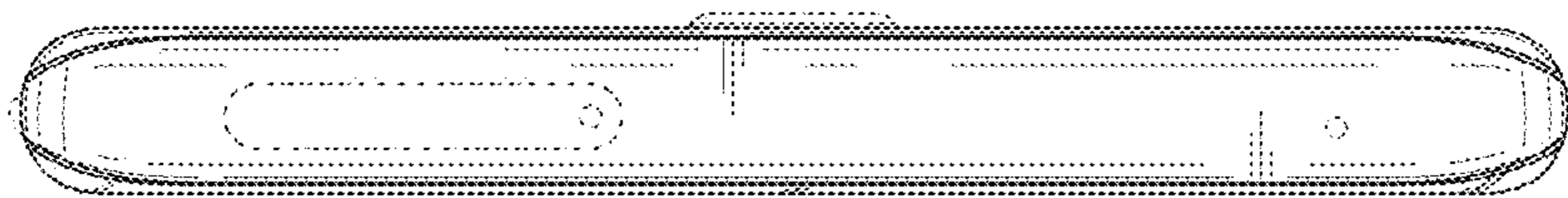

FIG. 23

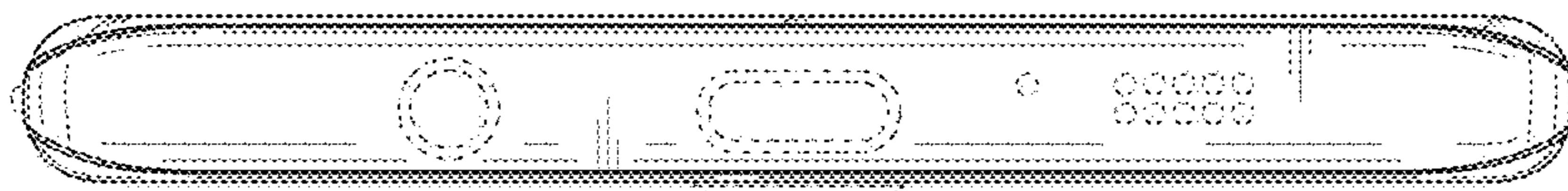

FIG. 24

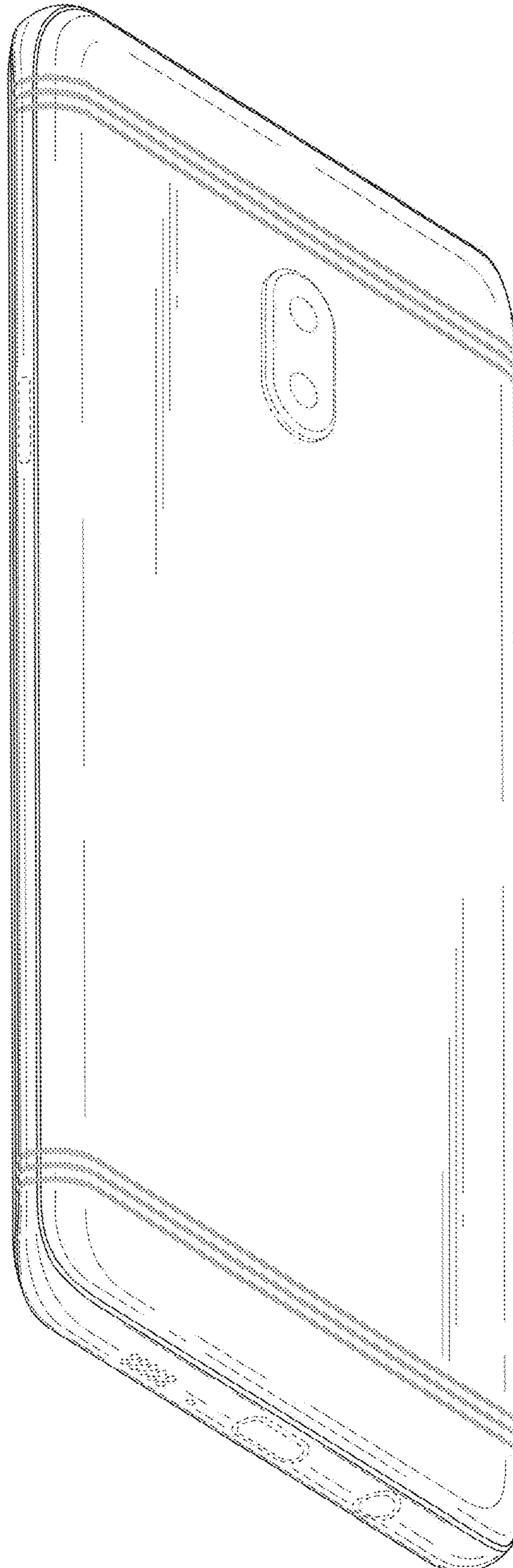

FIG. 25

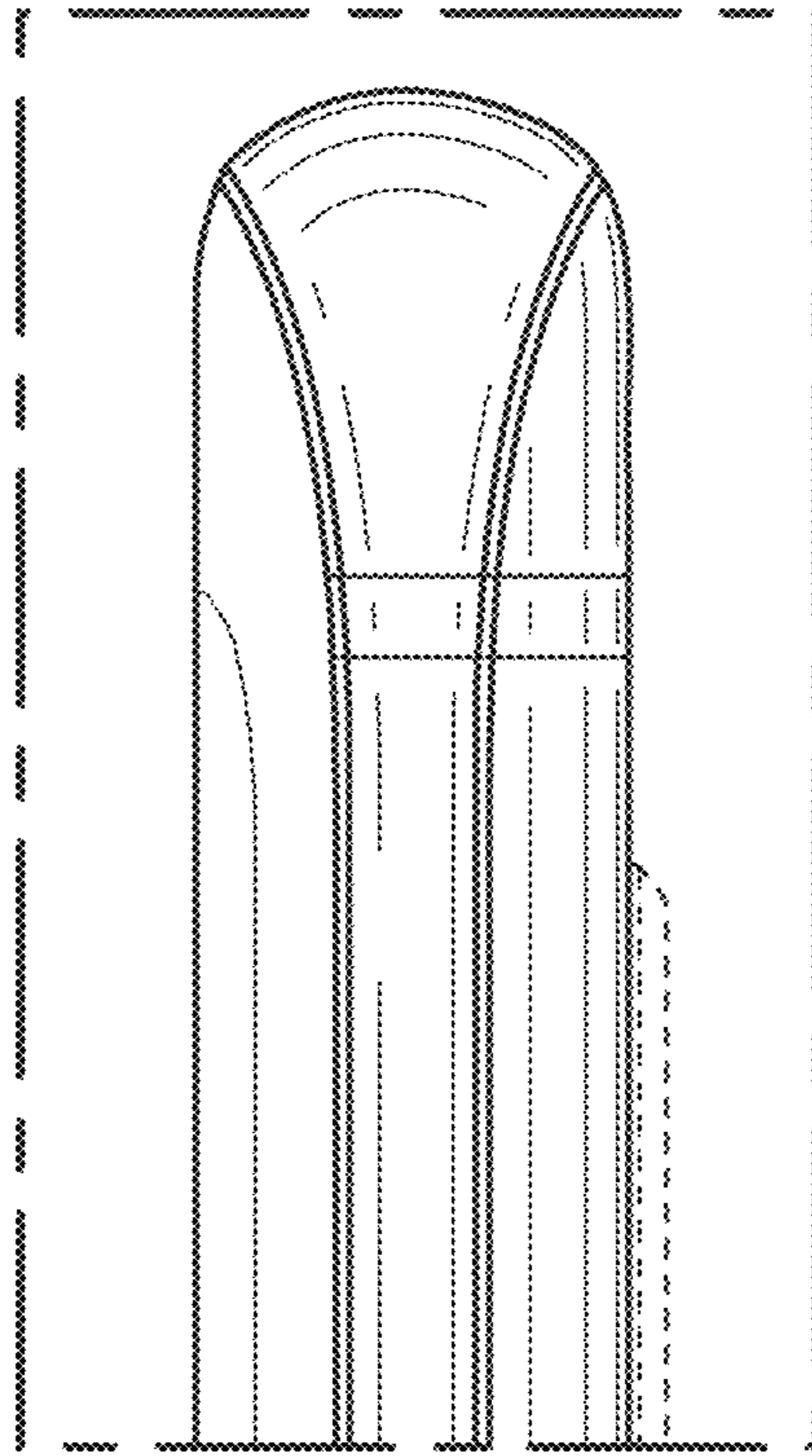

FIG. 26

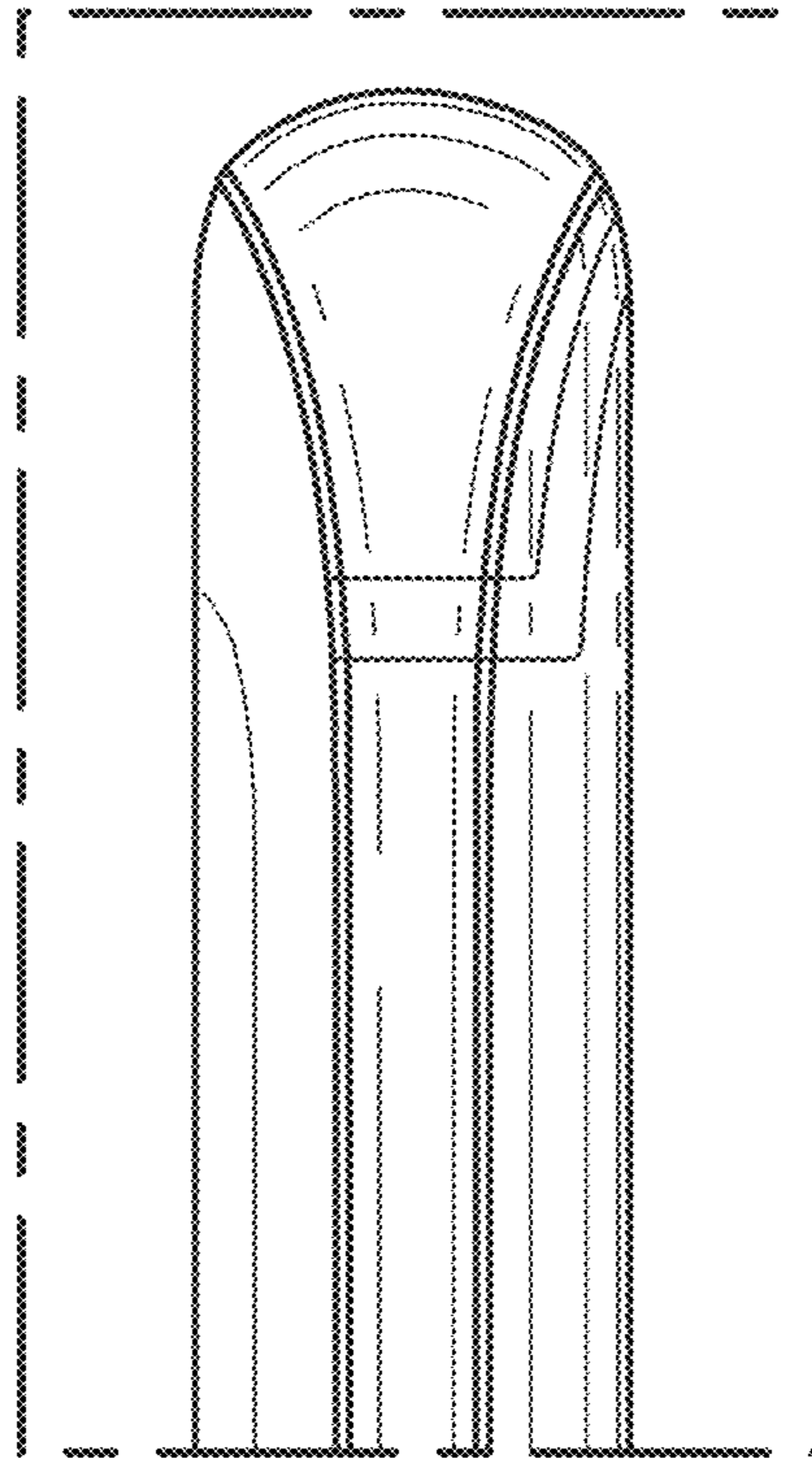

FIG. 27

