



US00D872410S

(12) **United States Design Patent** (10) **Patent No.:** **US D872,410 S**
DiPaolo et al. (45) **Date of Patent:** **** Jan. 7, 2020**

(54) **BAR**
(71) Applicant: **MARS, INCORPORATED**, McLean, VA (US)
(72) Inventors: **Richard DiPaolo**, Hackettstown, NJ (US); **Timothy B. Pender**, Andover, NJ (US)
(73) Assignee: **MARS, INCORPORATED**, McLean, VA (US)
(**) Term: **15 Years**
(21) Appl. No.: **29/686,684**
(22) Filed: **Apr. 5, 2019**

D376,461 S	12/1996	Graf	
D381,176 S	7/1997	Patois et al.	
D385,078 S	10/1997	Thom, Jr.	
5,894,801 A	4/1999	Ackley, Jr.	
D608,973 S	1/2010	Kanda et al.	
8,269,958 B2	9/2012	Ackley, Jr. et al.	
9,327,915 B1	5/2016	Sammauro	
D784,647 S	4/2017	DiPaolo et al.	
D850,053 S *	5/2019	DiPaolo	D34/29
2001/0039889 A1	11/2001	Ackley, Jr.	
2004/0094050 A1	5/2004	Ackley, Jr. et al.	
2009/0250322 A1	10/2009	Jager	
2010/0035739 A1	2/2010	Gysi et al.	
2010/0038215 A1	2/2010	Broe	
2011/0128557 A1	6/2011	Kinoshita et al.	
2011/0128577 A1	6/2011	Miyata	
2011/0297590 A1	12/2011	Ackley, Jr. et al.	

Related U.S. Application Data

(62) Division of application No. 29/593,431, filed on Feb. 8, 2017, now Pat. No. Des. 850,053, which is a division of application No. 29/520,800, filed on Mar. 18, 2015, now Pat. No. Des. 784,647.
(51) **LOC (12) Cl.** **12-05**
(52) **U.S. Cl.**
USPC **D34/29**
(58) **Field of Classification Search**
USPC D34/29, 35; 198/938, 935, 942, 843, 198/844.1
CPC B65G 47/66; B65G 2201/02; B65G 21/22; B65G 23/00; B65G 23/04; B65G 15/08
See application file for complete search history.

FOREIGN PATENT DOCUMENTS

JP H07-081050 A 3/1995

* cited by examiner

Primary Examiner — Cynthia Ramirez

(57) **CLAIM**

The ornamental design for a bar, as shown and described.

DESCRIPTION

FIG. 1 is a perspective view of a bar showing our new design;
FIG. 2 is a front view of the design shown in FIG. 1;
FIG. 3 is a rear view of the design shown in FIG. 1;
FIG. 4 is a left side view of the design shown in FIG. 1;
FIG. 5 is a right side view of the design shown in FIG. 1;
FIG. 6 is a top view of the design shown in FIG. 1; and,
FIG. 7 is a bottom view of the design shown in FIG. 1.
The broken lines shown in the drawings represent unclaimed portions of the bar and form no part of the claims design.

1 Claim, 6 Drawing Sheets

(56) **References Cited**
U.S. PATENT DOCUMENTS
5,074,407 A 12/1991 Brumby
D325,277 S 4/1992 Abbestam et al.

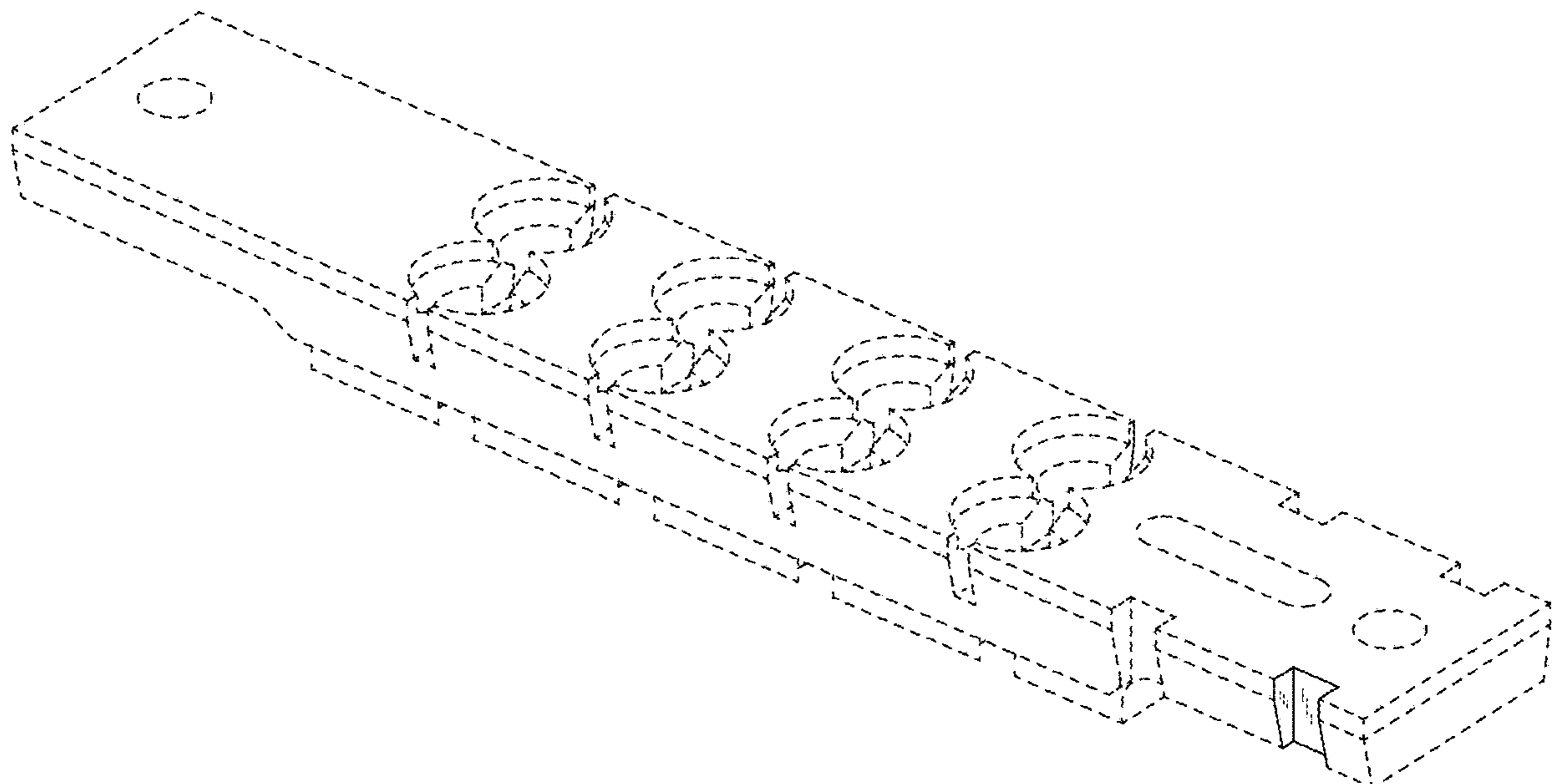

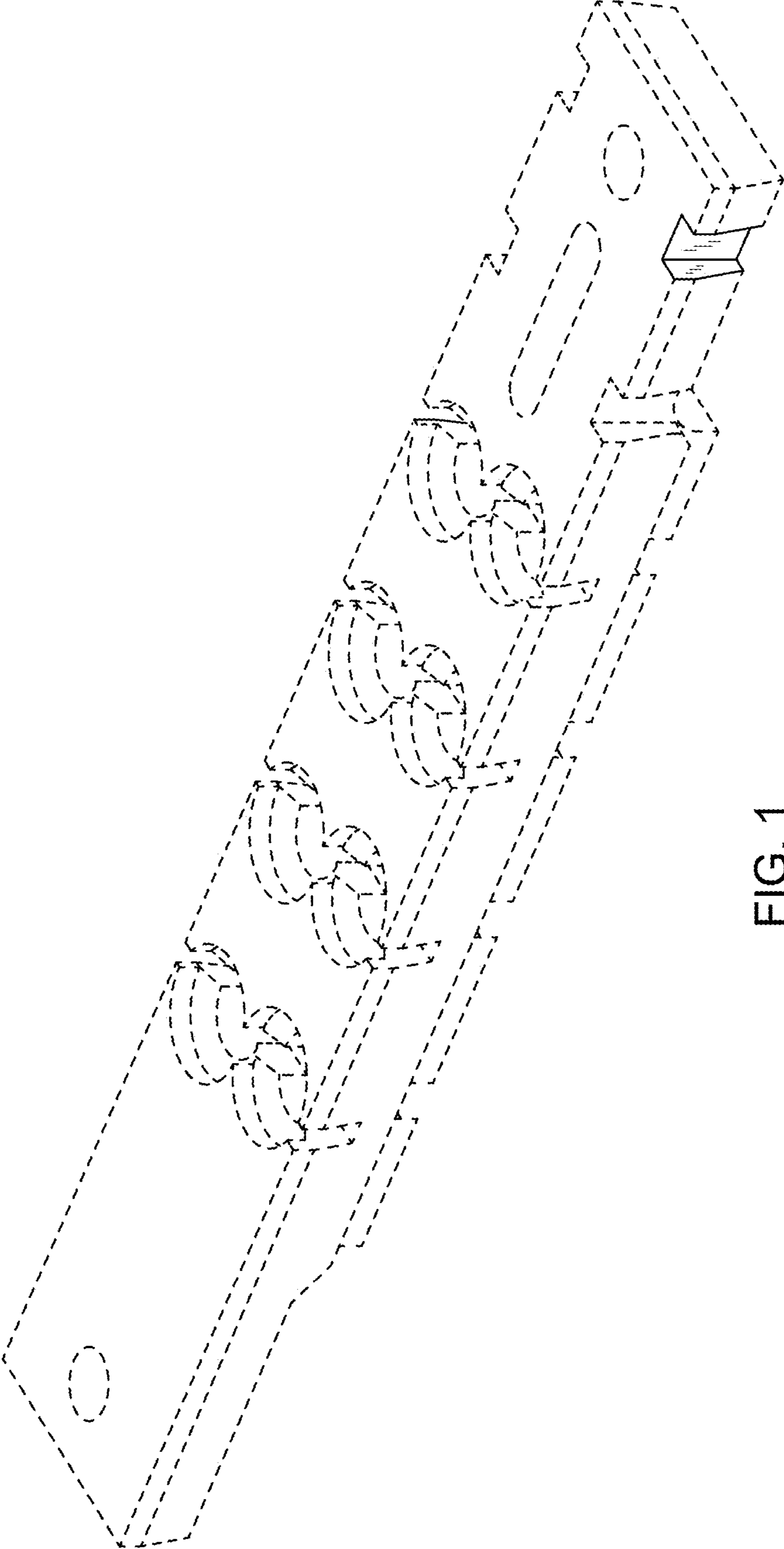

FIG. 1

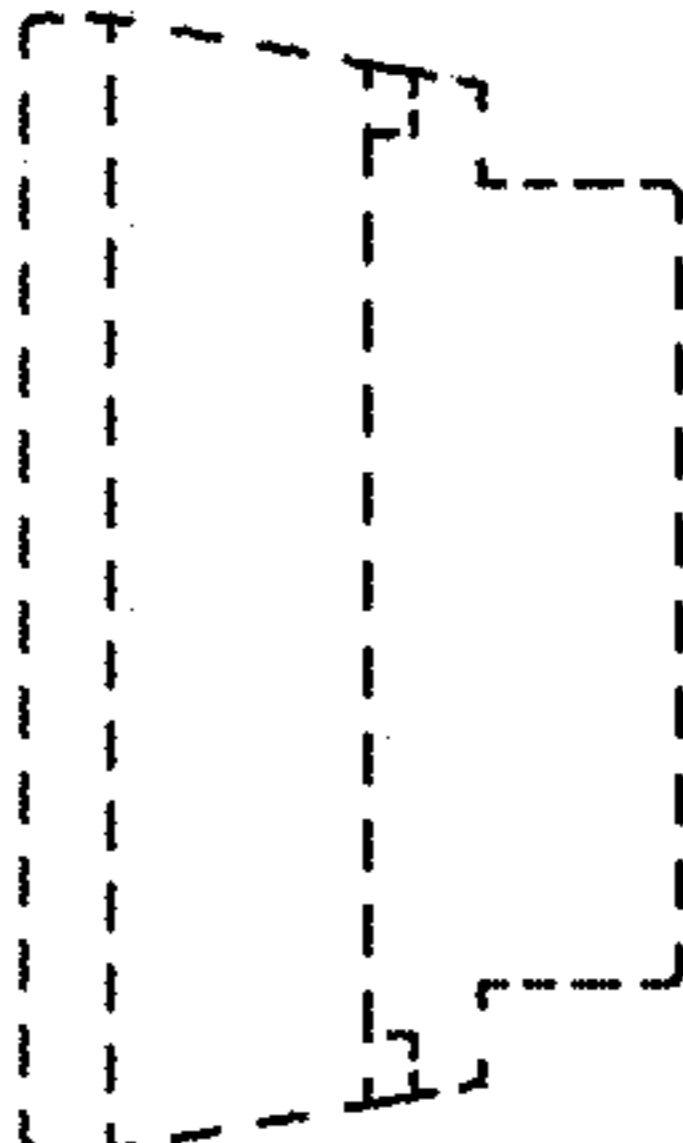

FIG. 2

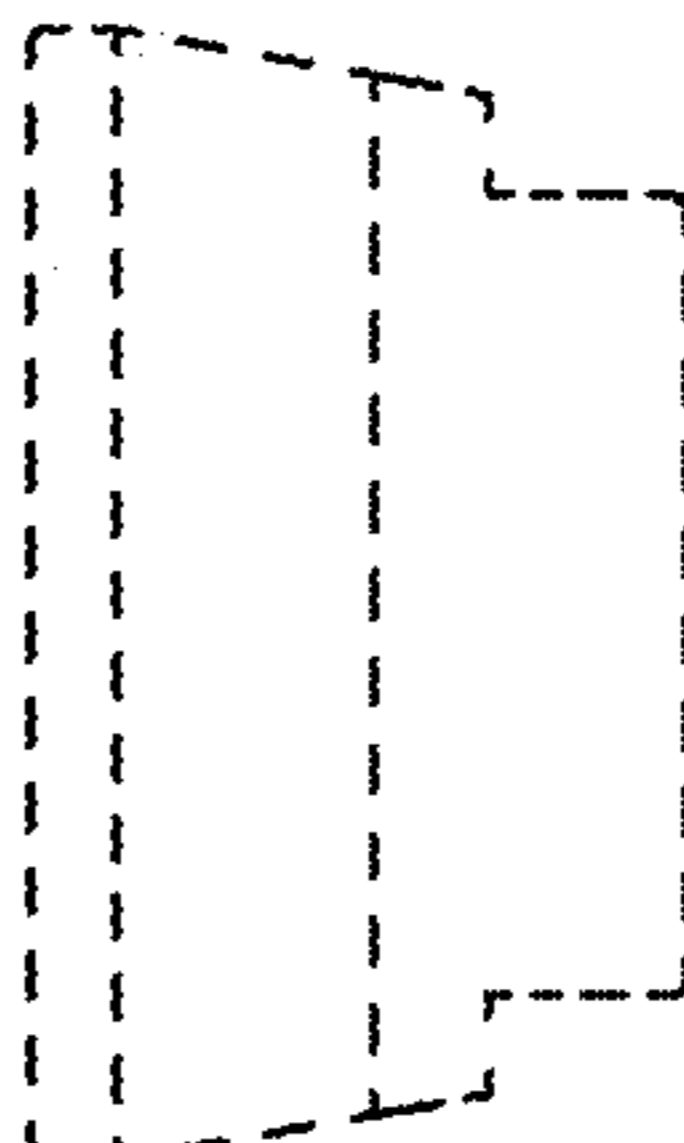

FIG. 3

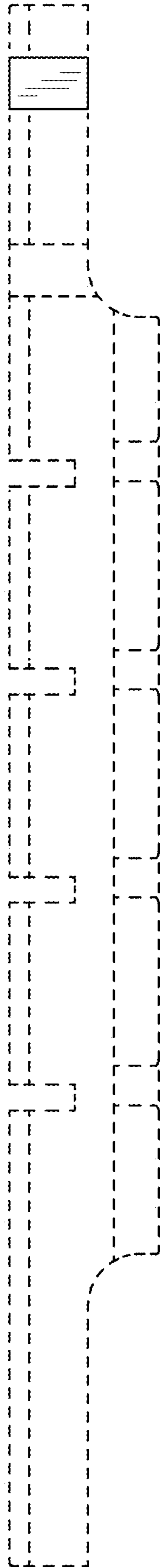

FIG. 4

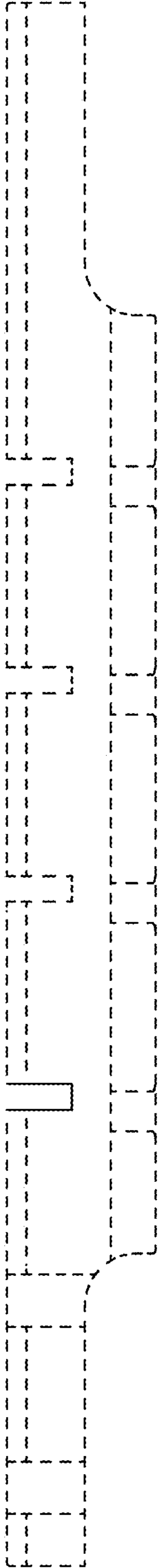

FIG. 5

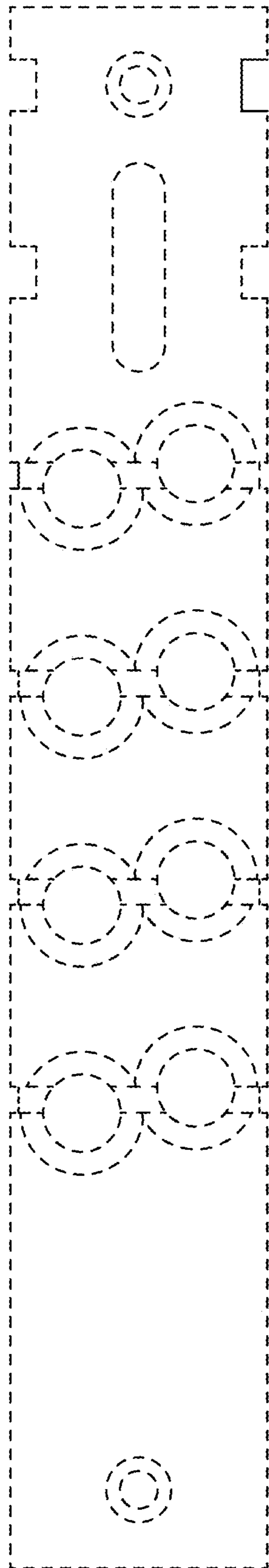

FIG. 6

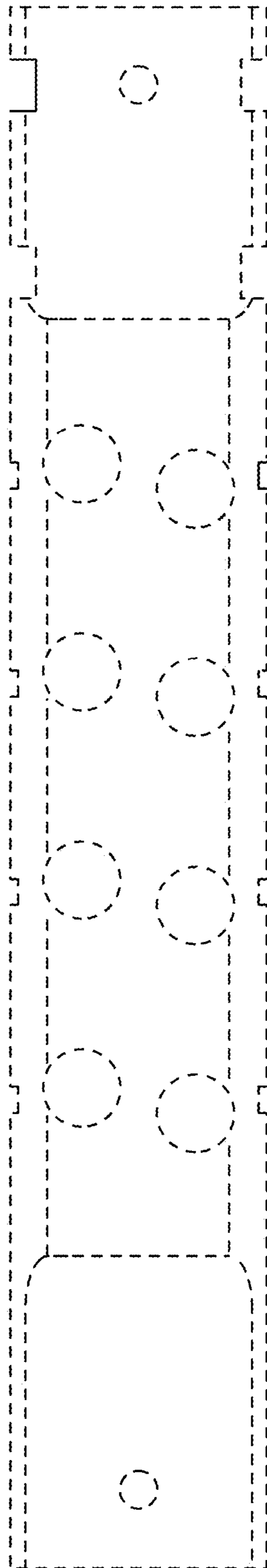

FIG. 7