



US00D872393S

(12) **United States Design Patent**
Xiao

(10) **Patent No.:** **US D872,393 S**

(45) **Date of Patent:** **** Jan. 7, 2020**

- (54) **SHOE DRYER**
- (71) Applicant: **Xiaoping Xiao**, Guangzhou (CN)
- (72) Inventor: **Xiaoping Xiao**, Guangzhou (CN)
- (**) Term: **15 Years**
- (21) Appl. No.: **29/620,610**
- (22) Filed: **Mar. 15, 2017**
- (51) **LOC (12) Cl.** **15-05**
- (52) **U.S. Cl.**
USPC **D32/8; D15/199**
- (58) **Field of Classification Search**
USPC D15/122, 199; D32/1, 8, 14.1, 25,
D32/55-57, 58-59
CPC A47K 10/06; A47L 23/20; A47L 23/205;
F26B 21/006
See application file for complete search history.

- 6,766,594 B2 * 7/2004 DuRapau A47L 23/205
34/104
- D496,502 S * 9/2004 Cheng D32/1
- 7,043,854 B2 * 5/2006 Peet A47L 23/205
34/104
- D565,260 S * 3/2008 Lam D32/8
- 7,469,487 B2 * 12/2008 Macher A47L 23/205
34/104
- 7,526,876 B2 * 5/2009 Carey A47L 23/205
34/103
- D653,007 S * 1/2012 Beckett D32/8
- D776,885 S * 1/2017 Schaberreiter D32/8
- 2011/0000098 A1 * 1/2011 Karafinka A47L 23/205
34/202
- 2018/0078113 A1 * 3/2018 Nurlybekov A47L 23/205

* cited by examiner

Primary Examiner — Patricia A Palasik
(74) *Attorney, Agent, or Firm* — Richard A. Castellano;
DNL Zito Castellano

(56) **References Cited**

U.S. PATENT DOCUMENTS

- D113,493 S * 2/1939 Harrison D32/8
- 3,203,112 A * 8/1965 Edmonds A43D 95/02
34/104
- 4,198,765 A * 4/1980 Miyamae A47L 23/205
34/104
- 4,787,153 A * 11/1988 Chen A47L 23/205
219/521
- 4,908,957 A * 3/1990 Acosta, Sr. A47L 23/20
34/86
- 5,058,289 A * 10/1991 Guindon A47L 23/205
34/104
- 5,165,181 A * 11/1992 Acosta, Sr. A47L 23/205
34/104
- 5,199,188 A * 4/1993 Franz A47L 23/205
34/104
- 5,894,680 A * 4/1999 Dalvy A43B 7/28
34/104
- 6,766,591 B1 * 7/2004 McKinney A47L 23/205
34/104

(57) **CLAIM**

The ornamental design for a shoe dryer, as shown and described.

DESCRIPTION

FIG. 1 is a front view of a shoe dryer showing my new design in accordance with an embodiment;
FIG. 2 is a back view of the shoe dryer of FIG. 1;
FIG. 3 is a left side view of the shoe dryer;
FIG. 4 is a right side view of the shoe dryer;
FIG. 5 is a top view of the shoe dryer;
FIG. 6 is a bottom view of the shoe dryer;
FIG. 7 is a right side, front perspective view of the shoe dryer;
FIG. 8 is a right side, front perspective view of the shoe dryer in a first open configuration; and,
FIG. 9 is a right side, front perspective view of the shoe dryer in a second open configuration.

1 Claim, 9 Drawing Sheets

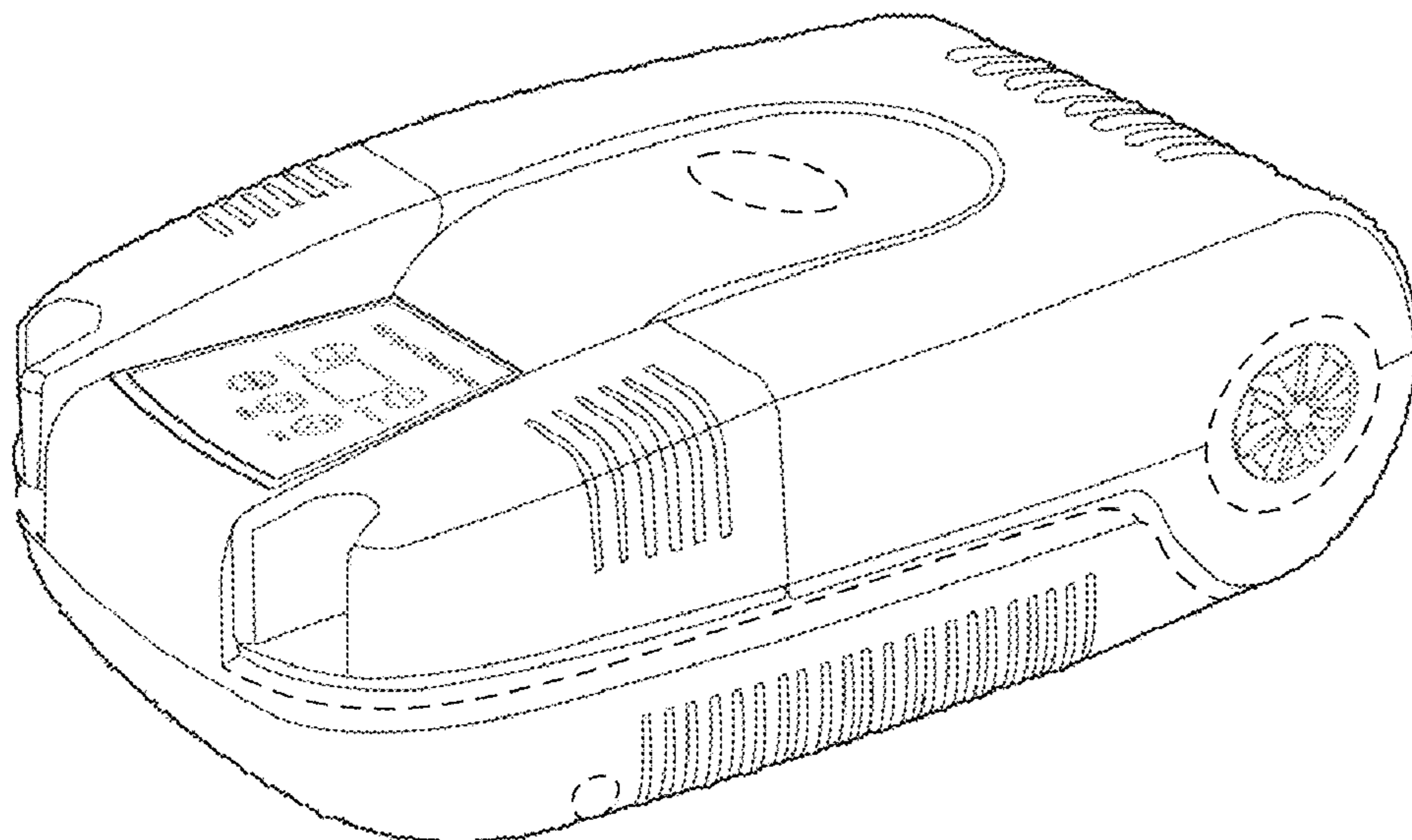

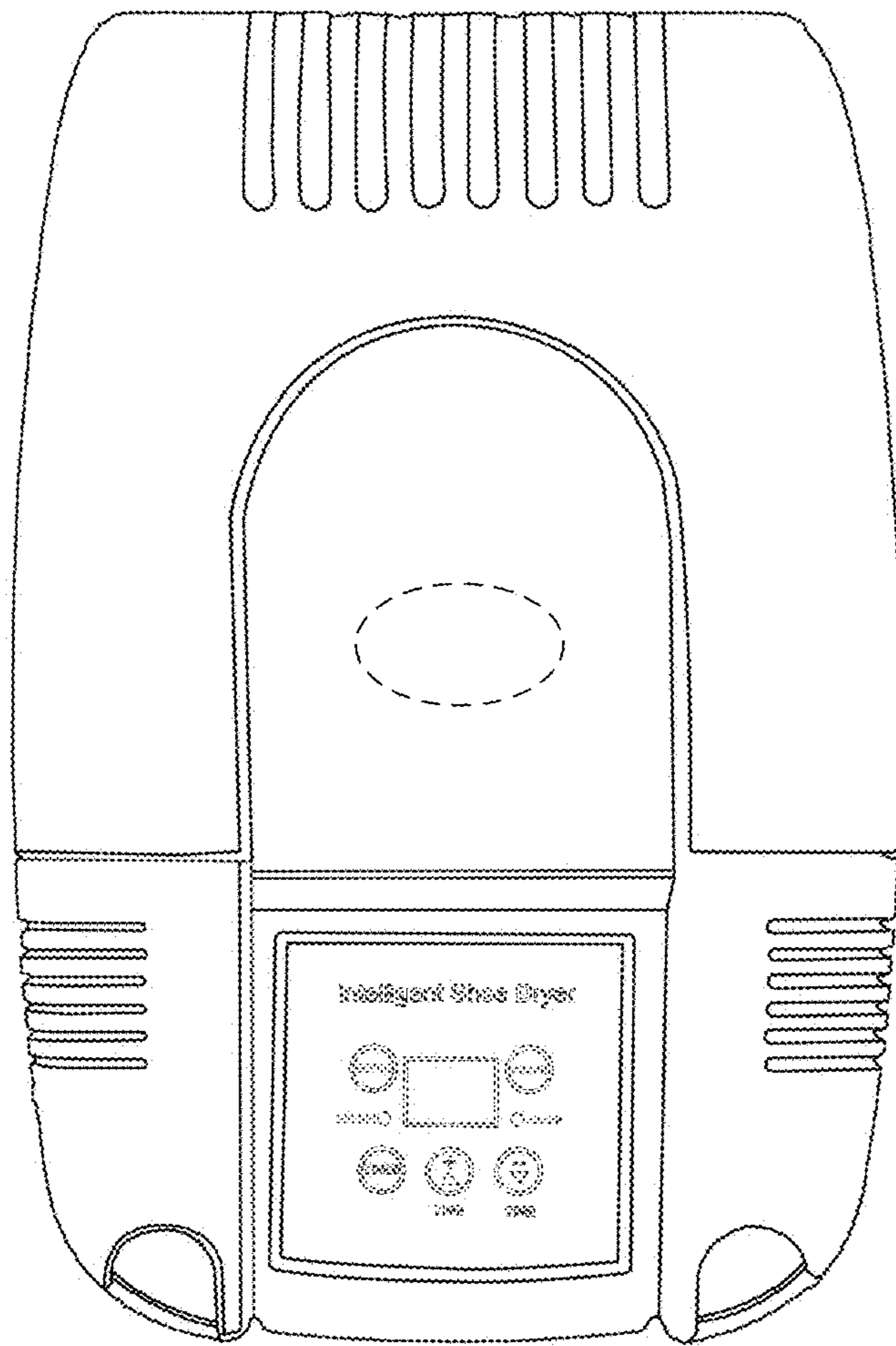

FIG. 1

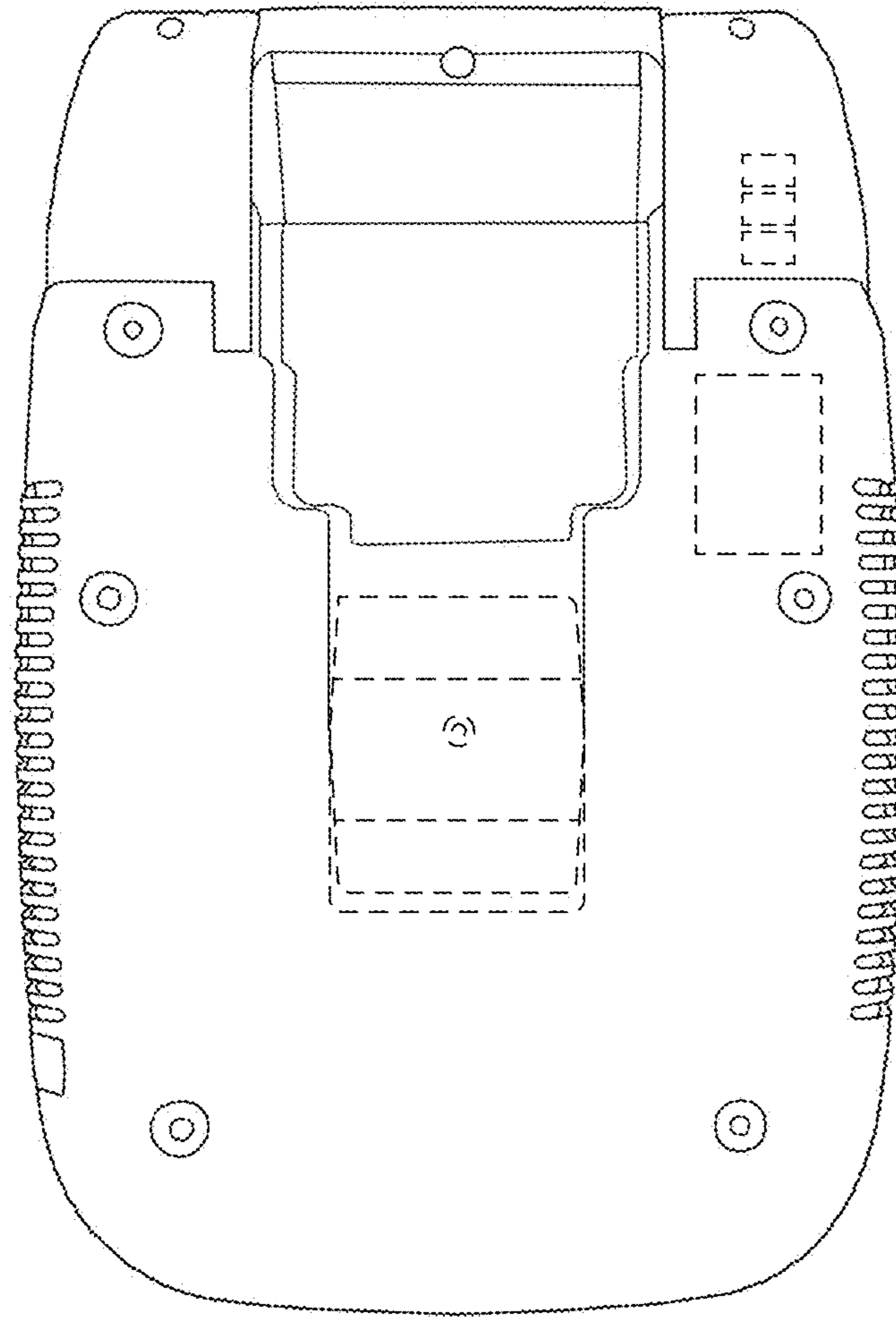

FIG. 2

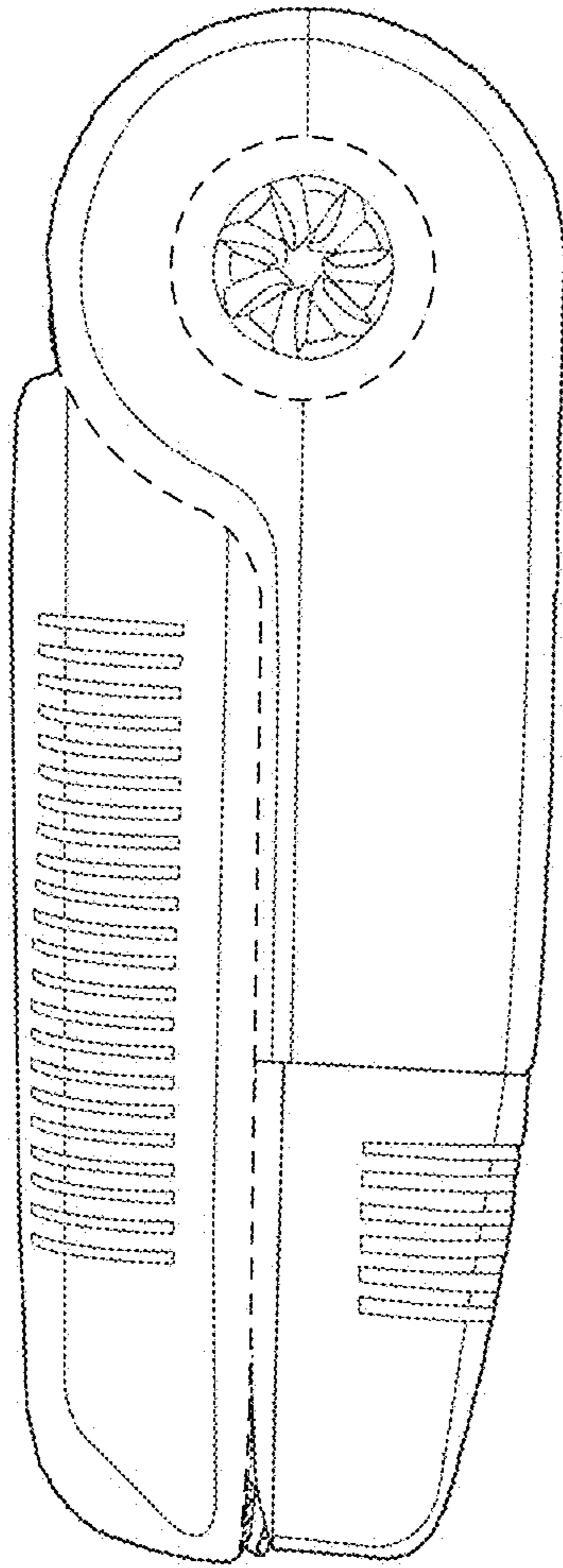

FIG. 3

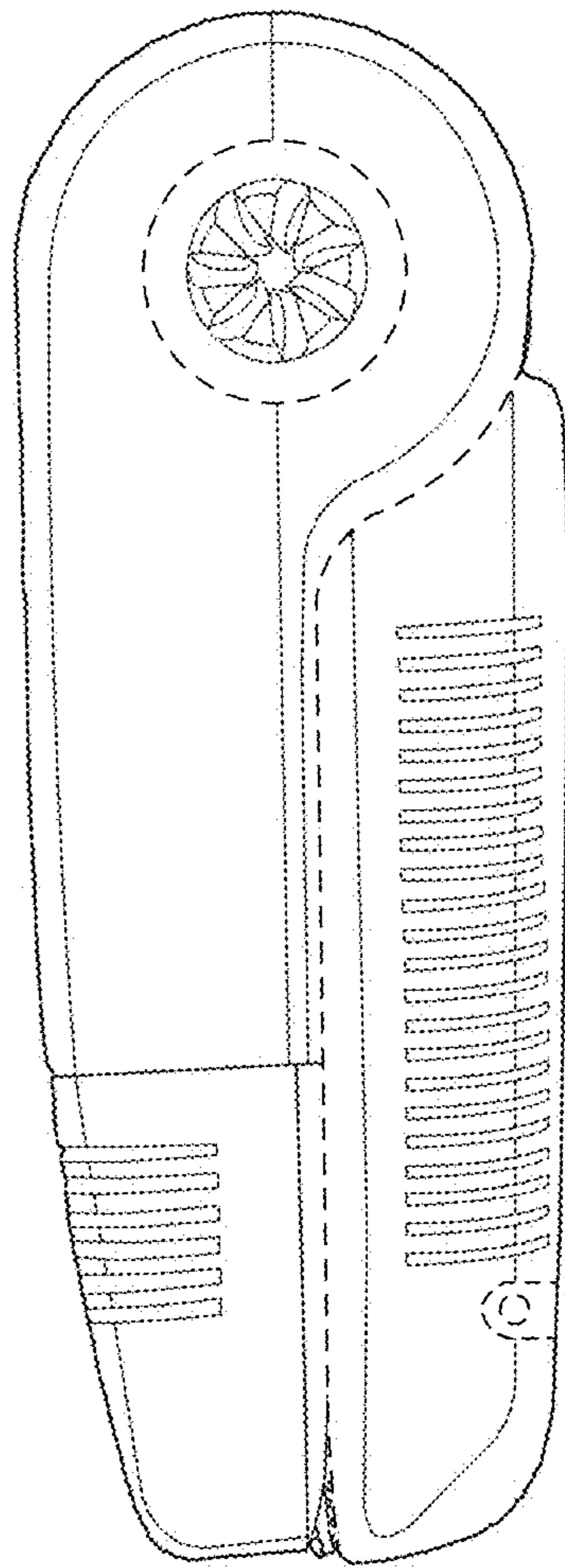

FIG. 4

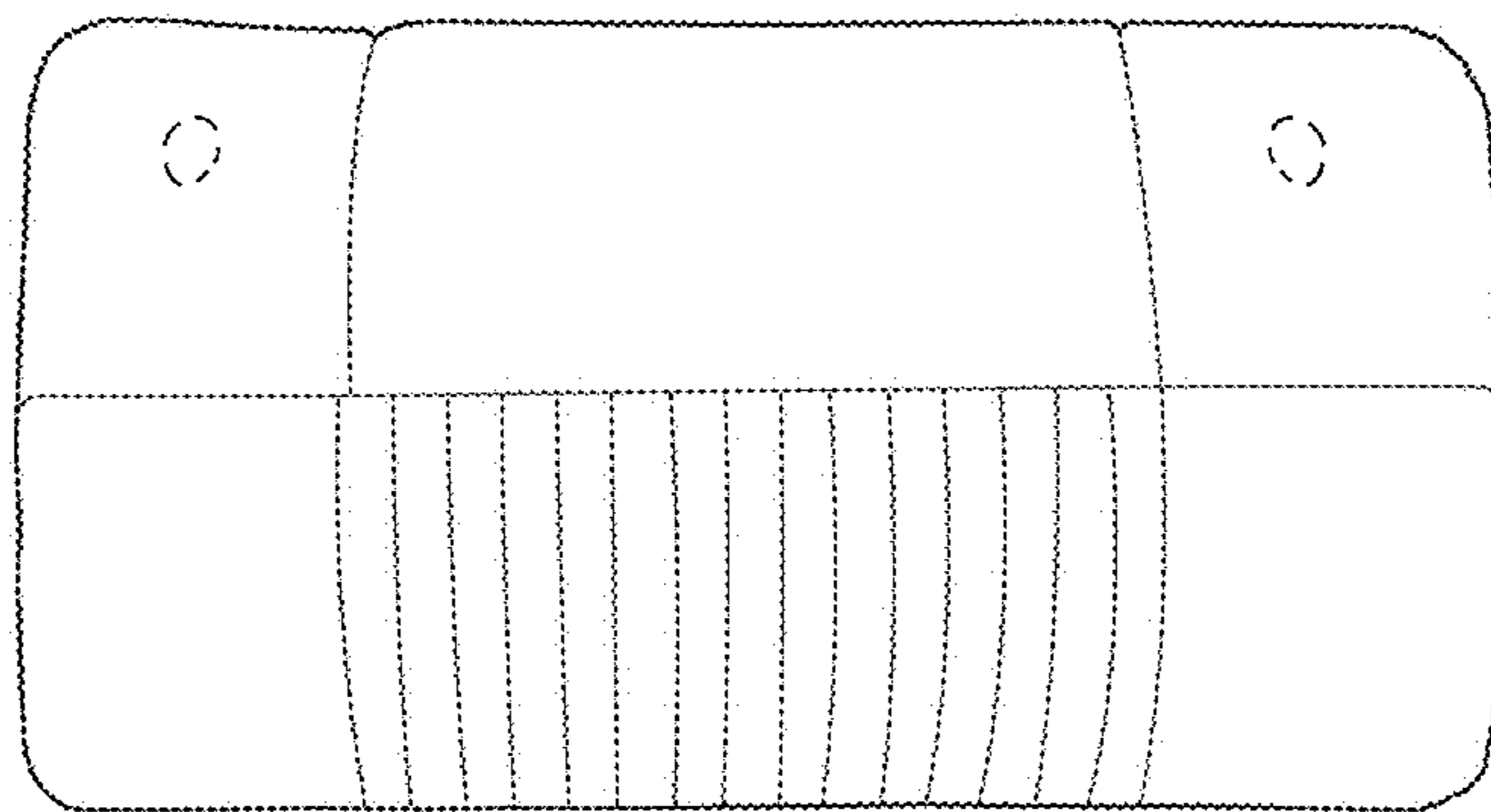

FIG. 5

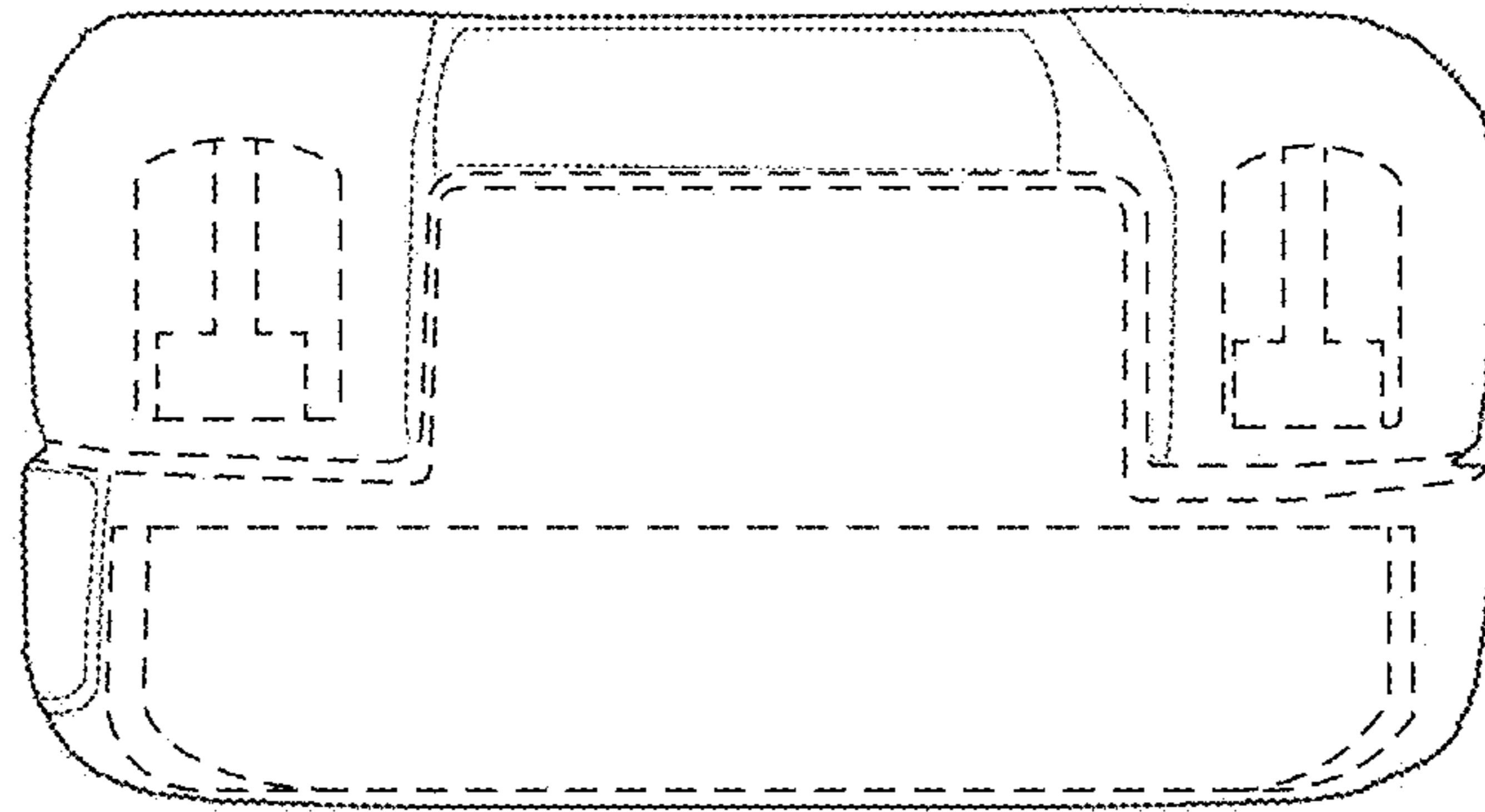

FIG. 6

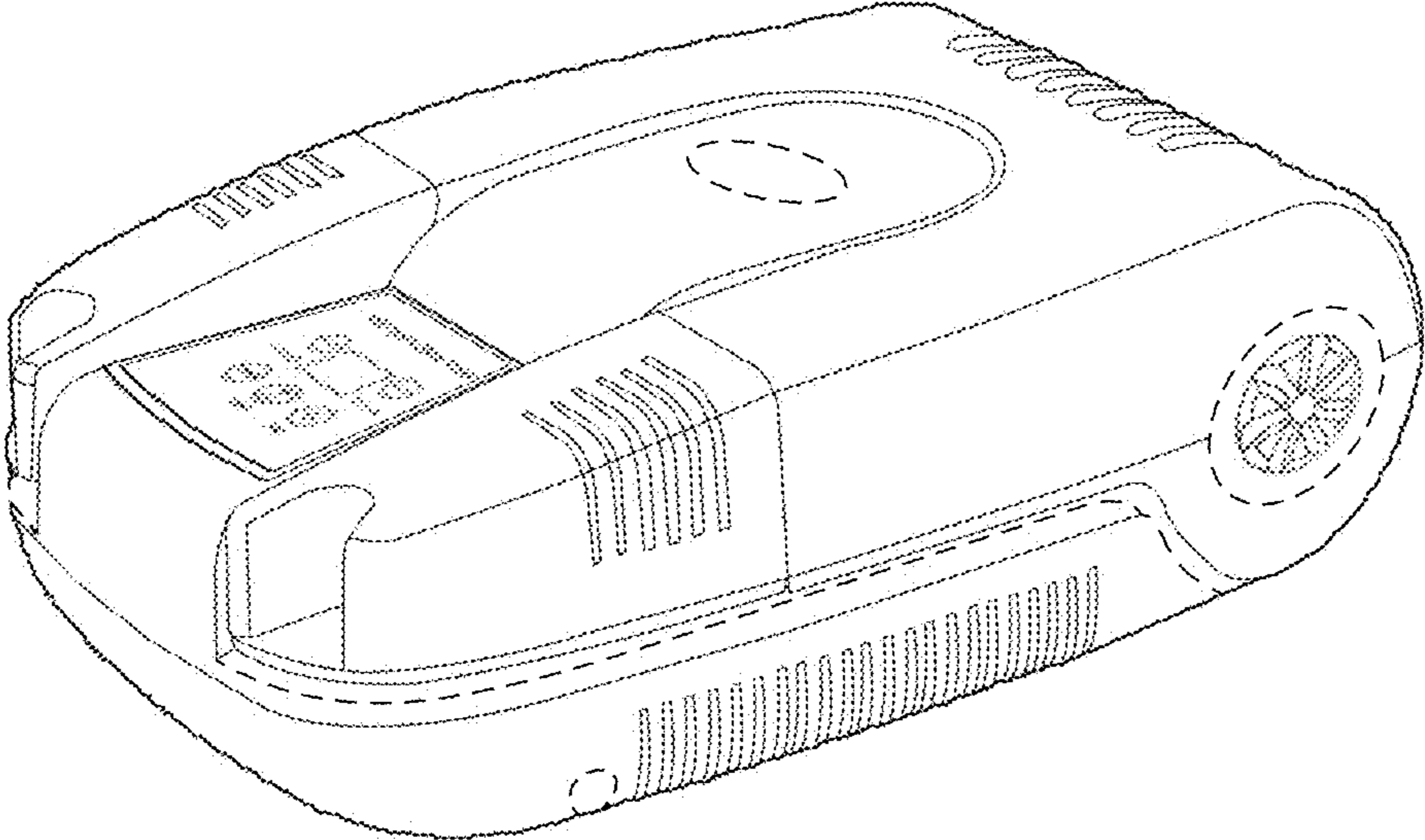

FIG. 7

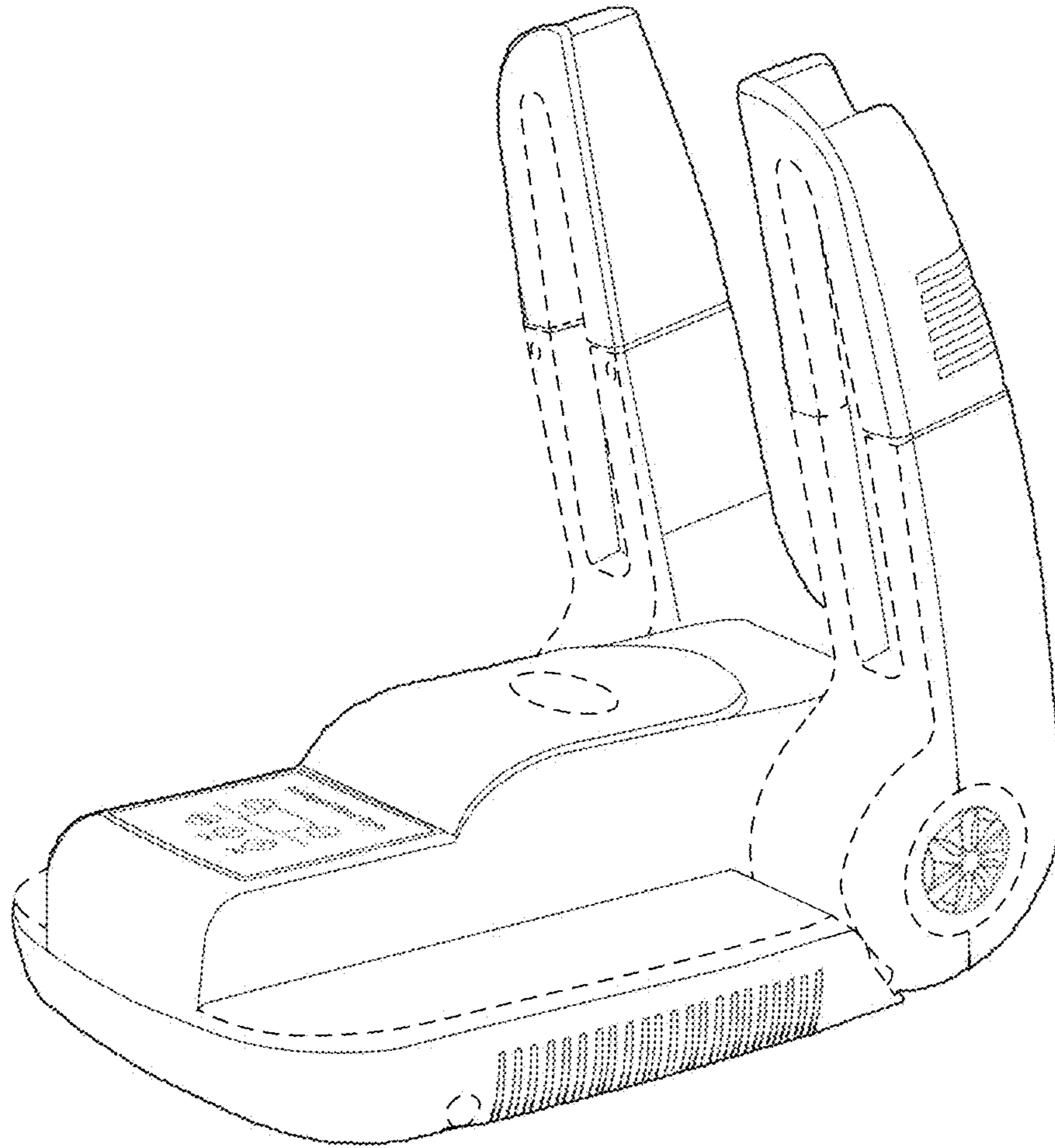

FIG. 8

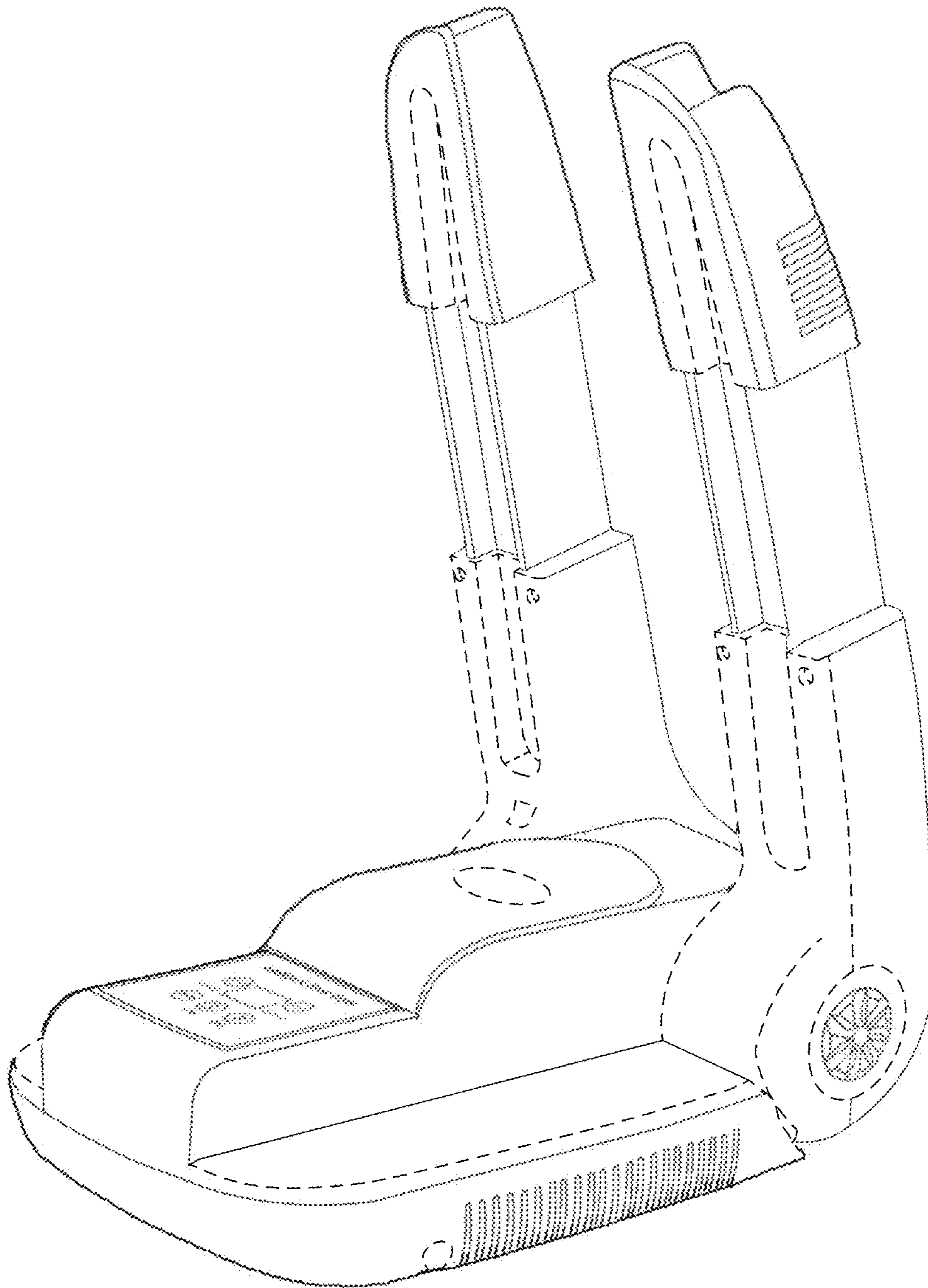

FIG. 9