



US00D872358S

(12) **United States Design Patent**  
**Liao**

(10) **Patent No.:** **US D872,358 S**

(45) **Date of Patent:** **\*\* Jan. 7, 2020**

(54) **HAIR DRYER**

(71) Applicant: **Dongguan Shengming Industrial Co., Ltd**, Dongguan, Guangdong (CN)

(72) Inventor: **Shengwang Liao**, Jiangxi (CN)

(\*\*) Term: **15 Years**

(21) Appl. No.: **29/697,722**

(22) Filed: **Jul. 10, 2019**

(51) **LOC (12) Cl.** ..... **28-03**

(52) **U.S. Cl.**  
USPC ..... **D28/13**

(58) **Field of Classification Search**  
USPC ..... D28/12-19  
CPC ..... A45D 20/00; A45D 20/48; A45D 20/50;  
A45D 20/52; A45D 20/525  
See application file for complete search history.

(56) **References Cited**

**U.S. PATENT DOCUMENTS**

D372,336 S 7/1996 Kip  
D388,538 S 12/1997 Kip  
6,889,445 B1 \* 5/2005 Varona ..... A45D 20/12  
34/97

D758,010 S \* 5/2016 Bates ..... D28/13  
D758,011 S \* 5/2016 Gammack ..... D28/13  
D791,407 S \* 7/2017 Smith ..... D28/13  
10,226,112 B2 \* 3/2019 Kerr ..... A45D 20/10  
2013/0269201 A1 \* 10/2013 Courtney ..... A45D 20/04  
34/97

\* cited by examiner

*Primary Examiner* — Zenia I Bennett

(74) *Attorney, Agent, or Firm* — ZANIP

(57) **CLAIM**

The ornamental design for a hair dryer, as shown and described.

**DESCRIPTION**

FIG. 1 is a front and top perspective view of a hair dryer, showing my design;  
FIG. 2 is a back and bottom perspective view thereof;  
FIG. 3 is a front view thereof;  
FIG. 4 is a back view thereof;  
FIG. 5 is a left side view thereof;  
FIG. 6 is a right side view thereof;  
FIG. 7 is top view thereof;  
FIG. 8 is a bottom view thereof; and,  
FIG. 9 is an enlarged view of the selected portion in FIG. 1. The broken lines shown in the drawings depict portions of the hair dryer in which the design is embodied that form no part of the claimed design.

**1 Claim, 9 Drawing Sheets**

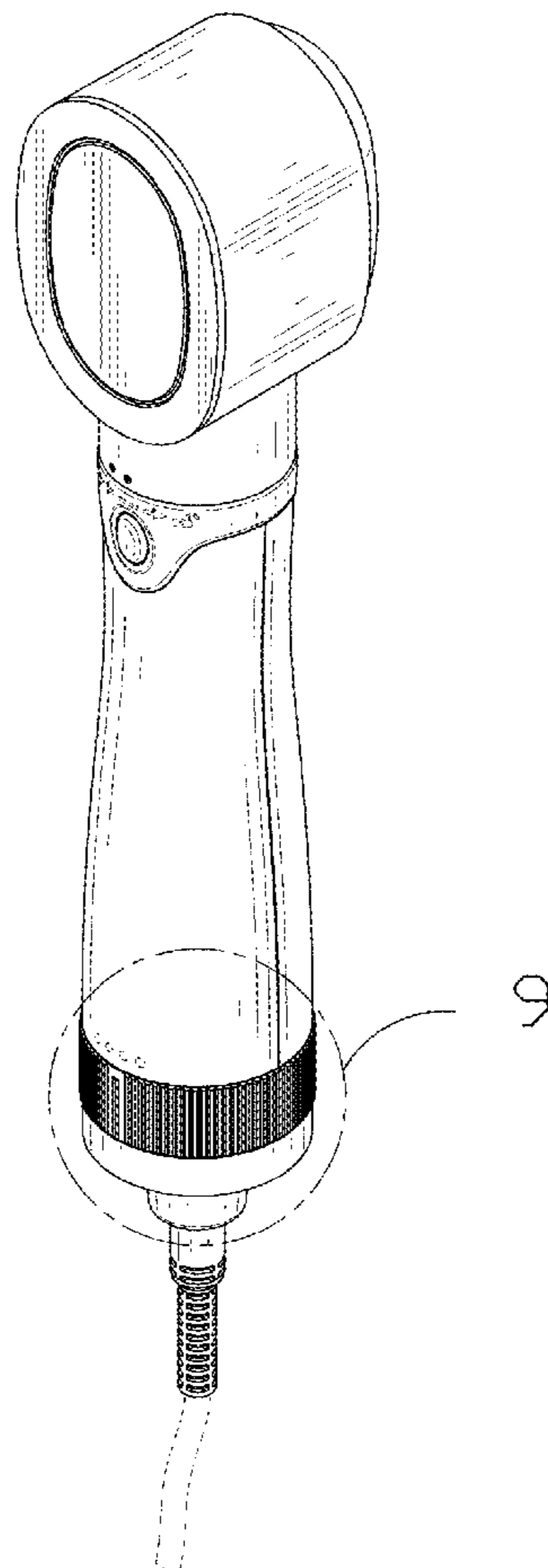

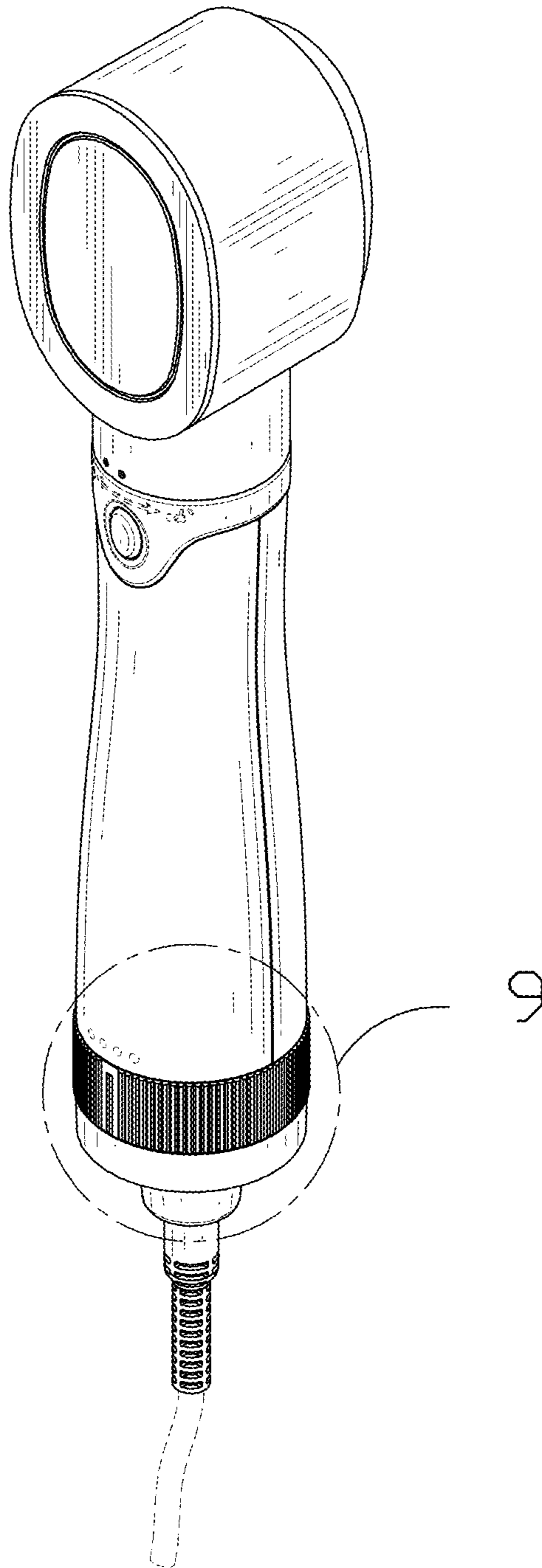

FIG. 1

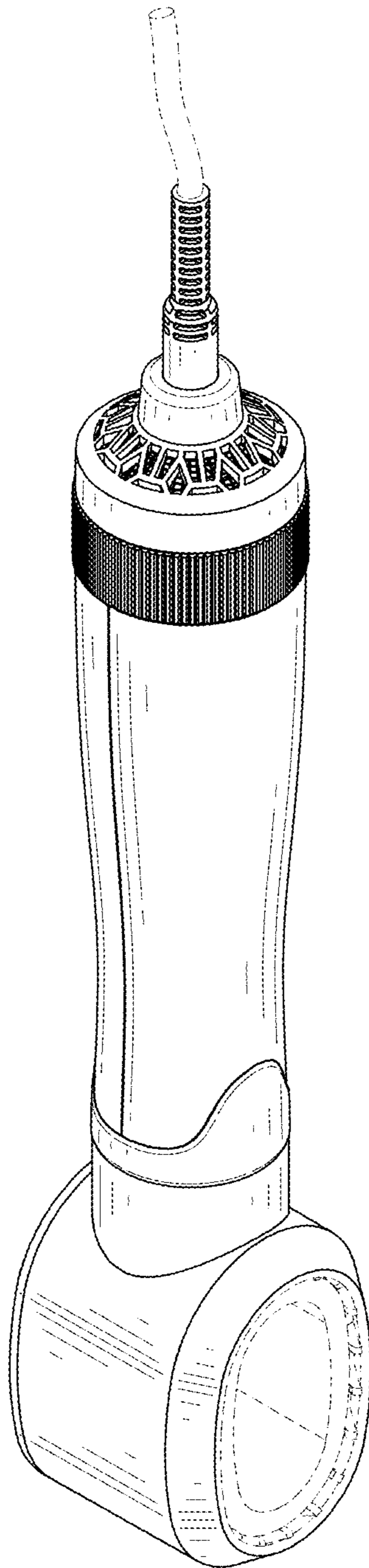

FIG. 2

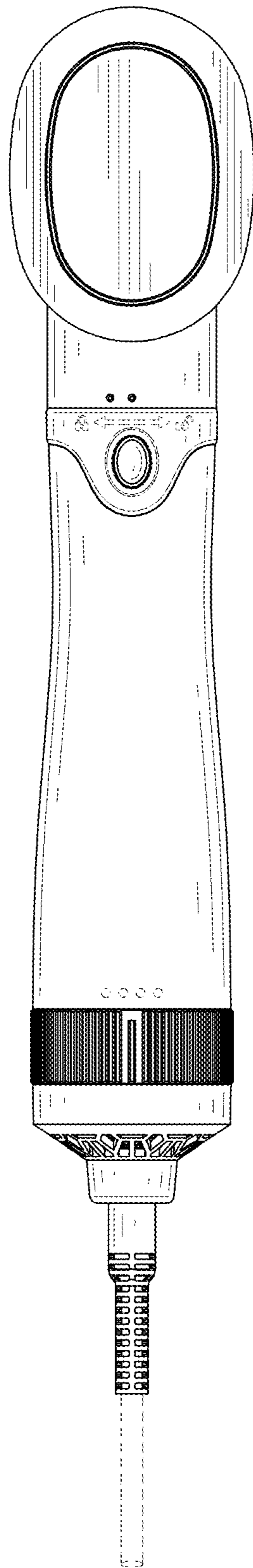

FIG. 3

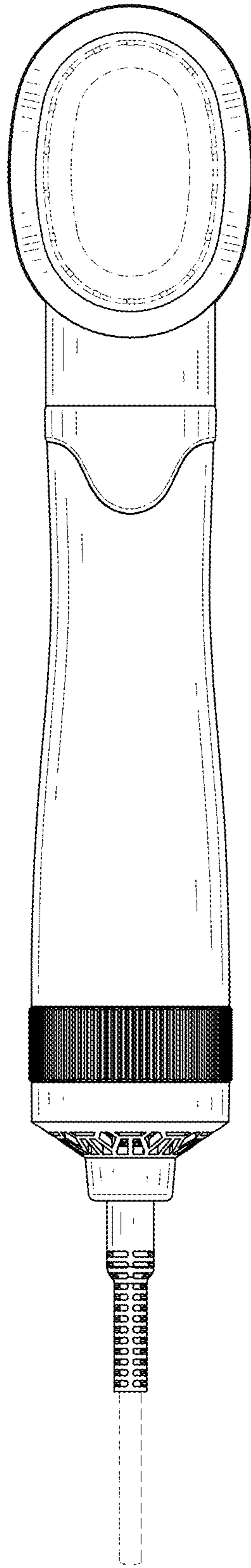

FIG. 4

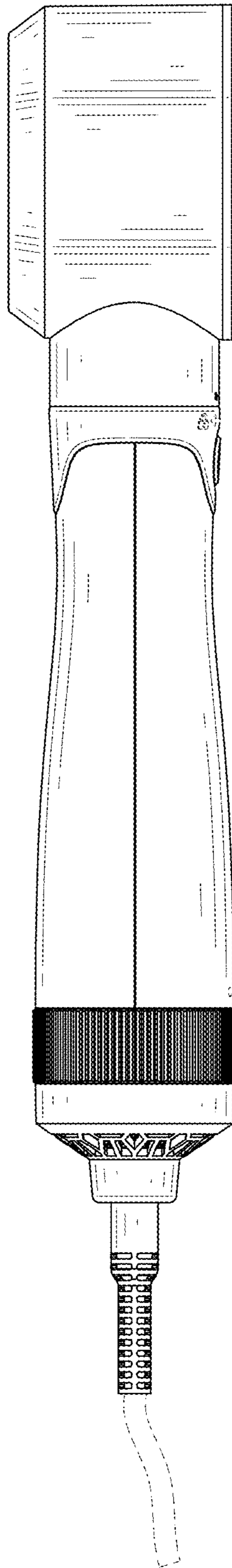

FIG. 5

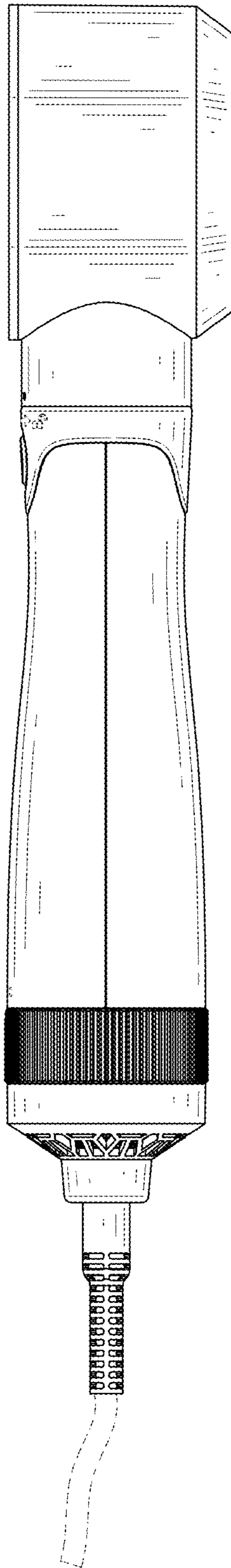

FIG. 6

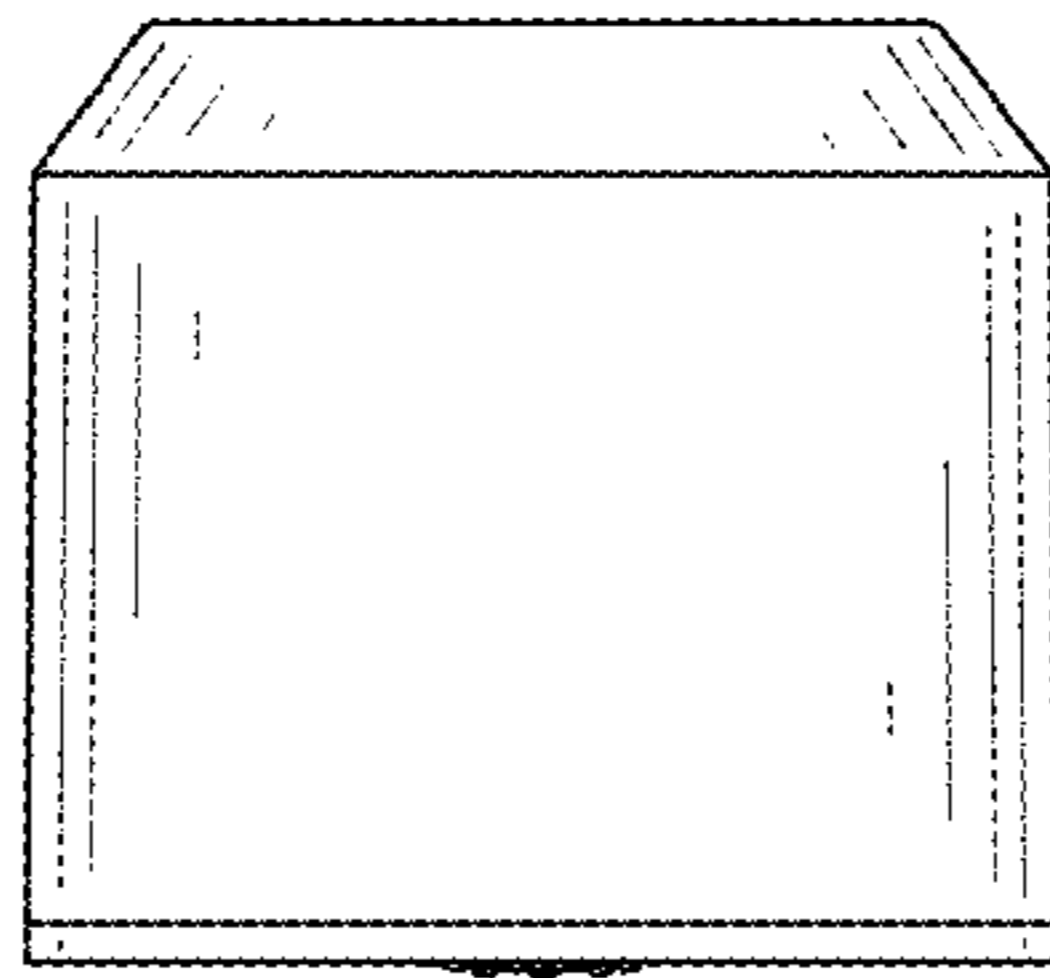

FIG. 7



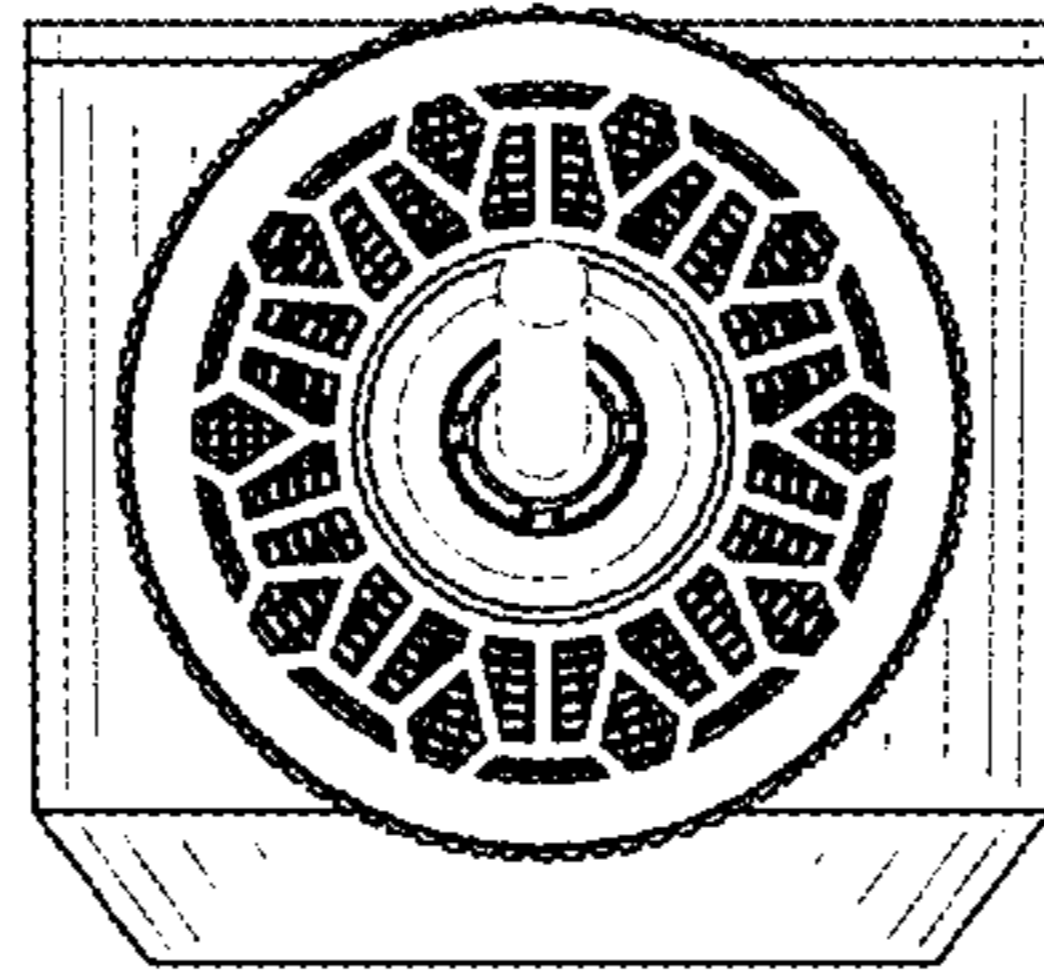

FIG. 8

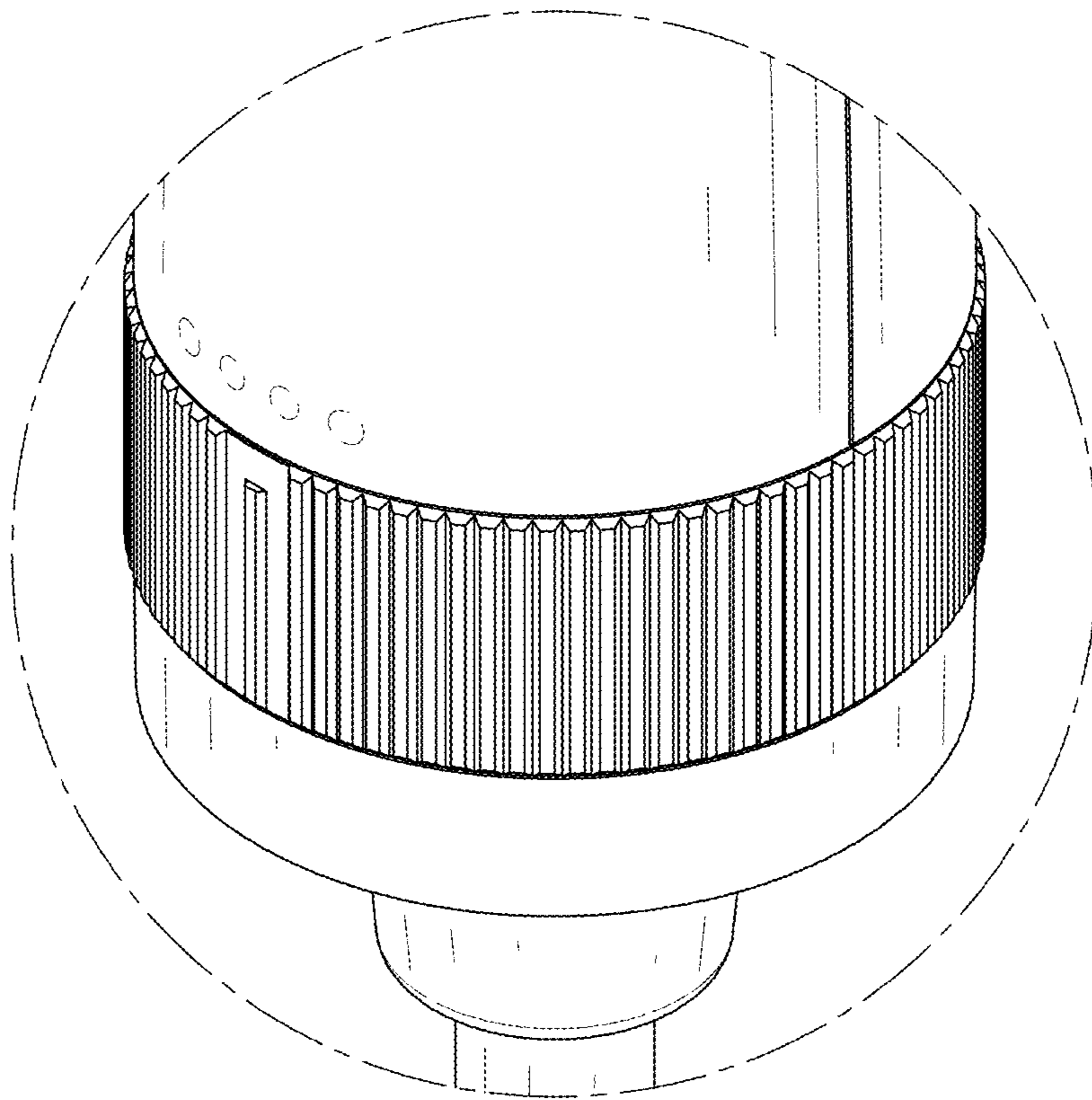

FIG. 9