



US00D872245S

(12) **United States Design Patent** (10) **Patent No.:** **US D872,245 S**  
**Mecker et al.** (45) **Date of Patent:** **\*\* Jan. 7, 2020**

(54) **DISPENSER**

FOREIGN PATENT DOCUMENTS

(71) Applicant: **S. C. JOHNSON & SON, INC.**,  
Racine, WI (US)

CA 125615 S 12/2008  
CA 130215 S 2/2010

(Continued)

(72) Inventors: **Alex Mecker**, Chicago, IL (US); **Peter Borowski**, Lake Bluff, IL (US); **Nick Rees**, New York, NY (US)

OTHER PUBLICATIONS

Notice of Preliminary Rejection, related Korean Application No. 30-2018-0040028, dated Feb. 21, 2019, 13 pages.

(Continued)

(73) Assignee: **S. C. Johnson & Son, Inc.**, Racine, WI (US)

*Primary Examiner* — Sheryl Lane

*Assistant Examiner* — Calvin E Vasant

(\*\*) Term: **15 Years**

(74) *Attorney, Agent, or Firm* — Quarles & Brady LLP

(21) Appl. No.: **29/638,731**

(57) **CLAIM**

The ornamental design for a dispenser, as shown and described.

(22) Filed: **Feb. 28, 2018**

(51) **LOC (12) Cl.** ..... **23-04**

(52) **U.S. Cl.**  
USPC ..... **D23/366**

**DESCRIPTION**

(58) **Field of Classification Search**

USPC .... D23/208, 355–369; D14/209.1, 212–213,  
D14/409; D11/144, 152, 153; D7/509,  
D7/523

CPC ..... A61L 9/02; A61L 9/03; A61L 9/12; A61L  
9/035; A61L 9/125

See application file for complete search history.

FIG. 1 is an isometric view of a top, front, and right side of an ornamental design for a dispenser;

FIG. 2 is a front elevational view of the dispenser of FIG. 1;

FIG. 3 is a rear elevational view of the dispenser of FIG. 1;

FIG. 4 is a right side elevational view of the dispenser of FIG. 1;

FIG. 5 is a left side elevational view of the dispenser of FIG. 1;

FIG. 6 is a top plan view of the dispenser of FIG. 1; and, FIG. 7 is a bottom plan view of the dispenser of FIG. 1.

The broken lines are included for the purpose of illustrating portions that form no part of the claimed design. The claimed portion extends between the lowermost solid line and the upper shade lines adjacent the dash-dash-dash lines, and between the shade lines adjacent the dash-dash-dash lines on a right side of the dispenser and the shade lines adjacent the dash-dash-dash lines on a left side of the dispenser.

(56) **References Cited**

U.S. PATENT DOCUMENTS

3,910,495 A 10/1975 Cummings et al.  
D285,123 S \* 8/1986 Schwartz ..... D26/118  
4,621,768 A 11/1986 Lhoste et al.  
4,731,520 A 3/1988 Glucksman et al.  
5,562,422 A 10/1996 Ganzon et al.  
5,616,973 A 4/1997 Khazanov et al.  
5,684,346 A 11/1997 Mickos et al.  
5,765,950 A 6/1998 Eno et al.  
5,792,717 A 8/1998 Takayama

(Continued)

**1 Claim, 6 Drawing Sheets**

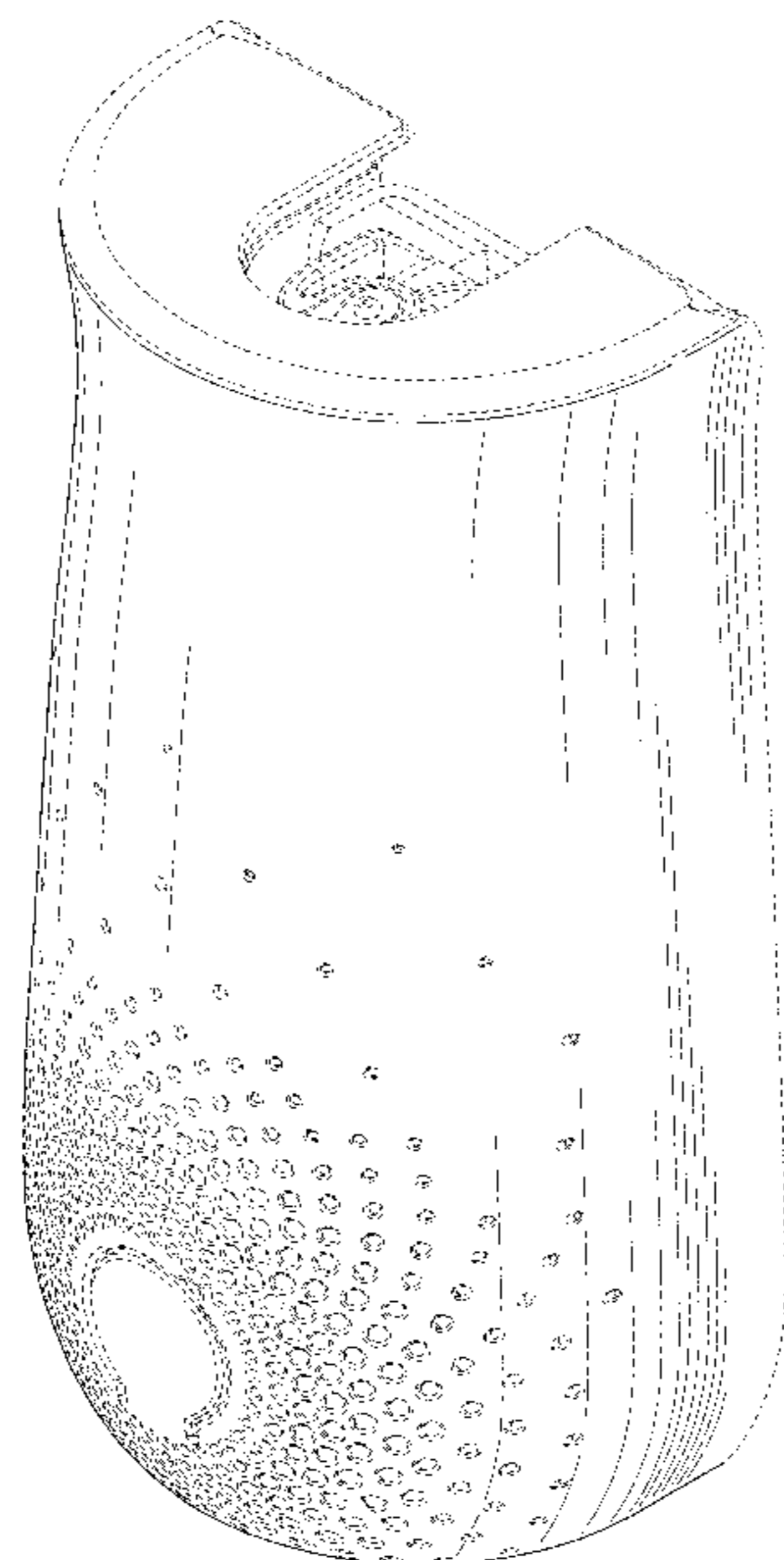

(56)

## References Cited

## U.S. PATENT DOCUMENTS

5,944,489	A	8/1999	Vaughn et al.	D580,265	S	11/2008	Turchi
6,036,108	A	3/2000	Chen	D580,274	S	11/2008	Abel
6,073,934	A	6/2000	Fondelius	D580,776	S	11/2008	Claughton et al.
6,104,867	A	8/2000	Stathakis et al.	7,455,245	B2	11/2008	Sipinski et al.
D430,658	S	9/2000	Farce	D582,278	S	12/2008	Bourne
D432,222	S	10/2000	Rymer et al.	D582,537	S	12/2008	Kay et al.
D437,744	S	2/2001	Young et al.	D583,038	S	12/2008	Kay et al.
6,203,282	B1	3/2001	Morin	D583,457	S	12/2008	Kay et al.
6,224,354	B1	5/2001	Brandt et al.	D584,809	S	1/2009	Porchia et al.
6,236,807	B1	5/2001	Ruffolo et al.	7,484,675	B2	2/2009	Brown
6,278,840	B1	8/2001	Basaganas Millan	D587,576	S	3/2009	Miller et al.
6,305,692	B1	10/2001	Arbeus	D596,939	S	7/2009	Moretti
6,305,906	B1	10/2001	Ekstrom	D597,192	S	7/2009	Drucker et al.
D451,021	S	11/2001	Berge et al.	D599,665	S	9/2009	Campbell
6,345,928	B2	2/2002	Bratthall et al.	7,600,697	B2	10/2009	Bankers et al.
6,386,487	B1	5/2002	Owesson et al.	D603,708	S	11/2009	Handy
6,435,836	B1	8/2002	Kobayashi et al.	D605,746	S	12/2009	Butler et al.
6,446,975	B1	9/2002	Bratthall	D605,747	S	12/2009	Butler et al.
6,446,976	B1	9/2002	Key et al.	7,628,338	B2	12/2009	Belongia et al.
D464,416	S	10/2002	von Dohlen et al.	7,631,814	B2	12/2009	Zarembinski
6,466,739	B2	10/2002	Ambrosi et al.	D607,315	S	1/2010	George et al.
6,520,745	B1	2/2003	Yamamoto et al.	D608,198	S	1/2010	Lohrman et al.
6,603,924	B2	8/2003	Brown et al.	D608,640	S	1/2010	Carreno
6,607,196	B2	8/2003	Carlsson	D610,249	S	2/2010	Robinson
6,632,075	B2	10/2003	Hallgren	D611,348	S	3/2010	Handy
D491,256	S	6/2004	Fellows et al.	D613,844	S	4/2010	Jorgensen
D492,597	S	7/2004	Norris et al.	7,746,063	B2	6/2010	Sabini et al.
D497,808	S	11/2004	Morris et al.	7,780,094	B2	8/2010	Caserta et al.
D501,546	S	2/2005	Cruver, IV et al.	D623,284	S	9/2010	Myojin et al.
D501,921	S	2/2005	Caserta et al.	D624,170	S	9/2010	Myojin et al.
6,889,003	B2	5/2005	Triplett et al.	D624,352	S	9/2010	Lion et al.
6,899,532	B2	5/2005	Eddy et al.	D624,783	S	10/2010	Lion et al.
D507,487	S	7/2005	Marroncles	D625,603	S	10/2010	Butler et al.
D507,636	S	7/2005	Baraky et al.	D632,377	S	2/2011	Blachford et al.
D511,967	S	11/2005	Bodet	D632,771	S	2/2011	Abbondanzio et al.
D512,136	S	11/2005	Wefler	D632,772	S	2/2011	Abbondanzio et al.
D512,938	S	12/2005	Morris et al.	D633,190	S	2/2011	Abbondanzio et al.
6,981,399	B1	1/2006	Nybo et al.	D633,229	S	2/2011	McWillis
D515,921	S	2/2006	Marroncles	D634,416	S	3/2011	Abbondanzio et al.
6,994,270	B2	2/2006	Wongosari et al.	D634,832	S	3/2011	Abbondanzio et al.
7,014,818	B2	3/2006	Rymer	D636,476	S	4/2011	Abbondanzio et al.
D523,129	S	6/2006	Caserta et al.	D636,860	S	4/2011	Abbondanzio et al.
D532,302	S	11/2006	Moretti	D637,274	S	5/2011	Chan et al.
7,140,553	B2	11/2006	Zobebe	D639,923	S	6/2011	Belongia et al.
D536,969	S	2/2007	Geier	D641,252	S	7/2011	Butler et al.
D538,915	S	3/2007	Anderson et al.	D643,102	S	8/2011	Abbondanzio et al.
7,195,462	B2	3/2007	Nybo et al.	D644,313	S	8/2011	Westphal
D539,892	S	4/2007	Caserta et al.	7,991,586	B2	8/2011	Silovic et al.
D543,326	S	5/2007	Dretzka	D644,926	S	9/2011	Davis et al.
7,222,760	B1	5/2007	Tsay	D645,947	S	9/2011	Sevy
D544,085	S	6/2007	Schriner et al.	D646,768	S	10/2011	Chan et al.
D544,087	S	6/2007	Baraky et al.	D647,187	S	10/2011	Chan et al.
D544,592	S	6/2007	Caserta et al.	8,029,317	B2	10/2011	Albers et al.
D544,593	S	6/2007	Yamamoto	D654,761	S	2/2012	Herbst
D545,626	S	7/2007	Frank	8,141,793	B2	3/2012	Wallis et al.
7,244,398	B2	7/2007	Kotary et al.	D657,448	S	4/2012	Herfort
D548,317	S	8/2007	Newton et al.	D657,860	S	4/2012	Sordo et al.
D548,318	S	8/2007	Copeman	D658,072	S	4/2012	Davis et al.
D548,587	S	8/2007	DuVal et al.	D658,315	S	4/2012	Walters
D549,596	S	8/2007	Ioannides et al.	D658,915	S	5/2012	Fernandes et al.
D551,076	S	9/2007	Bloc	D659,267	S	5/2012	Slatkin et al.
7,278,589	B2	10/2007	Wongosari et al.	D659,536	S	5/2012	Bedford et al.
7,311,883	B2	12/2007	Basaganas Millan	D659,817	S	5/2012	Mandell et al.
D559,434	S	1/2008	Morris et al.	D659,818	S	5/2012	Belongia et al.
D560,018	S	1/2008	Morris et al.	D660,996	S	5/2012	Rein
D561,021	S	2/2008	DuVal et al.	D662,237	S	6/2012	Baraky et al.
D564,876	S	3/2008	Nickel et al.	8,197,192	B2	6/2012	Andersson
D568,978	S	5/2008	Kennedy et al.	D663,018	S	7/2012	Sordo et al.
D569,247	S	5/2008	Decottignies	8,226,385	B2	7/2012	Wendel et al.
D574,072	S	7/2008	Carlson et al.	8,231,337	B2	7/2012	Andersson
D574,199	S	8/2008	Griffith et al.	8,251,299	B1	8/2012	Irvin
D575,153	S	8/2008	Caroen et al.	D666,491	S	9/2012	Adams et al.
D576,874	S	9/2008	Miller et al.	D666,706	S	9/2012	Sevy
7,420,134	B1	9/2008	Leary et al.	D667,574	S	9/2012	Abbondanzio et al.
D580,039	S	* 11/2008	Zlotnik ..... D23/366	8,297,119	B2	10/2012	Parkinson
				D672,481	S	12/2012	Arslanian
				D672,858	S	12/2012	Abbondanzio et al.
				D672,861	S	12/2012	Adair et al.
				D675,308	S	1/2013	Freeborn et al.



(56)

References Cited

U.S. PATENT DOCUMENTS

D675,309 S 1/2013 Freeborn et al.  
 8,353,676 B2 1/2013 Kallesoe  
 8,376,698 B2 2/2013 Vedsted  
 D679,793 S 4/2013 Feiz et al.  
 D680,377 S 4/2013 Romley  
 D680,432 S 4/2013 Geier  
 D680,637 S 4/2013 Blachford et al.  
 D681,182 S 4/2013 Tomas Vilarasa et al.  
 D681,183 S 4/2013 Blachford et al.  
 D682,448 S 5/2013 Nugent  
 D686,718 S 7/2013 Gordon et al.  
 8,485,454 B1 7/2013 Irvin et al.  
 8,485,530 B2 7/2013 Johansson et al.  
 8,491,277 B2 7/2013 Kawabata et al.  
 8,519,581 B2 8/2013 Bradfield  
 D689,364 S 9/2013 Sanders  
 D689,664 S 9/2013 Dietvorst et al.  
 D689,998 S 9/2013 Carbone et al.  
 8,523,187 B2 9/2013 Eriksson  
 D691,255 S 10/2013 Abbondanzio et al.  
 8,608,428 B2 12/2013 Andersson  
 8,610,309 B2 12/2013 Kragelund  
 8,624,452 B2 1/2014 Kubes  
 8,633,623 B2 1/2014 Bingler  
 D699,075 S 2/2014 Mariotti  
 8,659,190 B2 2/2014 Chamberlin et al.  
 8,659,191 B2 2/2014 Chamberlin et al.  
 D701,120 S 3/2014 Sanders  
 8,692,425 B2 4/2014 Creviston et al.  
 D707,373 S 6/2014 Nugent  
 D707,805 S 6/2014 Brewer et al.  
 D709,761 S 7/2014 Sanders  
 D710,743 S 8/2014 Bartter  
 8,803,380 B2 8/2014 Chamberlin et al.  
 8,807,970 B2 8/2014 Schlenhoff et al.  
 8,816,196 B2 8/2014 Williams et al.  
 8,816,197 B2 8/2014 Campbell et al.  
 D712,739 S 9/2014 Lapsker  
 D713,517 S 9/2014 Dodge et al.  
 8,844,977 B2 9/2014 Sodergard  
 D716,432 S 10/2014 Viala et al.  
 8,859,899 B2 10/2014 Skrypka et al.  
 8,870,030 B2 10/2014 Demarest et al.  
 D717,123 S 11/2014 Epstein  
 D721,275 S 1/2015 Thijssen et al.  
 D721,278 S 1/2015 Eble  
 8,949,045 B2 2/2015 Skovmose Kallesoe  
 D724,192 S 3/2015 Mecker  
 D724,945 S 3/2015 Davis et al.  
 8,975,792 B2 3/2015 Chamberlin et al.  
 8,978,999 B2 3/2015 Lesniak et al.  
 8,985,398 B2 3/2015 Demarest et al.  
 D729,924 S 5/2015 Hsiao  
 9,041,260 B2 5/2015 Ramey  
 D733,382 S 6/2015 Bos et al.  
 9,048,710 B2 6/2015 Chamberlin et al.  
 D736,095 S 8/2015 Brochado et al.  
 9,099,900 B2 8/2015 Glubrecht  
 9,103,344 B2 8/2015 Andresen  
 9,121,270 B2 9/2015 Seitter  
 D740,163 S 10/2015 Pettigrew et al.  
 D741,987 S 10/2015 Gamble et al.  
 D742,561 S 11/2015 Kasha  
 9,239,056 B2 1/2016 Miyazaki et al.  
 9,259,499 B2 2/2016 Atkinson et al.  
 D750,491 S 3/2016 Campbell et al.  
 D750,492 S 3/2016 Campbell et al.  
 D752,378 S 3/2016 Wang  
 9,272,065 B2 3/2016 Santini et al.  
 9,331,543 B2 5/2016 Hamer et al.  
 9,370,594 B2 6/2016 Gasper et al.  
 D764,043 S 8/2016 Sanders et al.  
 D764,650 S 8/2016 Sanders et al.  
 D765,440 S 9/2016 Clough et al.  
 D766,084 S 9/2016 Jiang

D767,810 S 9/2016 Li  
 D768,834 S 10/2016 Schuller et al.  
 D770,852 S 11/2016 Vu et al.  
 D776,247 S 1/2017 King et al.  
 D776,800 S 1/2017 King et al.  
 D781,488 S 3/2017 Patton  
 D782,309 S 3/2017 Jiang  
 D787,948 S 5/2017 Scott et al.  
 D846,725 S \* 4/2019 Mecker ..... D23/366  
 D849,921 S \* 5/2019 Gobber ..... D23/366  
 D852,938 S \* 7/2019 Schumacher ..... D23/366  
 D853,548 S \* 7/2019 Schumacher ..... D23/366  
 2004/0067172 A1 4/2004 Ehrlich et al.  
 2004/0129795 A1 7/2004 Wongosari et al.  
 2006/0202050 A1 9/2006 Caserta et al.  
 2008/0087740 A1 4/2008 Gusenoff et al.  
 2008/0099483 A1 5/2008 Anderson et al.  
 2008/0156896 A1 7/2008 Anderson et al.  
 2008/0272201 A1 11/2008 Bankers et al.  
 2008/0283625 A1 11/2008 Bedford et al.  
 2009/0218415 A1 9/2009 Faires  
 2009/0302056 A1 12/2009 Butler  
 2010/0038379 A1 2/2010 Butler et al.  
 2010/0193599 A1 8/2010 Butler et al.  
 2010/0237108 A1 9/2010 Anderson et al.  
 2011/0168745 A1 7/2011 Bedford et al.  
 2012/0111446 A1 5/2012 Butler et al.  
 2012/0111966 A1 5/2012 Barlow et al.  
 2012/0181350 A1 7/2012 Snider  
 2013/0001315 A1 1/2013 Butler et al.  
 2014/0070016 A1 3/2014 Butler et al.  
 2014/0158788 A1 6/2014 Mikkelsen et al.  
 2014/0191061 A1 7/2014 Koontz et al.  
 2015/0108234 A1 4/2015 Butler et al.  
 2016/0151528 A1 6/2016 Duffield  
 2017/0065992 A1 3/2017 Clough et al.

FOREIGN PATENT DOCUMENTS

CA 145673 S 12/2012  
 CA 145749 S 12/2012  
 CA 145679 S 3/2013  
 CA 147945 S 11/2013  
 CA 152784 S 11/2013  
 CA 163080 S 2/2016  
 EM 000007471-0001 4/2003  
 EM 000076955-0012 9/2003  
 EM 000241195-0006 10/2004  
 EM 000418538-0002 10/2005  
 EM 000478201-0001 2/2006  
 EM 000487251-0003 2/2006  
 EM 000551643-0001 6/2006  
 EM 000551643-0002 6/2006  
 EM 000551643-0003 6/2006  
 EM 000551643-0004 6/2006  
 EM 000551643-0005 6/2006  
 EM 000551643-0006 6/2006  
 EM 000658828-0002 1/2007  
 EM 000688023-0009 3/2007  
 EM 000755061-0001 7/2007  
 EM 000873757-0001 2/2008  
 EM 000884655-0003 2/2008  
 EM 000983069-0003 8/2008  
 EM 000983069-0004 8/2008  
 EM 001171656-0003 10/2009  
 EM 001239875-0001 10/2010  
 EM 001239875-0002 10/2010  
 EM 001239875-0003 10/2010  
 EM 001239875-0004 10/2010  
 EM 001239875-0005 10/2010  
 EM 001239875-0006 10/2010  
 EM 001239875-0007 10/2010  
 EM 001239875-0008 10/2010  
 EM 001239990-0003 10/2010  
 EM 001239990-0007 10/2010  
 EM 001239990-0009 10/2010  
 EM 001239990-0012 10/2010  
 EM 001239990-0013 10/2010  
 EM 001251490-0001 12/2010

(56)

References Cited

FOREIGN PATENT DOCUMENTS

EM	001251490-0002	12/2010
EM	001251490-0003	12/2010
EM	001251490-0004	12/2010
EM	001797150-0001	12/2010
EM	001797150-0002	12/2010
EM	001271894-0001	4/2011
EM	001917774-0001	9/2011
EM	001948266-0001	11/2011
EM	001948324-0001	11/2011
EM	001948365-0001	11/2011
EM	001977398-0002	1/2012
EM	001977398-0003	1/2012
EM	001977398-0005	1/2012
EM	001977398-0006	1/2012
EM	002021089-0001	4/2012
EM	001335087-0003	7/2012
EM	001342927-0001	8/2012
EM	001342927-0002	8/2012
EM	001342927-0003	8/2012
EM	001342927-0004	8/2012
EM	001343164-0004	9/2012
EM	002162040-0001	1/2013
EM	001361356-0001	2/2013
EM	001361356-0002	2/2013
EM	001361356-0003	2/2013
EM	001361356-0004	2/2013
EM	002275842-0001	7/2013
EM	002275842-0002	7/2013
EM	002275842-0003	7/2013
EM	002275842-0004	7/2013
EM	001381149-0001	8/2013
EM	002292334-0001	8/2013
EM	002330696-0001	10/2013
EM	002330696-0002	10/2013
EM	002354530-0001	11/2013
EM	002354670-0001	11/2013

EM	001421366-0002	9/2014
EM	002604728-0001	12/2014
EM	002604728-0002	12/2014
EM	002690198-0001	4/2015
EM	002690198-0002	4/2015
EM	002690198-0003	4/2015
EM	002690198-0004	4/2015
EM	002690198-0005	4/2015
EM	002690198-0006	4/2015
EM	002690198-0007	4/2015
EM	002840553-0016	10/2015
EM	002971986-0001	2/2016
EM	003304104-0001	7/2016
EM	003422724-0001	10/2016
EM	003850601-0022	4/2017
EP	0736248 A1	10/1996
EP	1270022 B1	9/2004
EP	1302106 B1	2/2005
JP	1341589 S	10/2008
JP	1470820 S	6/2013
JP	1489715	2/2014
KR	3020160061664 *	11/2017
WO	DM/057247	7/2001
WO	2005/084721 A1	9/2005
WO	DM/075912	4/2011
WO	DM/079027	7/2012
WO	DM/079361	9/2012
WO	DM/082262	11/2013
WO	DM/086082	2/2015
WO	DM/091142	12/2015
WO	DM/089961	2/2016
WO	DM/094518	11/2016

OTHER PUBLICATIONS

Notice of Allowance issued in corresponding Japanese Application No. 2018-018709, dated Nov. 5, 2019, 3 pages.

\* cited by examiner



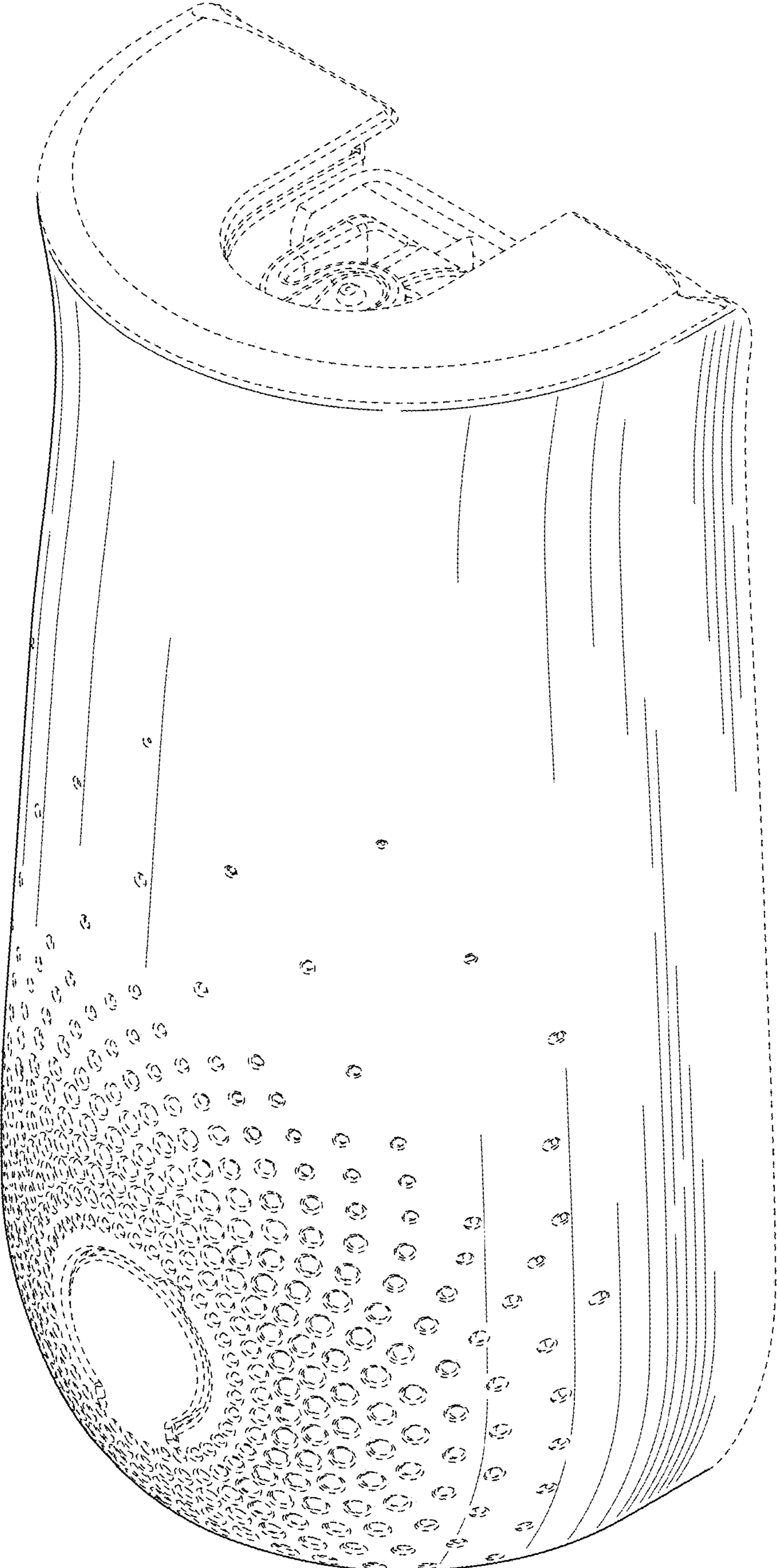

FIG. 1

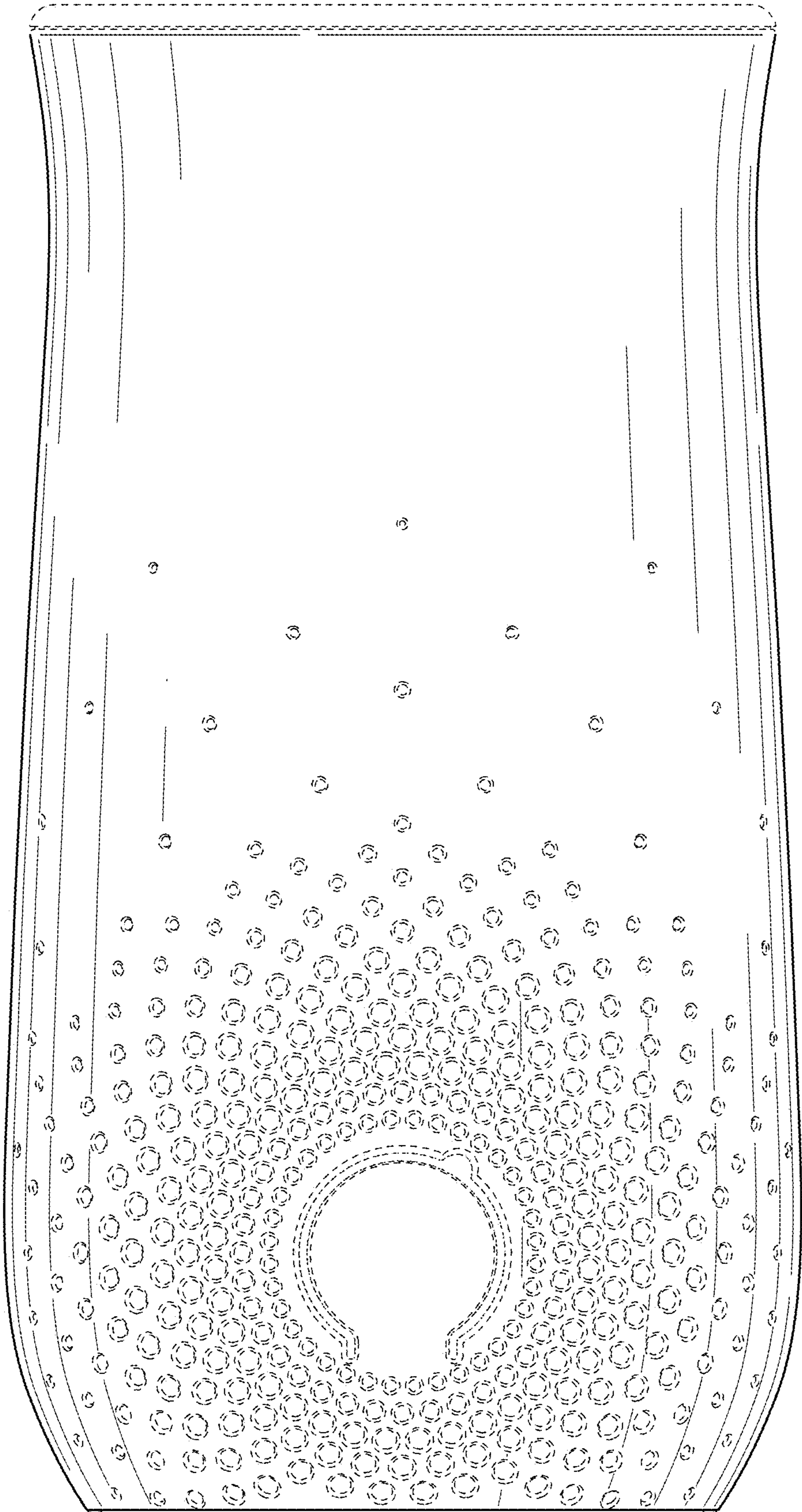

FIG. 2

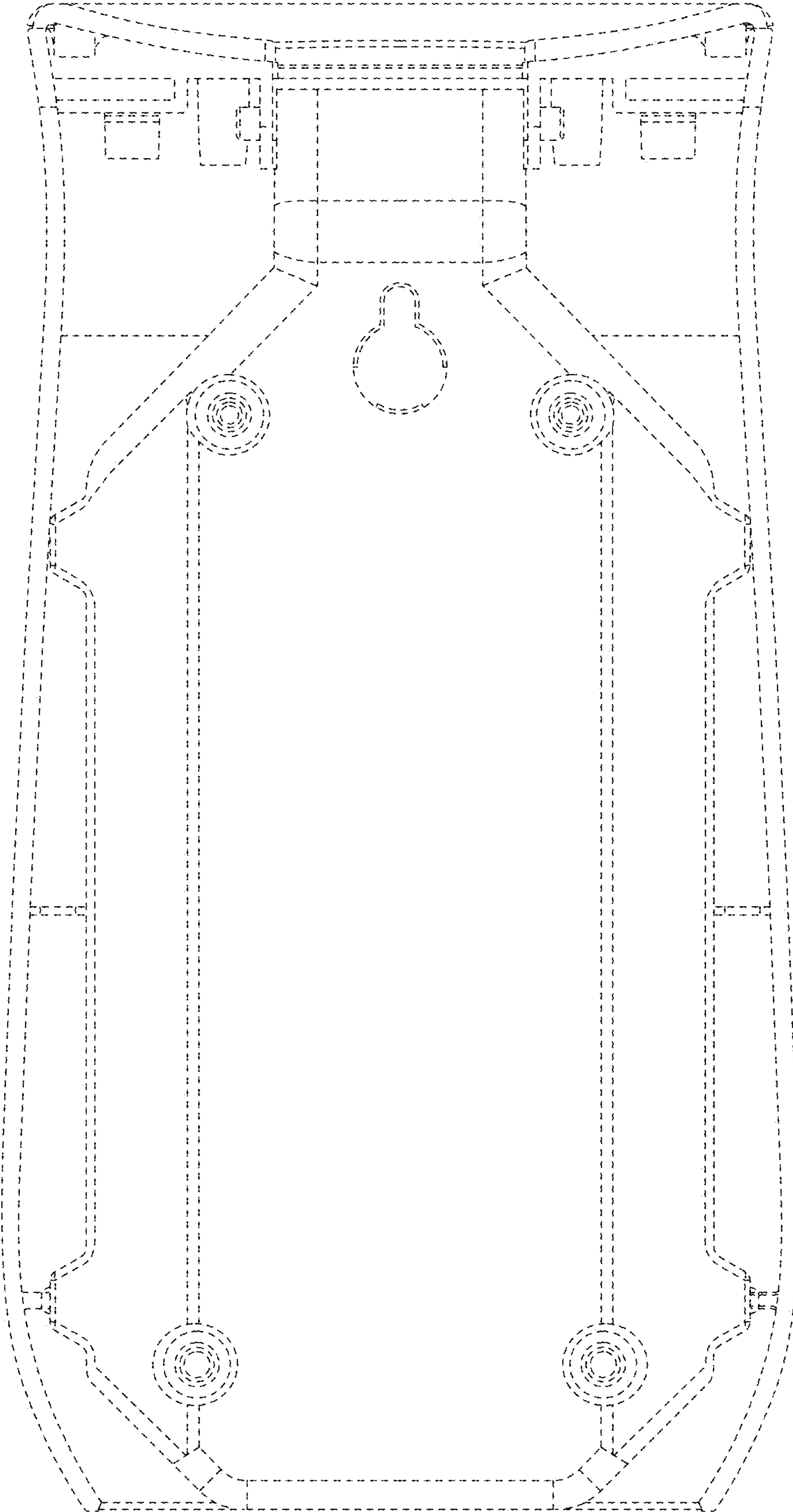

FIG. 3

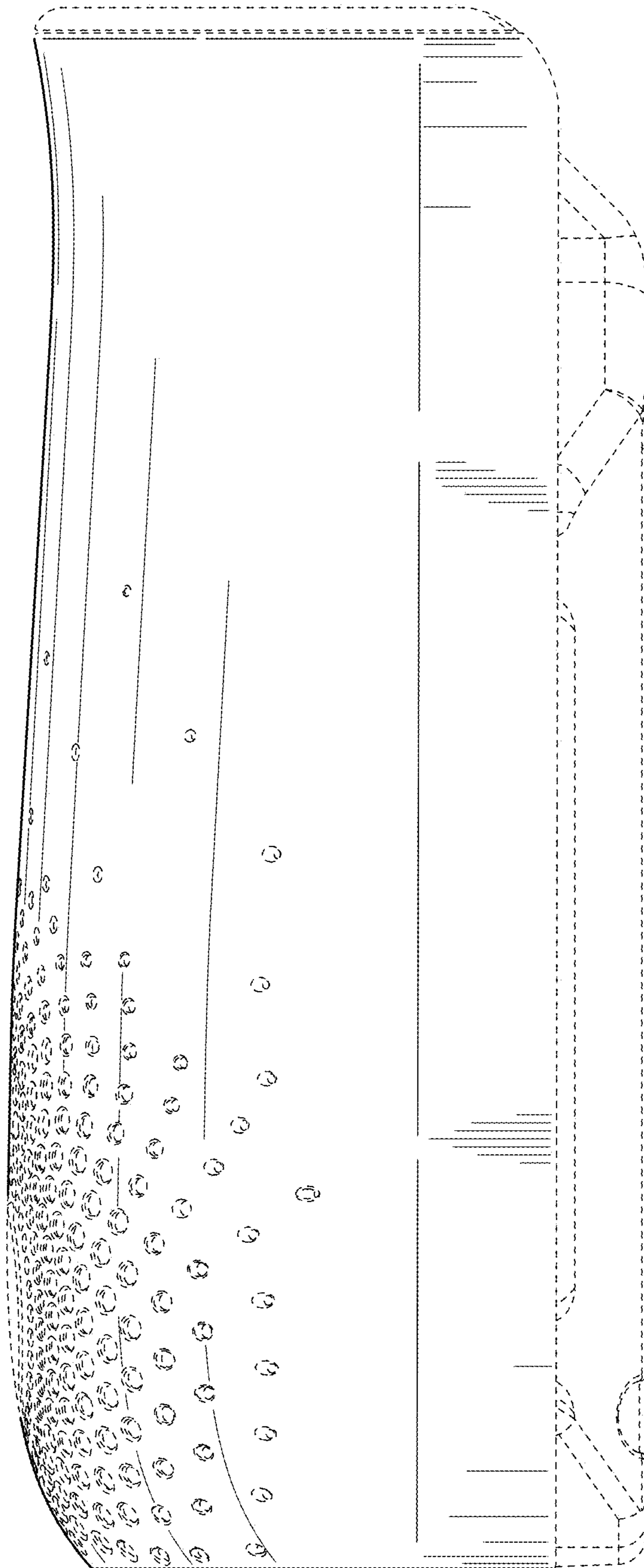

FIG. 4



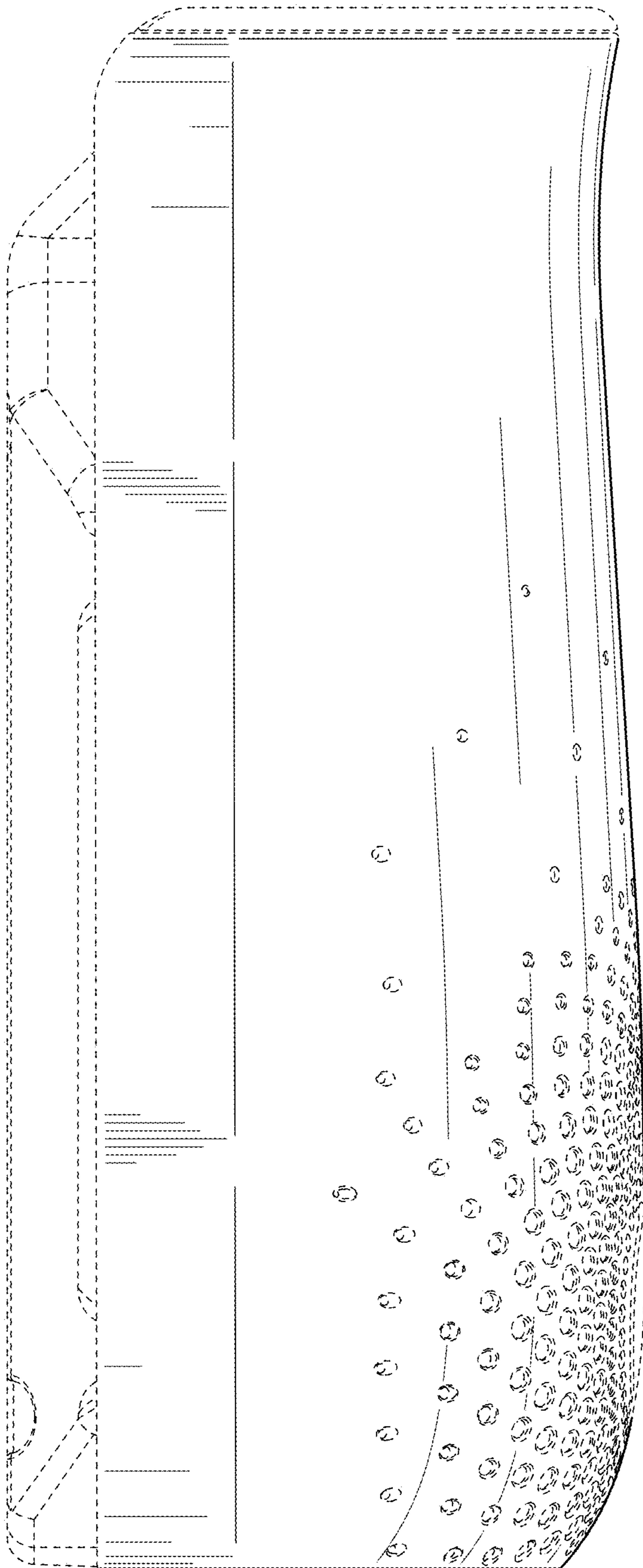

FIG. 5

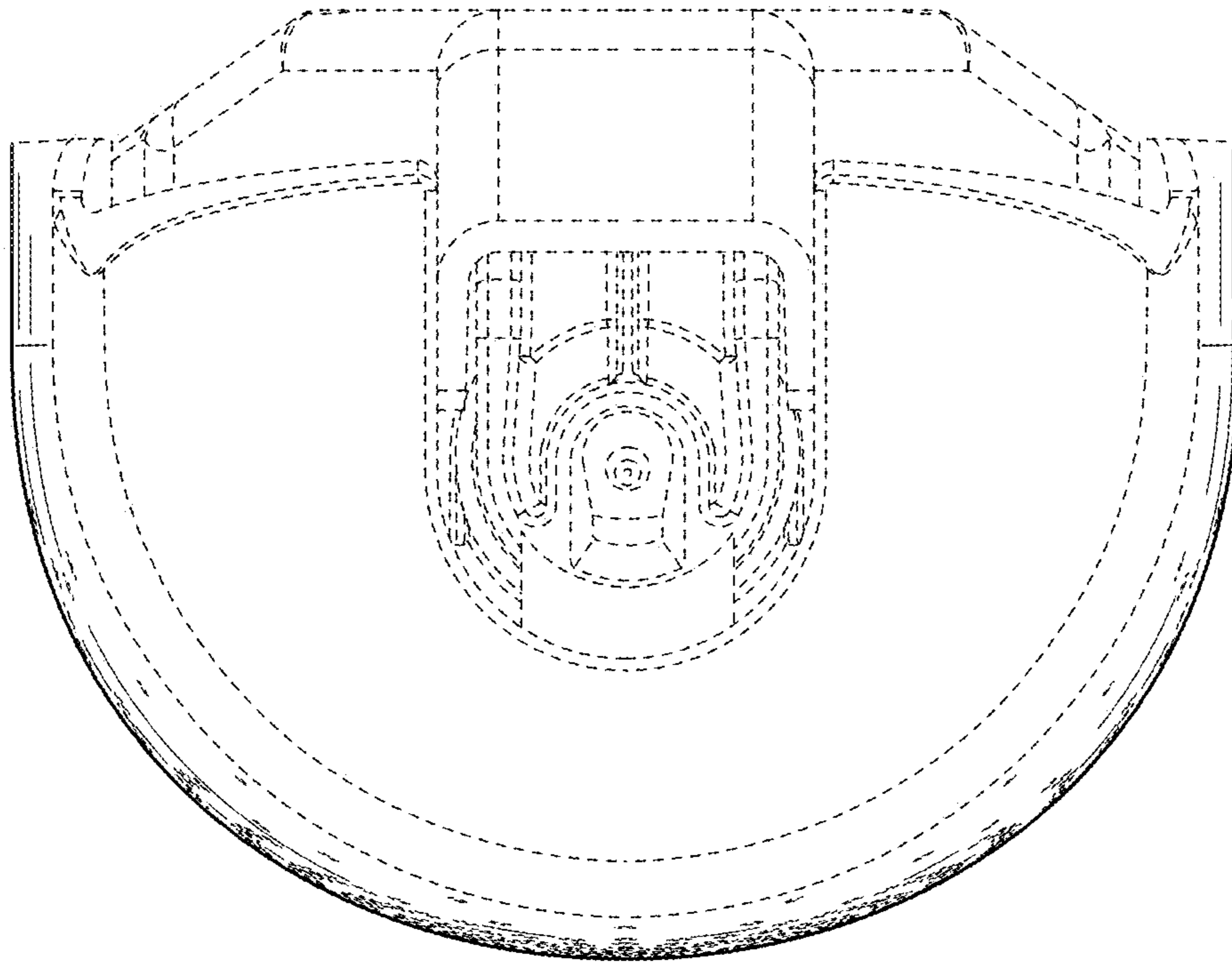

FIG. 6

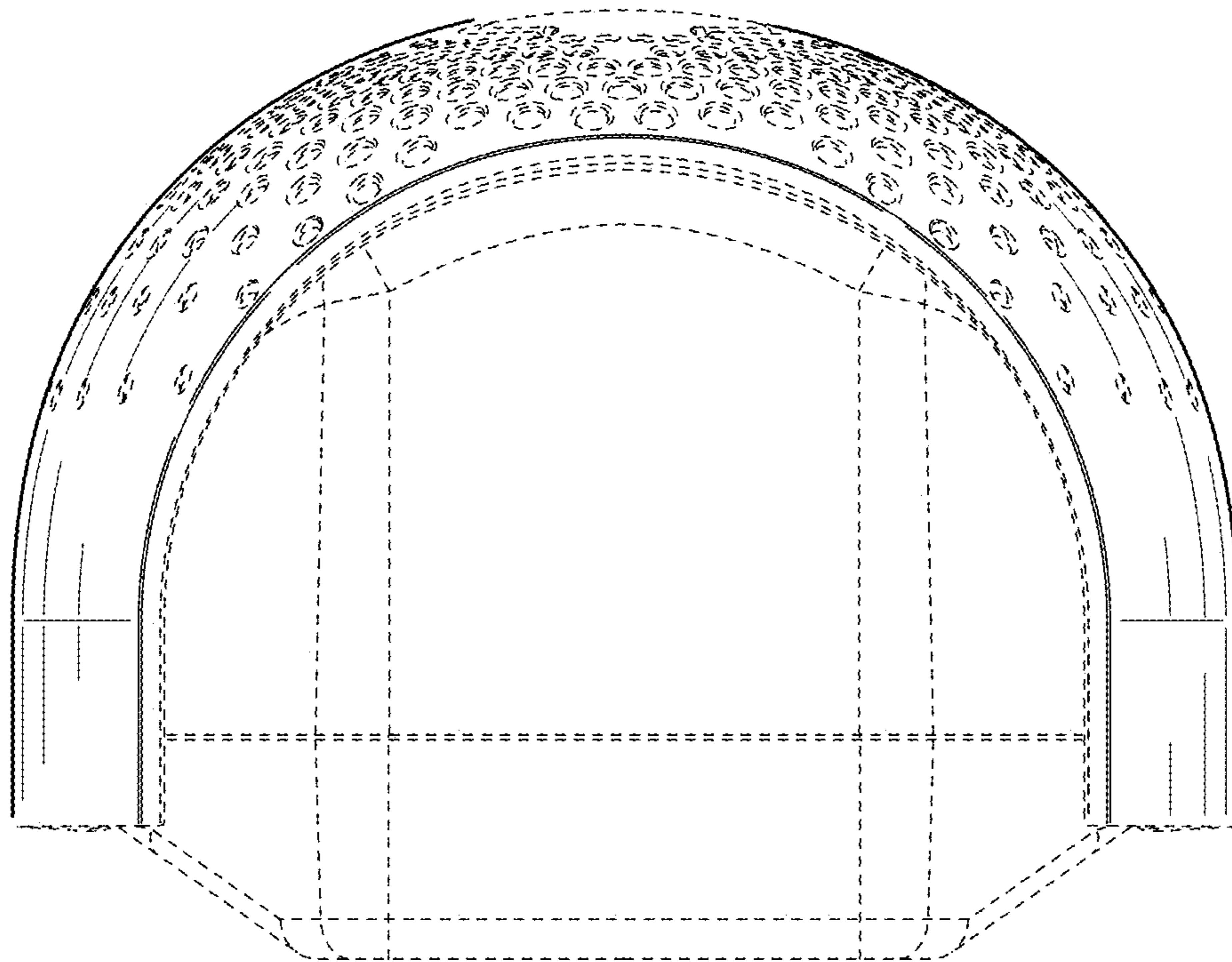

FIG. 7