



US00D872234S

(12) **United States Design Patent**  
**Stoler**

(10) **Patent No.:** **US D872,234 S**  
(45) **Date of Patent:** **\*\* Jan. 7, 2020**

(54) **FAUCET**

- (71) Applicant: **DELTA FAUCET COMPANY**,  
Indianapolis, IN (US)
- (72) Inventor: **Benjamin David Stoler**, Carmel, IN  
(US)
- (73) Assignee: **DELTA FAUCET COMPANY**,  
Indianapolis, IN (US)

(\*\*) Term: **15 Years**

(21) Appl. No.: **29/638,150**

(22) Filed: **Feb. 24, 2018**

(51) **LOC (12) Cl.** ..... **23-01**

(52) **U.S. Cl.**  
USPC ..... **D23/238**

(58) **Field of Classification Search**  
USPC ..... D23/238–240, 241–245, 249, 250–254,  
D23/255, 257, 309; D8/300, 307, 308;  
D7/394, 622, 395, 545, 398  
CPC ..... Y10T 137/9464  
See application file for complete search history.

(56) **References Cited**

**U.S. PATENT DOCUMENTS**

D216,692 S *	3/1970	Young	.....	D23/250
D279,597 S *	7/1985	Rademacher	.....	D23/250
D329,586 S *	9/1992	Primeau	.....	D8/308
D567,909 S *	4/2008	Schonherr	.....	D23/238
D573,696 S *	7/2008	Eilmus	.....	D23/255
D625,391 S *	10/2010	Soriano	.....	D23/238
D800,259 S *	10/2017	Fritz	.....	D23/238

**OTHER PUBLICATIONS**

Amazon, Kitchen Sink, posted May 7, 2017, [online], [visited Jan. 29, 2019]. Internet, <URL: [https://www.amazon.co.uk/Kitchen-CREA-Sprayer-Faucets-Brushed/dp/B06XY68WMB/ref=Ip\\_4471395031\\_1\\_5?srs=4471395031&ie=UTF8&qid=1548797929&sr=8-5&th=1](https://www.amazon.co.uk/Kitchen-CREA-Sprayer-Faucets-Brushed/dp/B06XY68WMB/ref=Ip_4471395031_1_5?srs=4471395031&ie=UTF8&qid=1548797929&sr=8-5&th=1)> (Year: 2017).\*

Faucet Guide, Delta Touch Faucet Reviews, posted Feb. 22, 2018, [online], [visited Feb. 13, 2019]. Internet, <URL: <https://www.faucetguide.net/delta-touch-faucet-reviews/>> (Year: 2018).\*

\* cited by examiner

*Primary Examiner* — Sheryl Lane

*Assistant Examiner* — Samantha N Wood

(74) *Attorney, Agent, or Firm* — Edgar A. Zarins; Nirav D. Parikh

(57) **CLAIM**

The ornamental design for a faucet, as shown and described.

**DESCRIPTION**

FIG. 1 is a first perspective view of a faucet showing my new design;  
FIG. 2 is a second perspective view thereof;  
FIG. 3 is a front elevational view thereof;  
FIG. 4 is a left side view thereof;  
FIG. 5 is a rear view thereof;  
FIG. 6 is a right side view thereof;  
FIG. 7 is a top plan view thereof; and,  
FIG. 8 is a bottom view thereof.  
The broken lines are included for the purpose of showing portions of the faucet and form no part of the claimed design.

**1 Claim, 4 Drawing Sheets**

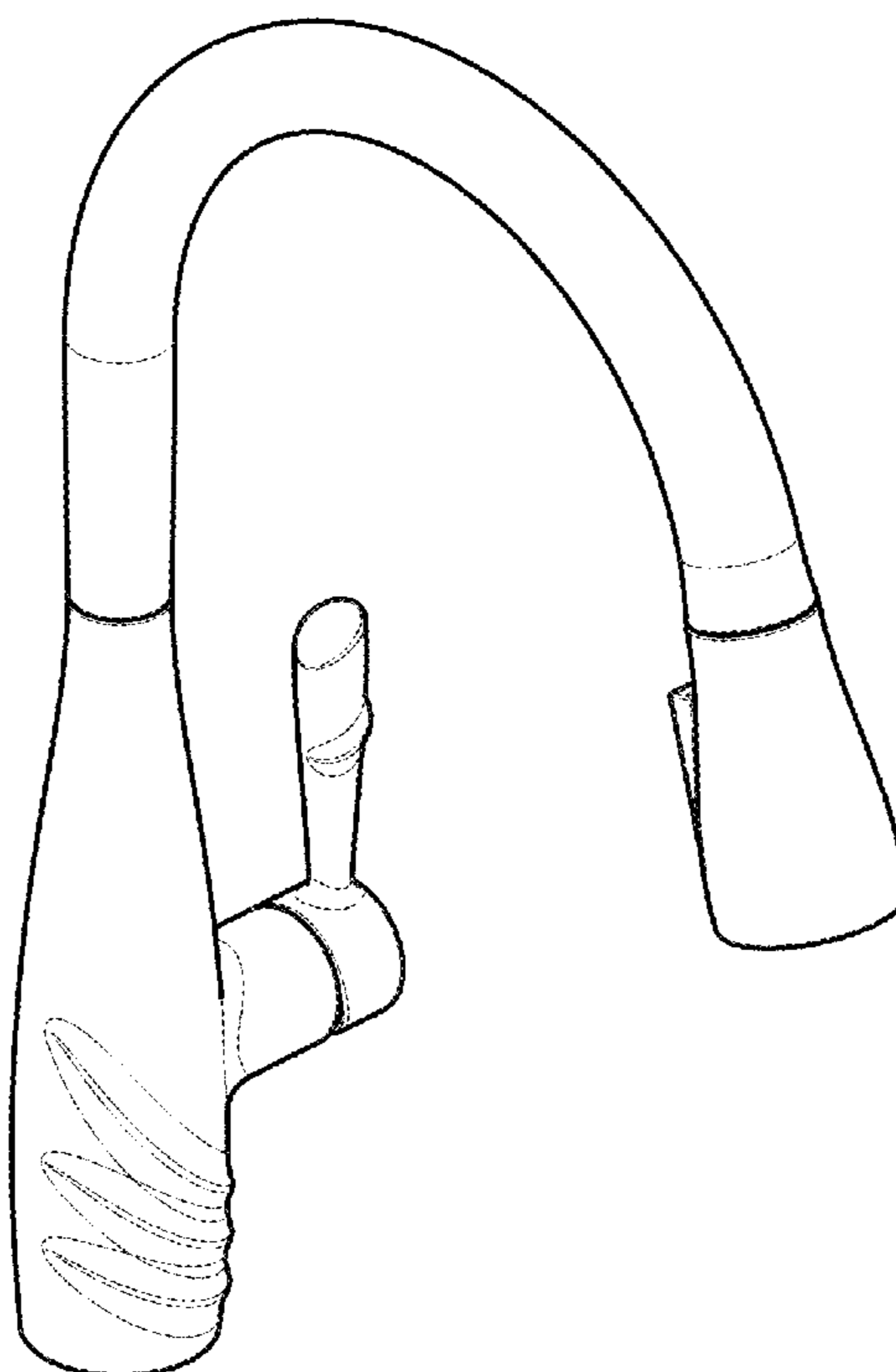

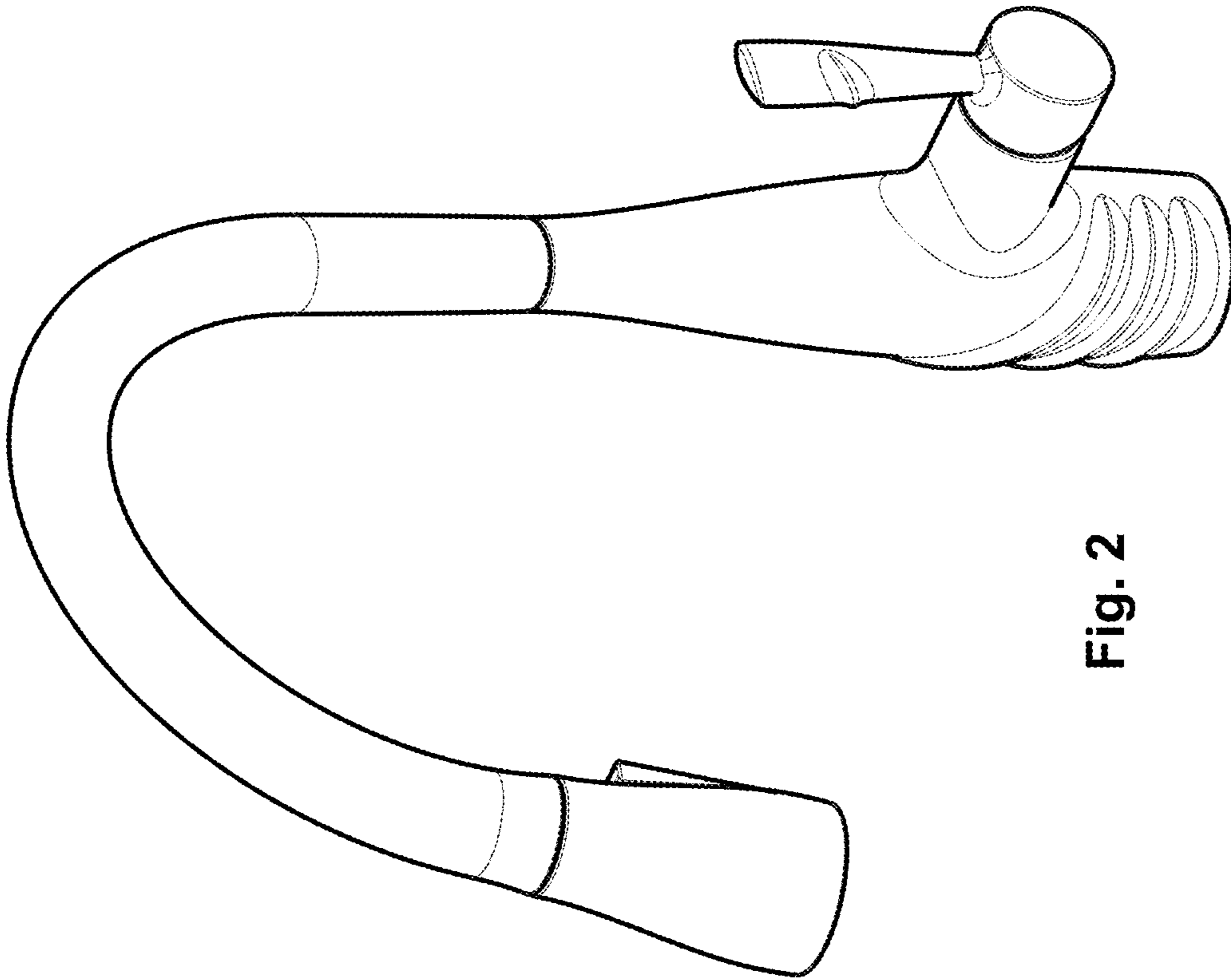

Fig. 1

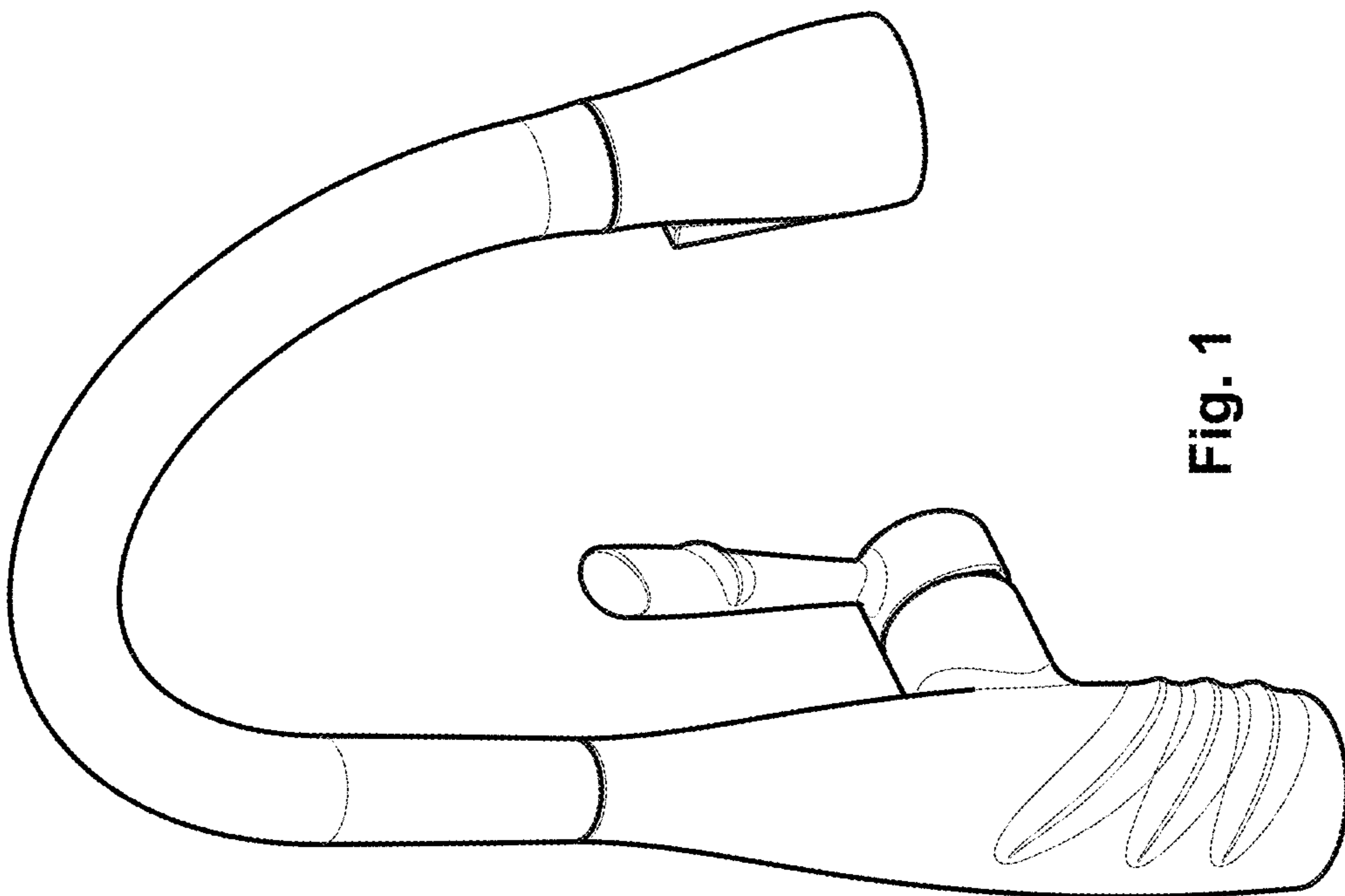

Fig. 2

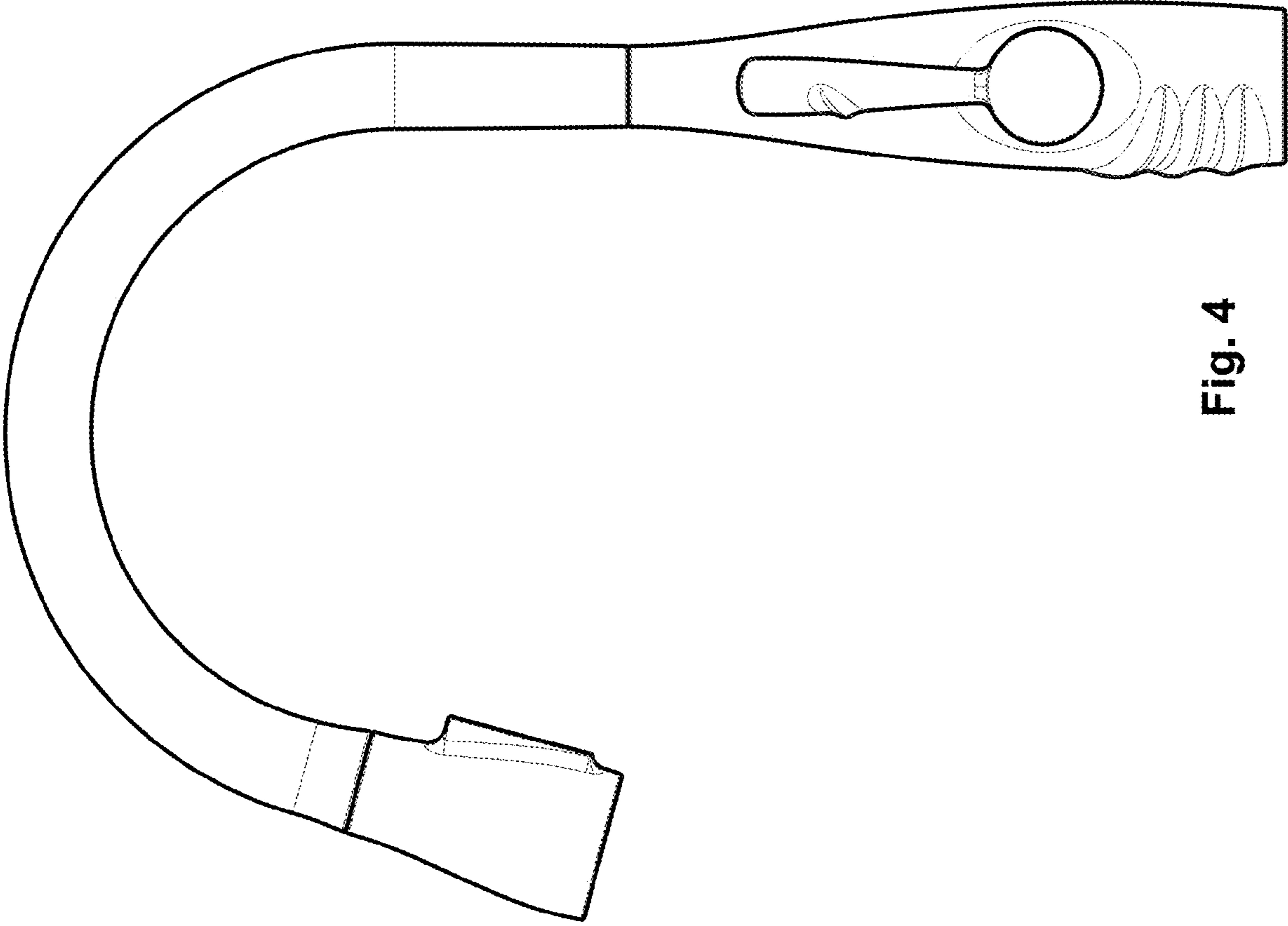

Fig. 4

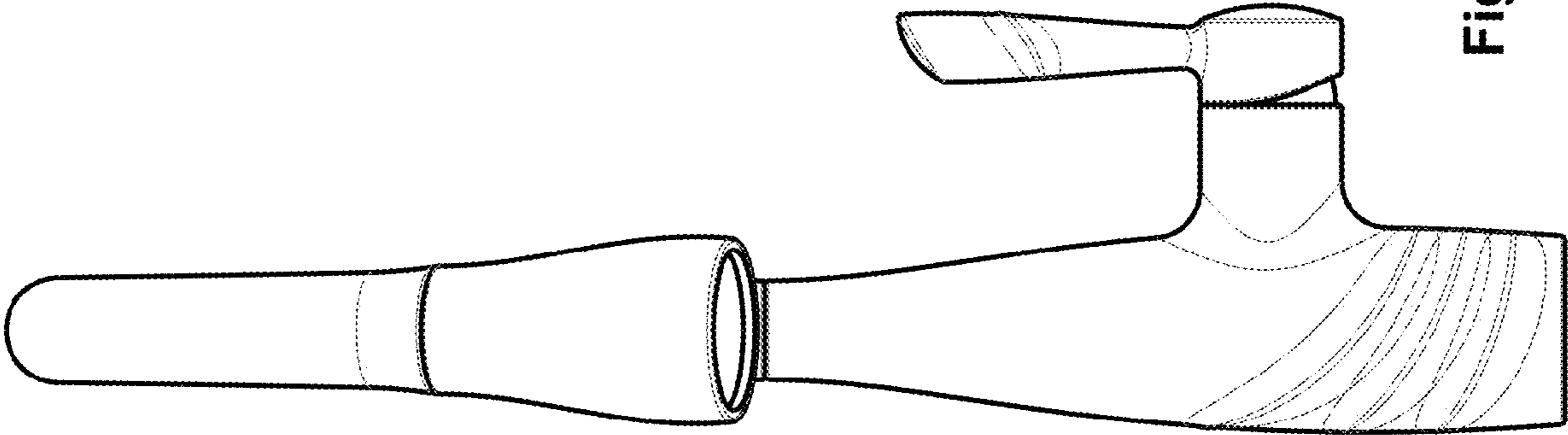

Fig. 3

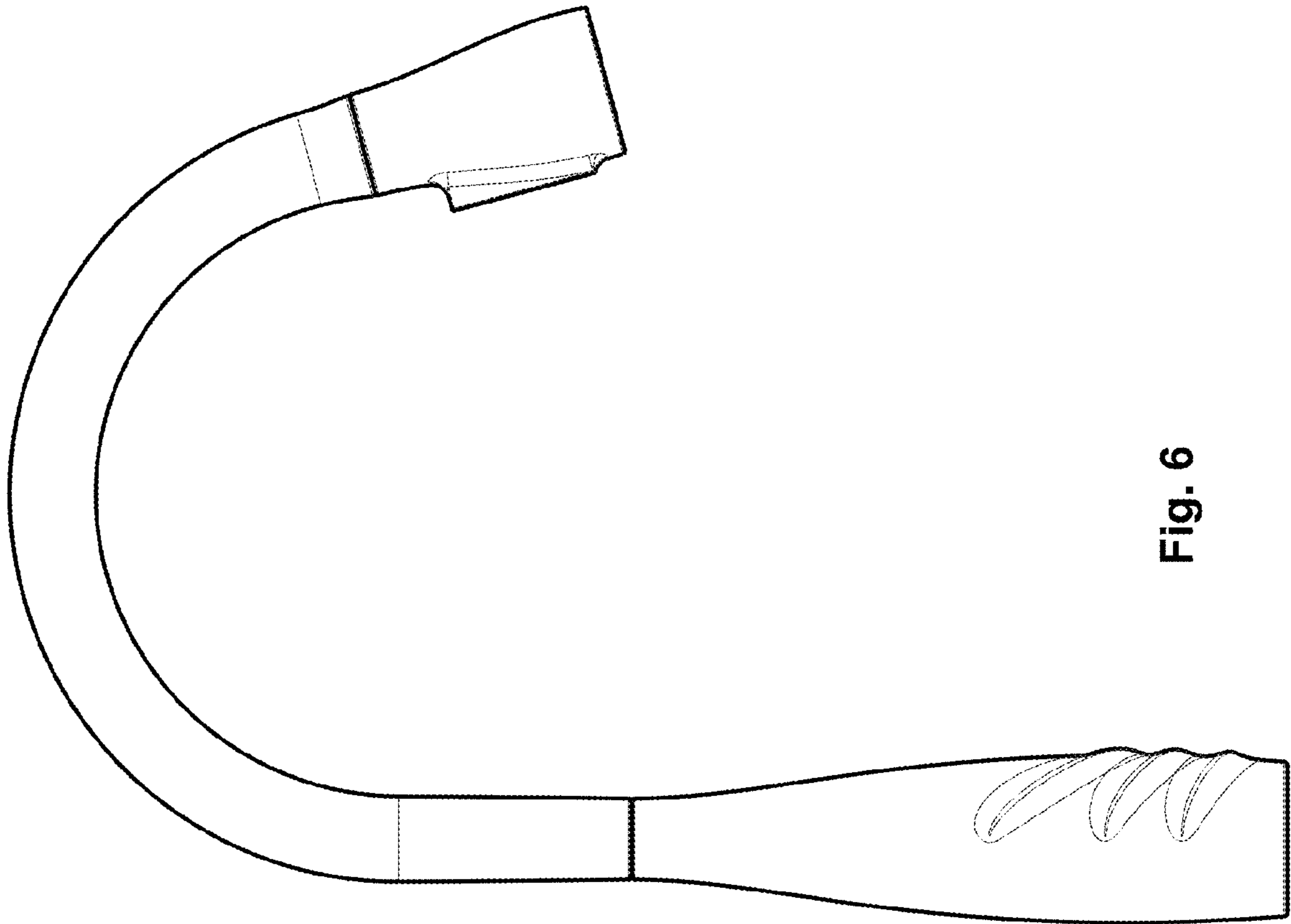

Fig. 6

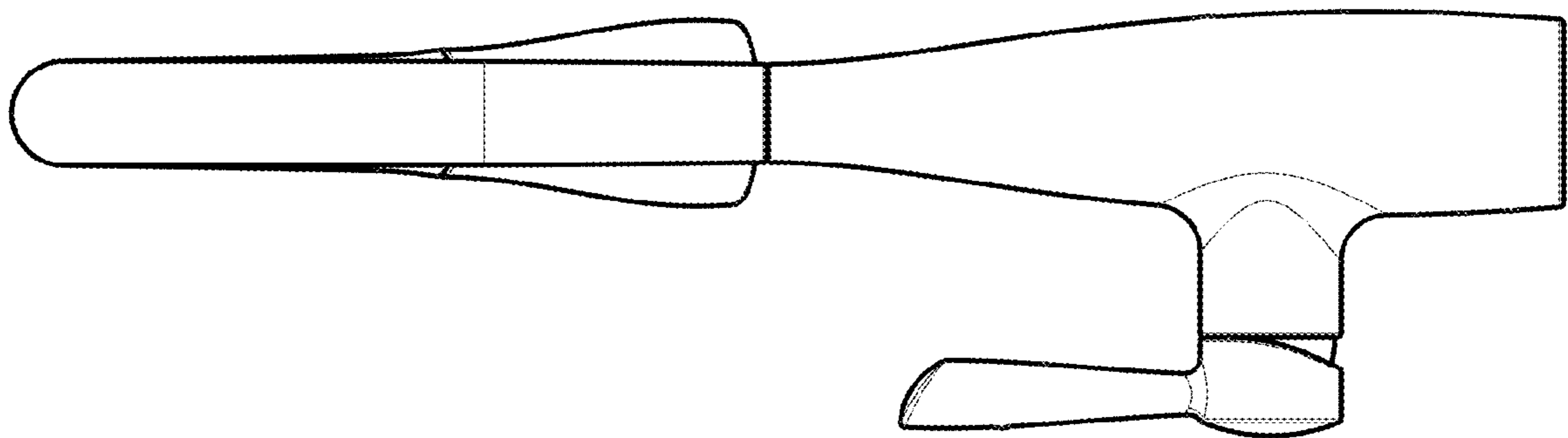

Fig. 5

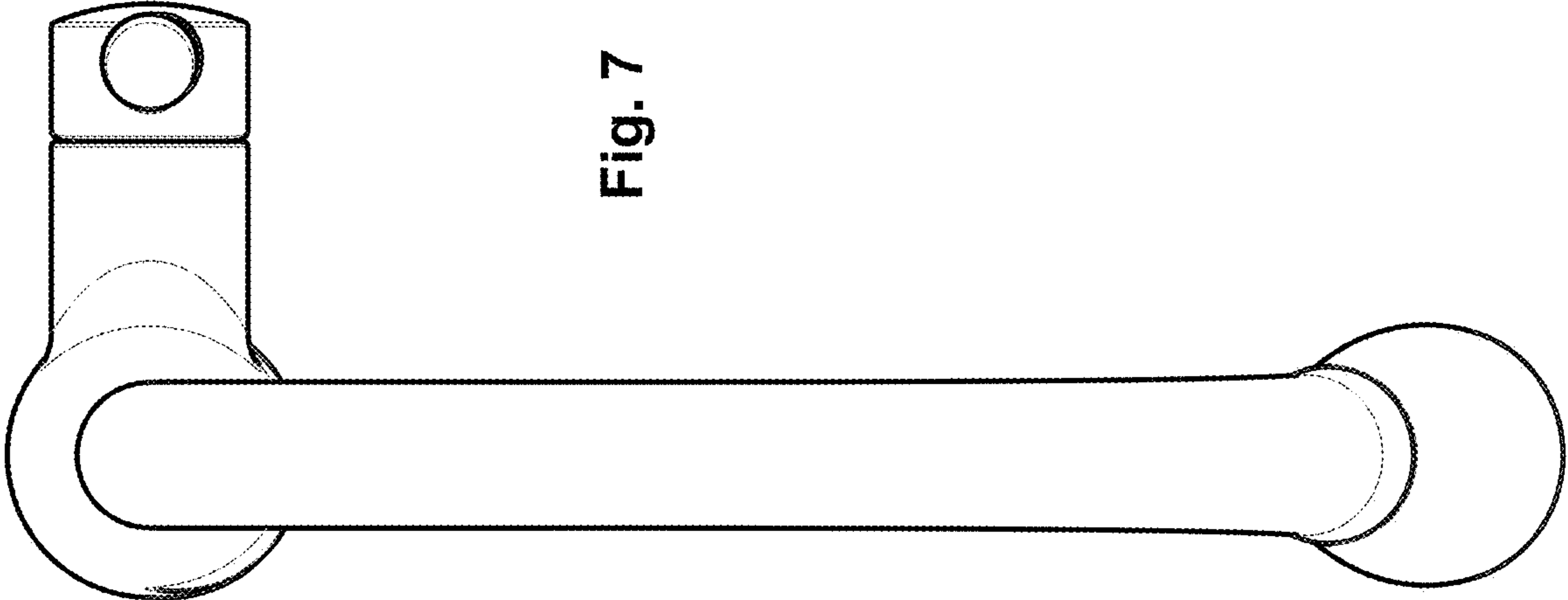

Fig. 7

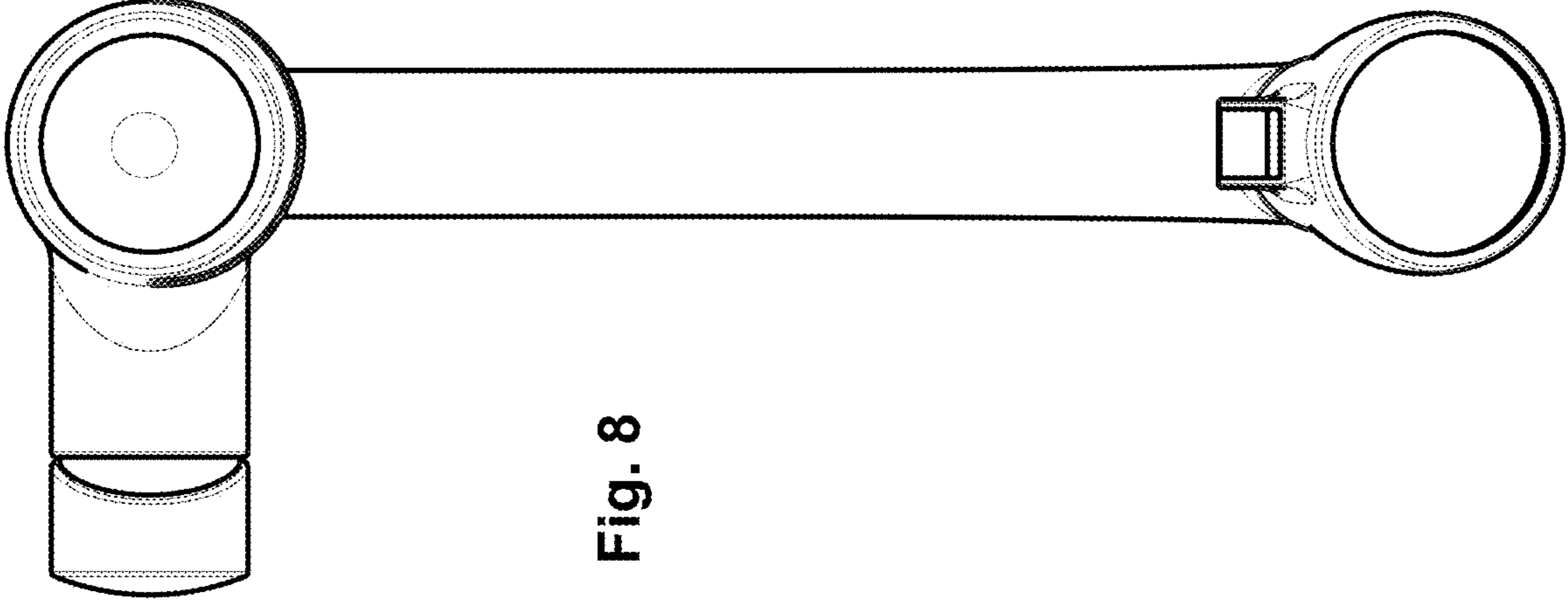

Fig. 8