



US00D872144S

(12) **United States Design Patent**
Kulig et al.

(10) **Patent No.:** **US D872,144 S**
(45) **Date of Patent:** **** Jan. 7, 2020**

- (54) **DRILL BIT**
- (71) Applicant: **Disston Company**, Chicopee, MA (US)
- (72) Inventors: **Eugene A. Kulig**, Chicopee, MA (US);
Jacky Zhang, Guangzhou (CN)
- (73) Assignee: **Disston Company**, Chicopee, MA (US)
- (**) Term: **15 Years**
- (21) Appl. No.: **29/653,029**
- (22) Filed: **Jun. 12, 2018**
- (51) **LOC (12) Cl.** **15-09**
- (52) **U.S. Cl.**
USPC **D15/139**
- (58) **Field of Classification Search**
USPC D8/20, 70, 98-99; D15/127, 133, 139,
D15/140
CPC B23B 51/02; B23B 2251/18; B23B
2251/241; B23B 2251/404; Y10T 408/04;
Y10T 408/78; Y10T 408/89; Y10T
408/909; Y10T 408/9095; Y10T 408/9097
See application file for complete search history.

(56) **References Cited**

U.S. PATENT DOCUMENTS

- 20,192 A * 5/1858 Claark B27G 15/00
408/194
- 124,089 A * 2/1872 Shepardson B23B 51/02
408/212
- 2,627,292 A * 2/1953 Konstantin B27G 15/00
408/213
- 2,782,824 A * 2/1957 Robinson B27G 15/00
408/223
- 3,997,279 A * 12/1976 Porter B27G 15/00
408/211
- D372,485 S * 8/1996 Stone D15/139
- 5,697,738 A * 12/1997 Stone B21J 5/12
408/225
- D394,663 S * 5/1998 Stone D15/139

- D408,424 S * 4/1999 Schmotzer D15/139
- D504,446 S * 4/2005 Kobayashi D15/139
- D507,585 S * 7/2005 Held D15/139
- D544,892 S * 6/2007 Watson D15/139
- D580,462 S * 11/2008 Liao D15/139

(Continued)

Primary Examiner — Patricia A Palasik

(74) *Attorney, Agent, or Firm* — K&L Gates LLP

(57) **CLAIM**

The ornamental design for a drill bit, as shown and described.

DESCRIPTION

FIG. 1 is a top, front, left side perspective view of one embodiment of a drill bit showing our new design;
 FIG. 2 is a left side view thereof;
 FIG. 3 is a top view thereof;
 FIG. 4 is a right side view thereof;
 FIG. 5 is a bottom view thereof;
 FIG. 6 is a front view thereof;
 FIG. 7 is a rear view thereof;
 FIG. 8 is an enlarged, sectioned portion highlighted in FIG. 1;
 FIG. 9 is an enlarged, sectioned portion highlighted in FIG. 2;
 FIG. 10 is a top view of the enlarged, sectioned portions of FIGS. 8 and 9;
 FIG. 11 is a right side view of the enlarged, sectioned portions of FIGS. 8 and 9;
 FIG. 12 is a bottom view of the enlarged, sectioned portions of FIGS. 8 and 9;
 FIG. 13 is a front view of the enlarged, sectioned portions of FIGS. 8 and 9; and,
 FIG. 14 is a rear view of the enlarged, sectioned portions of FIGS. 8 and 9.

The broken lines in the drawings depict portions of the drill bit that form no part of the claimed design.

1 Claim, 11 Drawing Sheets

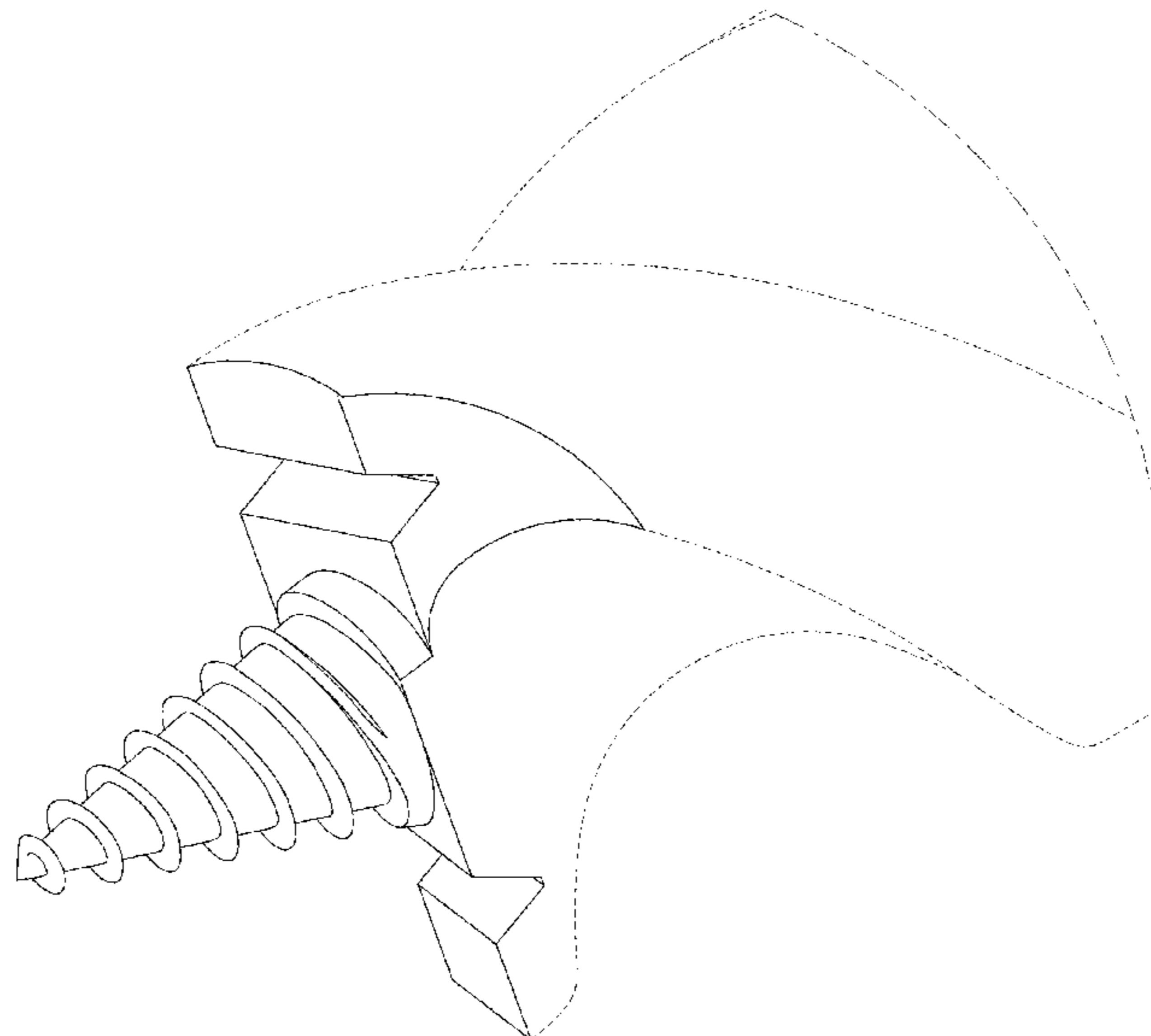

(56)

References Cited

U.S. PATENT DOCUMENTS

7,473,056 B2 * 1/2009 Durfee B23B 51/0009
408/211
D585,920 S * 2/2009 Liao D15/139
D608,801 S * 1/2010 Evatt D15/139
D608,802 S * 1/2010 Ibarra D15/139
D627,805 S * 11/2010 Dost D15/139
2003/0035694 A1 * 2/2003 Liao B27G 15/00
408/214
2007/0172325 A1 * 7/2007 Ebert B23B 51/0426
408/227

* cited by examiner

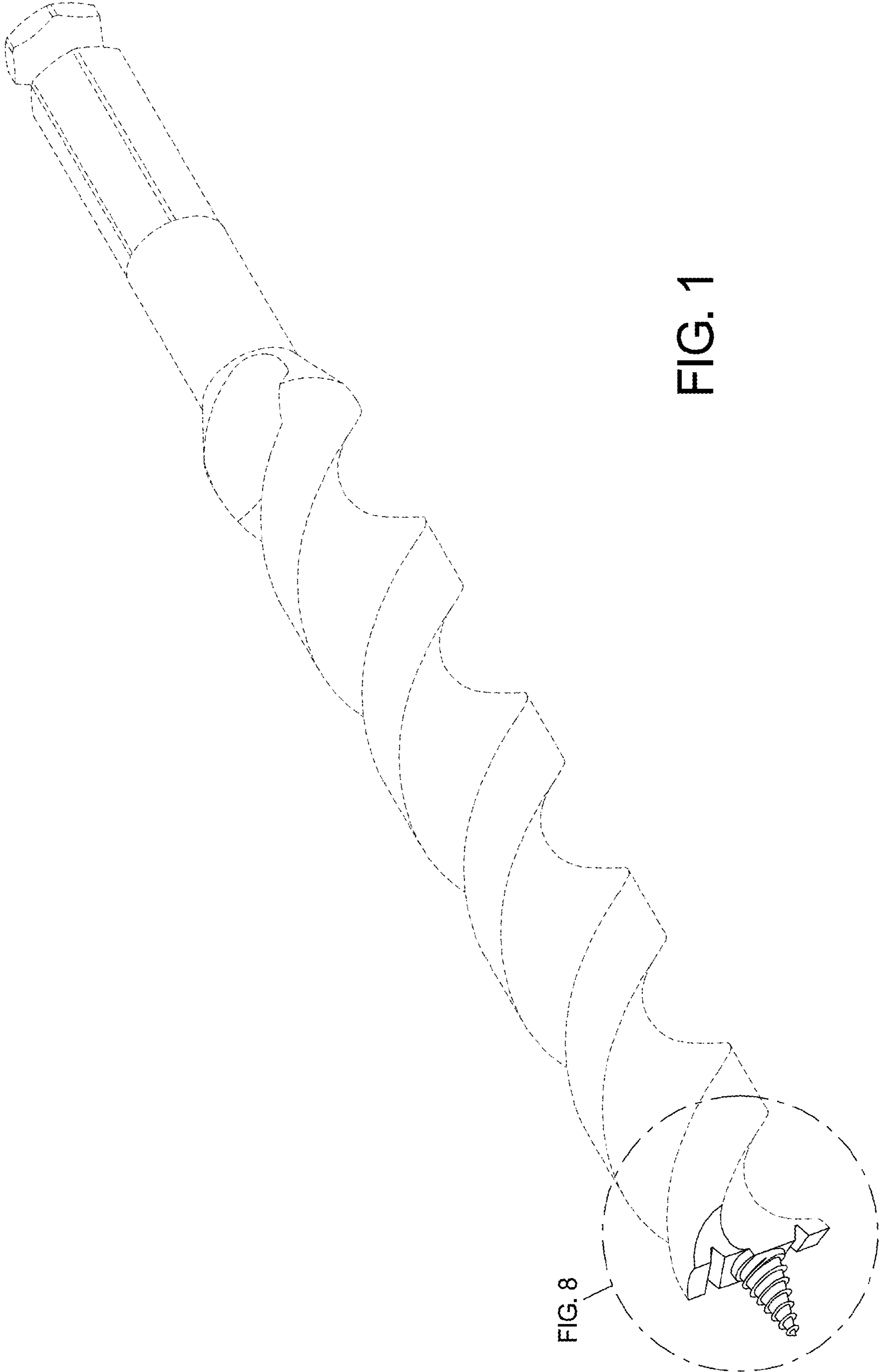
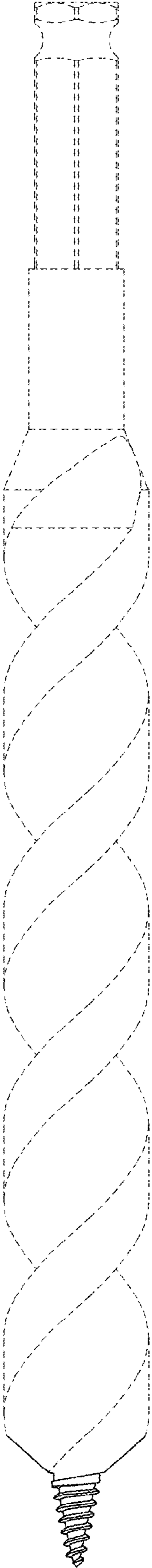
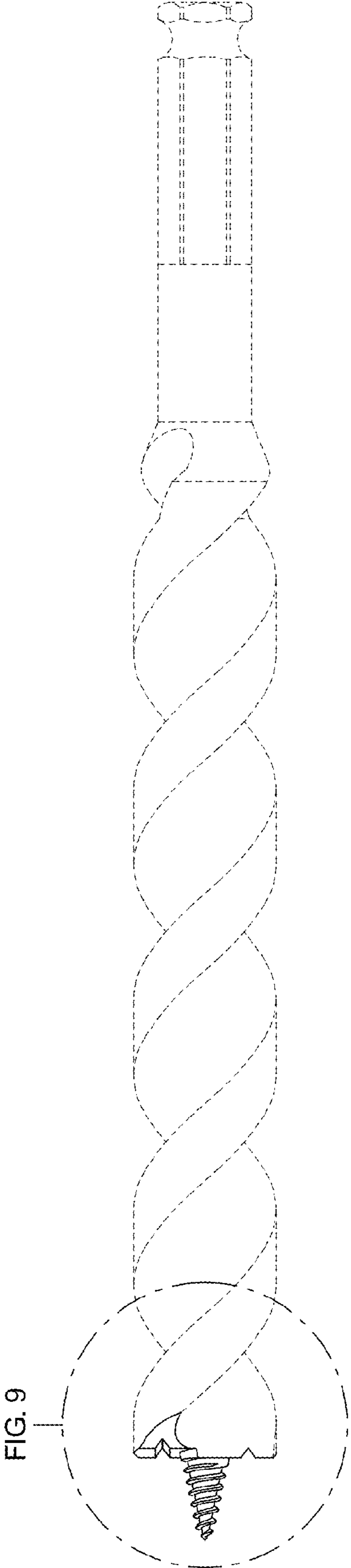

FIG. 1

FIG. 8



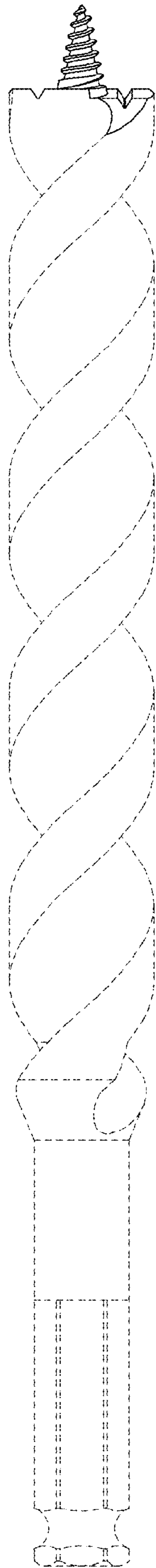

FIG. 4

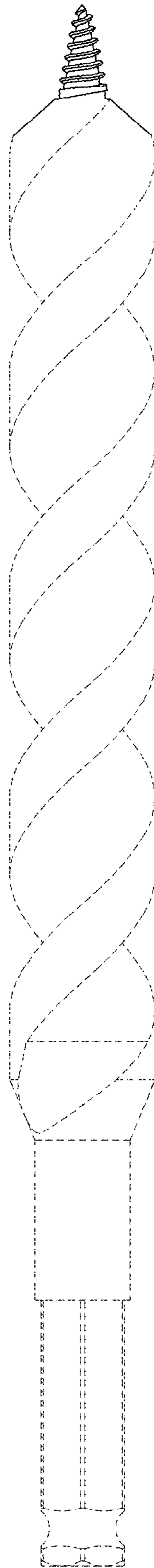

FIG. 5

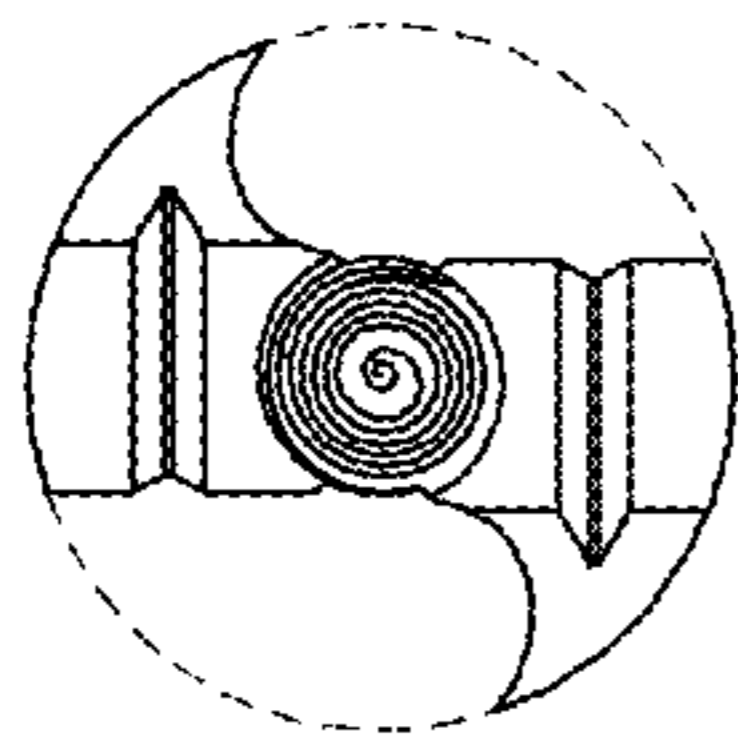

FIG. 6

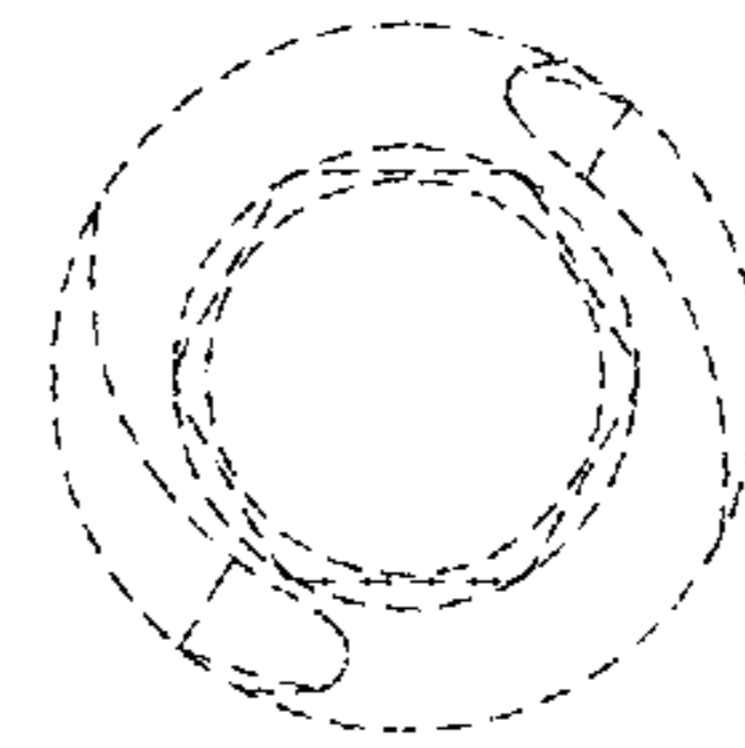

FIG. 7

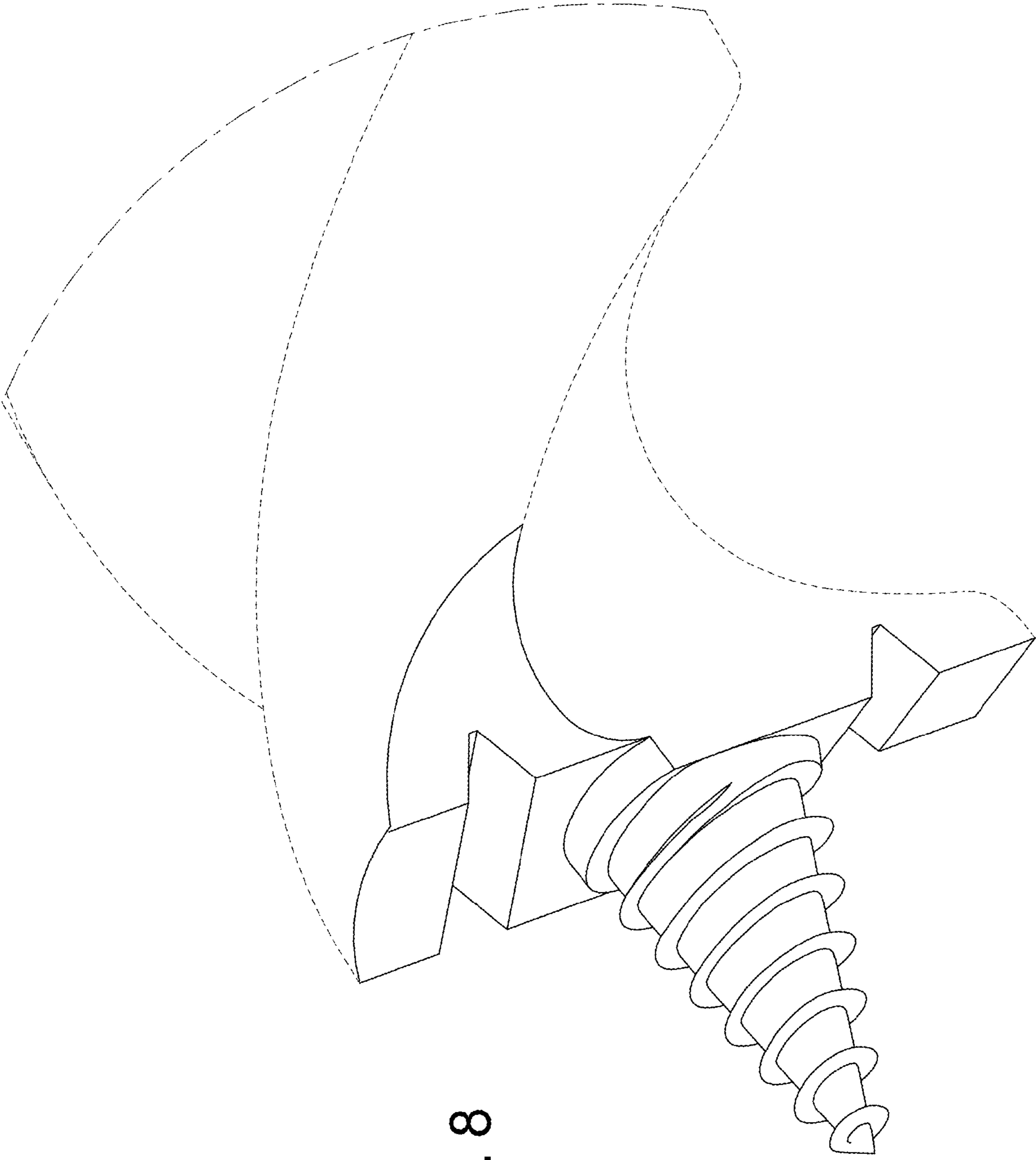

FIG. 8

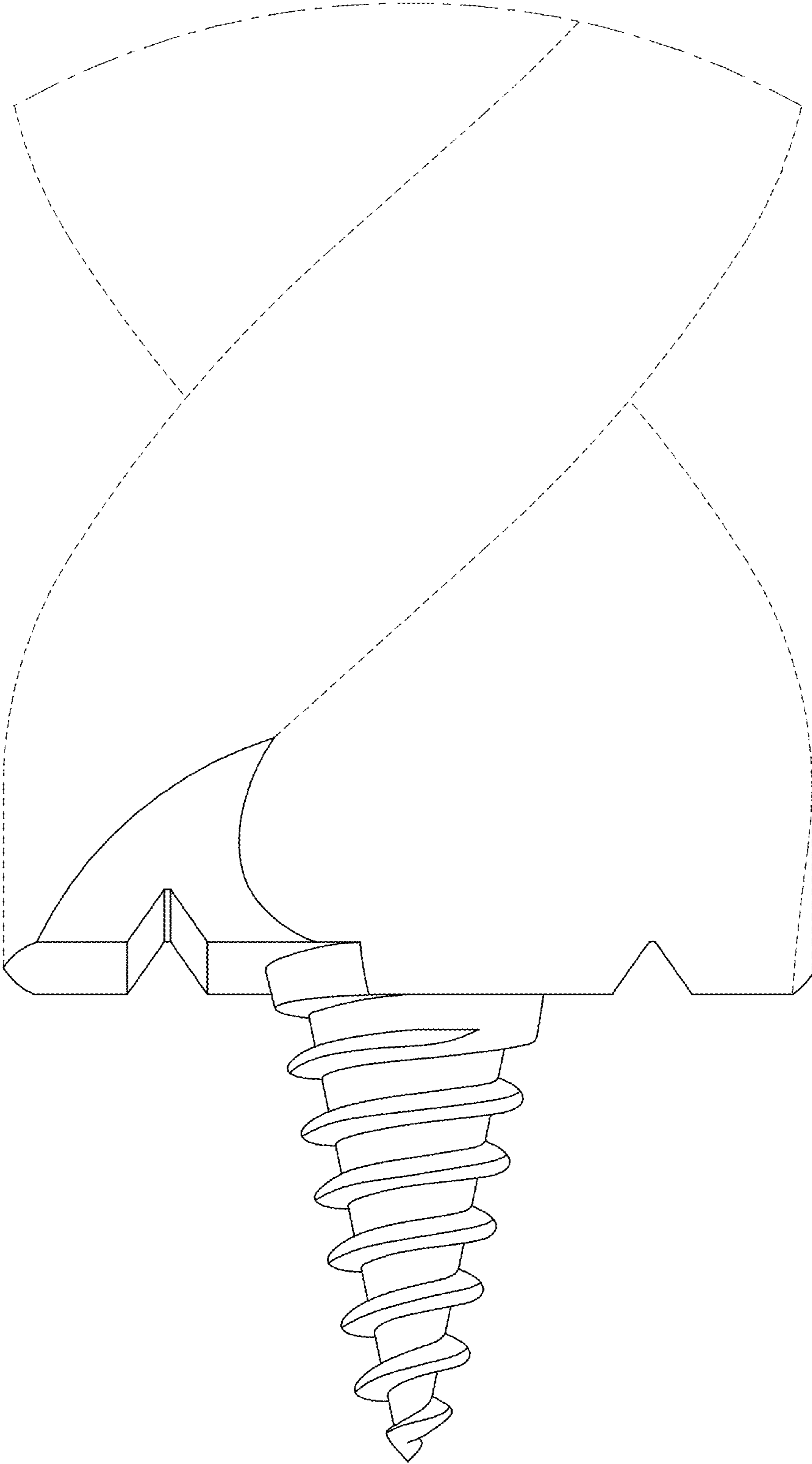

FIG. 9

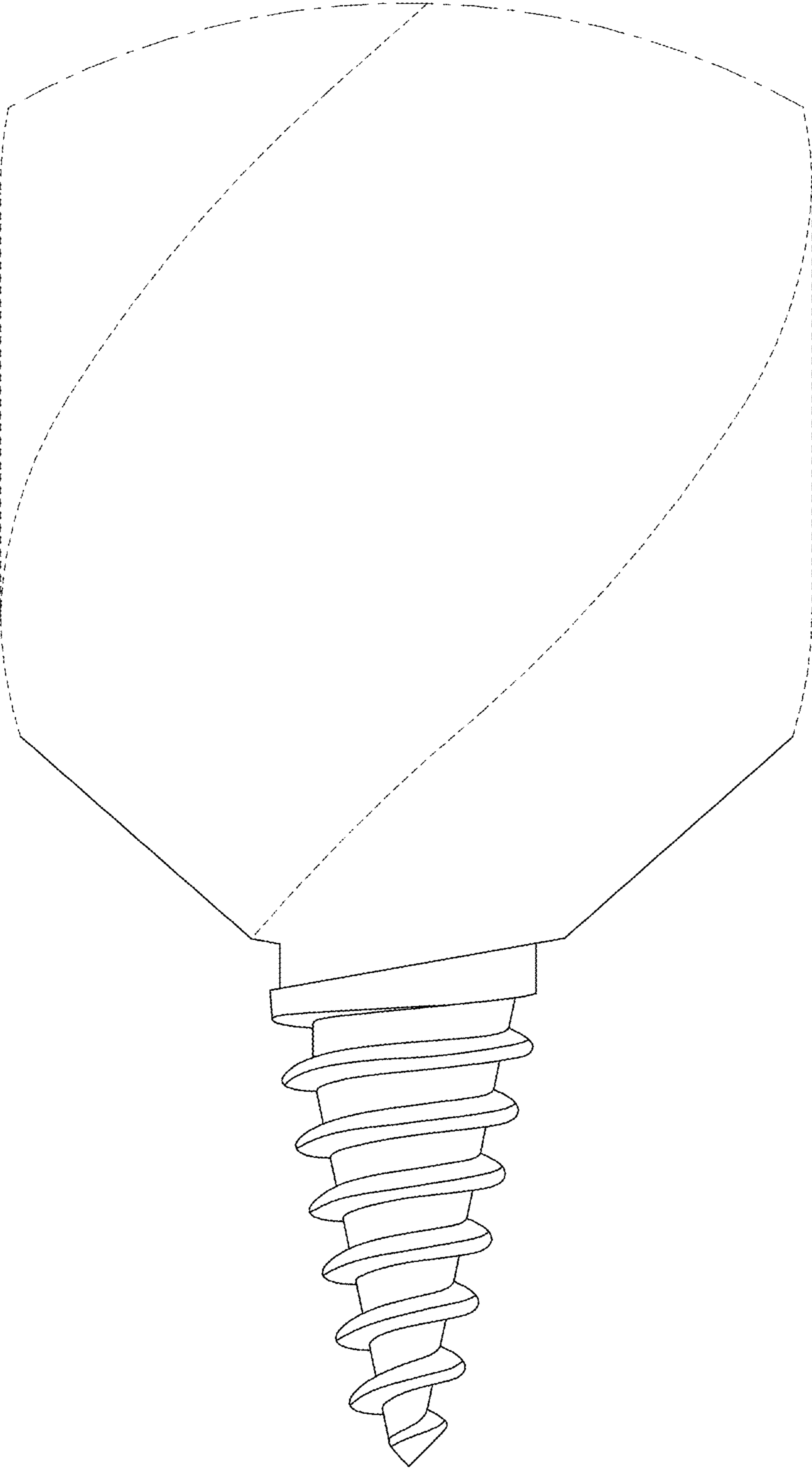

FIG. 10

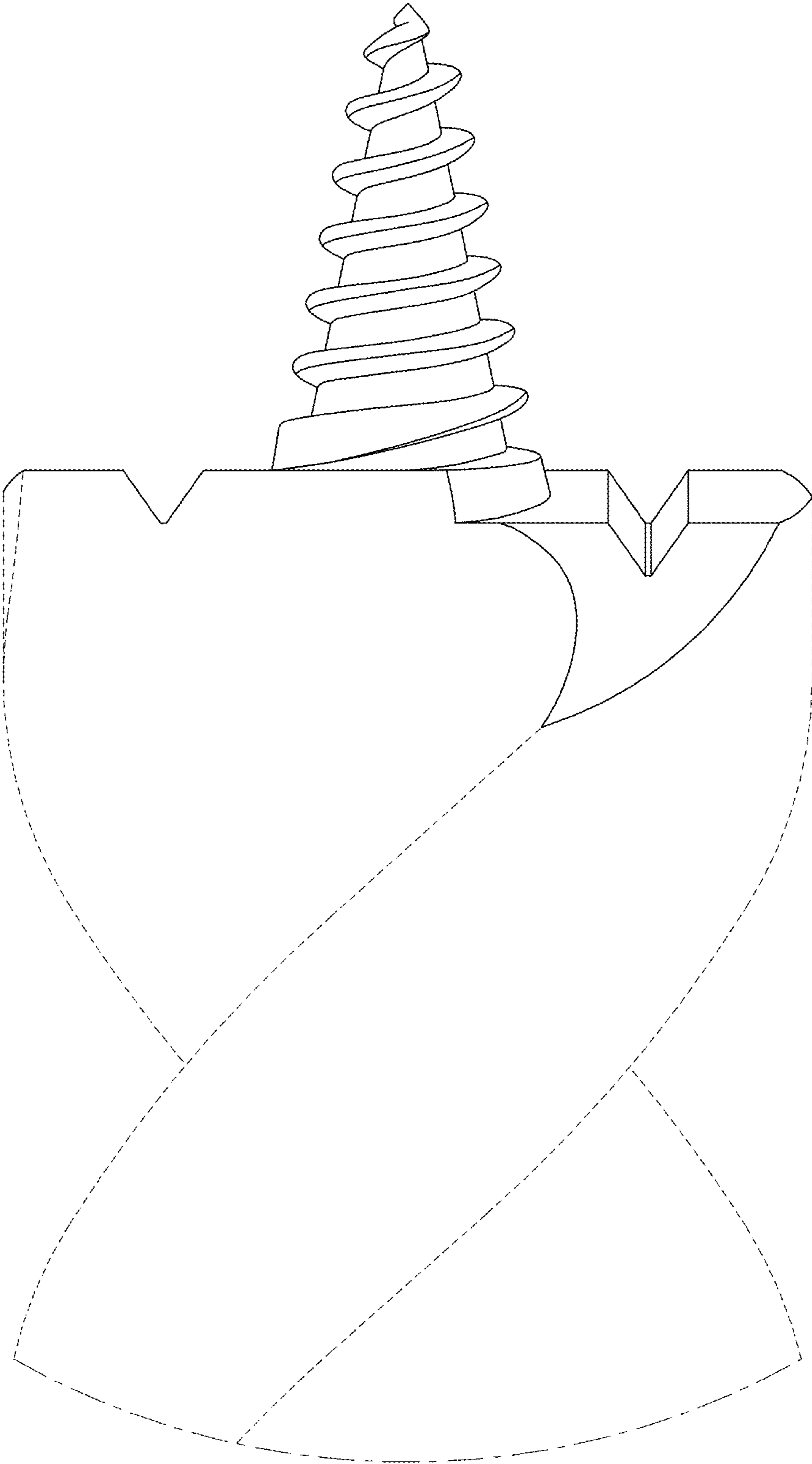

FIG. 11

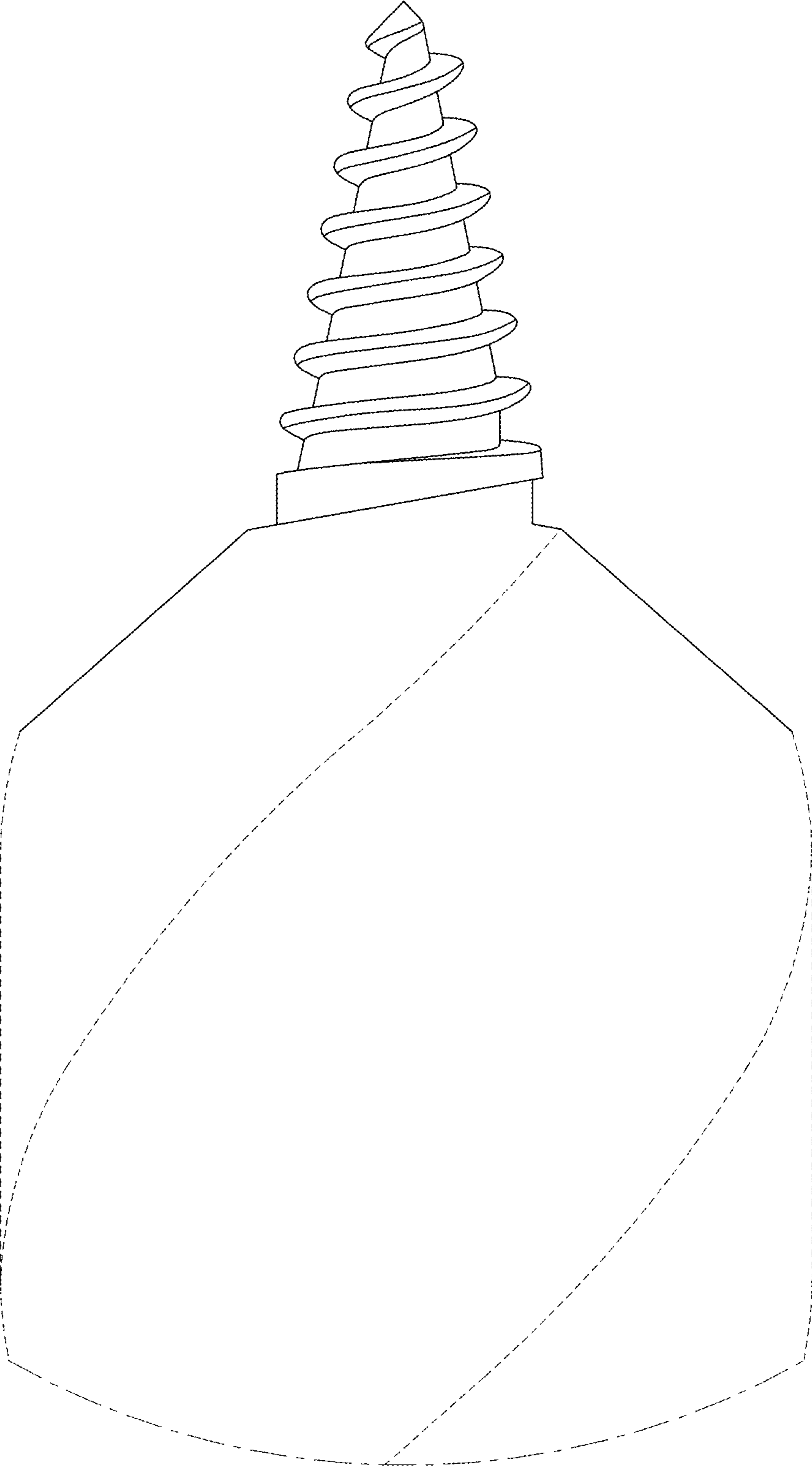

FIG. 12

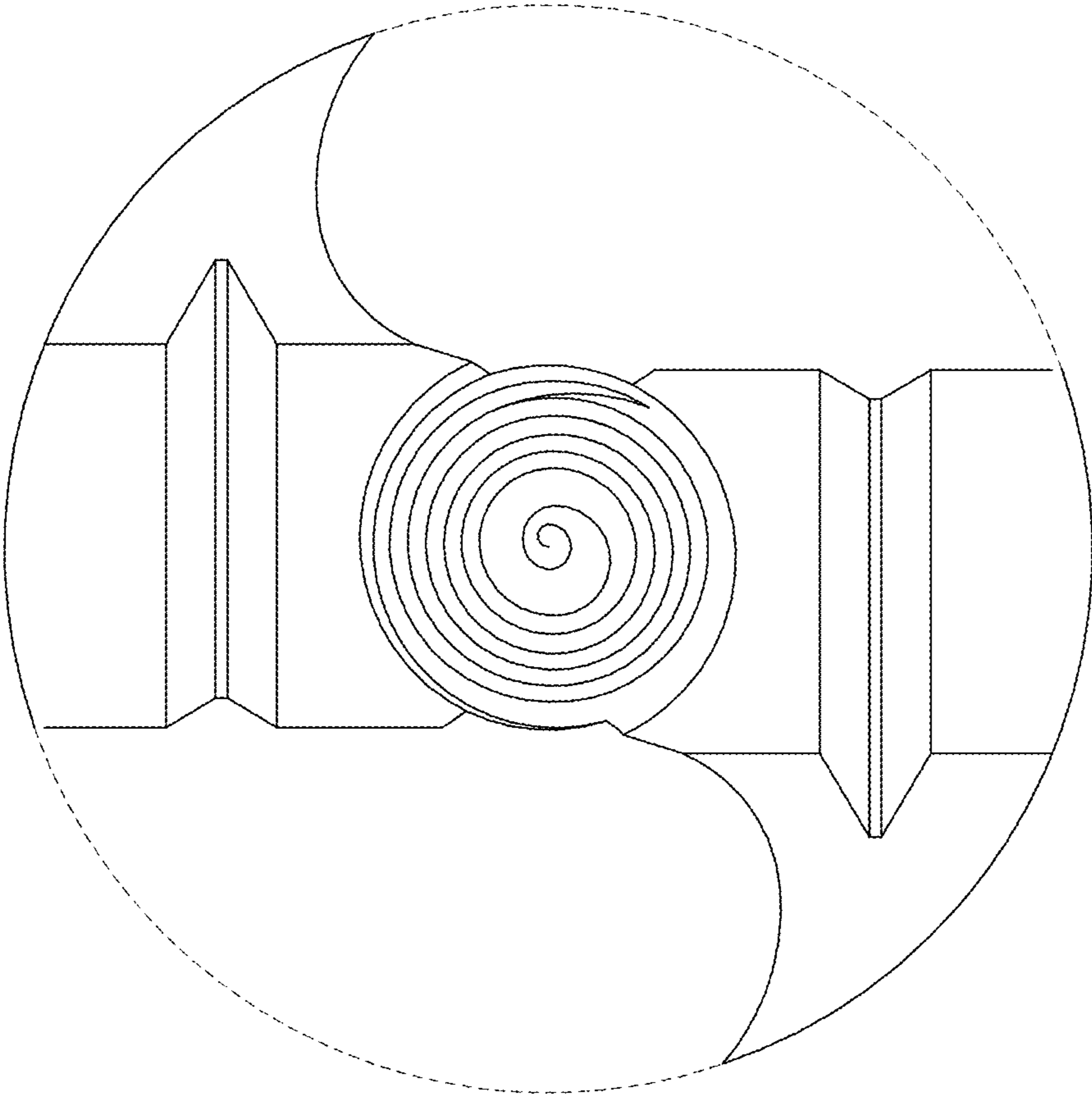

FIG. 13

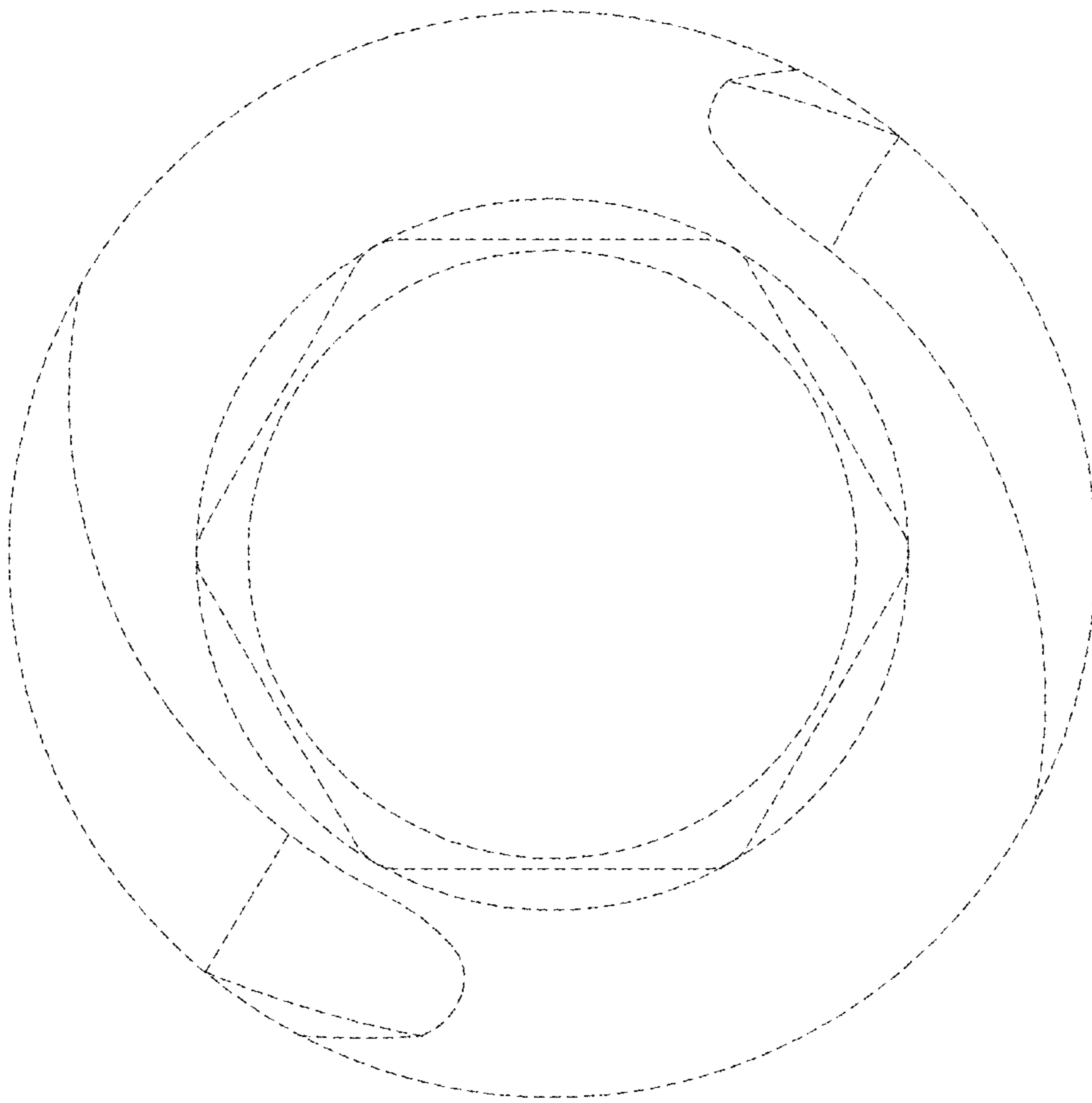

FIG. 14