



US00D872060S

(12) **United States Design Patent**
Briggs et al.

(10) **Patent No.:** **US D872,060 S**
(45) **Date of Patent:** **** Jan. 7, 2020**

- (54) **EARPIECE STABILIZER**
- (71) Applicant: **New Audio LLC**, New York, NY (US)
- (72) Inventors: **Drew Stone Briggs**, Brooklyn, NY (US); **Nicholas Slaney**, Jersey City, NJ (US); **Thomas C. Wilson**, Brooklyn, NY (US); **Marten Wallby**, Malmo (SE)
- (73) Assignee: **New Audio LLC**, New York, NY (US)

(**) Term: **15 Years**

(21) Appl. No.: **29/647,397**

(22) Filed: **May 11, 2018**

(51) **LOC (12) Cl.** **14-01**

(52) **U.S. Cl.**
USPC **D14/223**

(58) **Field of Classification Search**
USPC ... D14/205, 207, 217, 221, 223, 224, 224.1, D14/225, 204, 209, 209.1, 210, 211, 212, D14/213, 214, 215, 216, 222; D24/173, D24/174
CPC H04R 1/10; H04R 1/1016; H04R 1/1066; H04R 1/105; H04R 1/1033; H04R 1/08; H04R 1/02; H04R 1/021; H04R 1/023; H04R 5/033; H04R 5/0335; H04R 5/00; H04R 25/00

See application file for complete search history.

(56) **References Cited**

U.S. PATENT DOCUMENTS

D728,532 S *	5/2015	Kurtz	D14/223
D779,461 S *	2/2017	Smith	D14/223
D825,533 S *	8/2018	Paschke	D14/223
D839,237 S *	1/2019	Mei	D14/205
D843,352 S *	3/2019	Lee	D14/223
2011/0255729 A1 *	10/2011	Tan	H04R 1/105 381/380

2015/0156579 A1 *	6/2015	Lowry	H04R 1/1016 381/380
2018/0338194 A1 *	11/2018	Yu	H04R 1/1016
2019/0200112 A1 *	6/2019	Briggs	H04R 1/1016

FOREIGN PATENT DOCUMENTS

WO WO-2010031775 A1 * 3/2010 H04R 1/105

OTHER PUBLICATIONS

JLab Epic Executive Wireless, posted Mar. 6, 2018 [online], retrieved Aug. 28, 2019, retrieved from internet, <https://www.pcmag.com/review/359458/jlab-epic-executive-wireless>.*

Jary NMotion Sport Wireless Bluetooth 4.0 Earbuds Review, posted May 6, 2015 [online], retrieved Aug. 28, 2019, retrieved from internet, <https://nerdtechy.com/jarv-nmotion-sport-wireless-bluetooth-4-0-earbuds-headphones-review>.*

* cited by examiner

Primary Examiner — Barbara Fox

Assistant Examiner — Messina L Smith

(74) *Attorney, Agent, or Firm* — Perkins Coie LLP

(57) **CLAIM**

The ornamental design for an earpiece stabilizer, as shown and described.

DESCRIPTION

FIG. 1 is a top, front perspective view of an earpiece stabilizer showing our new design;
 FIG. 2 is a first side elevational view thereof;
 FIG. 3 is an opposite second side elevational view thereof;
 FIG. 4 is a front elevational view thereof;
 FIG. 5 is a back elevational view thereof;
 FIG. 6 is a top plan view thereof; and,
 FIG. 7 is a bottom plan view thereof.

1 Claim, 2 Drawing Sheets

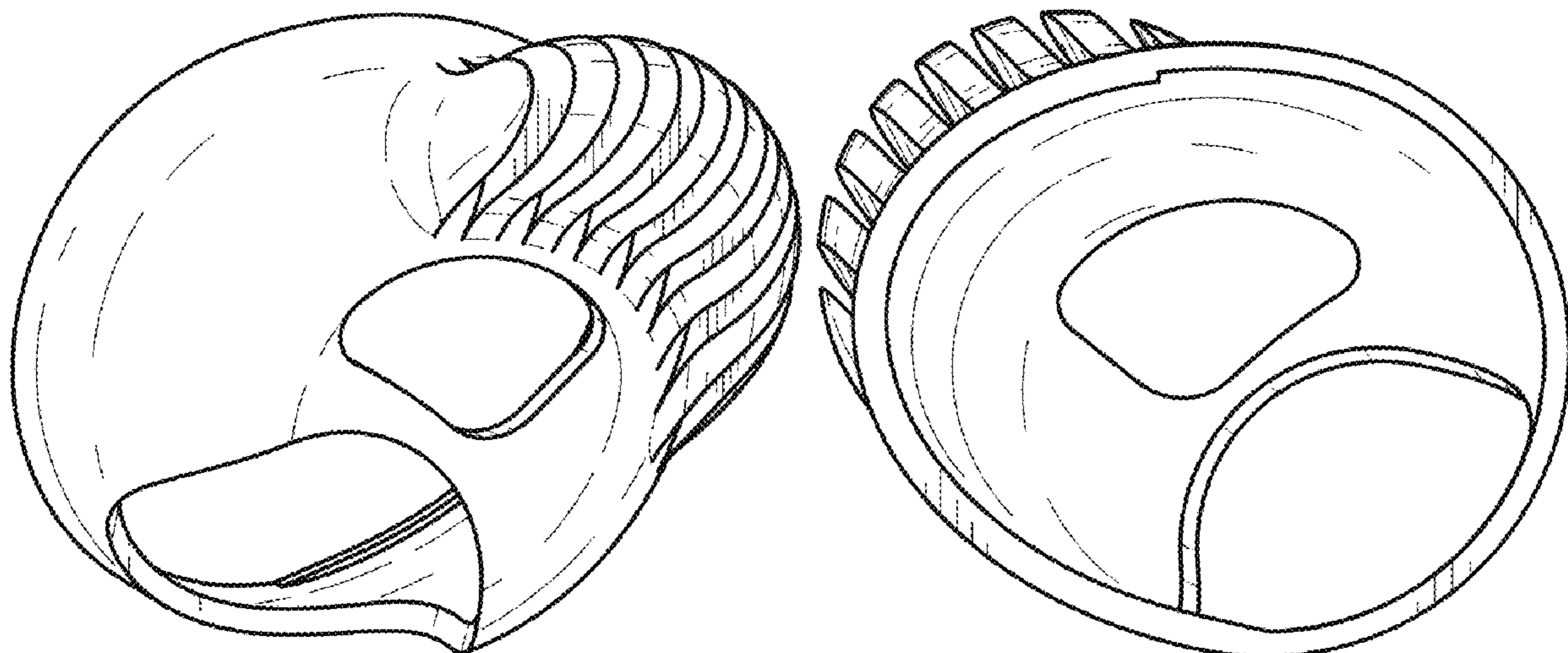

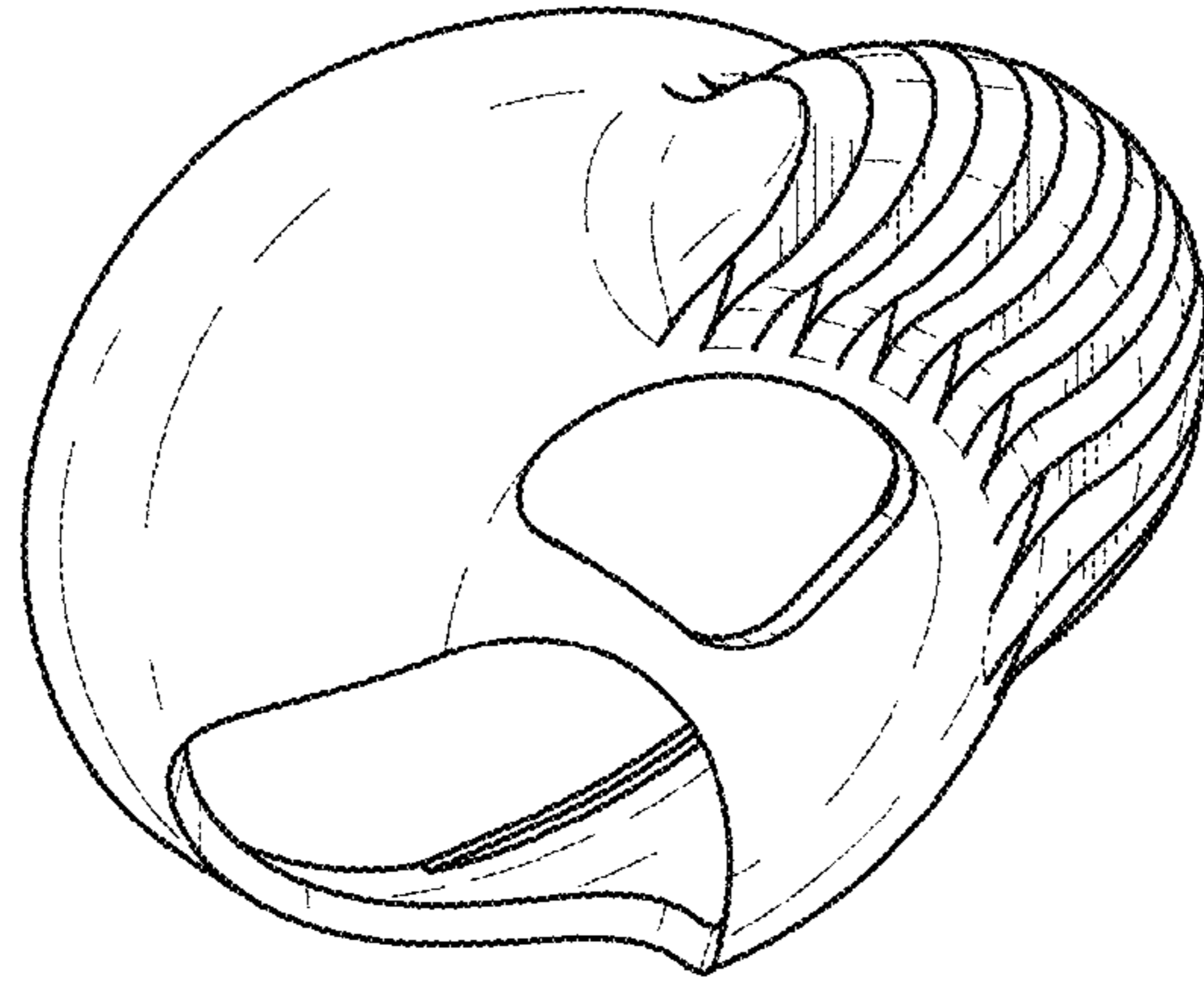

Fig. 1

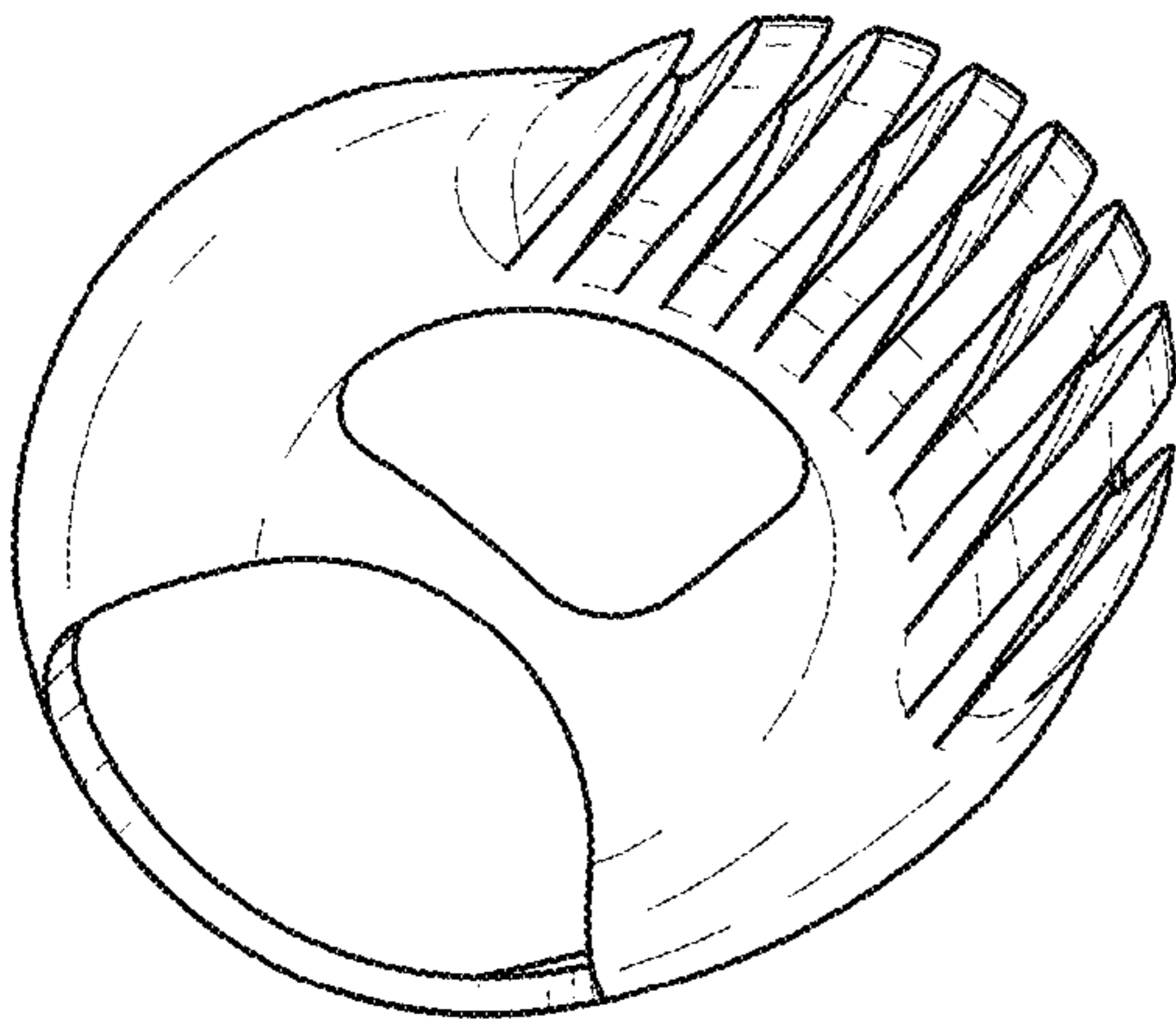

Fig. 2

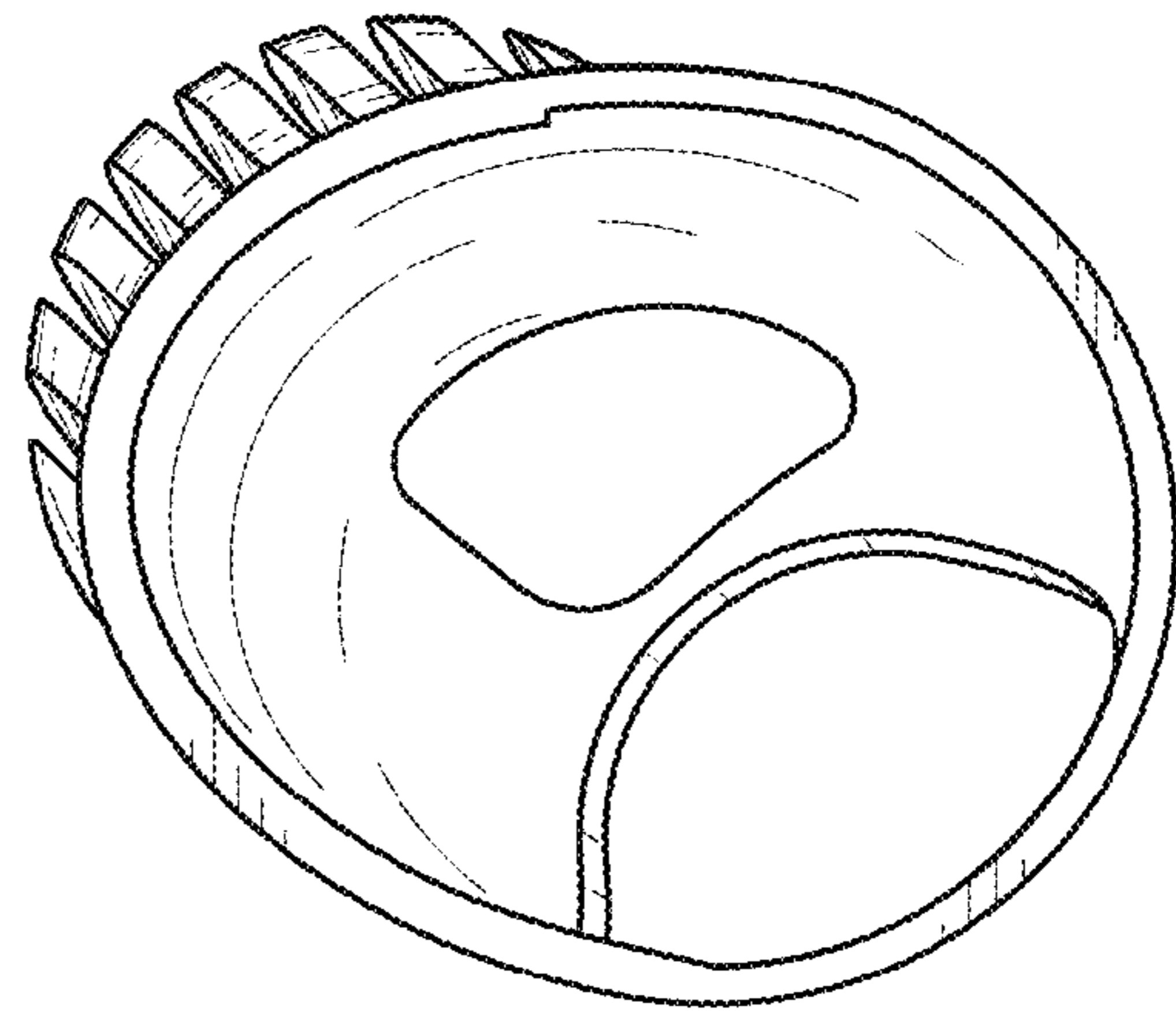

Fig. 3

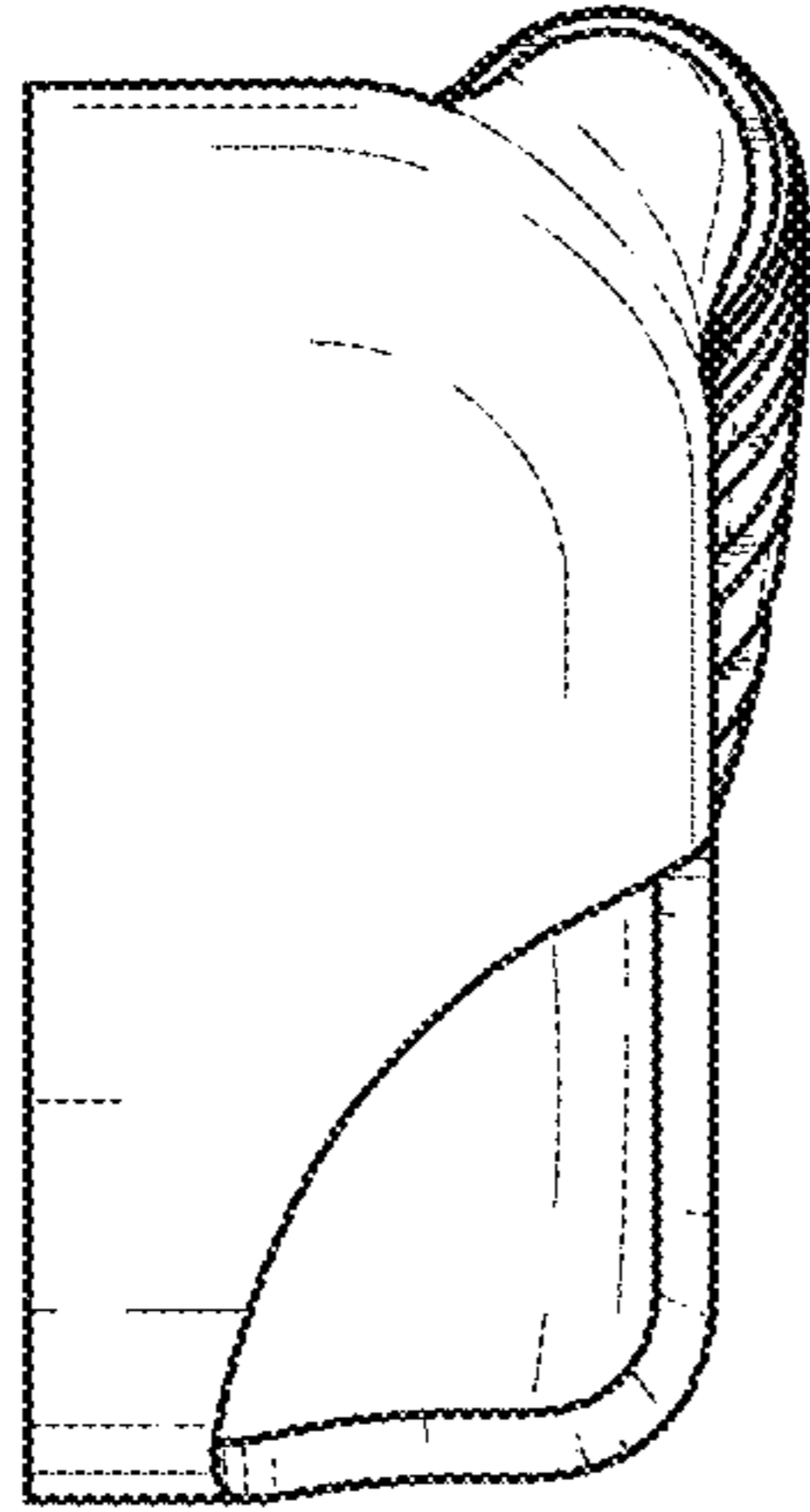

Fig. 4

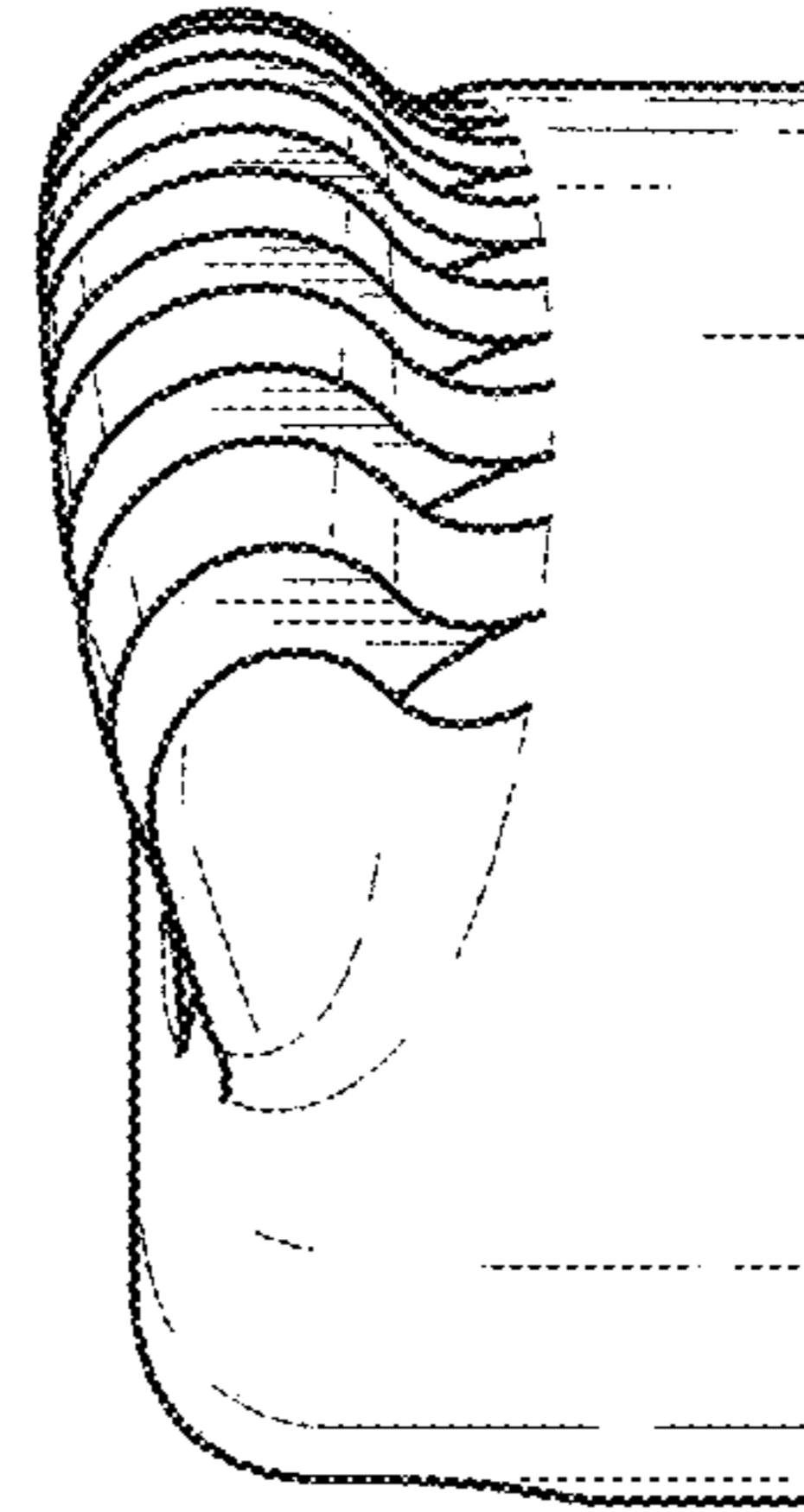

Fig. 5

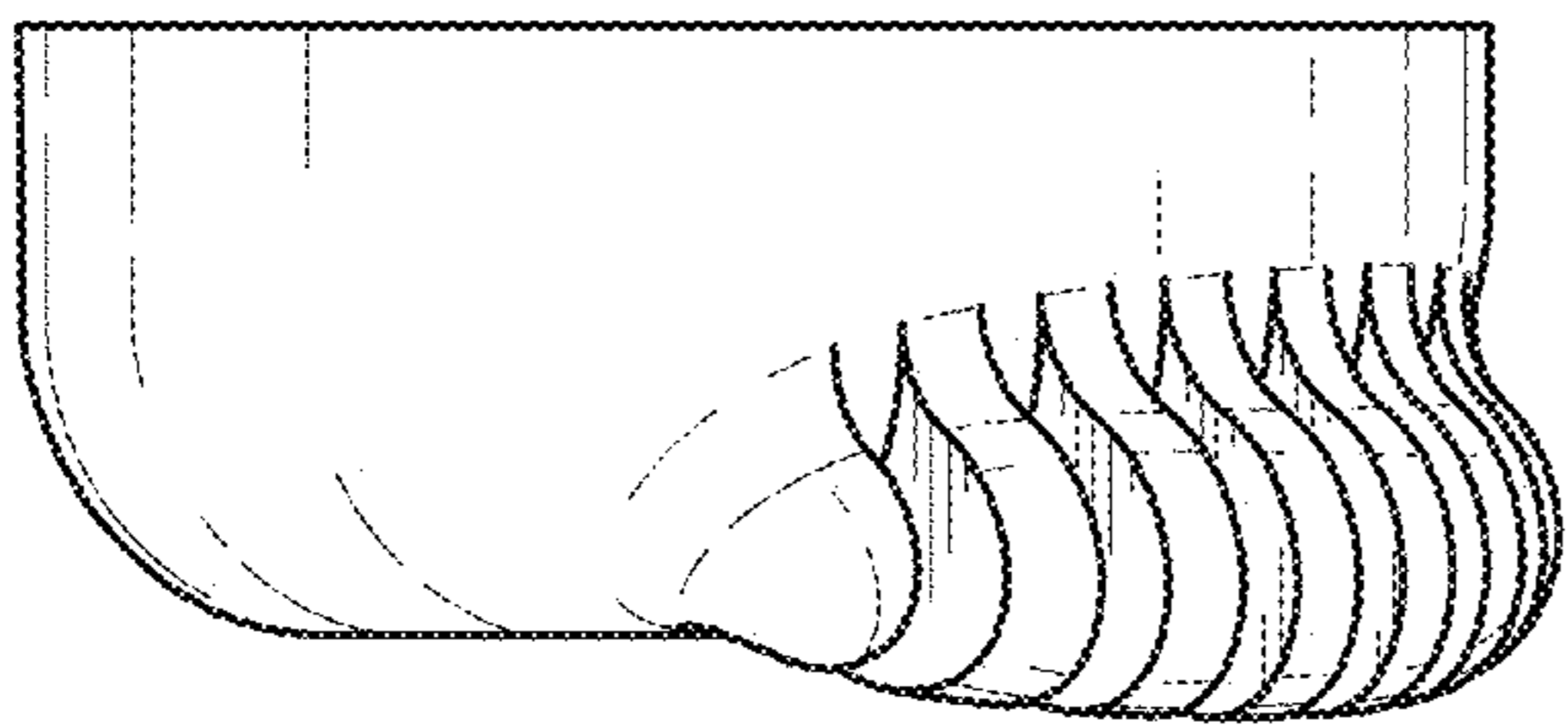

Fig. 6

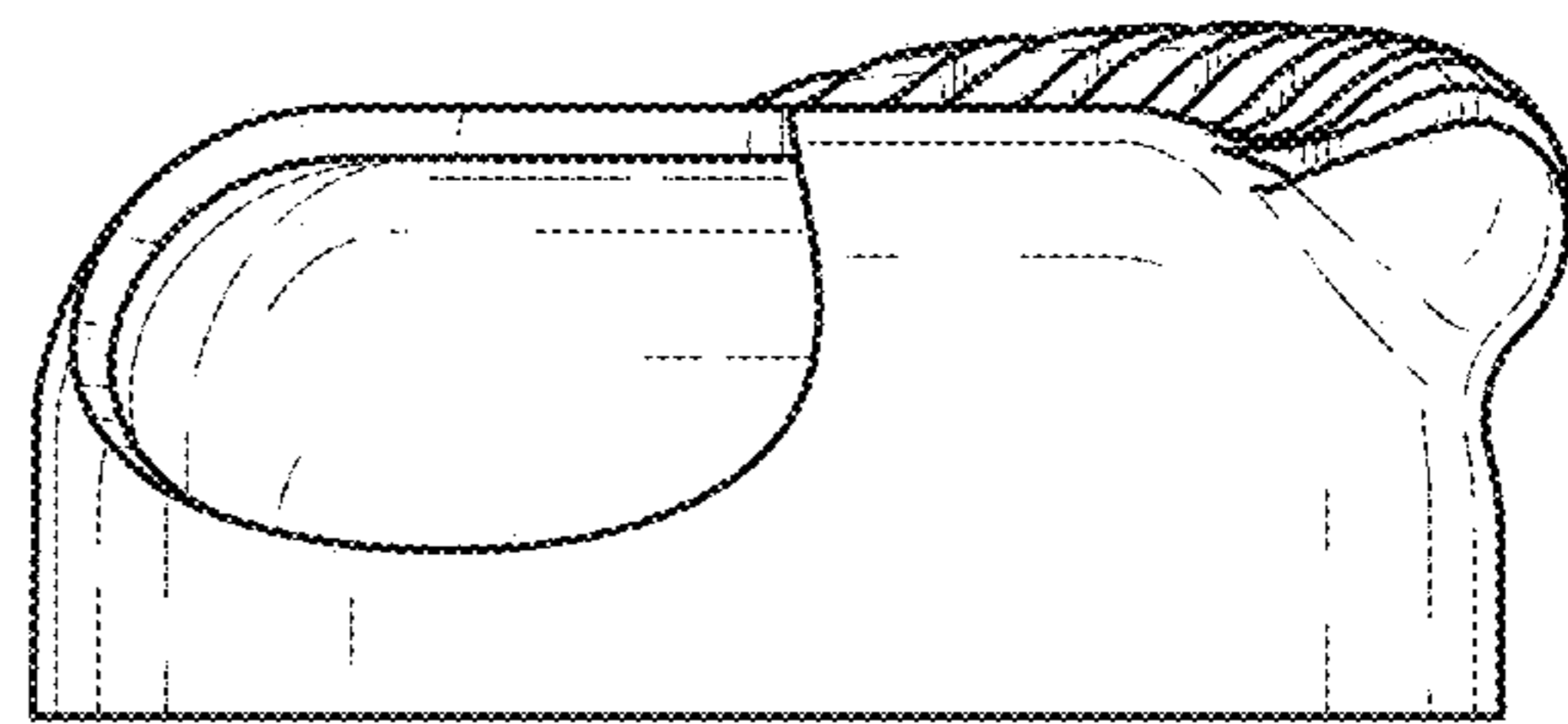

Fig. 7