



US00D872018S

(12) **United States Design Patent**
Dong

(10) **Patent No.:** **US D872,018 S**

(45) **Date of Patent:** **** Jan. 7, 2020**

(54) **POWER SUPPLY**

(71) Applicant: **Zhengchao Dong**, Guangdong (CN)

(72) Inventor: **Zhengchao Dong**, Guangdong (CN)

(**) Term: **15 Years**

(21) Appl. No.: **29/628,403**

(22) Filed: **Dec. 5, 2017**

(51) **LOC (12) Cl.** **13-02**

(52) **U.S. Cl.**
USPC **D13/110; D13/116**

(58) **Field of Classification Search**
USPC D13/101, 102, 103, 107, 108, 109, 110,
D13/112, 113, 114, 116, 119, 122, 184,
D13/199

CPC H01M 10/44; H01M 10/46; H01M 10/425;
Y02B 10/12; Y02B 10/20; Y02B 10/24;
H02J 7/34; H02J 7/35; H02J 7/42; H02J
7/44; H02J 7/54; H02J 7/0003; Y02T
90/122; Y02T 90/128; Y02T 90/163;
F02B 63/04; F02B 63/048; F02B 75/16;
F02B 2063/046

See application file for complete search history.

(56) **References Cited**

U.S. PATENT DOCUMENTS

6,091,160 A * 7/2000 Kouchi F02B 63/04
290/1 A
D474,738 S * 5/2003 Ishii D13/110

D477,569 S * 7/2003 Iwatate D13/116
D486,446 S * 2/2004 Hriscu D13/110
D650,739 S * 12/2011 Cai D13/116
D668,608 S * 10/2012 Itoh D13/116
D694,704 S * 12/2013 Cottle D13/107
D712,823 S * 9/2014 Lin D13/102
D794,562 S * 8/2017 Markoski D13/112
2004/0004356 A1 * 1/2004 Akimoto F02B 63/04
290/1 B

* cited by examiner

Primary Examiner — Derrick E Holland

(57) **CLAIM**

The ornamental design for a power supply, as shown.

DESCRIPTION

FIG. 1 is a front elevational view of a power supply showing my new design;
FIG. 2 is a rear elevational view thereof;
FIG. 3 is a left side view thereof;
FIG. 4 is a right side view thereof;
FIG. 5 is a top plan view thereof;
FIG. 6 is a bottom plan view thereof;
FIG. 7 is a perspective view thereof; and,
FIG. 8 is another perspective view thereof.

1 Claim, 7 Drawing Sheets

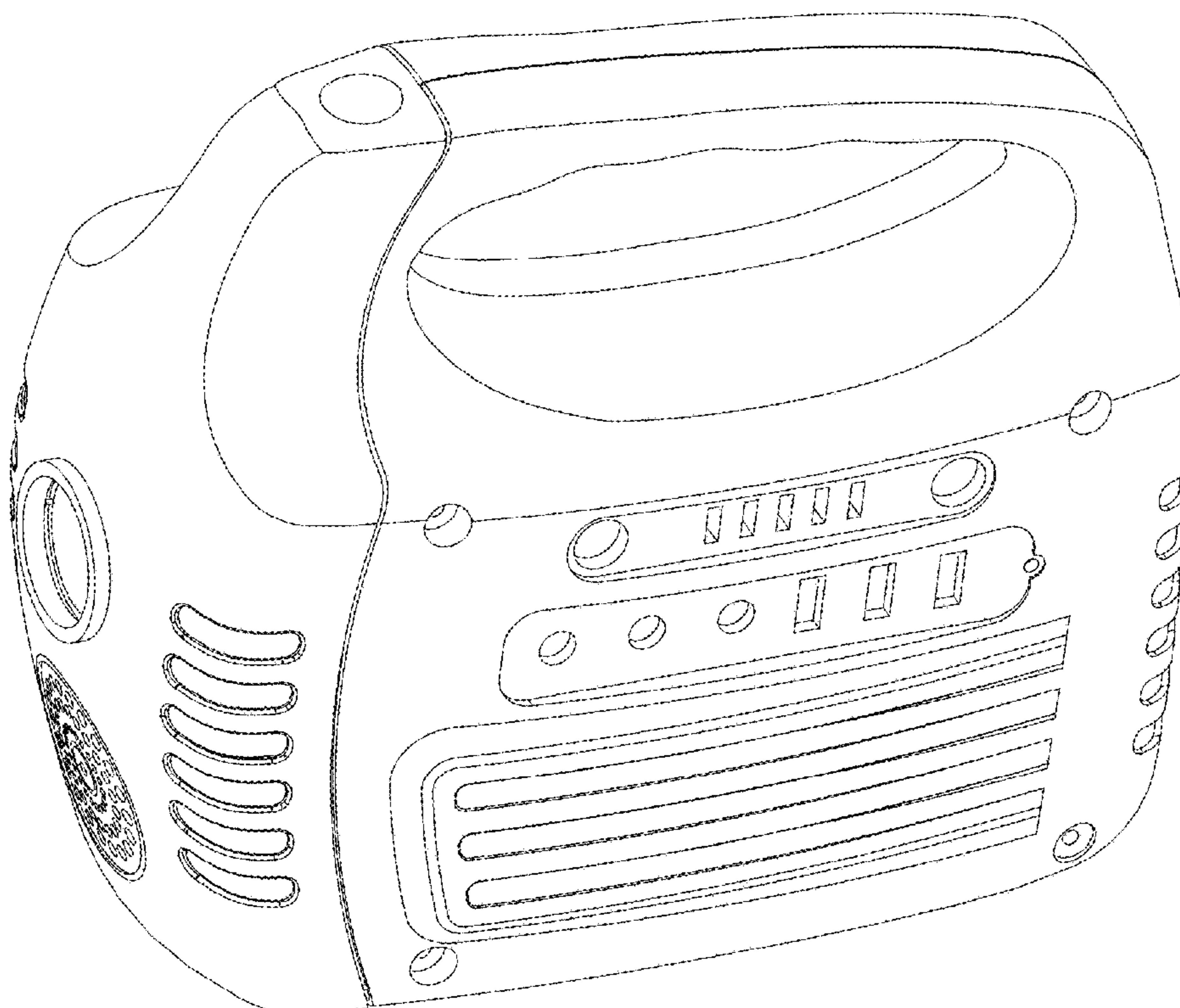

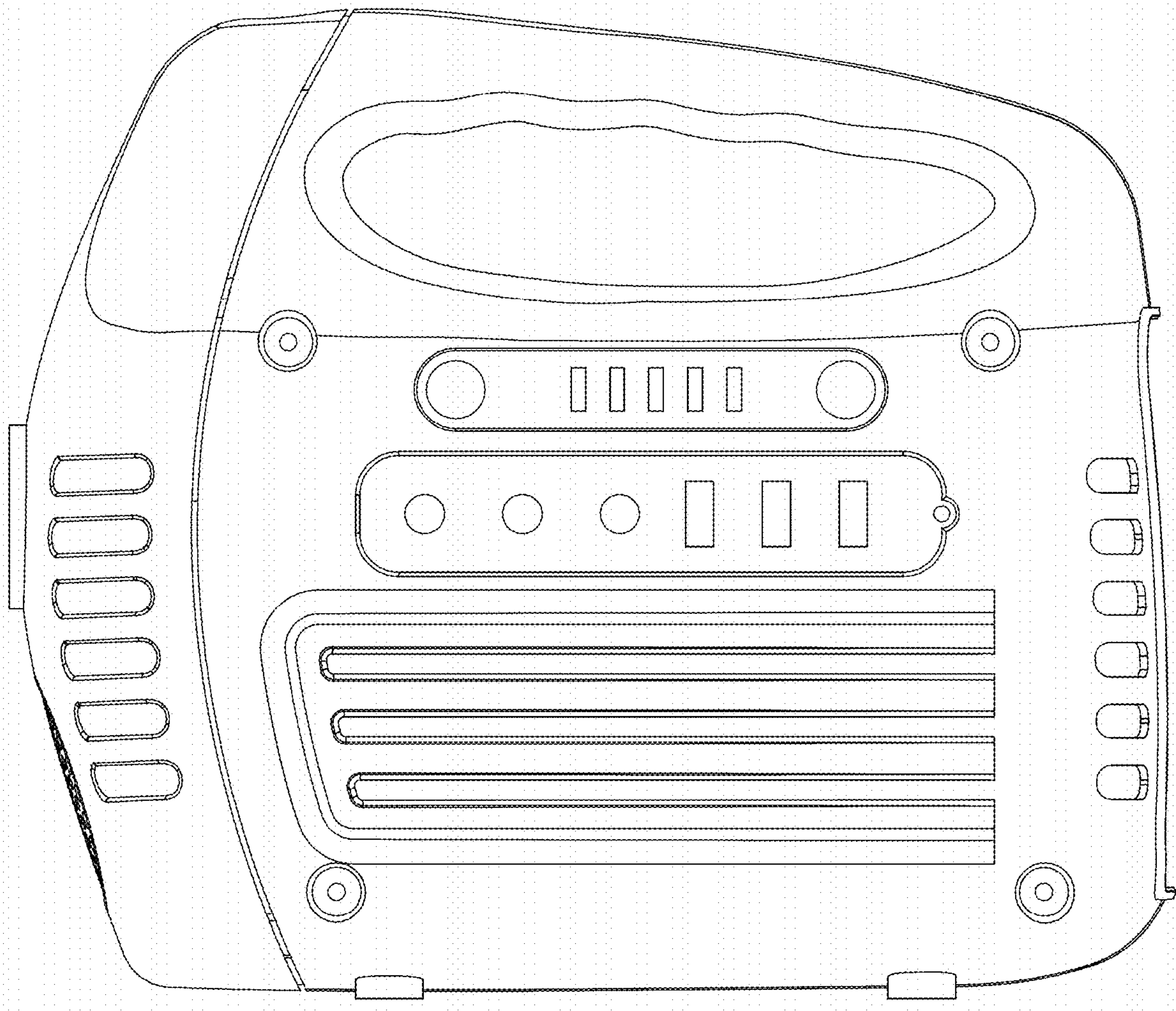

FIG. 1

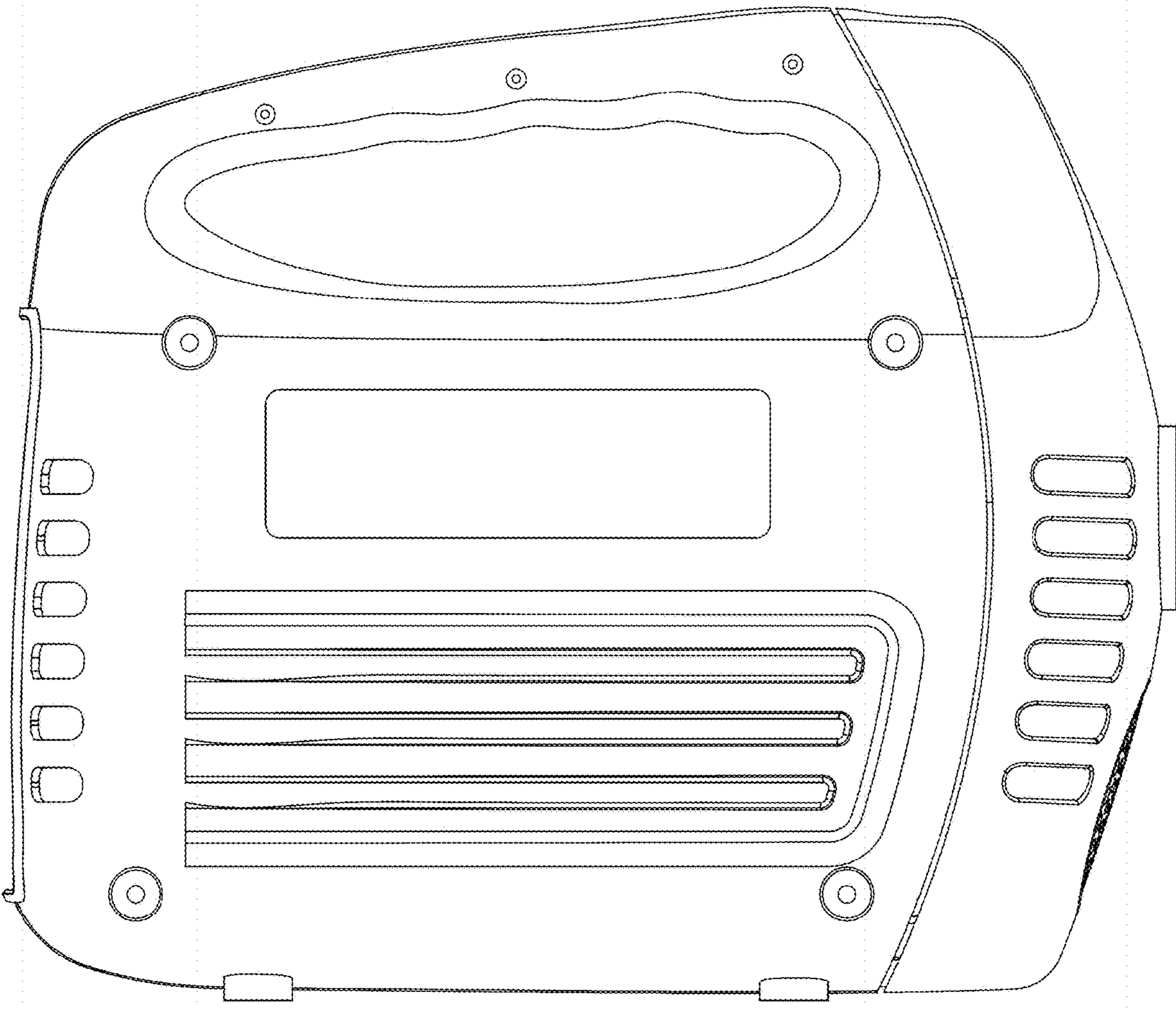

FIG. 2

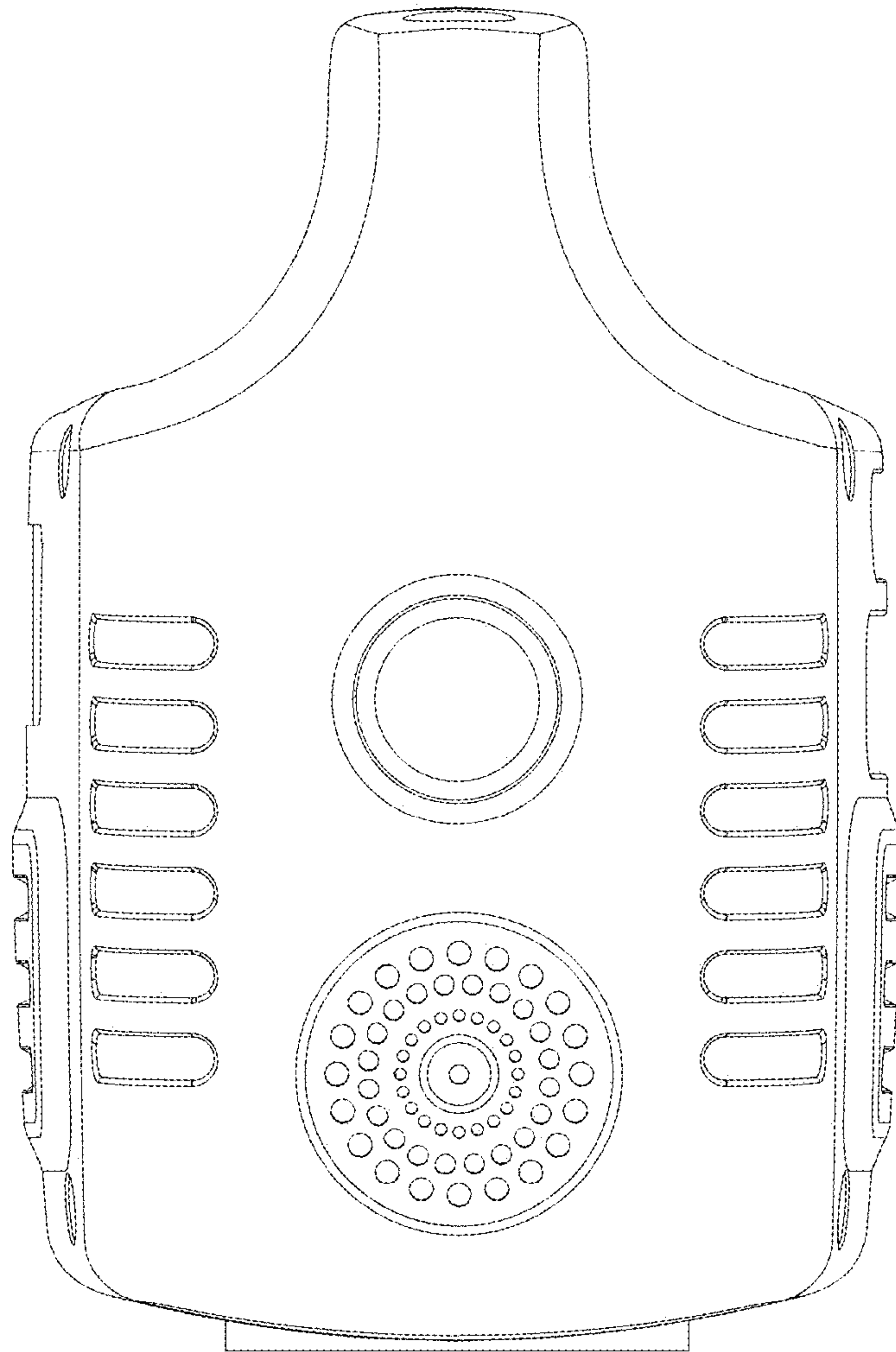

FIG. 3

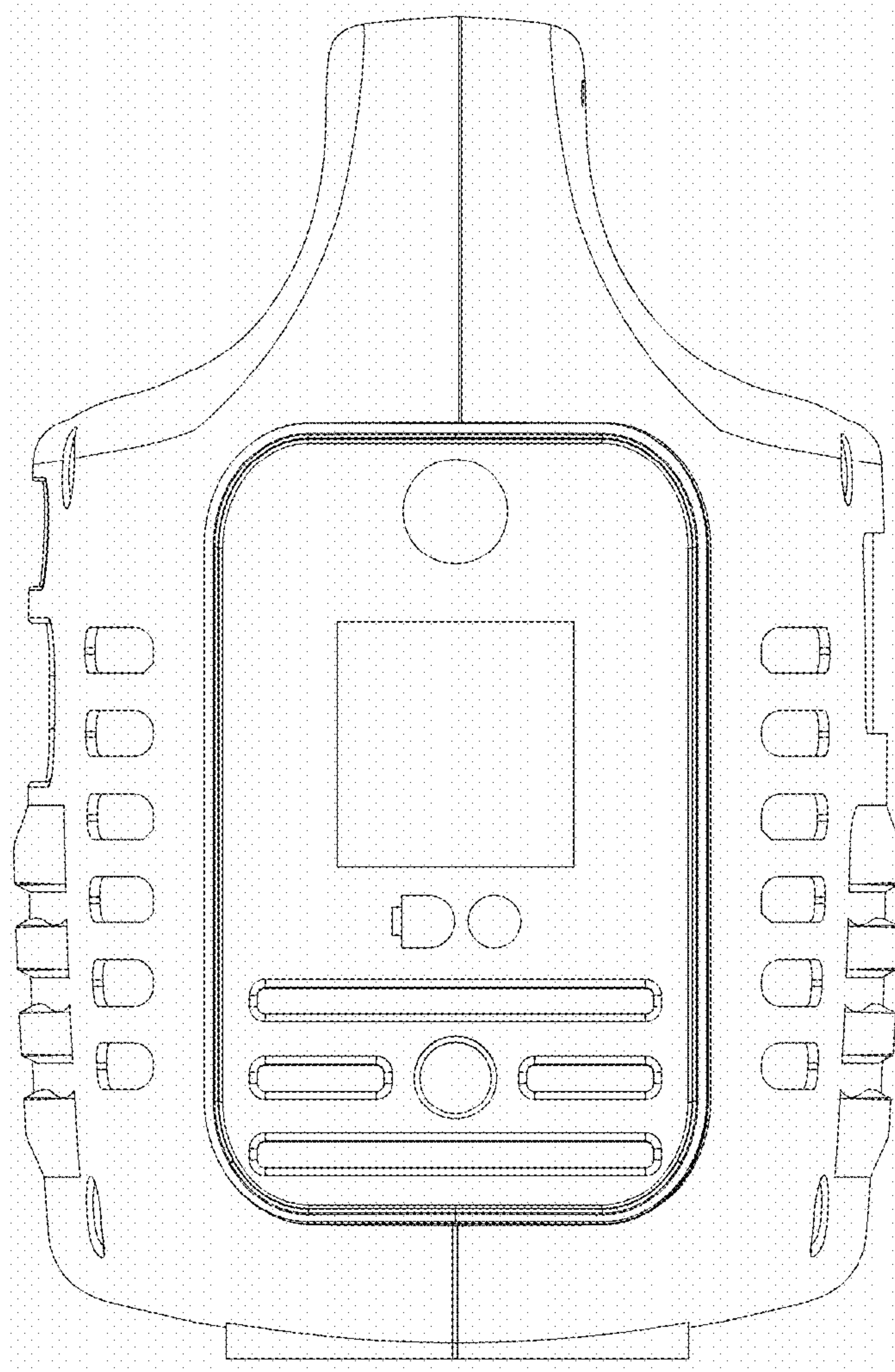

FIG. 4

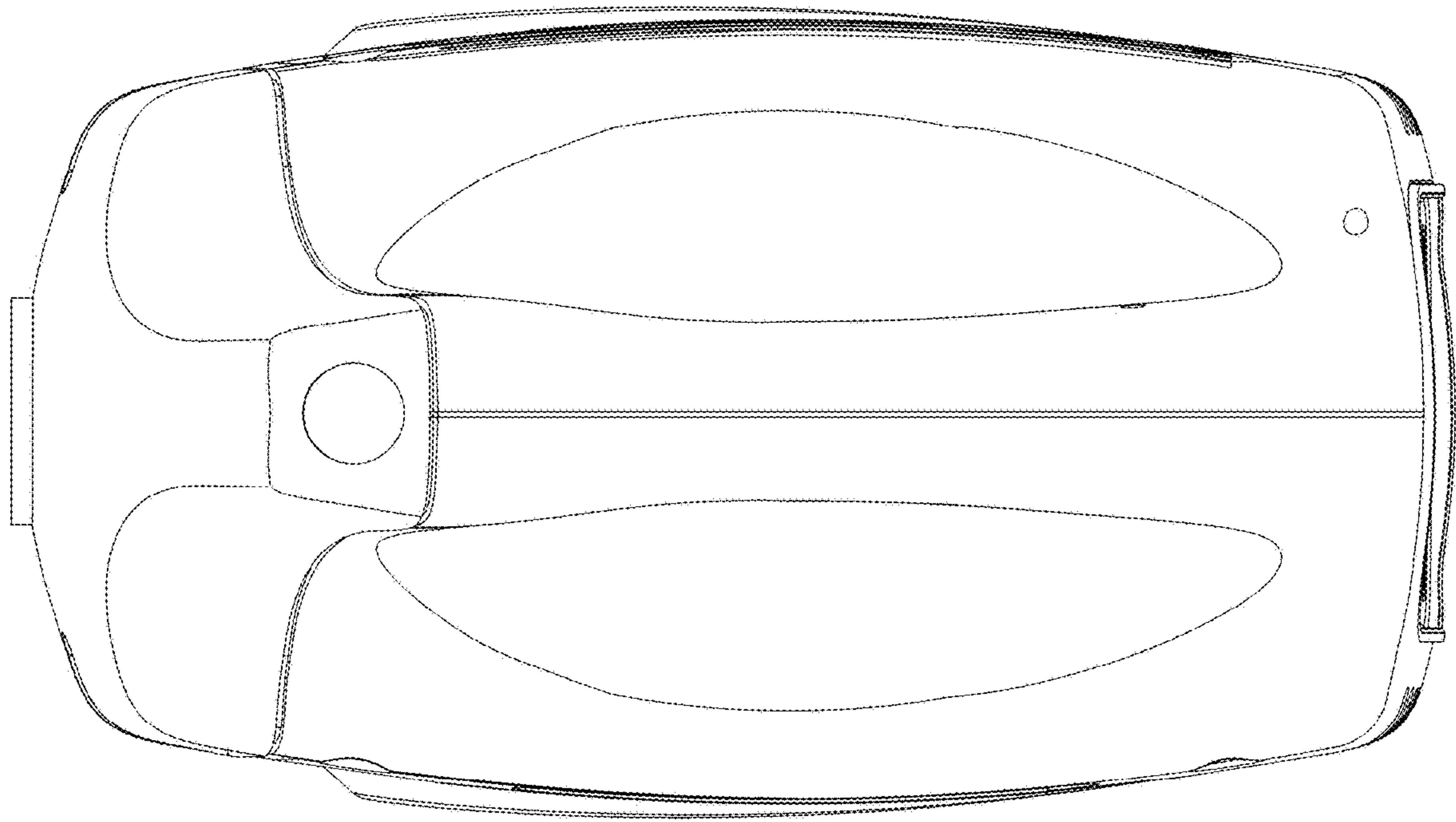

FIG. 5

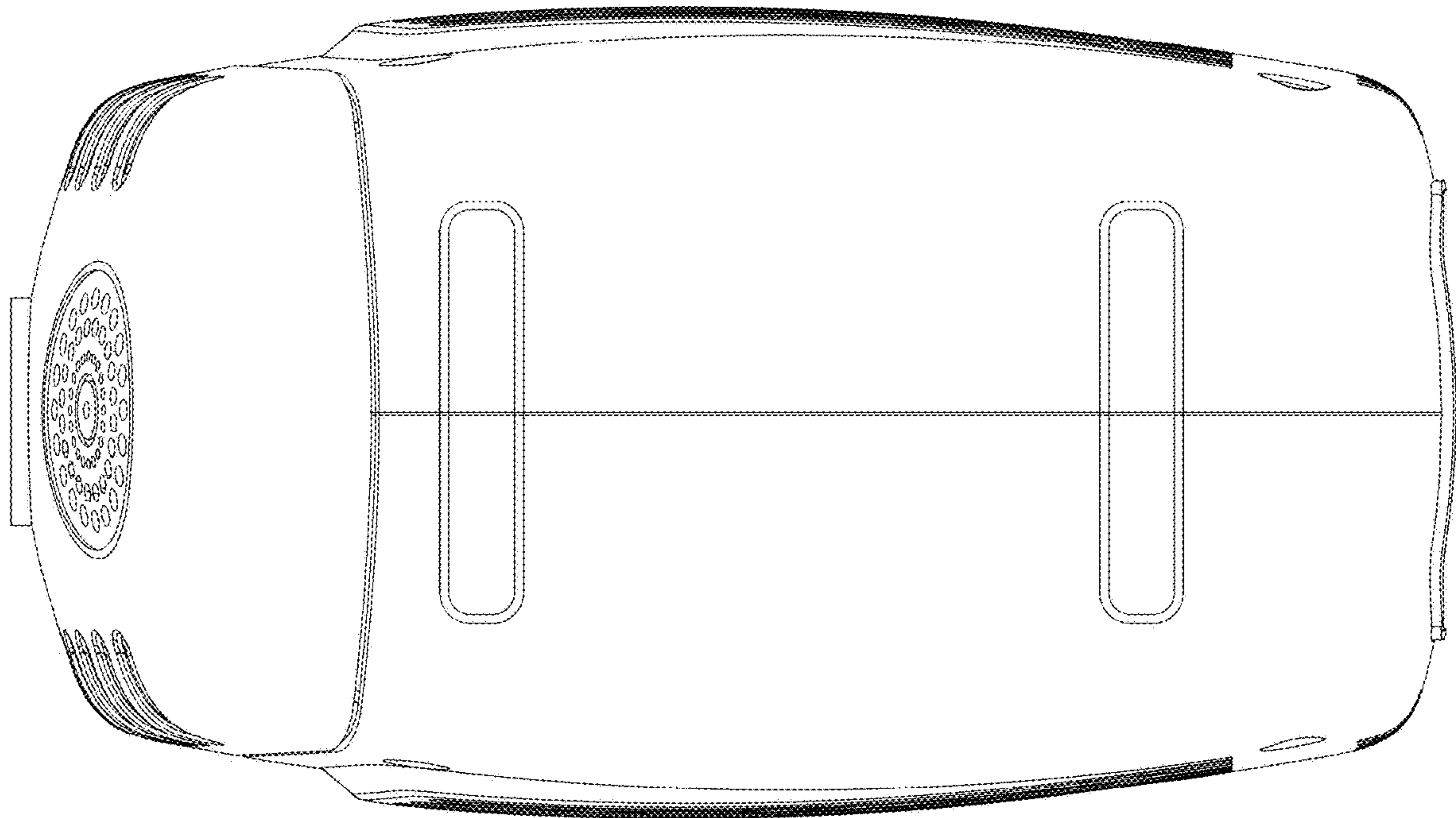

FIG. 6

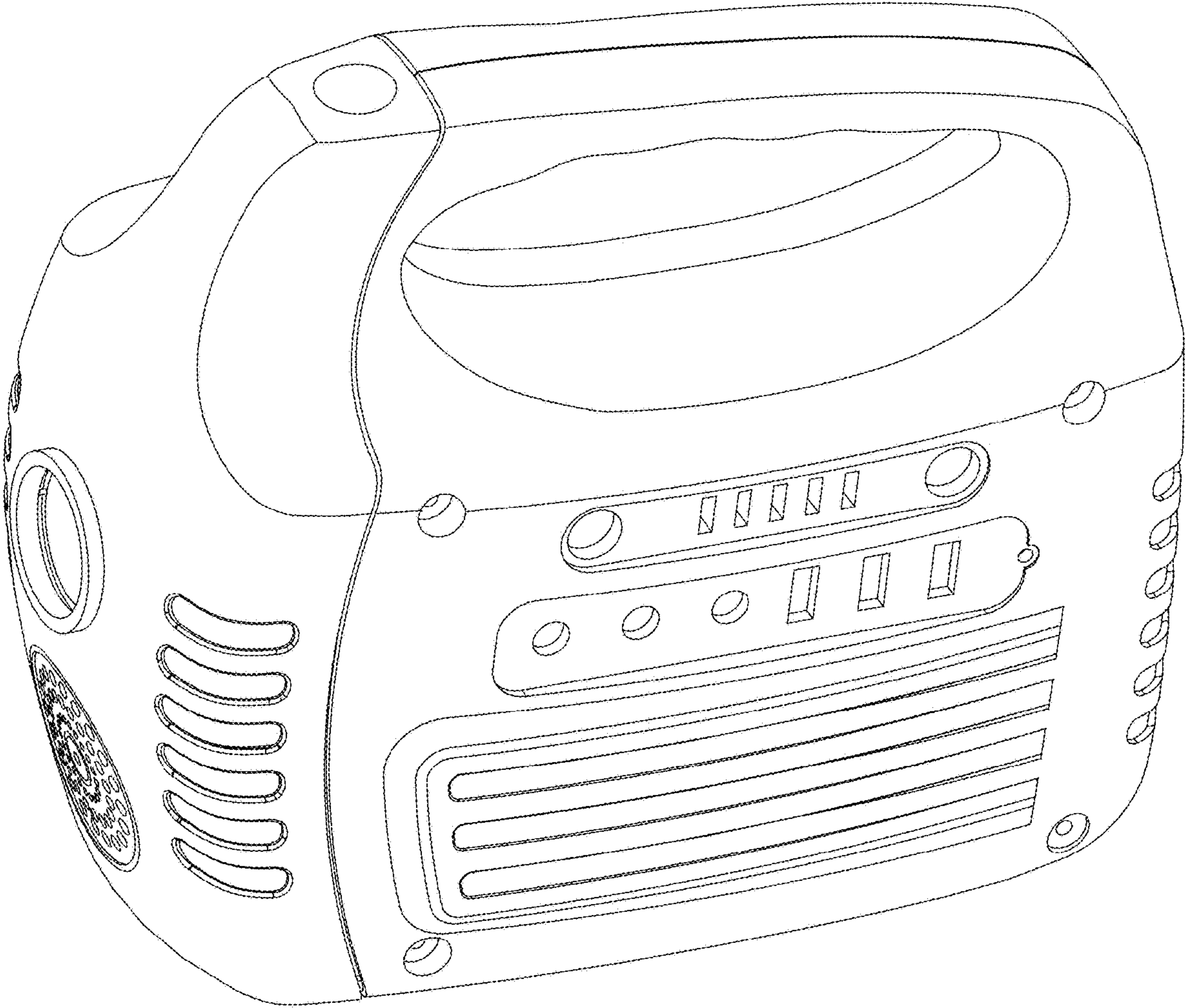

FIG. 7

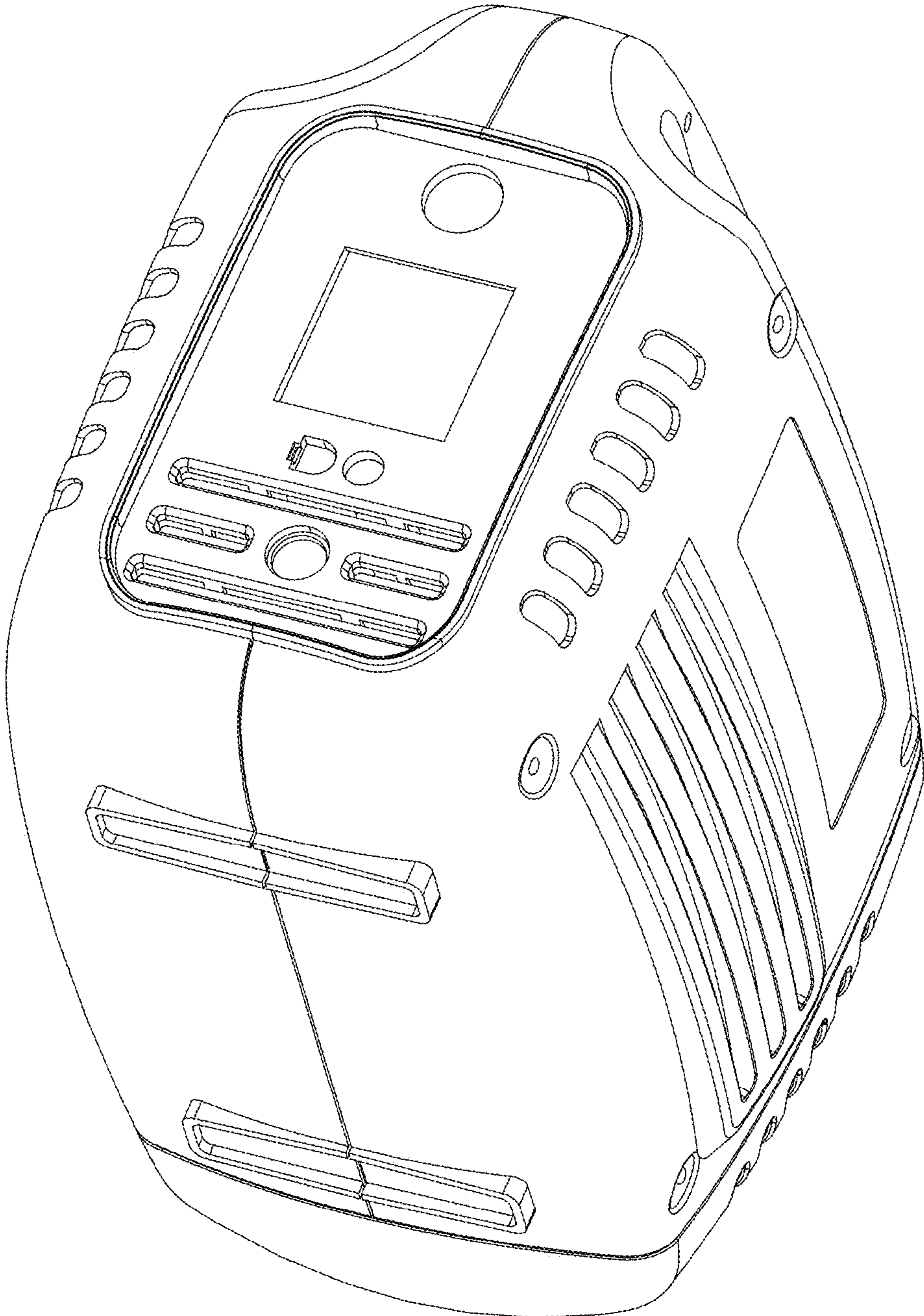

FIG. 8