



US00D872001S

(12) **United States Design Patent**
Keen

(10) **Patent No.:** **US D872,001 S**

(45) **Date of Patent:** **** Jan. 7, 2020**

(54) **EXTRUSION**

(71) Applicant: **Aluminium Industries Investments Pty Ltd**, Dandenong South (AU)

(72) Inventor: **Matthew William Keen**, Narre Warren South (AU)

(73) Assignee: **Aluminium Industries Investments Pty Ltd**, Dandenong South (AU)

(**) Term: **15 Years**

(21) Appl. No.: **29/626,483**

(22) Filed: **Nov. 17, 2017**

(30) **Foreign Application Priority Data**

May 17, 2017 (AU) 201712994

(51) **LOC (12) Cl.** **12-16**

(52) **U.S. Cl.**
USPC **D12/221**

(58) **Field of Classification Search**
USPC D12/221, 98; D9/431-433, 44, 420, 422, D9/423, 424
CPC .. B60R 99/00; B60R 5/00; B60R 7/04; B60N 2/30
See application file for complete search history.

(56) **References Cited**

U.S. PATENT DOCUMENTS

4,793,115 A * 12/1988 Horgan, Jr. E06B 3/305
29/446
D652,778 S * 1/2012 Segura D12/221

D709,429 S * 7/2014 Noone D12/221
D735,110 S * 7/2015 Wagner D12/221
D738,806 S * 9/2015 Williamson D12/221
D761,185 S * 7/2016 Coyle D12/221
D796,415 S * 9/2017 Tsukamoto D12/331
D820,188 S * 6/2018 Hanson D12/221
D849,661 S * 5/2019 Fukushima D12/221

* cited by examiner

Primary Examiner — Katrina A Betton

(74) *Attorney, Agent, or Firm* — Richard A. Fagin

(57) **CLAIM**

I claim the ornamental design for an extrusion, as shown and described.

DESCRIPTION

FIG. 1 is an above front perspective view of an extrusion showing my new design;
FIG. 2 is a below rear perspective view thereof;
FIG. 3 is a front view thereof;
FIG. 4 is a rear view thereof;
FIG. 5 is a left view thereof;
FIG. 6 is a right view thereof;
FIG. 7 is a top view thereof; and,
FIG. 8 is an underneath view thereof.
The double broken lines in the various figures indicate that the design is of indefinite length and do not form part of the claimed design.

1 Claim, 6 Drawing Sheets

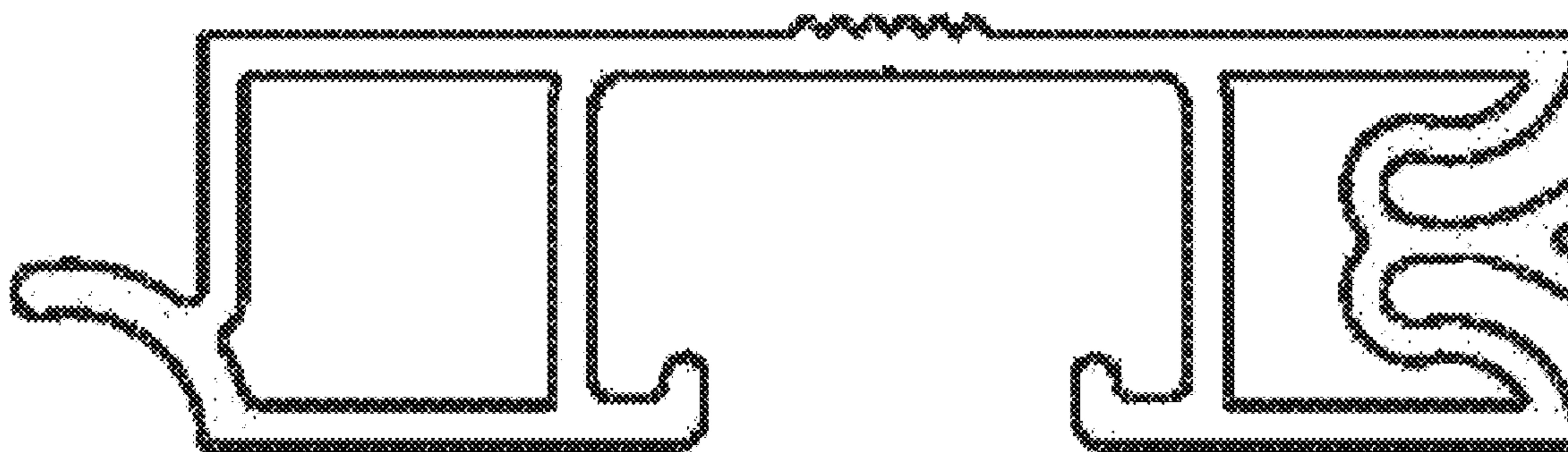

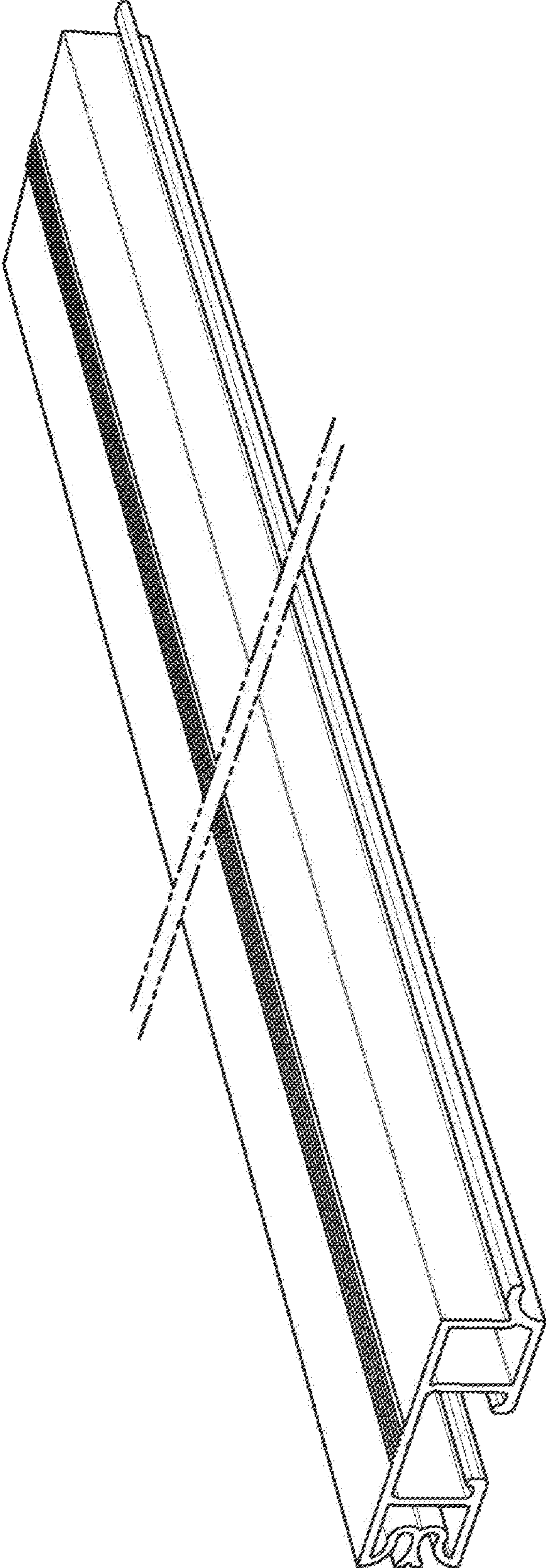

FIG. 1

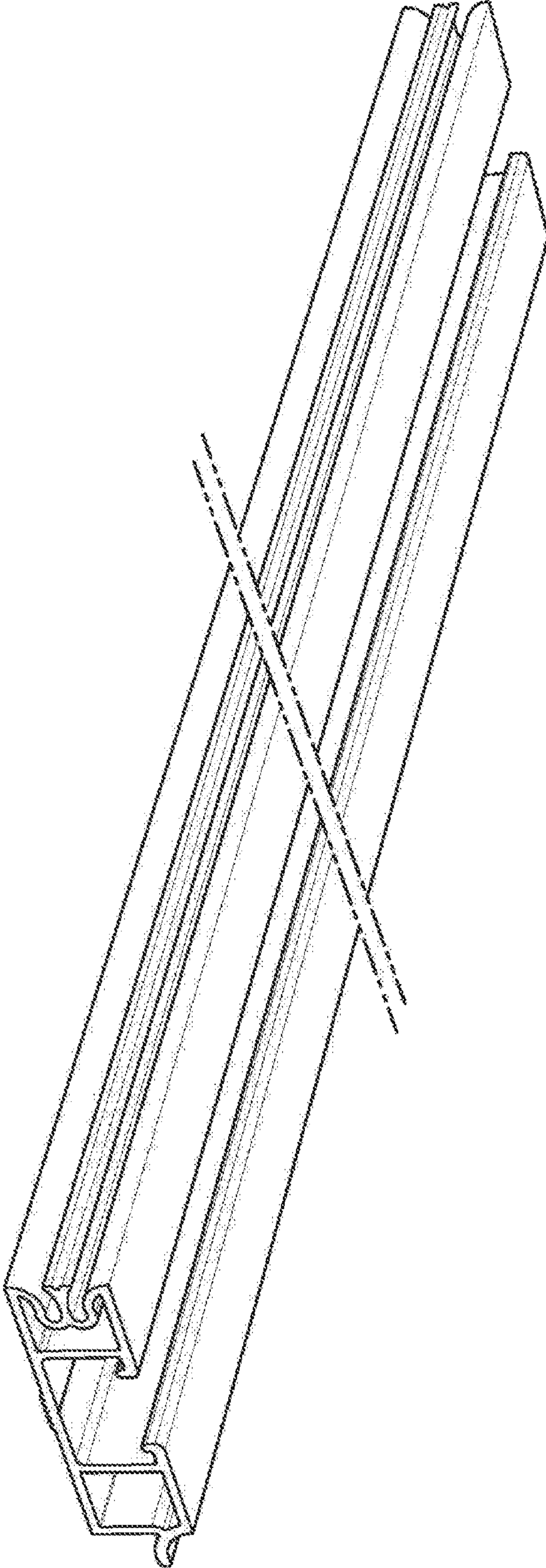

FIG. 2

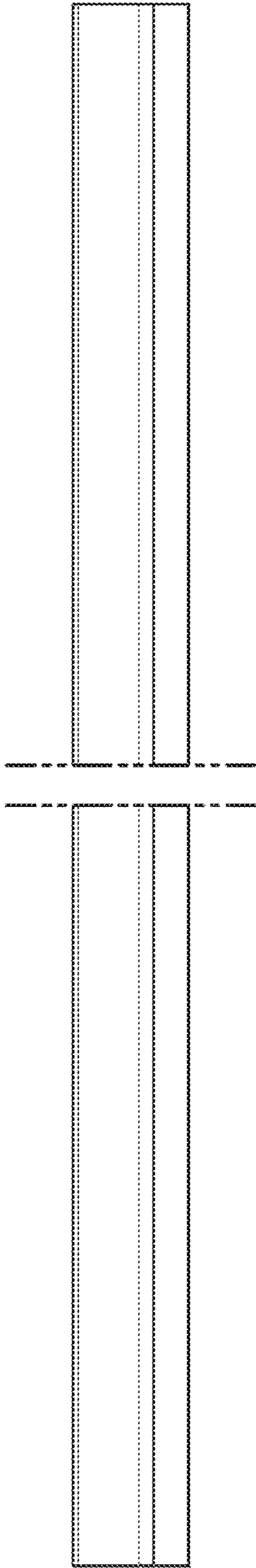

FIG. 3

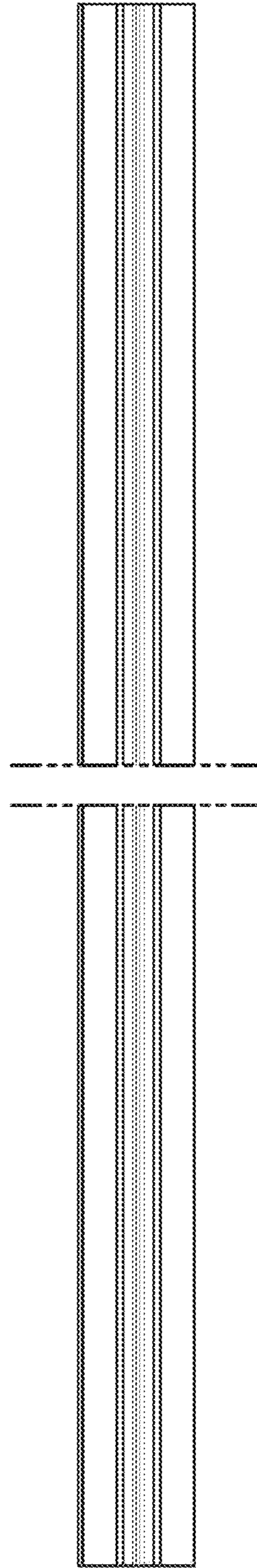

FIG. 4

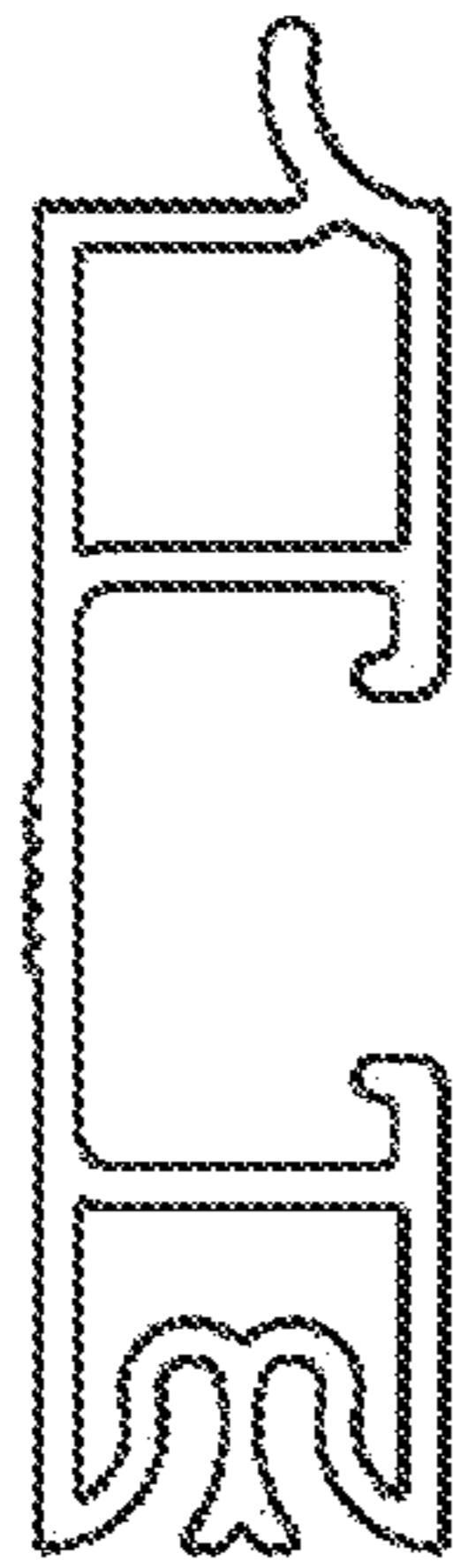

FIG. 5

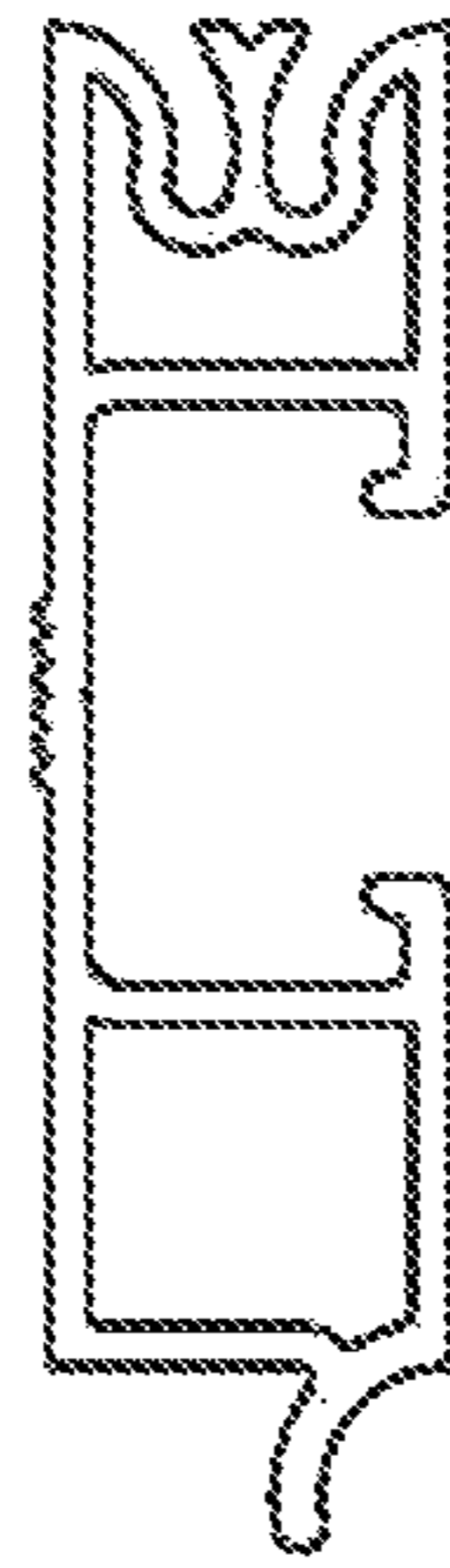

FIG. 6

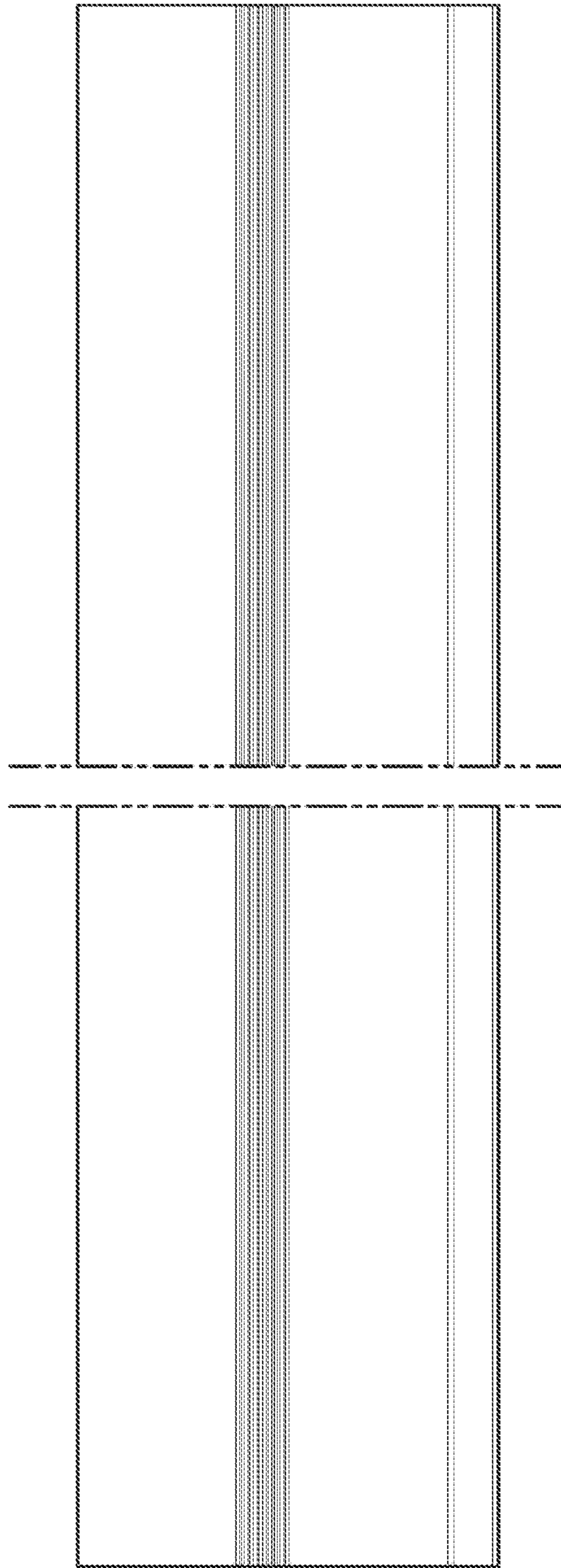

FIG. 7

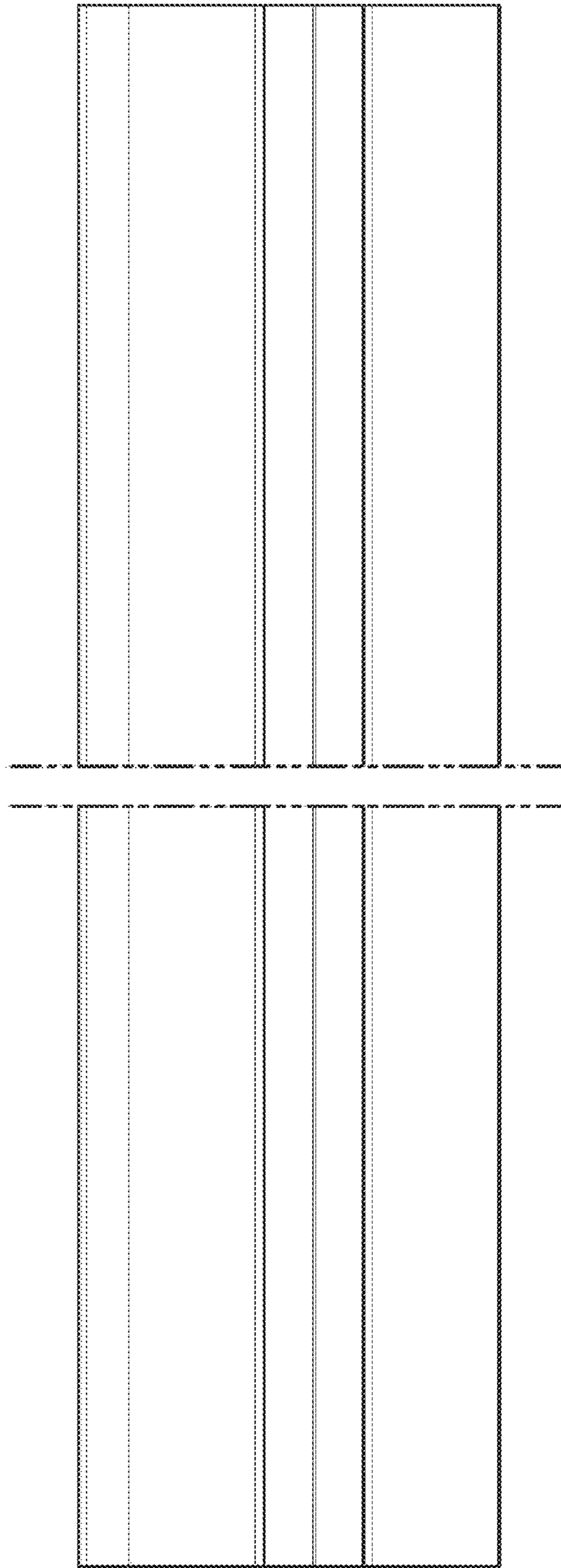

FIG. 8