

US00D871902S

(12) **United States Design Patent**
Shenfarber

(10) **Patent No.:** **US D871,902 S**
(45) **Date of Patent:** **** Jan. 7, 2020**

(54) **PACKAGING BOX HAVING A TOP AND BOTTOM PORTION AND A FRONT COVER FLAP**

(71) Applicant: **OMM Imports, Inc.**, Doral, FL (US)

(72) Inventor: **Moti Shenfarber**, Miami, FL (US)

(**) Term: **15 Years**

(21) Appl. No.: **29/665,452**

(22) Filed: **Oct. 3, 2018**

(51) **LOC (12) Cl.** **09-03**

(52) **U.S. Cl.**
USPC **D9/432**

(58) **Field of Classification Search**

USPC D9/414-423, 424-429, 430-433, 434, D9/456, 457, 711, 713, 721-722, 732, D9/737, 759; D3/272-274, 290, 304, D3/305, 310, 311, 312, 313, 314, 315, D3/319; D20/10, 22, 27, 40, 42
CPC ... B65D 5/00; B65D 5/02; B65D 5/18; B65D 5/20

See application file for complete search history.

(56) **References Cited**

U.S. PATENT DOCUMENTS

4,553,666 A * 11/1985 Gullikson B65D 5/5445 229/112
D333,781 S * 3/1993 Kobel D30/124
D466,412 S * 12/2002 Baskinger D9/432
D528,794 S * 9/2006 Lanham D3/294
D531,043 S * 10/2006 Houtart D9/560

(Continued)

Primary Examiner — Vy N Koenig

(74) *Attorney, Agent, or Firm* — The Concept Law Group, PA; Scott D. Smiley; Scott M. Garrett

(57) **CLAIM**

The ornamental design for a packaging box having a top and bottom portion and a front cover flap, as shown and described.

DESCRIPTION

FIG. 1 is a front-elevational view of the packaging box having a top and bottom portion and a front cover flap with the front cover flap in a closed configuration; FIG. 2 is a right-side elevational view thereof; FIG. 3 is a left-side elevational view thereof; FIG. 4 is a rear-elevational view thereof; FIG. 5 is a bottom plan view thereof; FIG. 6 is top plan view thereof; and FIG. 7 is a perspective view thereof from the top front left; FIG. 8 is a front-elevational view of the packaging box having a top and bottom portion and a front cover flap with the front cover flap in an open configuration; FIG. 9 is a right-side elevational view thereof; FIG. 10 is a left-side elevational view thereof; FIG. 11 is a rear-elevational view thereof; FIG. 12 is a bottom plan view thereof; FIG. 13 is top plan view thereof; and FIG. 14 is a perspective view thereof from the top front left; FIG. 15 is a perspective view from the top left front of the packaging box having a top and bottom portion and a front cover flap with the front cover flap in an open configuration and the top separated from the bottom portion; FIG. 16 is a front elevational view of the bottom portion of the packaging box, shown separately for completeness of illustration; FIG. 17 is a right-side elevational view thereof; FIG. 18 is a left-side elevational view thereof; FIG. 19 is a rear-elevational view thereof; FIG. 20 is a bottom plan view thereof; and, FIG. 21 is top plan view thereof.

The broken lines showing the “X” at the front on the cover flap and on the inside front of the top portion depict environment only and form no part of the claimed design.

1 Claim, 21 Drawing Sheets

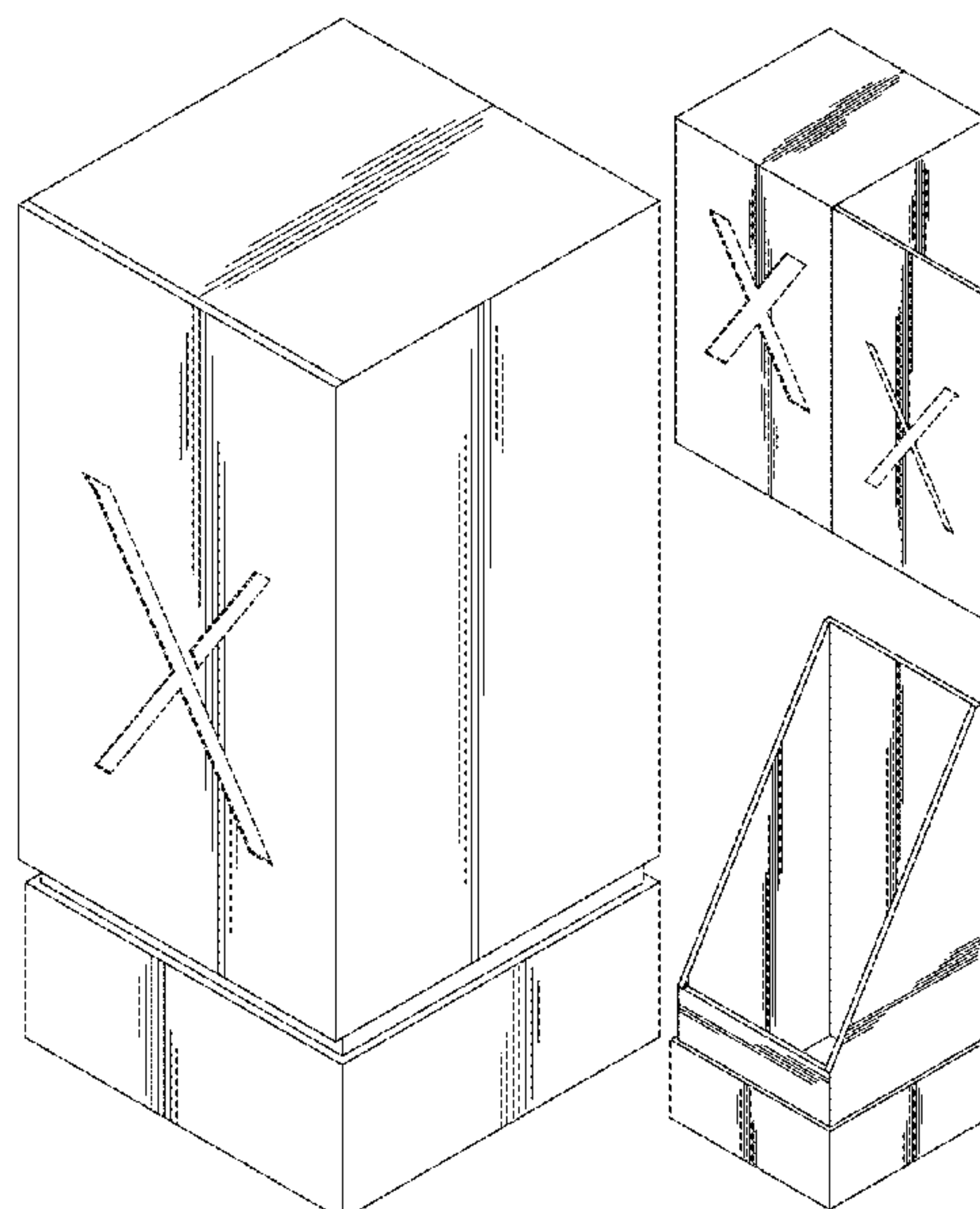

(56)

References Cited

U.S. PATENT DOCUMENTS

D548,592 S * 8/2007 Kudo D9/432
D595,129 S * 6/2009 Russell D9/432
D703,531 S * 4/2014 Gavrieli A43B 3/248
D9/432
D706,129 S * 6/2014 Boraczek D9/418
D721,577 S * 1/2015 Scatterday D9/432
D724,942 S * 3/2015 Mattila D9/432
D778,149 S * 2/2017 Frick D9/416
D837,062 S * 1/2019 Senior D9/667
D838,165 S * 1/2019 Handstein D9/432
D845,759 S * 4/2019 Arzano D9/432
D848,862 S * 5/2019 O'Neill D9/737

* cited by examiner

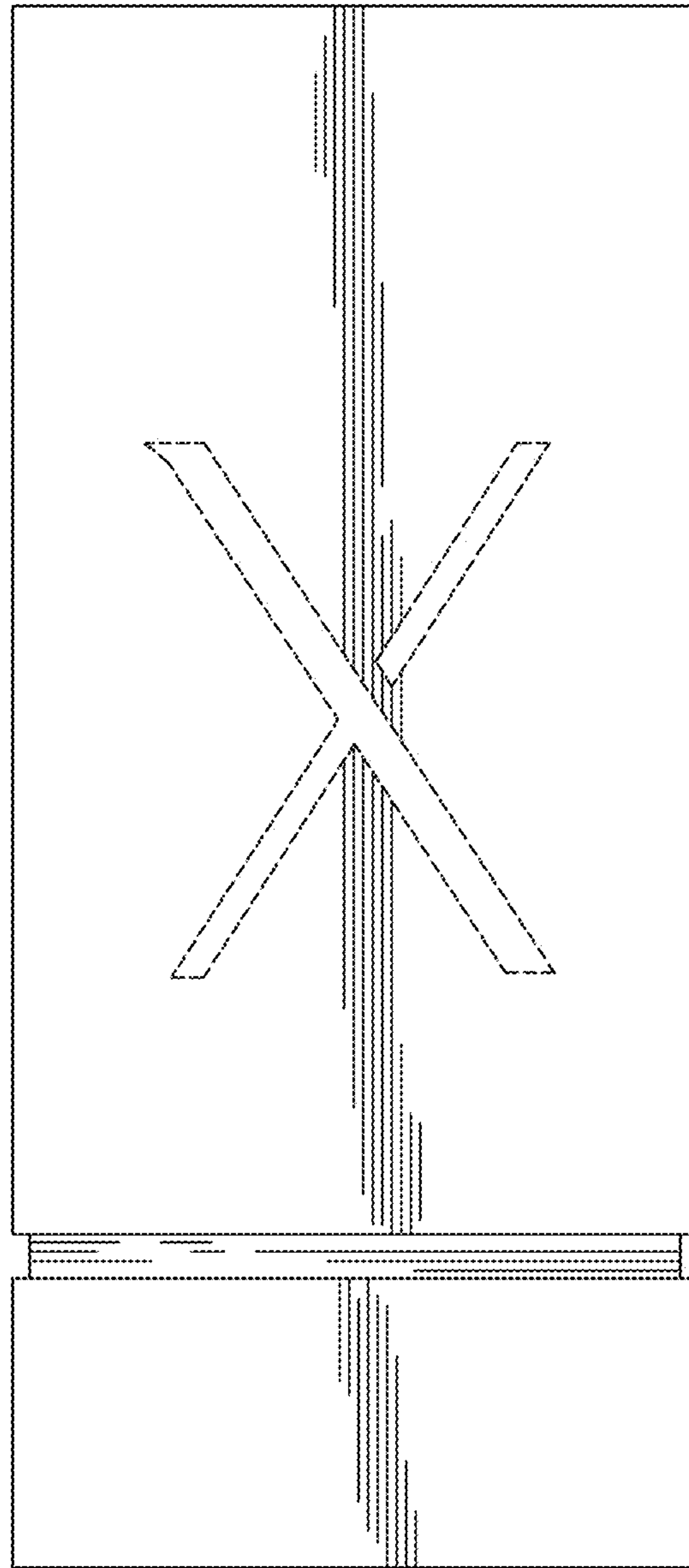

FIG.1

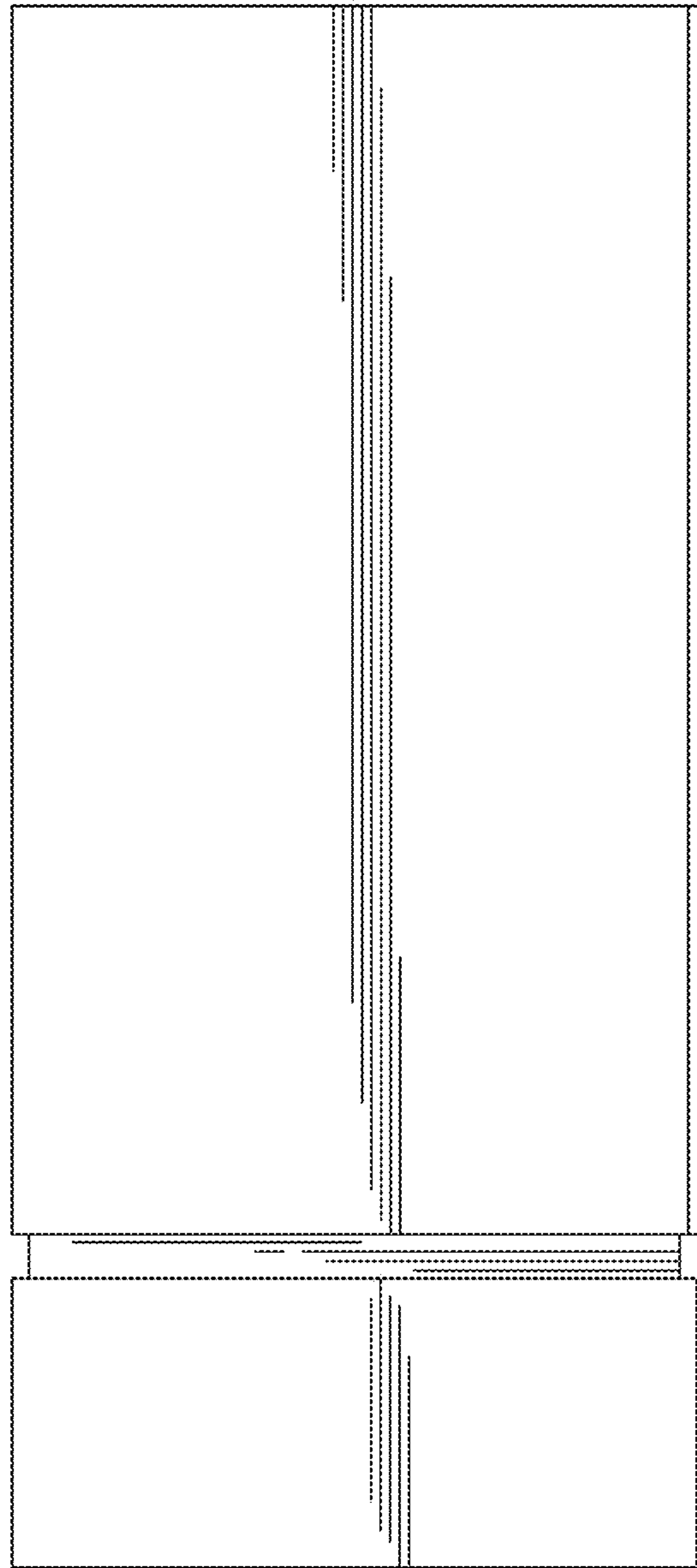

FIG.2

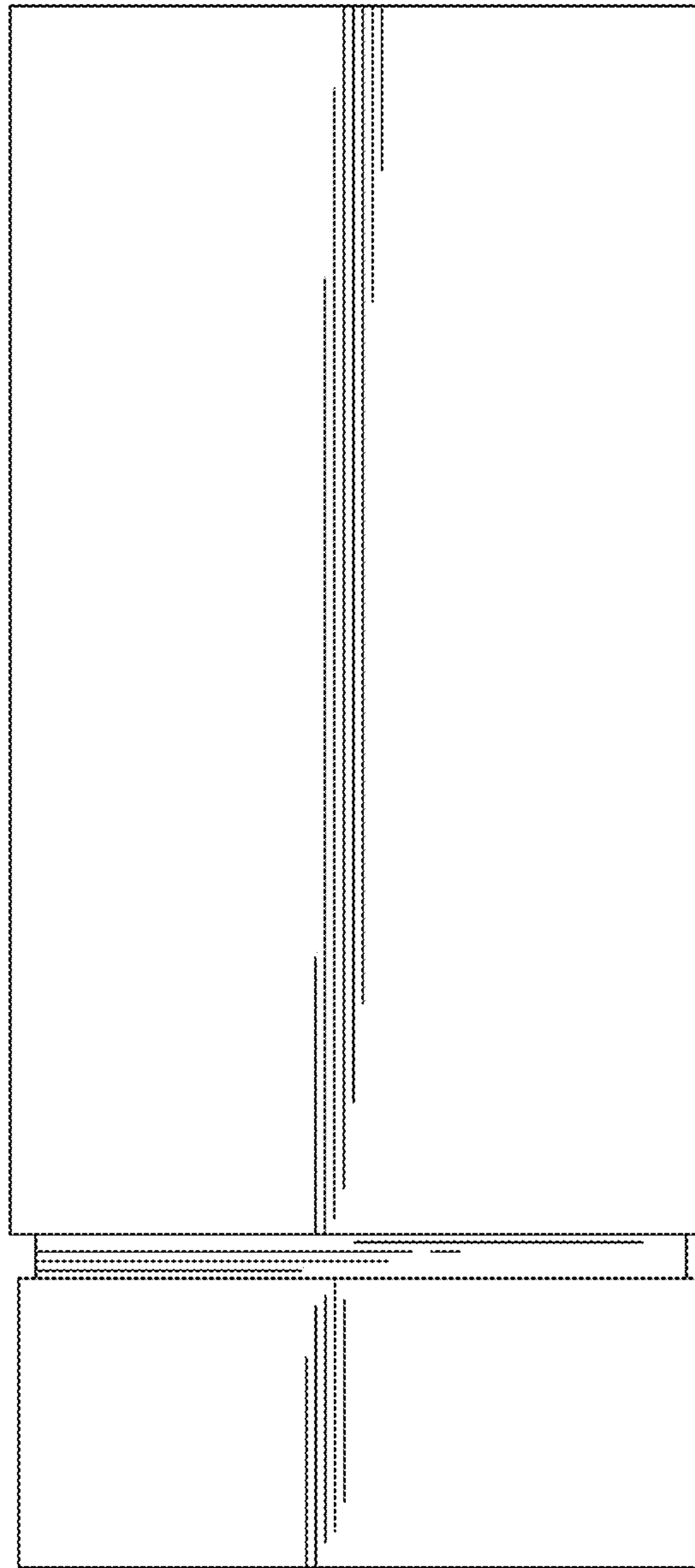

FIG.3

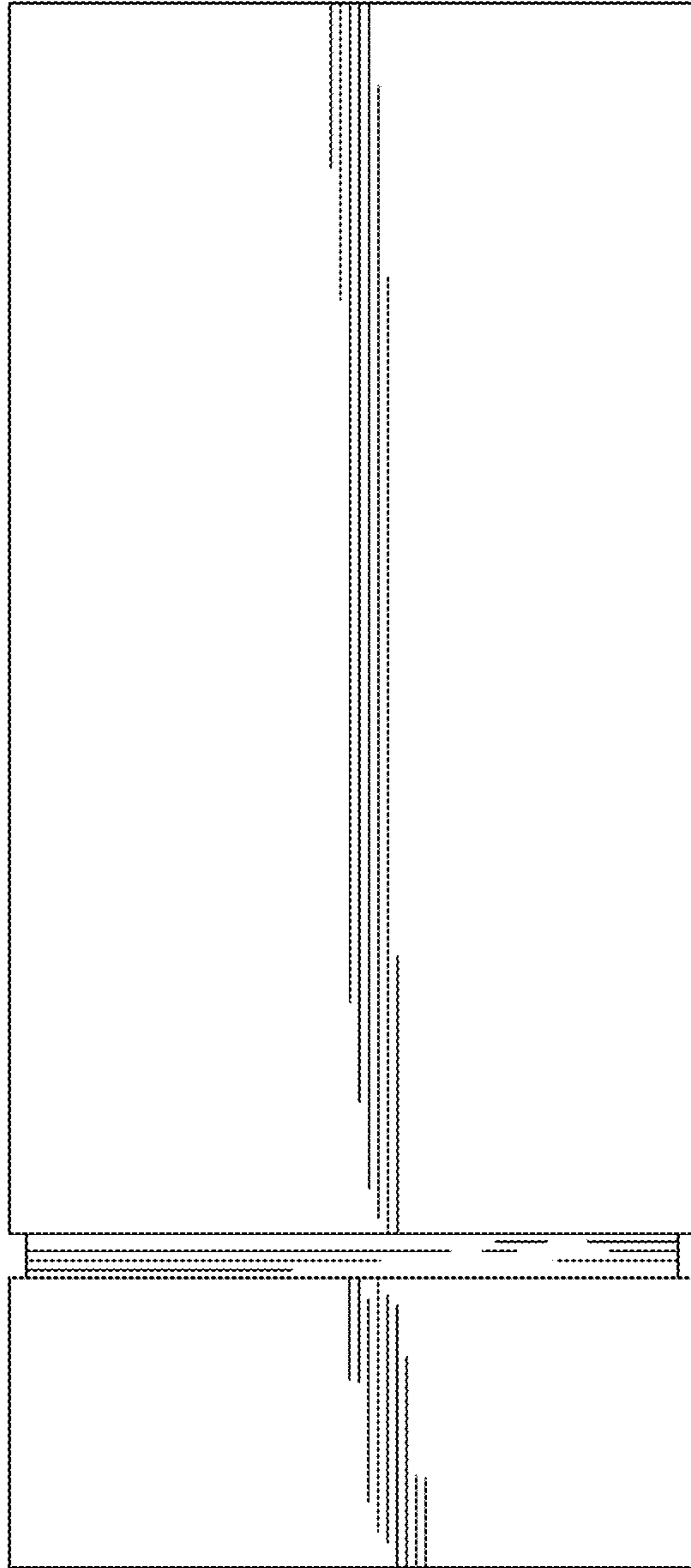

FIG.4

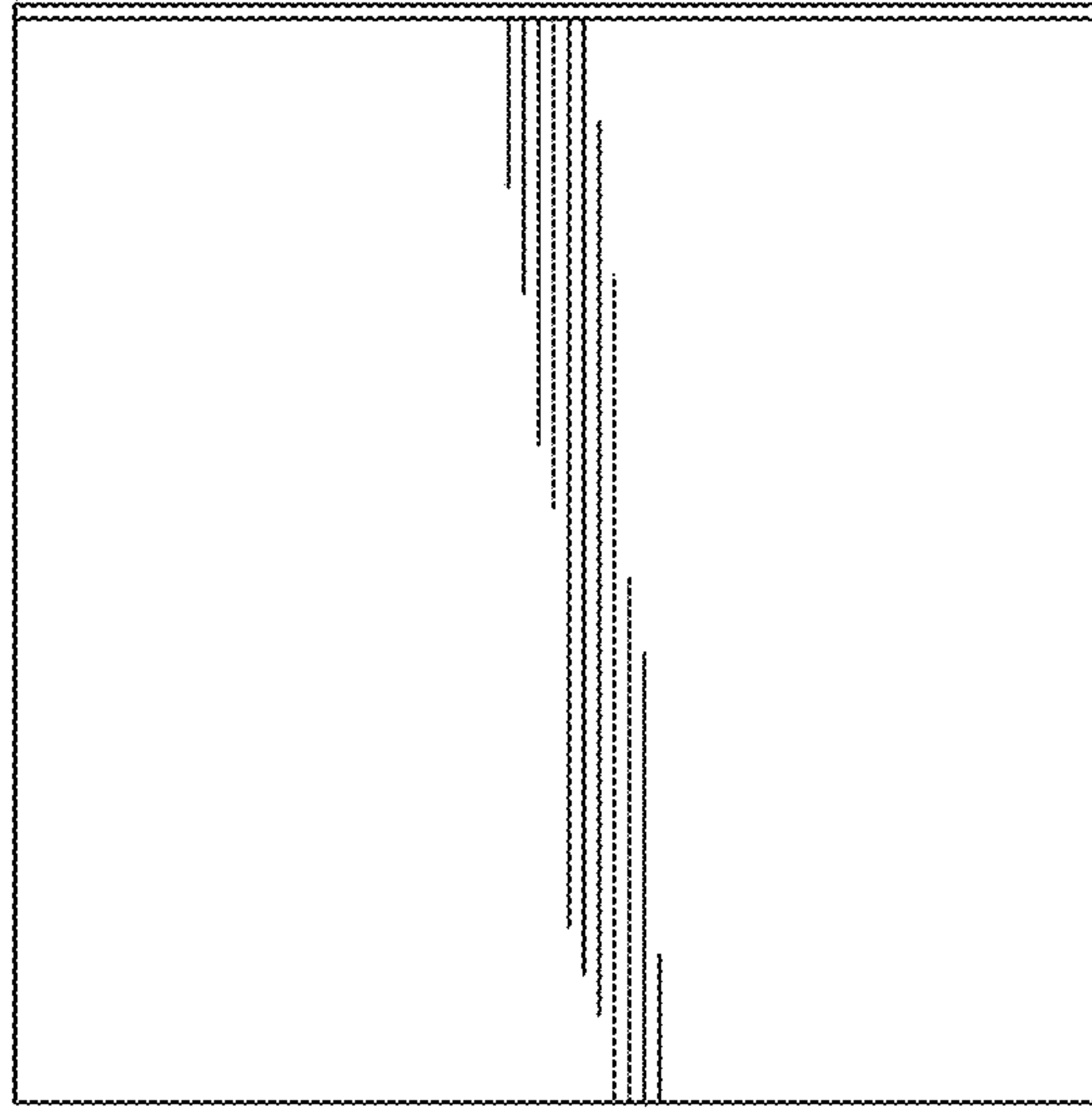

FIG.5

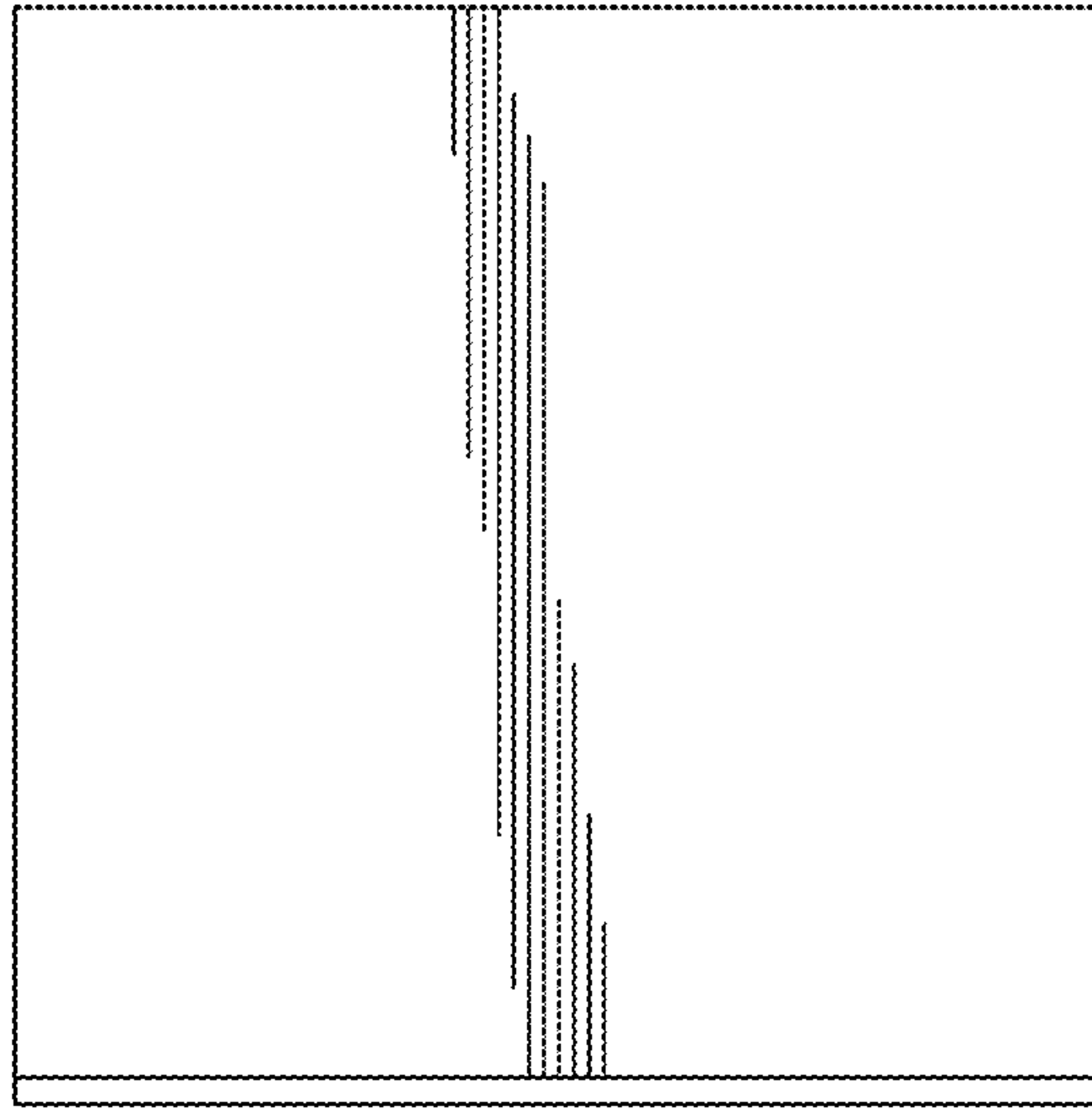

FIG.6

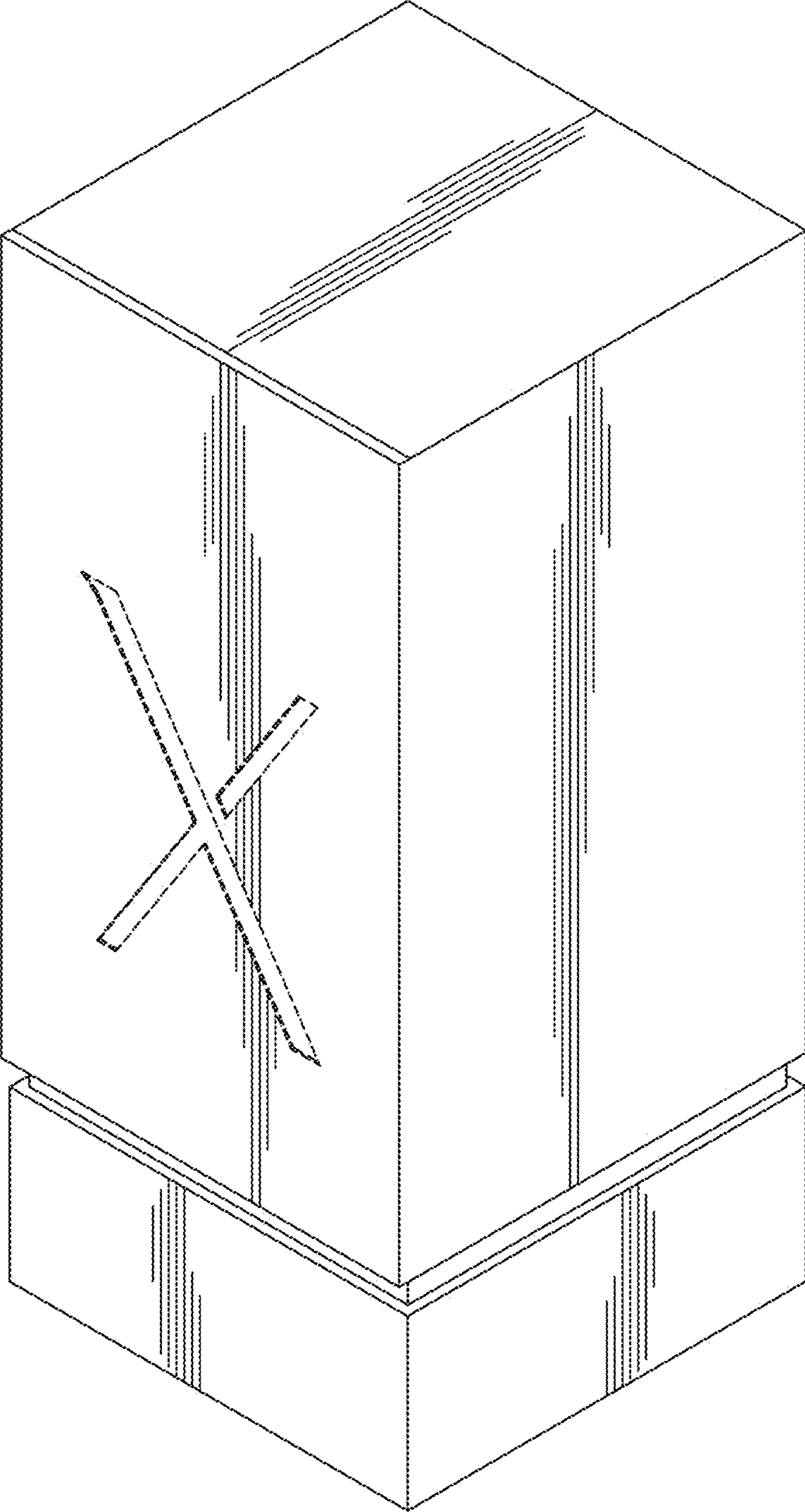

FIG. 7

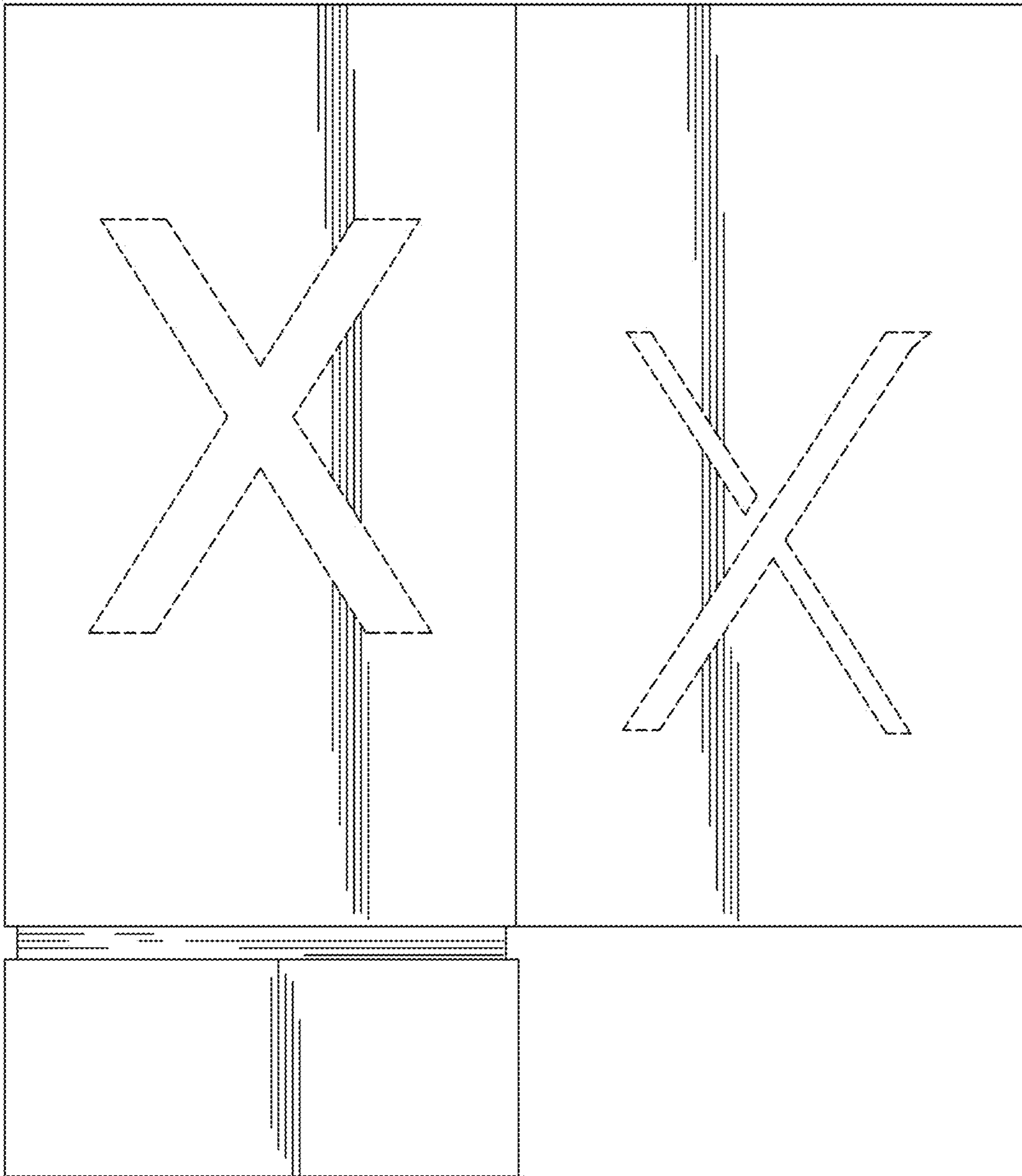

FIG. 8

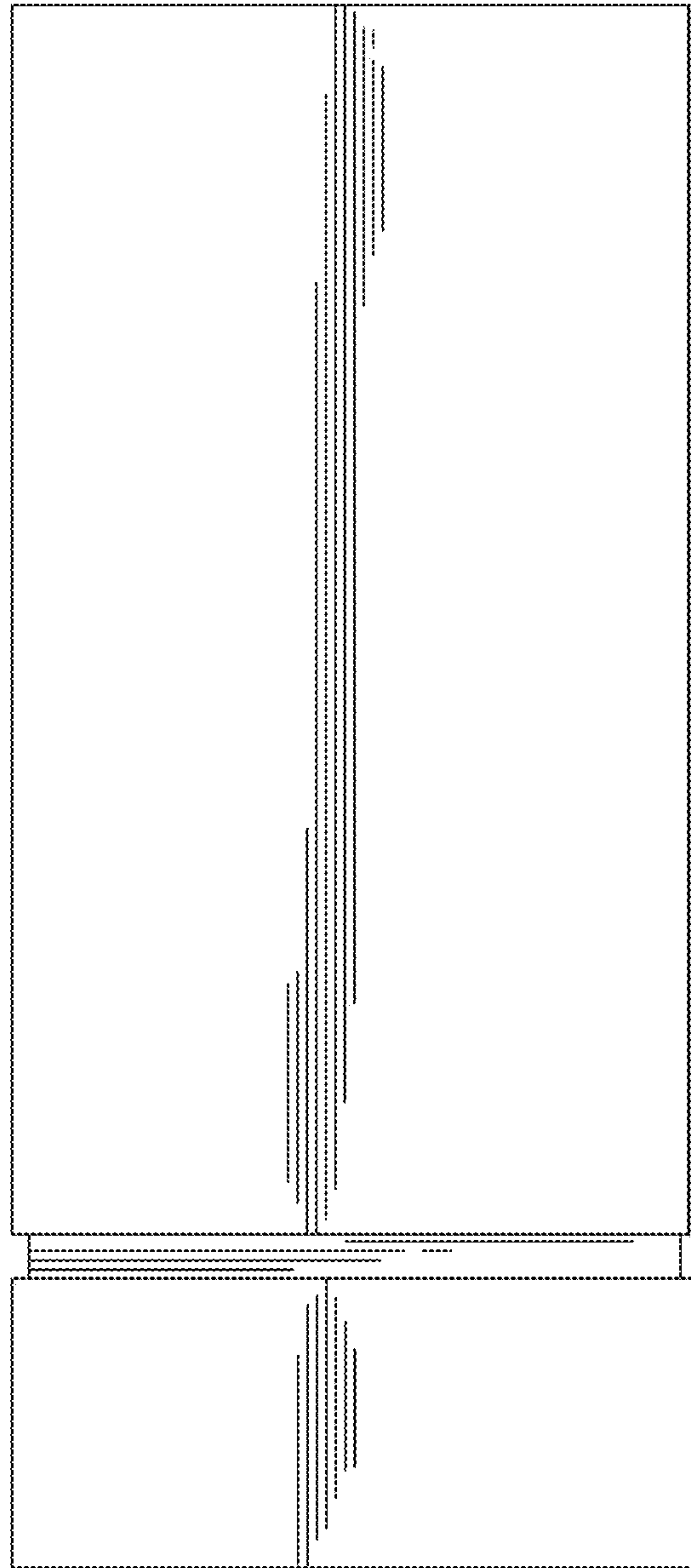

FIG. 9



FIG. 10

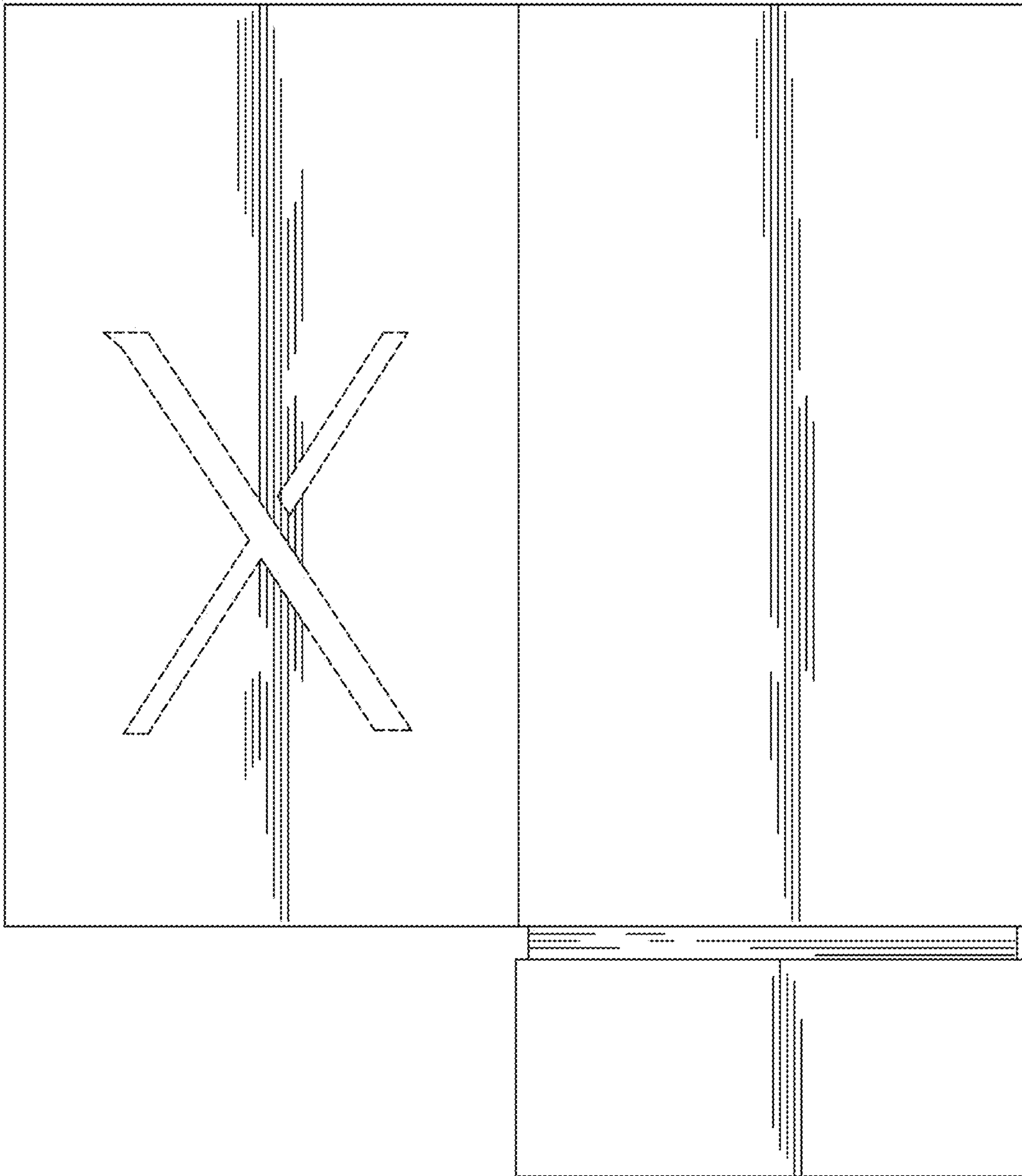

FIG.11

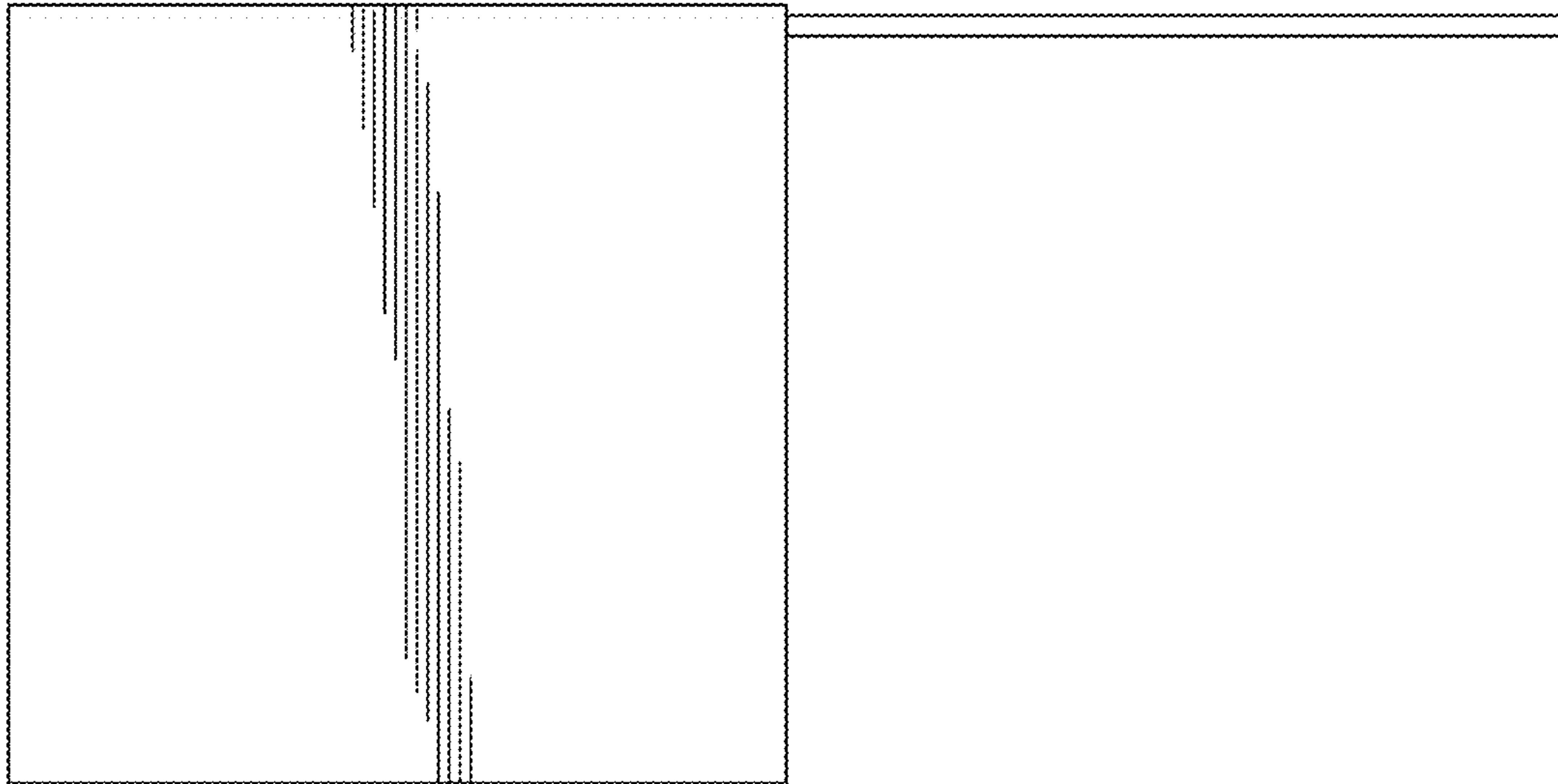

FIG.12

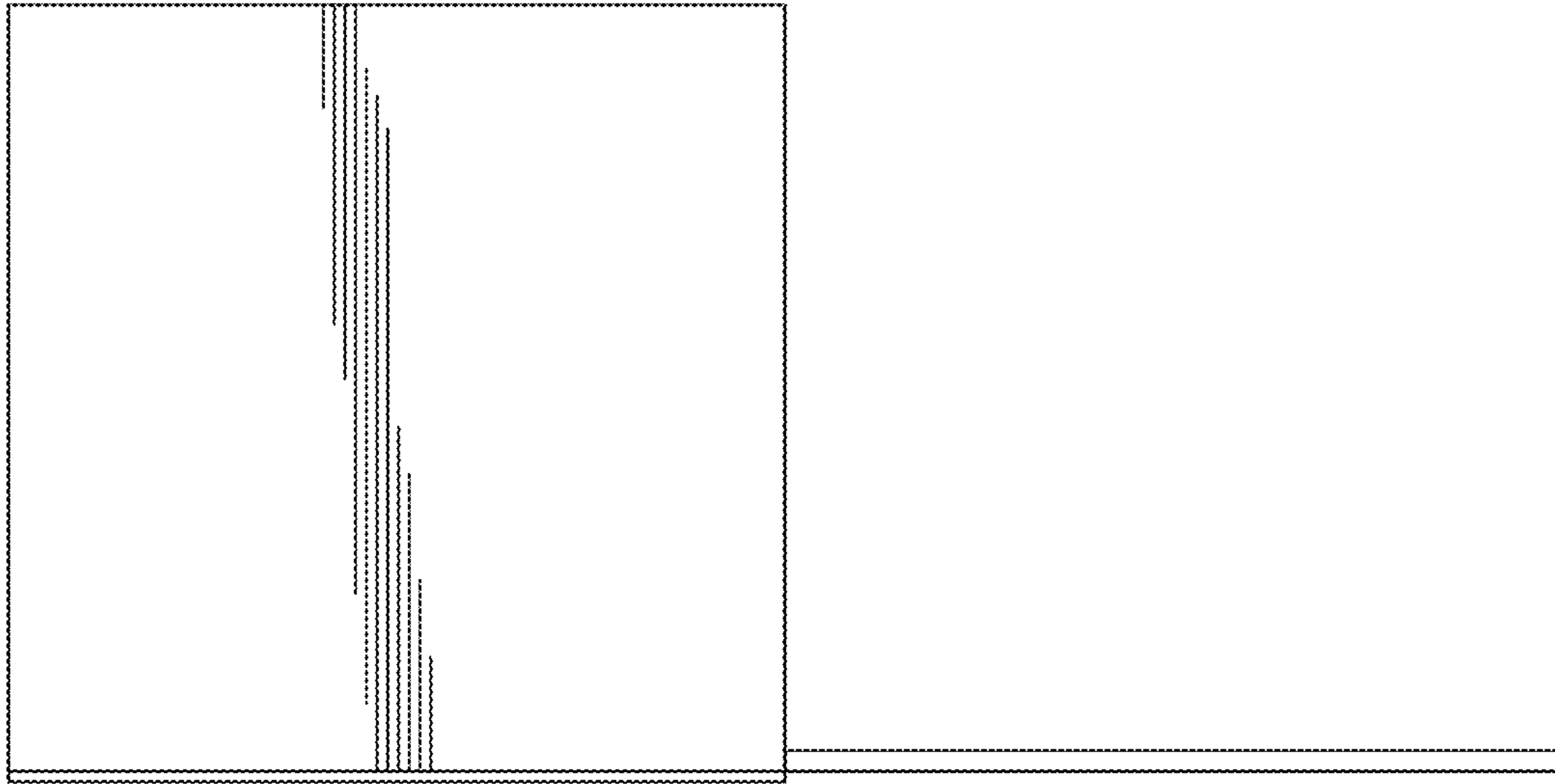

FIG.13

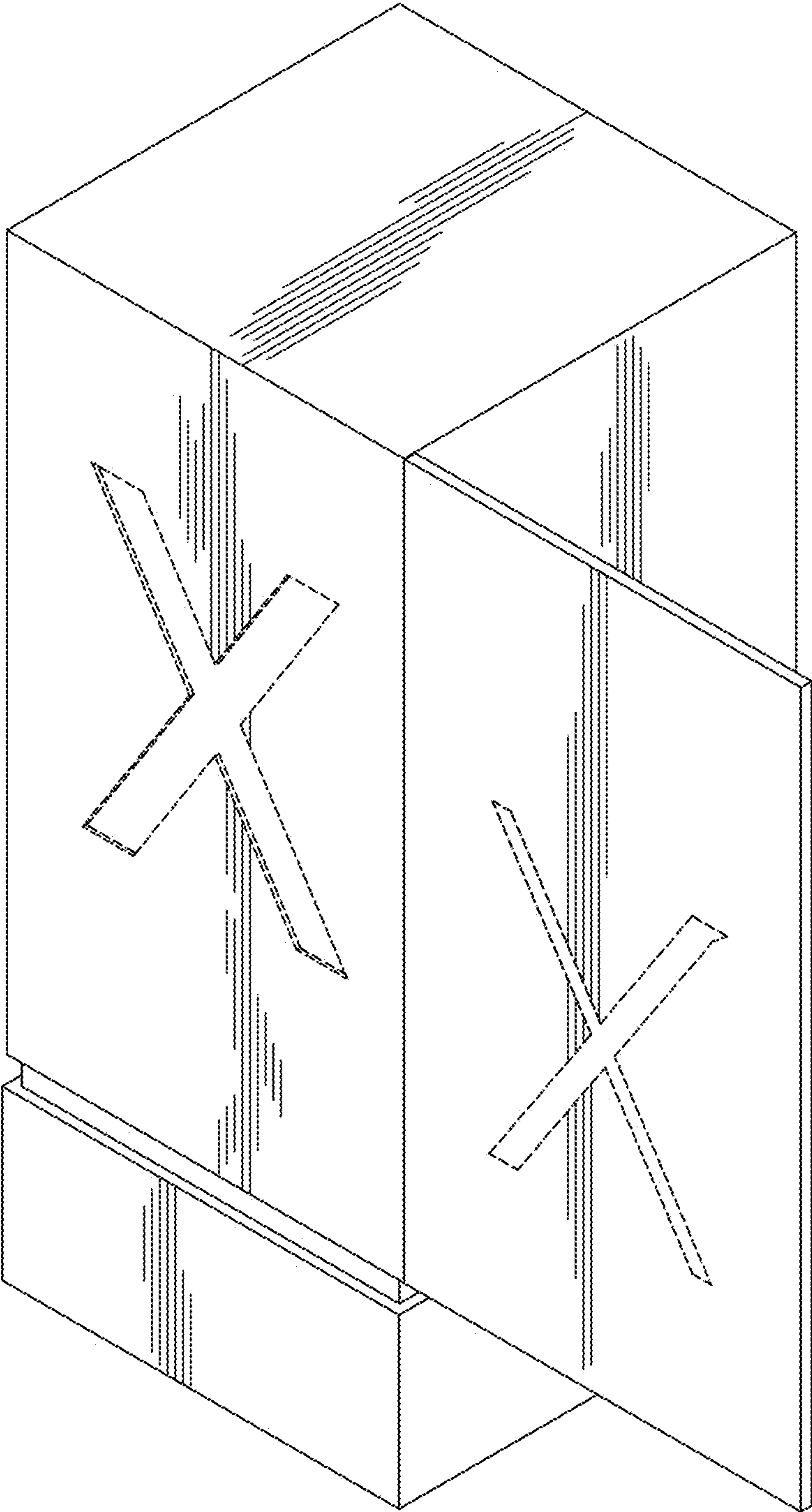

FIG.14

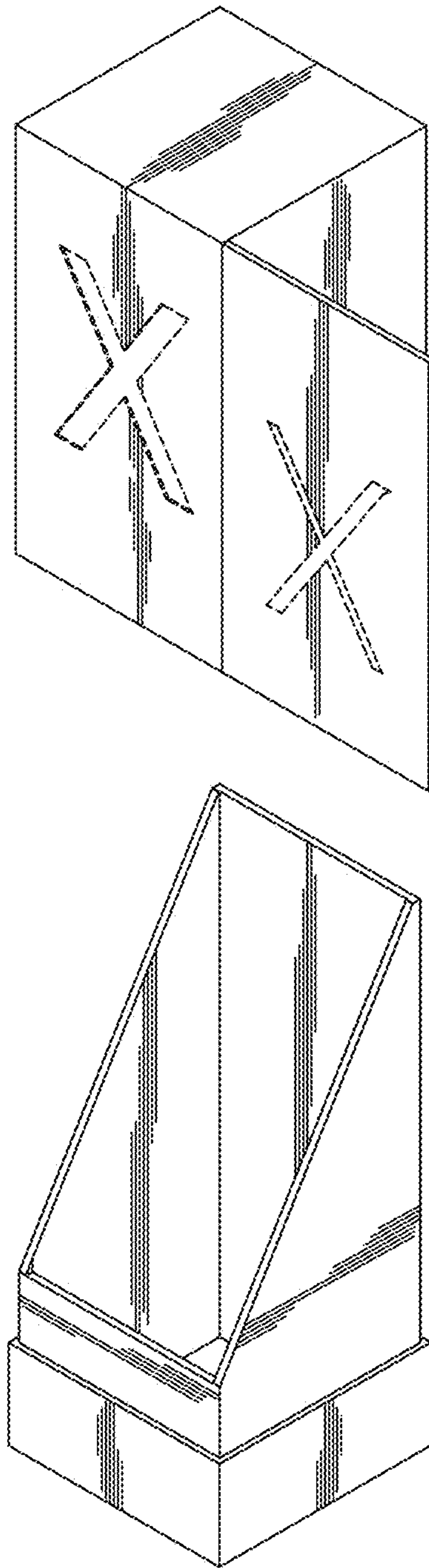

FIG.15

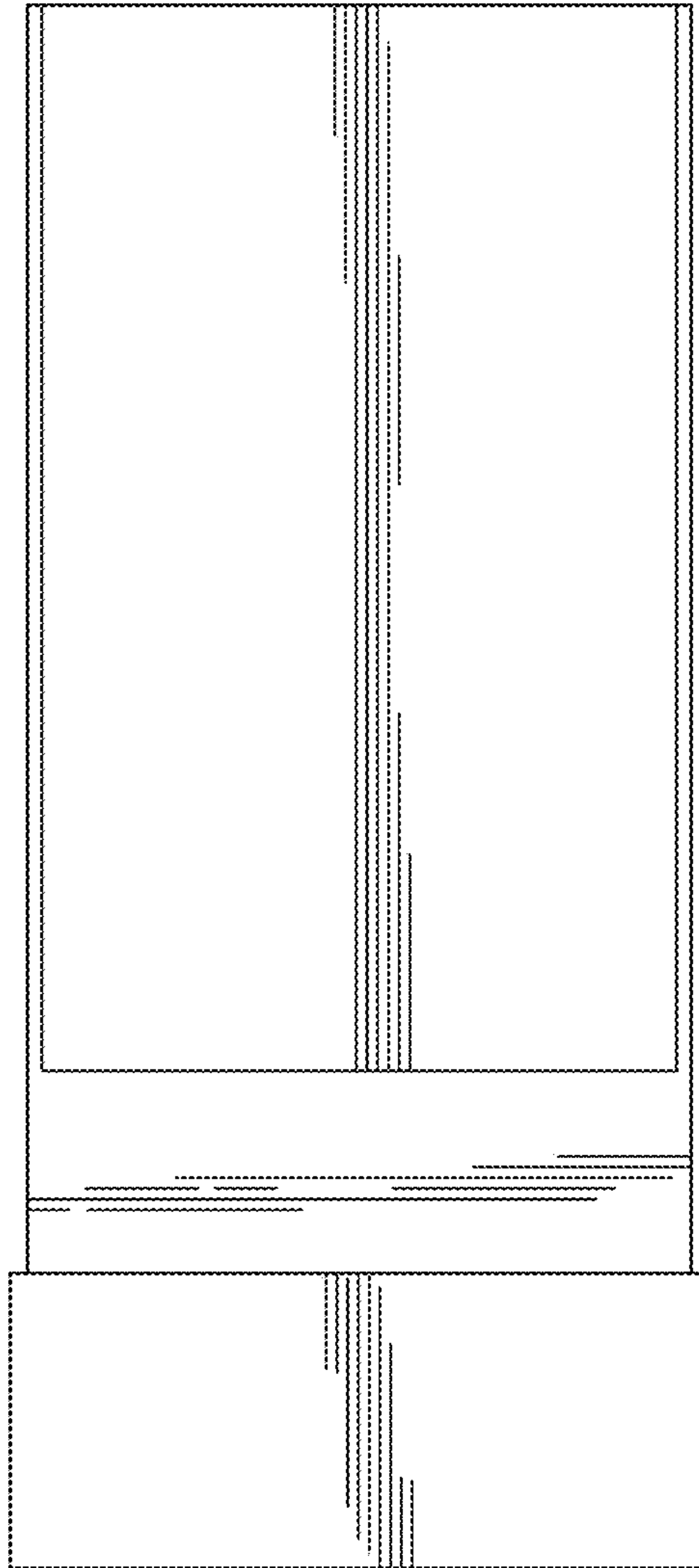

FIG. 16

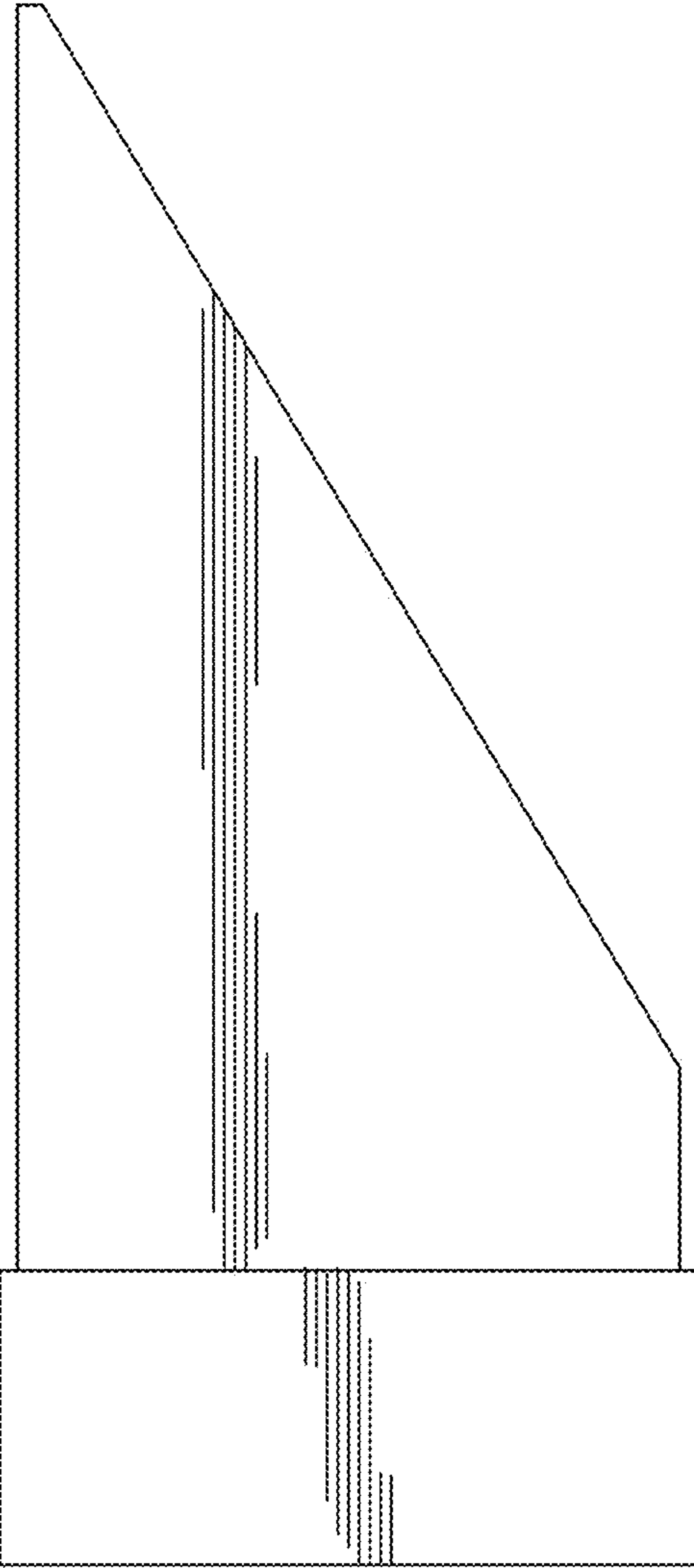

FIG.17

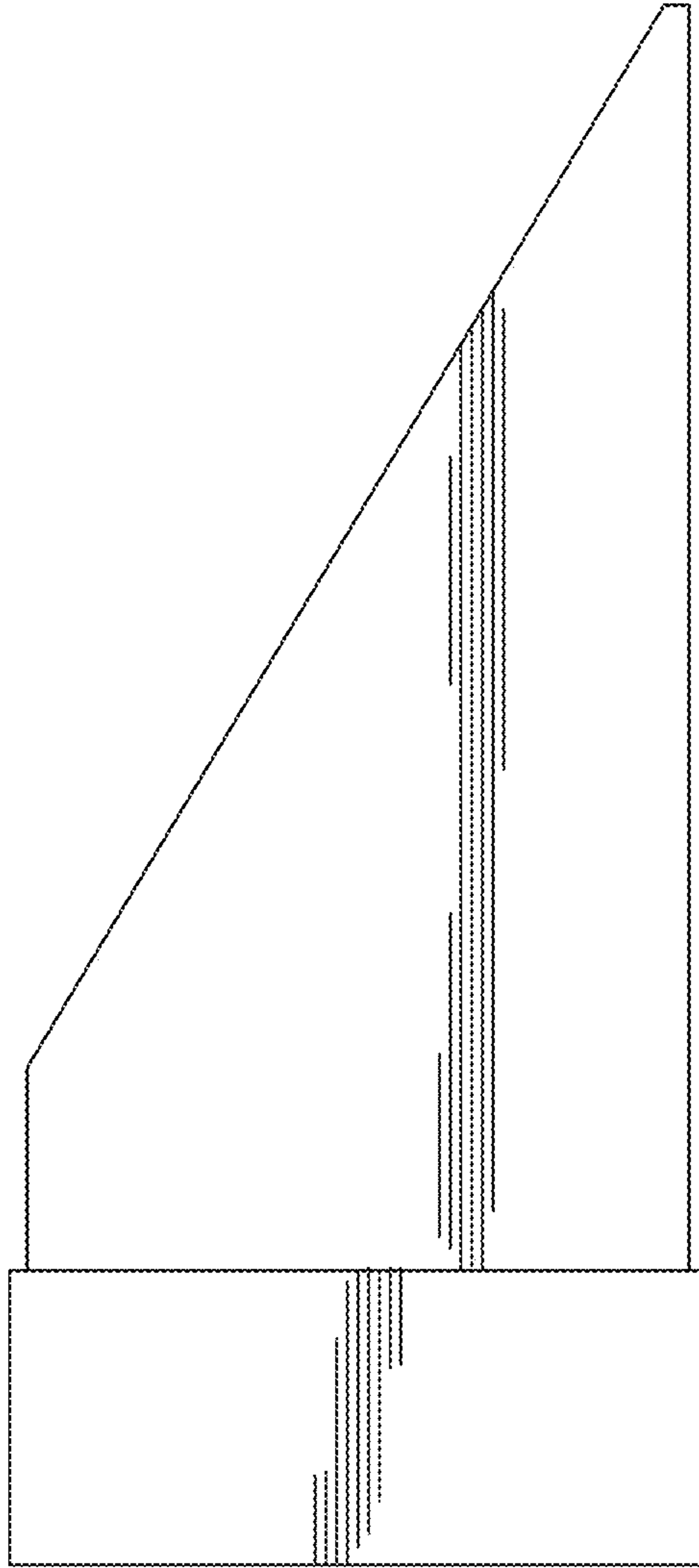

FIG.18

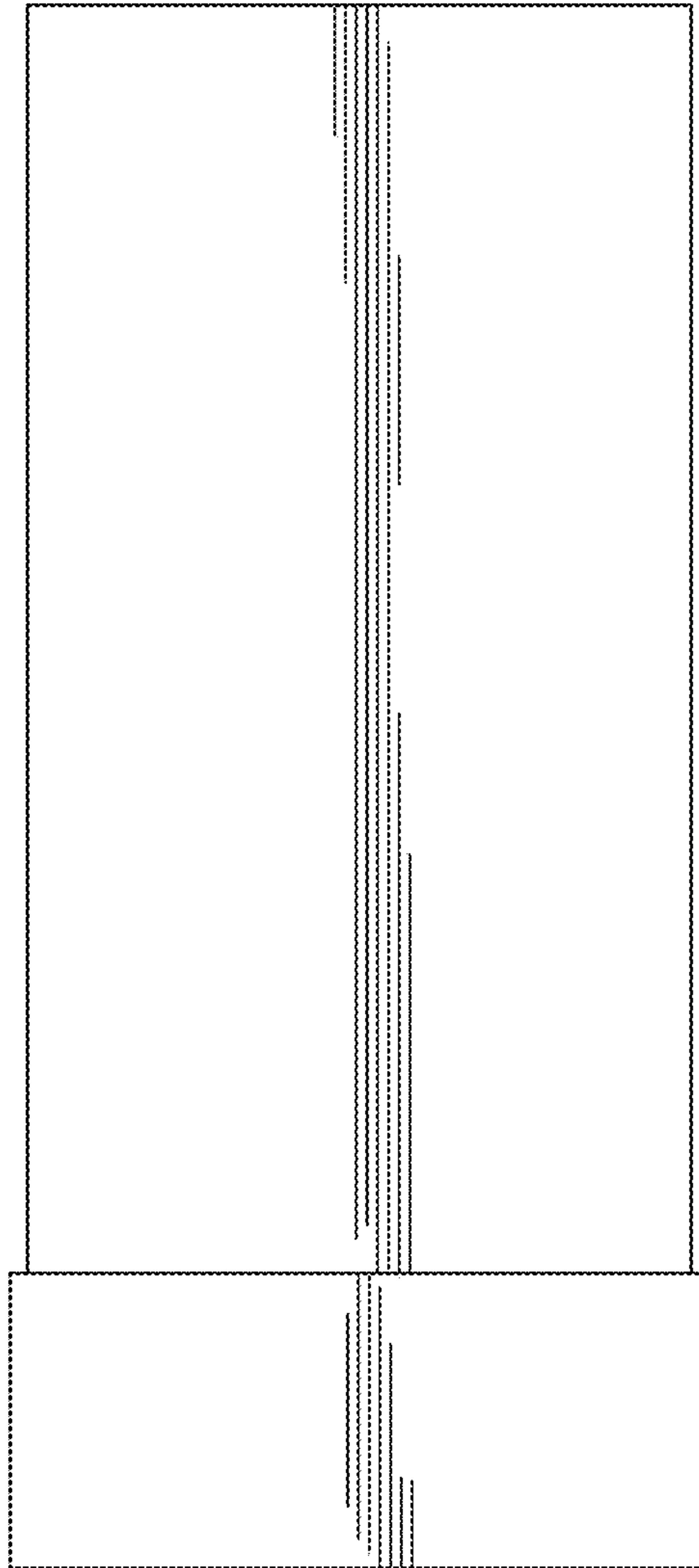

FIG. 19

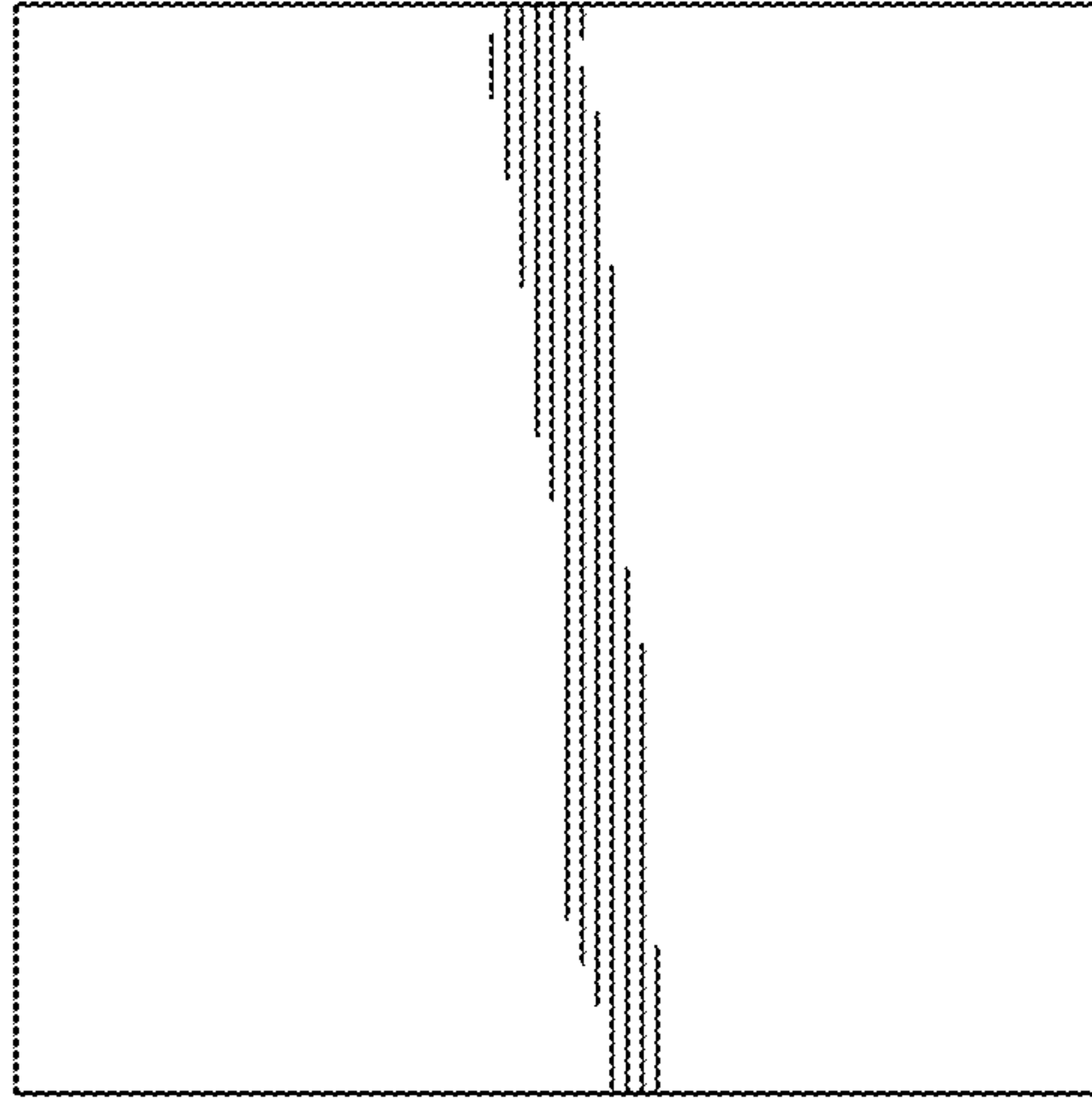

FIG.20

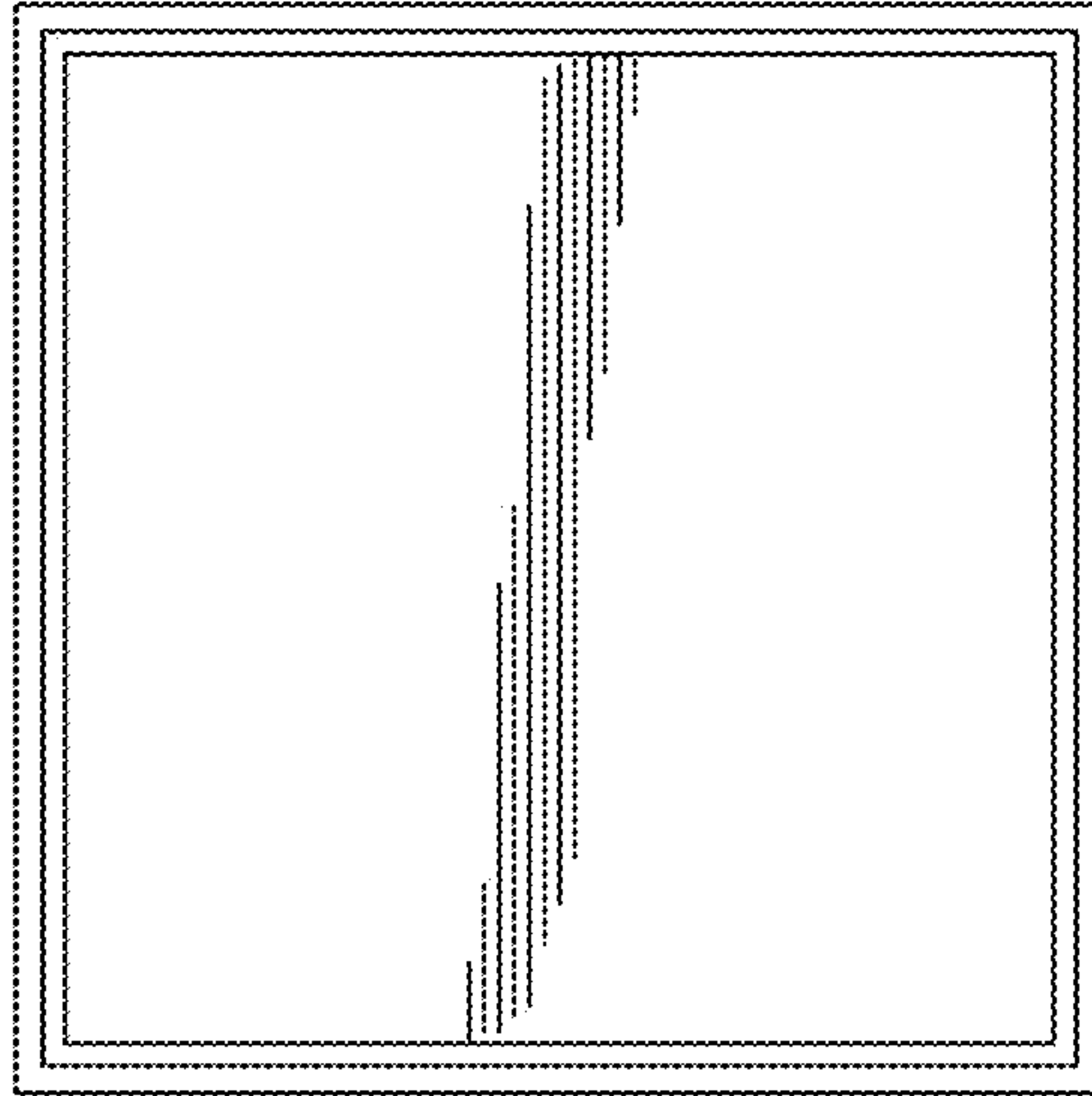

FIG.21