



US00D871870S

(12) **United States Design Patent**
Owen

(10) **Patent No.:** **US D871,870 S**
(45) **Date of Patent:** **** Jan. 7, 2020**

(54) **HANDLE FOR TORQUE WRENCH**
(71) Applicant: **NORBAR TORQUE TOOLS LIMITED**, Banbury, Oxfordshire (GB)
(72) Inventor: **Richard Owen**, Banbury (GB)
(73) Assignee: **NORBAR TORQUE TOOLS LIMITED**, Banbury (GB)

(**) Term: **15 Years**
(21) Appl. No.: **29/655,611**
(22) Filed: **Jul. 5, 2018**

(30) **Foreign Application Priority Data**
Jan. 18, 2018 (GB) 004671063-0002

(51) **LOC (12) Cl.** **08-05**
(52) **U.S. Cl.**
USPC **D8/24**
(58) **Field of Classification Search**
USPC D8/21, 22, 23, 24, 25, 26, 27, 28, 29,
D8/107, 83, 84, 85
CPC B25B 23/1425; B25B 23/1427; B25B
23/142
See application file for complete search history.

(56) **References Cited**
U.S. PATENT DOCUMENTS
6,334,377 B1 * 1/2002 Wu B25B 23/1427
81/478
6,640,674 B1 * 11/2003 Rinner B25B 23/141
81/473
6,722,235 B2 * 4/2004 Hsieh B25B 23/1427
81/478
6,948,410 B1 * 9/2005 Larson B25B 23/1427
173/176
7,044,036 B1 * 5/2006 Salazar B25B 23/1427
81/478

7,047,849 B2 * 5/2006 Lai B25B 23/1425
73/862.23
D586,193 S * 2/2009 Escoe D8/24
D605,482 S * 12/2009 Jenkins D8/24
7,631,583 B2 * 12/2009 Hsieh B25B 23/1425
81/467
7,765,900 B2 * 8/2010 Wu B25B 23/1427
81/467
D702,519 S * 4/2014 Lee D8/24
8,863,624 B2 * 10/2014 Chen B25B 23/1427
81/467
D760,046 S * 6/2016 Caglar D8/24
2010/0050828 A1 * 3/2010 Anjanappa B25B 23/1425
81/467
2011/0113936 A1 * 5/2011 Chiang B25B 23/1427
81/483
2013/0228053 A1 * 9/2013 Chen B25B 23/1427
81/467
2014/0202292 A1 * 7/2014 Chen B25B 13/463
81/478
2016/0144492 A1 * 5/2016 Jiang B25B 23/1425
81/479

(Continued)

Primary Examiner — Philip S Hyder
(74) *Attorney, Agent, or Firm* — Withrow & Terranova,
P.L.L.C.; Vincent K. Gustafson

(57) **CLAIM**
The ornamental design for a handle for torque wrench, as shown and described.

DESCRIPTION

FIG. 1 is a perspective view of the handle for torque wrench showing the ornamental design;
FIG. 2 is a front elevational view thereof;
FIG. 3 is a rear elevational view thereof;
FIG. 4 is a left side elevation view thereof;
FIG. 5 is a right side elevational view thereof;
FIG. 6 is a top plan view thereof; and,
FIG. 7 is a bottom plan view thereof.

1 Claim, 4 Drawing Sheets

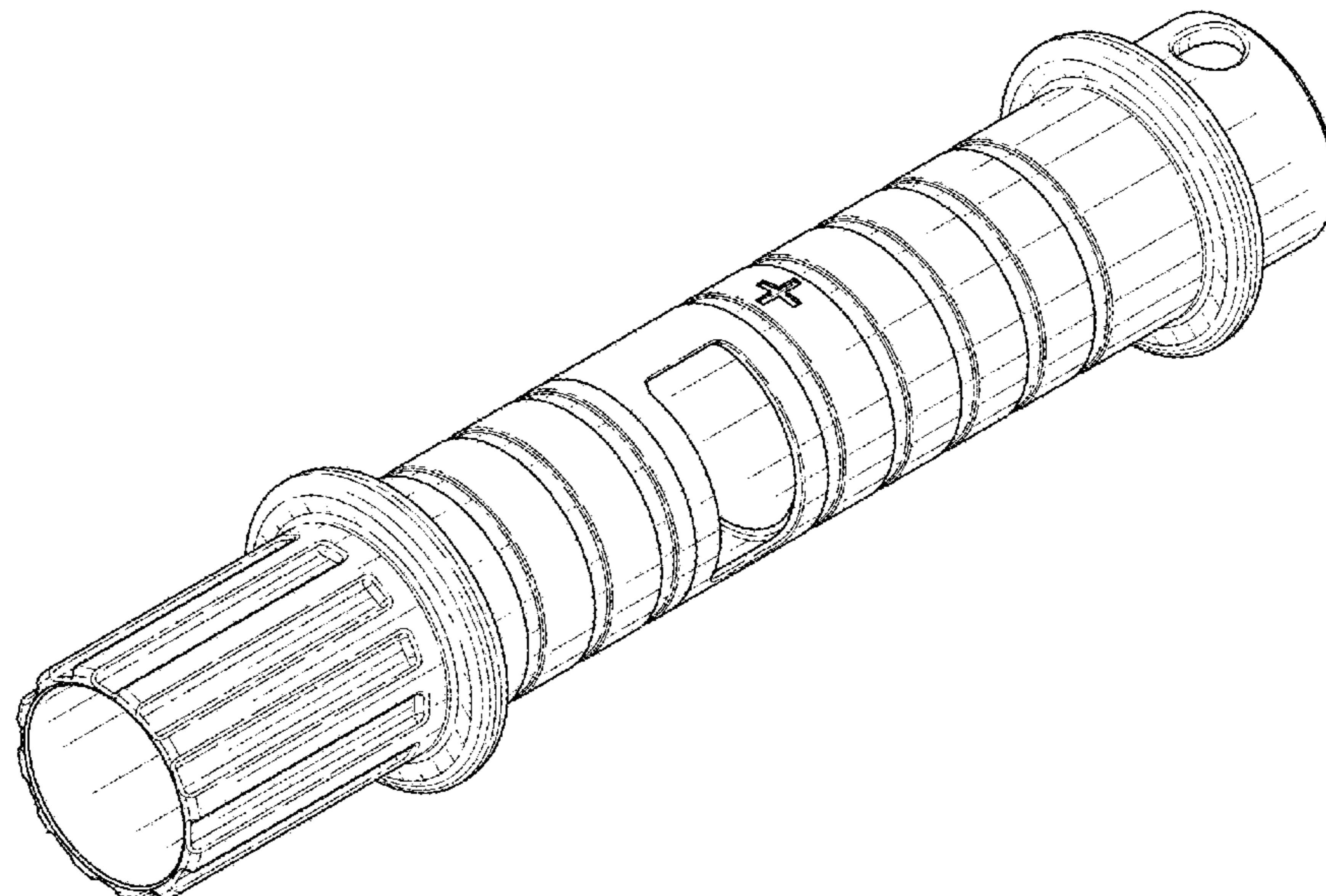

(56)

References Cited

U.S. PATENT DOCUMENTS

2017/0095911 A1* 4/2017 Hsieh B25B 23/1425

* cited by examiner

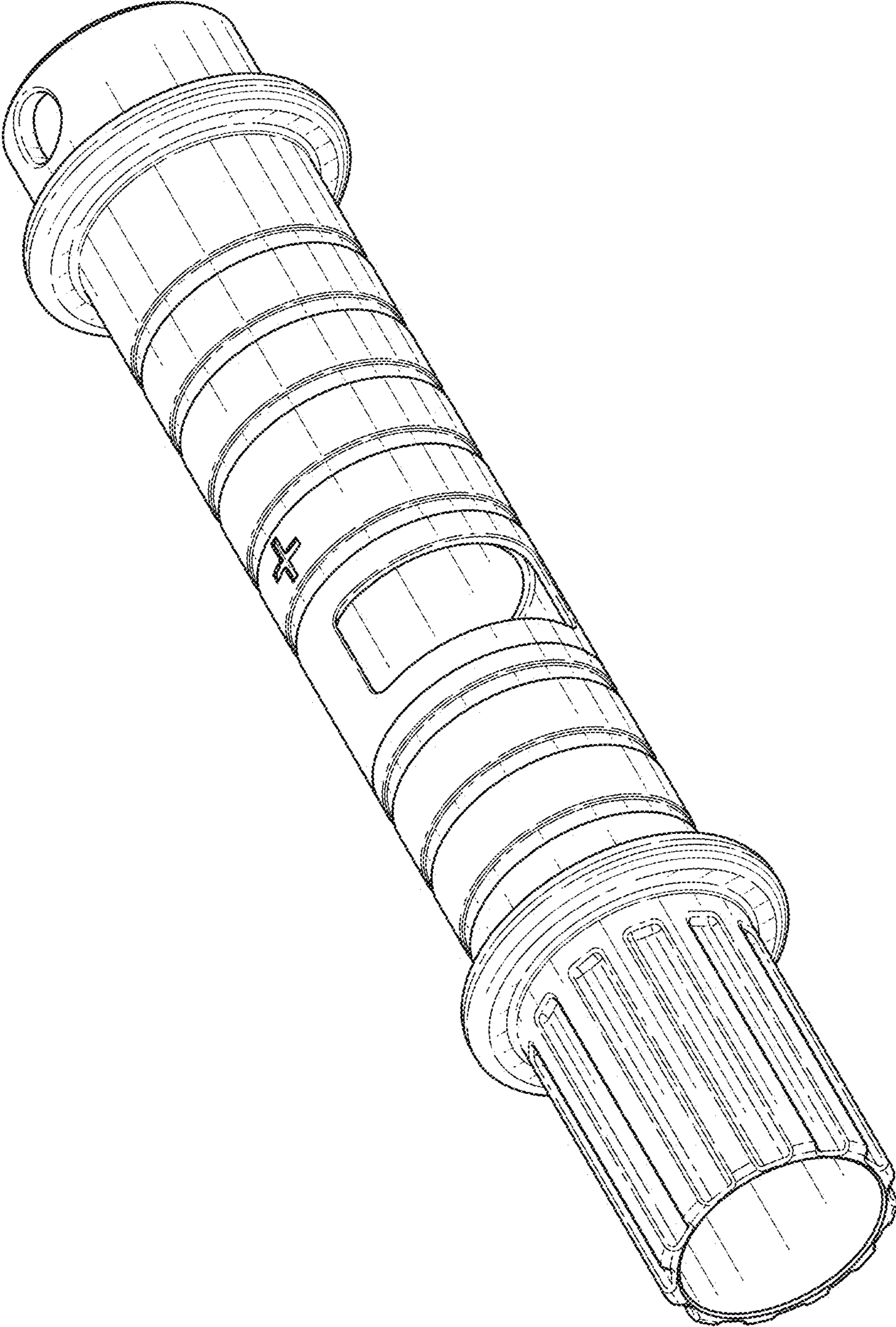

FIG. 1

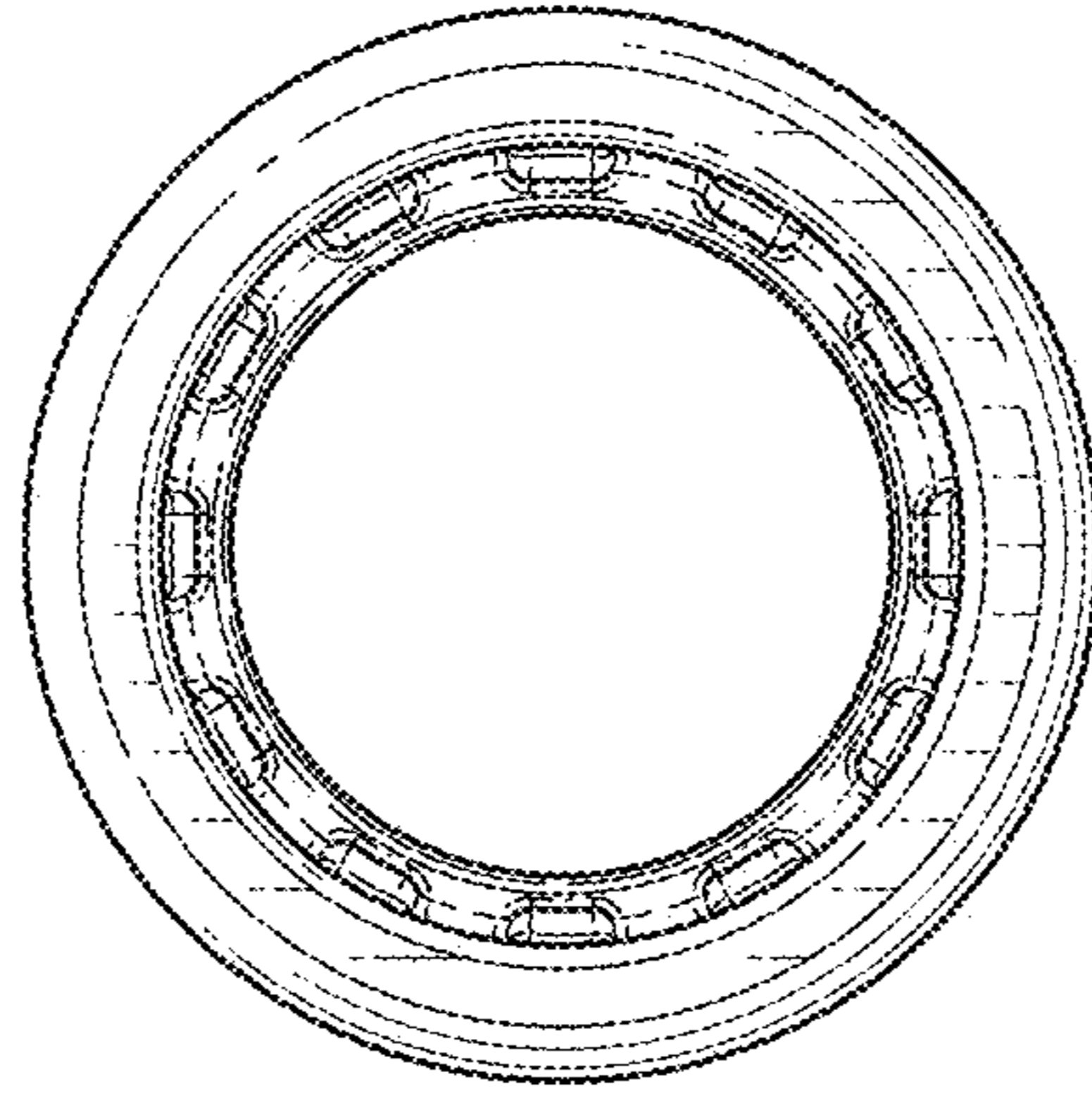

FIG. 2

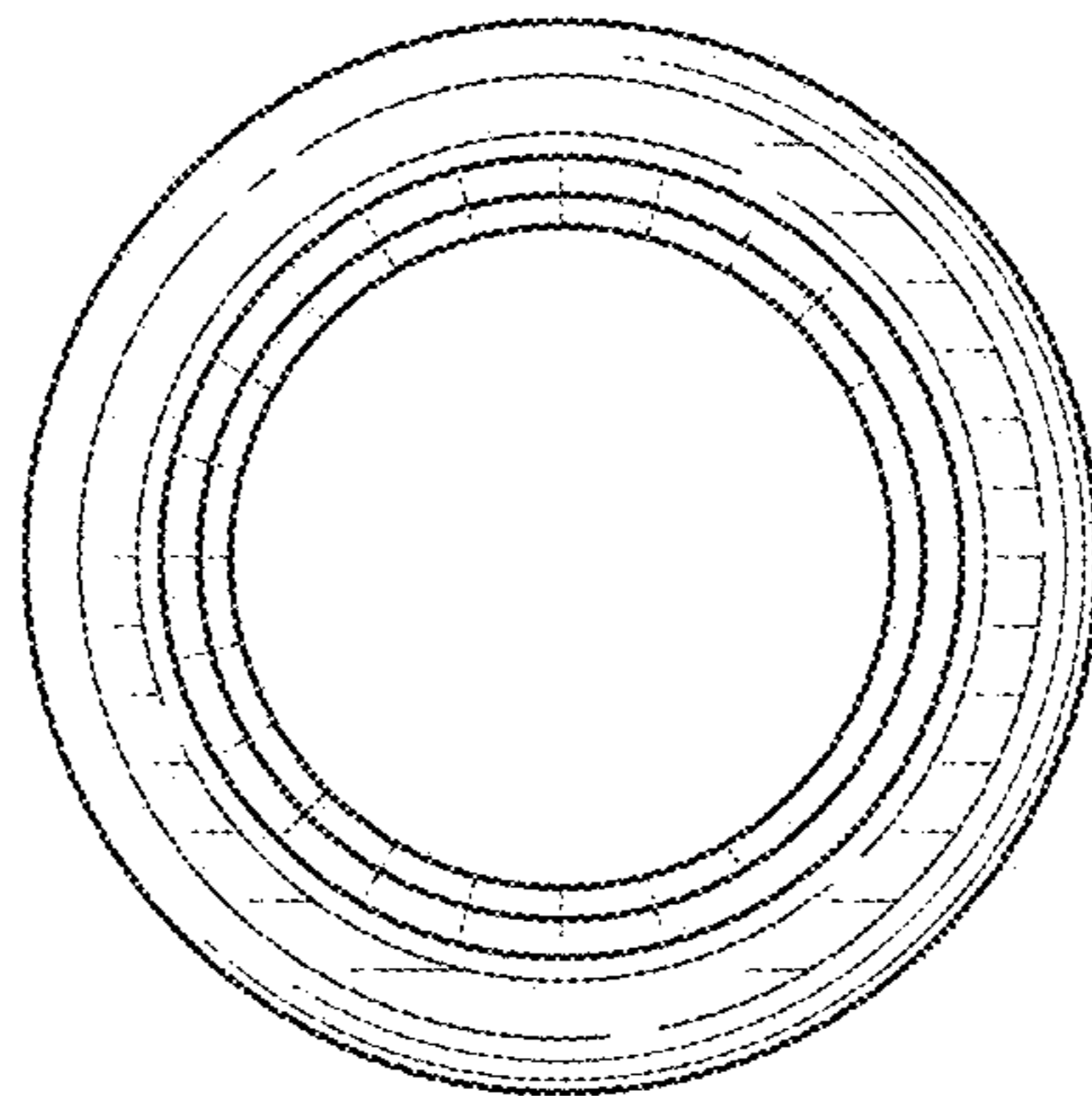

FIG. 3

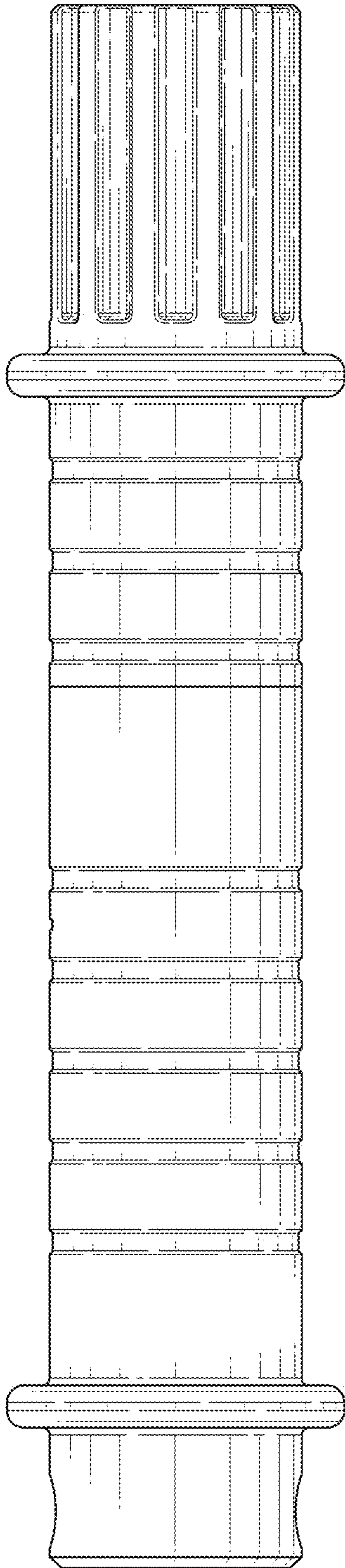

FIG. 4

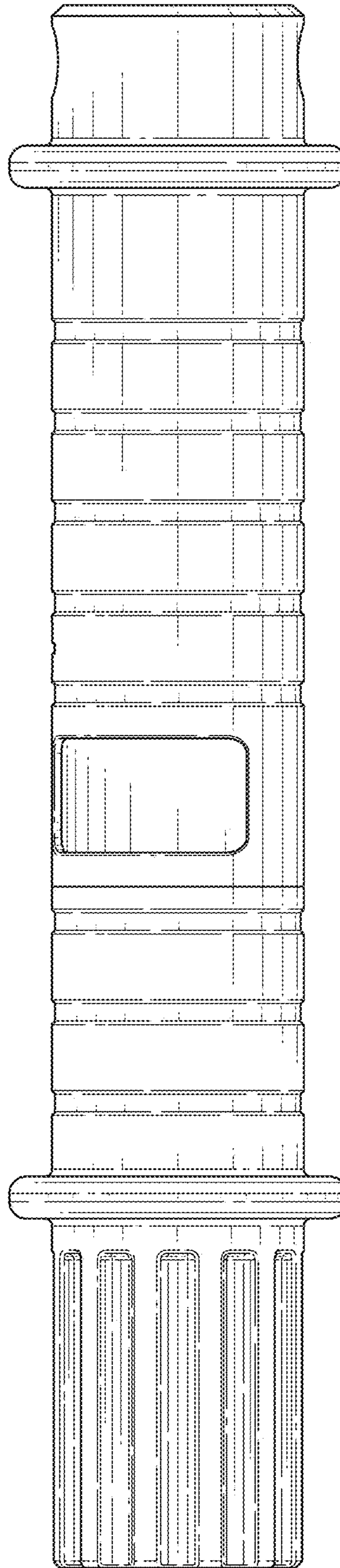

FIG. 5

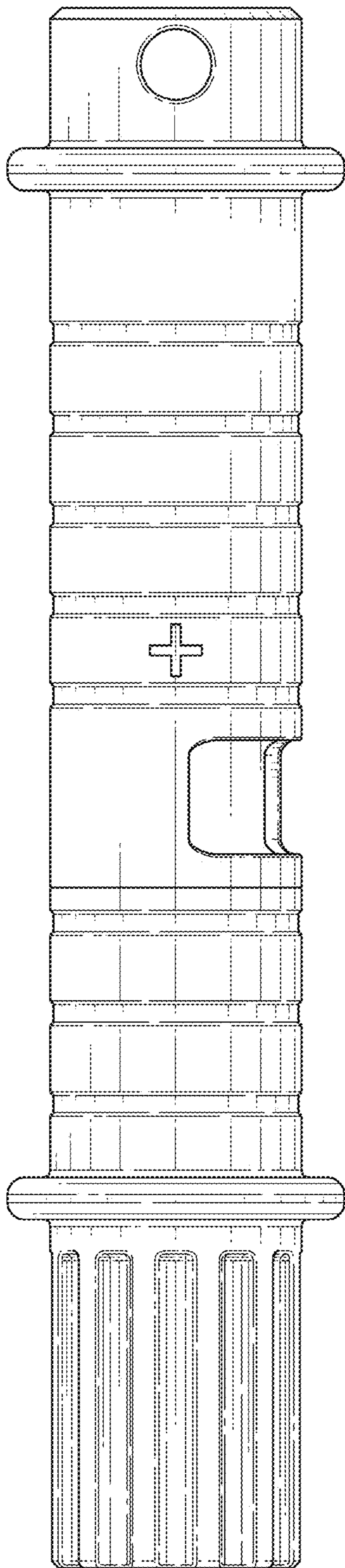

FIG. 6

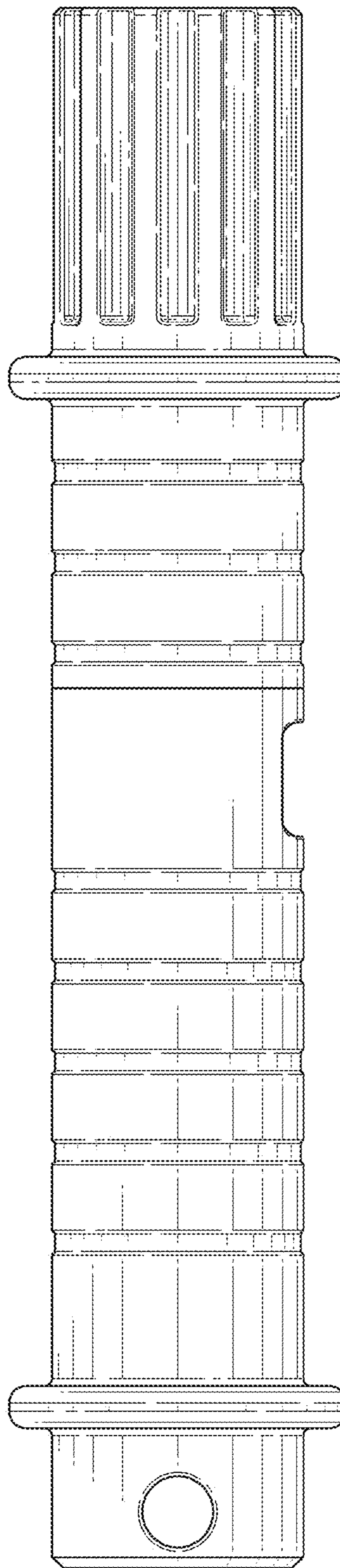

FIG. 7