

US00D871798S

(12) **United States Design Patent**  
**Simmons**

(10) **Patent No.:** **US D871,798 S**

(45) **Date of Patent:** **\*\* Jan. 7, 2020**

(54) **LINEN SHEET AND PILLOW SHEET SET**

(71) Applicant: **Steven Simmons**, Baltimore, MD (US)

(72) Inventor: **Steven Simmons**, Baltimore, MD (US)

(\*\*) Term: **15 Years**

(21) Appl. No.: **29/593,796**

(22) Filed: **Feb. 13, 2017**

(51) **LOC (12) Cl.** ..... **06-13**

(52) **U.S. Cl.**  
USPC ..... **D6/602**

(58) **Field of Classification Search**  
USPC ..... D6/595, 596, 601, 602, 603, 307; 5/495,  
5/489, 490, 491  
CPC ..... A47G 9/02; A47G 9/0207; A47G 9/0223;  
A47G 9/0238; A47G 9/0246; A47G  
9/0253; A47G 9/0261  
See application file for complete search history.

(56) **References Cited**

**U.S. PATENT DOCUMENTS**

- 3,530,487 A \* 9/1970 Beer ..... A47G 9/02  
5/494
- D313,140 S \* 12/1990 Johnson
- 6,237,171 B1 \* 5/2001 Allen ..... A47G 9/0207  
5/482
- 8,214,949 B2 \* 7/2012 Thompson ..... A47D 15/001  
5/494
- D693,787 S \* 11/2013 Reivo ..... D14/138 G
- 8,656,535 B1 \* 2/2014 Adorney ..... A47G 9/0238  
5/495
- D702,205 S \* 4/2014 Joung ..... D14/138 G
- D712,368 S \* 9/2014 Hibi ..... D14/138 G
- D712,861 S \* 9/2014 Fujimura ..... D14/138 G
- D712,863 S \* 9/2014 Kang ..... D14/138 G
- D713,373 S \* 9/2014 Hibi ..... D14/138 G
- D716,746 S \* 11/2014 Du ..... D14/138 G
- D716,747 S \* 11/2014 Kleiner ..... D14/138 G
- D721,668 S \* 1/2015 Fujimura ..... D14/138 G

- D722,038 S \* 2/2015 Cheng ..... D14/138 G
- D724,044 S \* 3/2015 Reivo ..... D14/138 G
- D724,045 S \* 3/2015 Fujimura ..... D14/138 G
- D729,189 S \* 5/2015 Kangasmaa ..... D14/138 G
- D730,859 S \* 6/2015 Kaneta ..... D14/138 G
- D730,863 S \* 6/2015 Yamagishi ..... D14/138 G
- D736,735 S \* 8/2015 Ishii ..... D14/138 G
- D737,795 S \* 9/2015 Huang ..... D14/138 G
- D737,815 S \* 9/2015 Finney ..... D14/138 G
- D738,343 S \* 9/2015 Shao ..... D14/138 G
- D738,844 S \* 9/2015 Lee ..... D14/138 AD
- D740,777 S \* 10/2015 Kim ..... D14/138 G
- D742,347 S \* 11/2015 Kim ..... D14/138 G
- D742,348 S \* 11/2015 Park ..... D14/138 G
- D742,350 S \* 11/2015 Lee ..... D14/138 G

(Continued)

*Primary Examiner* — Michelle E. Wilson

*Assistant Examiner* — Sanjeev Paul

(74) *Attorney, Agent, or Firm* — Dunlap Bennett & Ludwig PLLC

(57) **CLAIM**

The ornamental design for a linen sheet and pillow sheet set, as shown and described.

**DESCRIPTION**

FIG. 1 is a front perspective view of a linen sheet and pillow sheet set;  
 FIG. 2 is a front elevation view thereof;  
 FIG. 3 is a rear elevation view thereof;  
 FIG. 4 is a left side elevation view thereof;  
 FIG. 5 is a right side elevation view thereof;  
 FIG. 6 is a top plan view thereof;  
 FIG. 7 is a bottom plan view thereof; and,  
 FIG. 8 is an enlarged cross sectional view thereof, taken along line 8-8 in FIG. 6.  
 The broken lines represent the bounds of the claimed design, it being understood that the broken lines form no part of the claimed design.

**1 Claim, 6 Drawing Sheets**

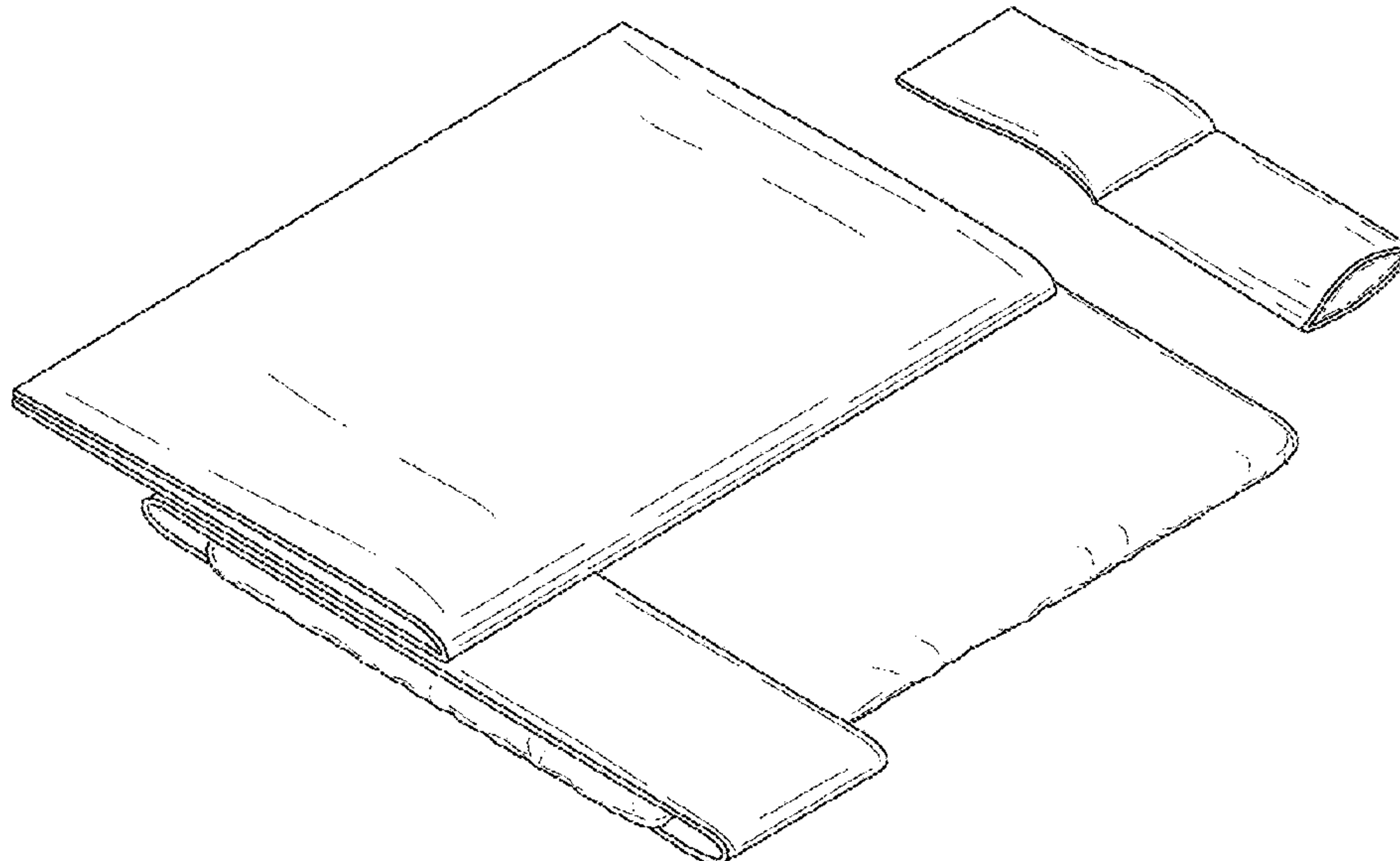

(56)

**References Cited**

U.S. PATENT DOCUMENTS

D742,847 S \* 11/2015 Ryu ..... D14/138 G  
D742,848 S \* 11/2015 Hachiya ..... D14/138 G  
D744,447 S \* 12/2015 Ryu ..... D14/138 G  
D744,450 S \* 12/2015 Kim ..... D14/138 G  
D745,483 S \* 12/2015 Dhondt ..... D14/138 G  
D745,855 S \* 12/2015 Chu ..... D14/138 G  
D746,248 S \* 12/2015 Arnholt ..... D14/138 G  
D746,249 S \* 12/2015 Park ..... D14/138 G  
9,265,368 B2 \* 2/2016 Blethen ..... A47G 9/0238  
D832,619 S \* 11/2018 Pacquette ..... D6/602  
2004/0187211 A1 \* 9/2004 Wootten, Jr. .... A47G 9/0207  
5/497

\* cited by examiner

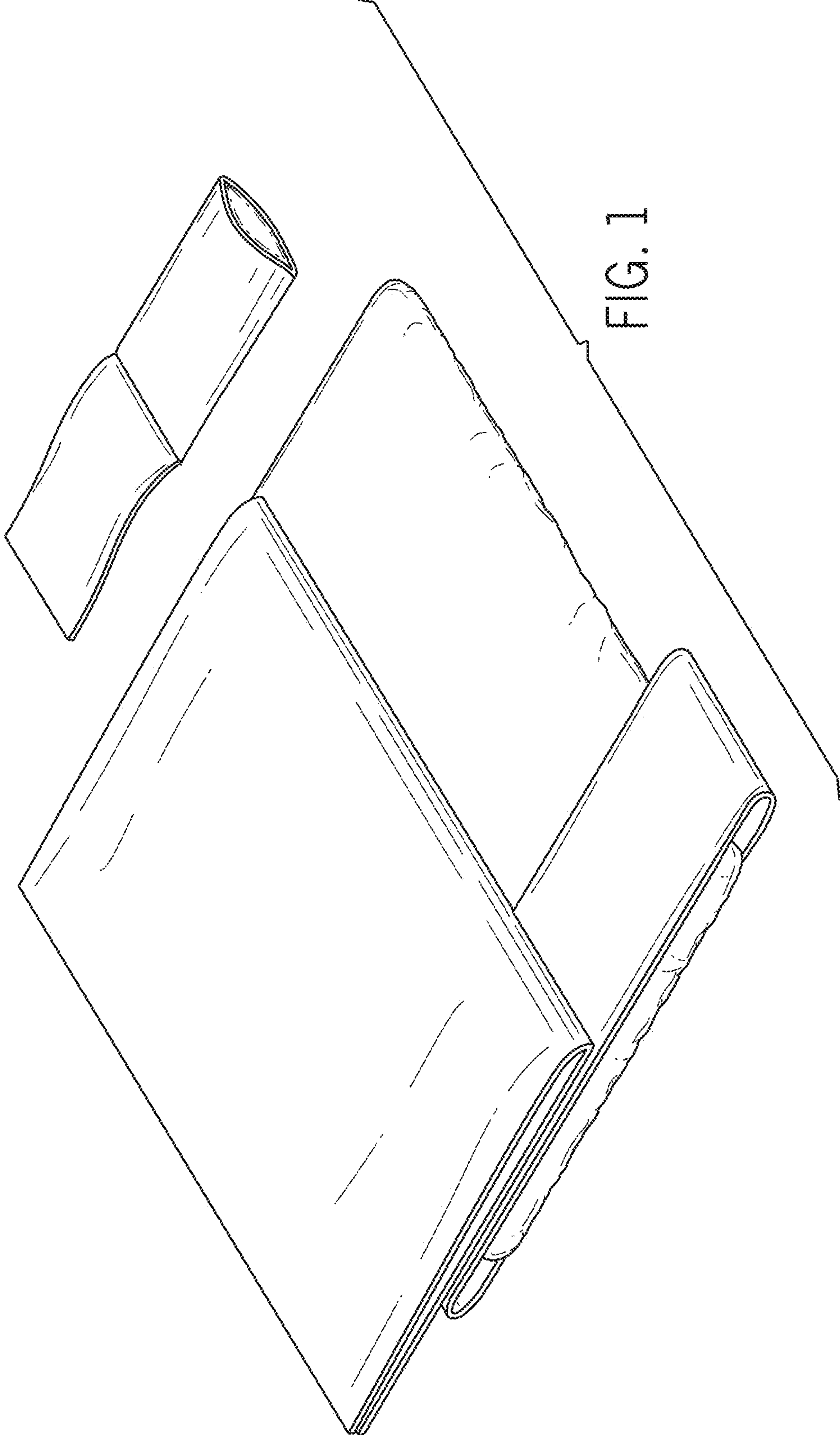

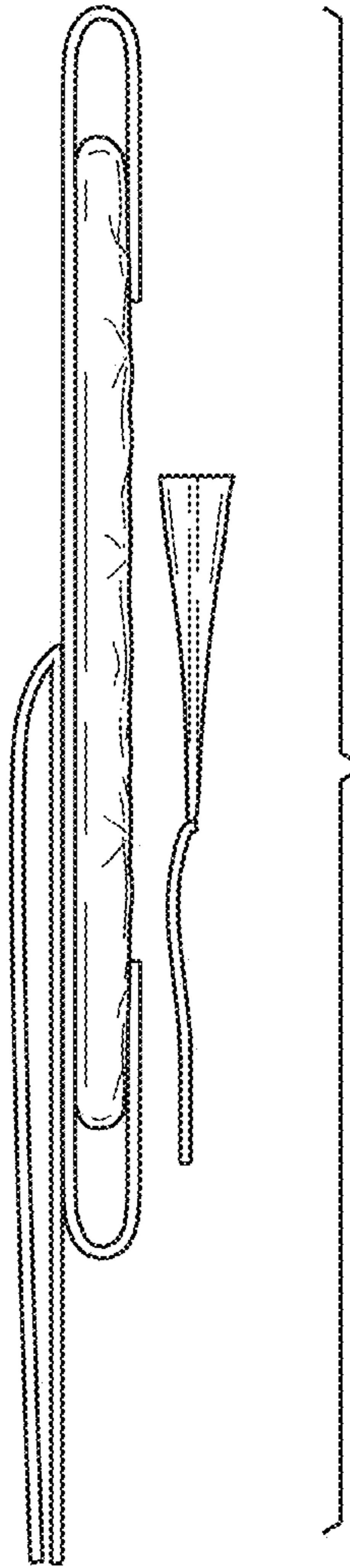

FIG. 2

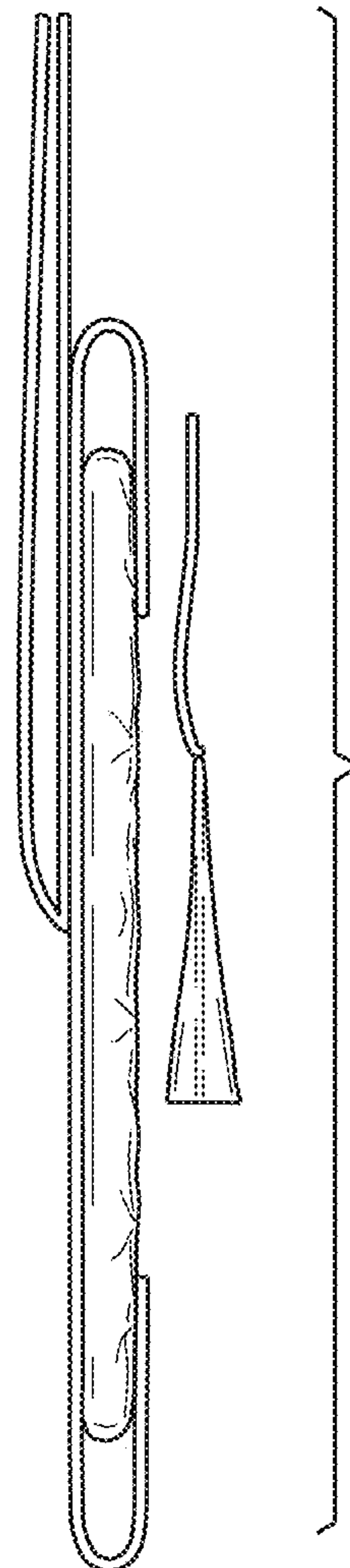

FIG. 3

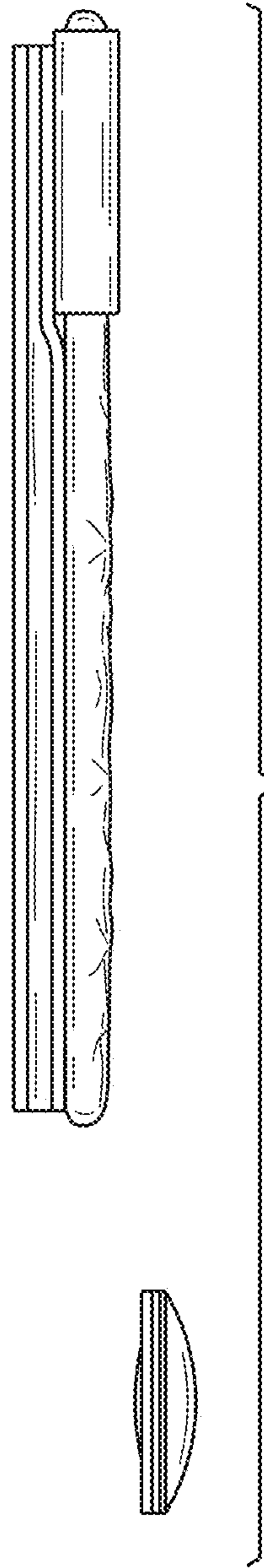

FIG. 4

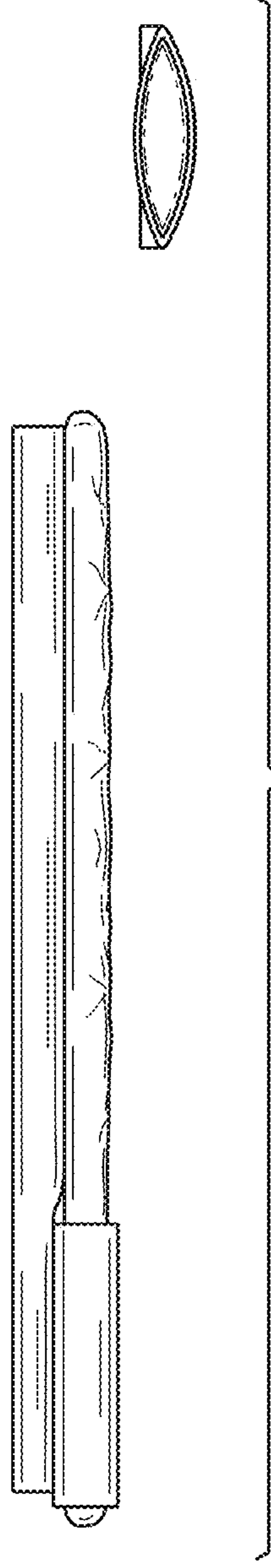

FIG. 5



FIG. 6

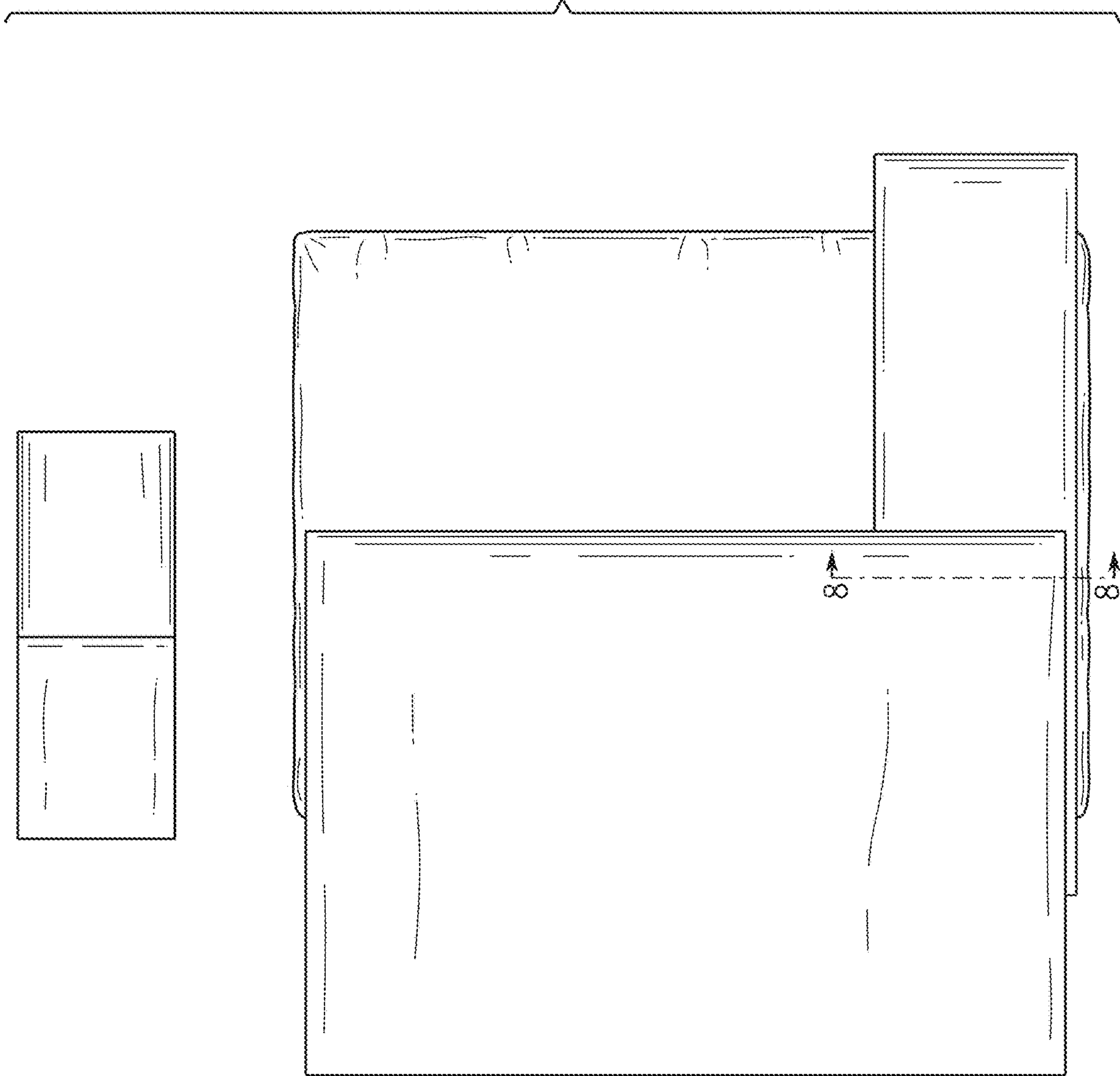
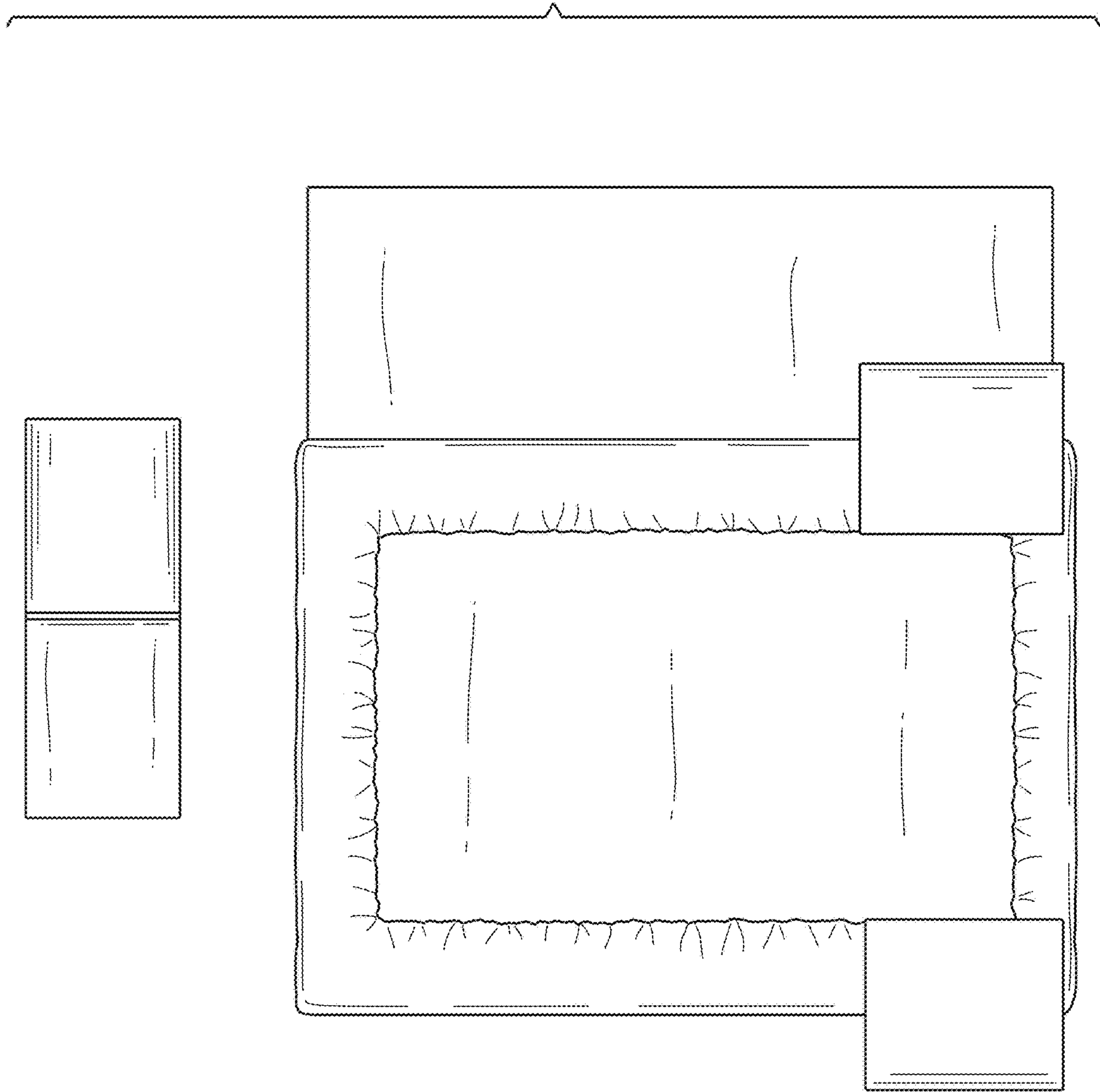

FIG. 7



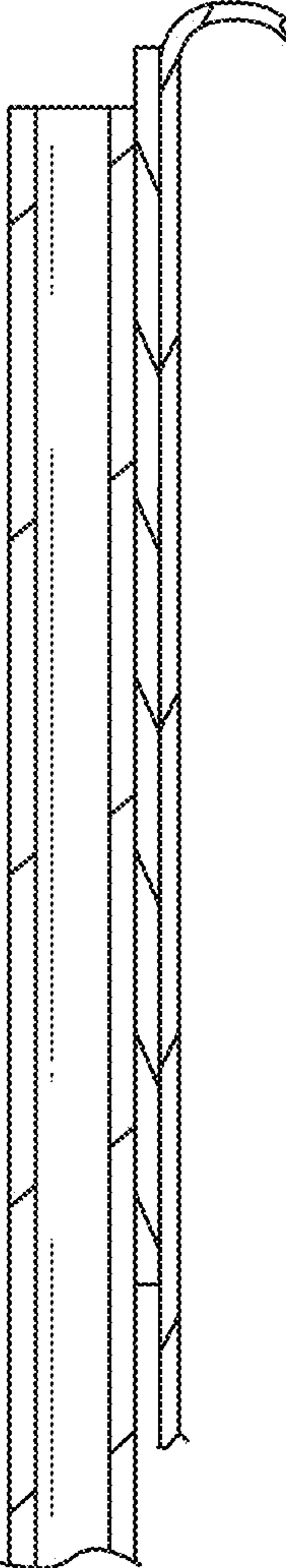

FIG. 8