



US00D871772S

(12) **United States Design Patent** (10) **Patent No.:** **US D871,772 S**
Jimenez et al. (45) **Date of Patent:** **** Jan. 7, 2020**

(54) **TOOTHBRUSH**

(71) Applicant: **Colgate-Palmolive Company**, New York, NY (US)

(72) Inventors: **Eduardo Jimenez**, Manalapan, NJ (US); **Dario Alejandro Narvaez Lopez**, North Bergen, NJ (US); **Anthony Baxter**, Upper Montclair, NJ (US); **Mauricio Issa Llano**, Queens, NY (US)

(73) Assignee: **Colgate-Palmolive Company**, New York, NY (US)

(**) Term: **15 Years**

(21) Appl. No.: **29/686,890**

(22) Filed: **Apr. 9, 2019**

Related U.S. Application Data

(62) Division of application No. 29/657,553, filed on Jul. 24, 2018, now Pat. No. Des. 850,797, which is a division of application No. 29/606,140, filed on Jun. 1, 2017, now Pat. No. Des. 826,570.

(51) **LOC (12) Cl.** **04-02**

(52) **U.S. Cl.**
USPC **D4/107**

(58) **Field of Classification Search**

USPC D4/100, 101, 102, 103, 104, 105, 106, D4/107, 108, 109, 110, 111, 112, 113, D4/114, 115, 116, 117, 118, 119, 120, D4/121, 122, 123, 124, 125, 126, 127, D4/128, 129, 130, 131, 132, 133, 134, D4/135, 136, 137, 138, 199; D24/194, D24/195

CPC A46B 9/02; A46B 9/04; A46B 15/0081; A46B 2200/1066; A46B 2200/1073; A46B 5/02; A46B 9/026

See application file for complete search history.

(56) **References Cited**

U.S. PATENT DOCUMENTS

D61,370	S	*	8/1922	Karfiol	D5/11
D229,903	S	*	1/1974	Ceniceros	D4/107
D264,630	S	*	5/1982	Nakao	D24/195
D274,018	S	*	5/1984	Usui	D4/105
5,138,737	A	*	8/1992	Thomas	A46B 5/02 15/143.1
D329,703	S	*	9/1992	Wilson	D24/194

(Continued)

FOREIGN PATENT DOCUMENTS

CN	302538313	*	8/2013
CN	304254099	S	8/2017

(Continued)

OTHER PUBLICATIONS

Baby Banana Teething Toothbrush for Infants, <http://www.babybananabrush.com/product-category/brushes-and-teethers/>, downloaded from the internet prior to the date of this application, 2 pages.

Primary Examiner — Karen E Eldridge Powers

(57) **CLAIM**

The ornamental design for a toothbrush, as shown and described.

DESCRIPTION

FIG. 1 is a front right perspective view of a toothbrush according to the new design;
FIG. 2 is a rear left perspective view thereof;
FIG. 3 is a front elevation view thereof;
FIG. 4 is a rear elevation view thereof;
FIG. 5 is a right side elevation view thereof;
FIG. 6 is a left side elevation view thereof;
FIG. 7 is a top plan view thereof; and,
FIG. 8 is a bottom plan view thereof.

1 Claim, 6 Drawing Sheets

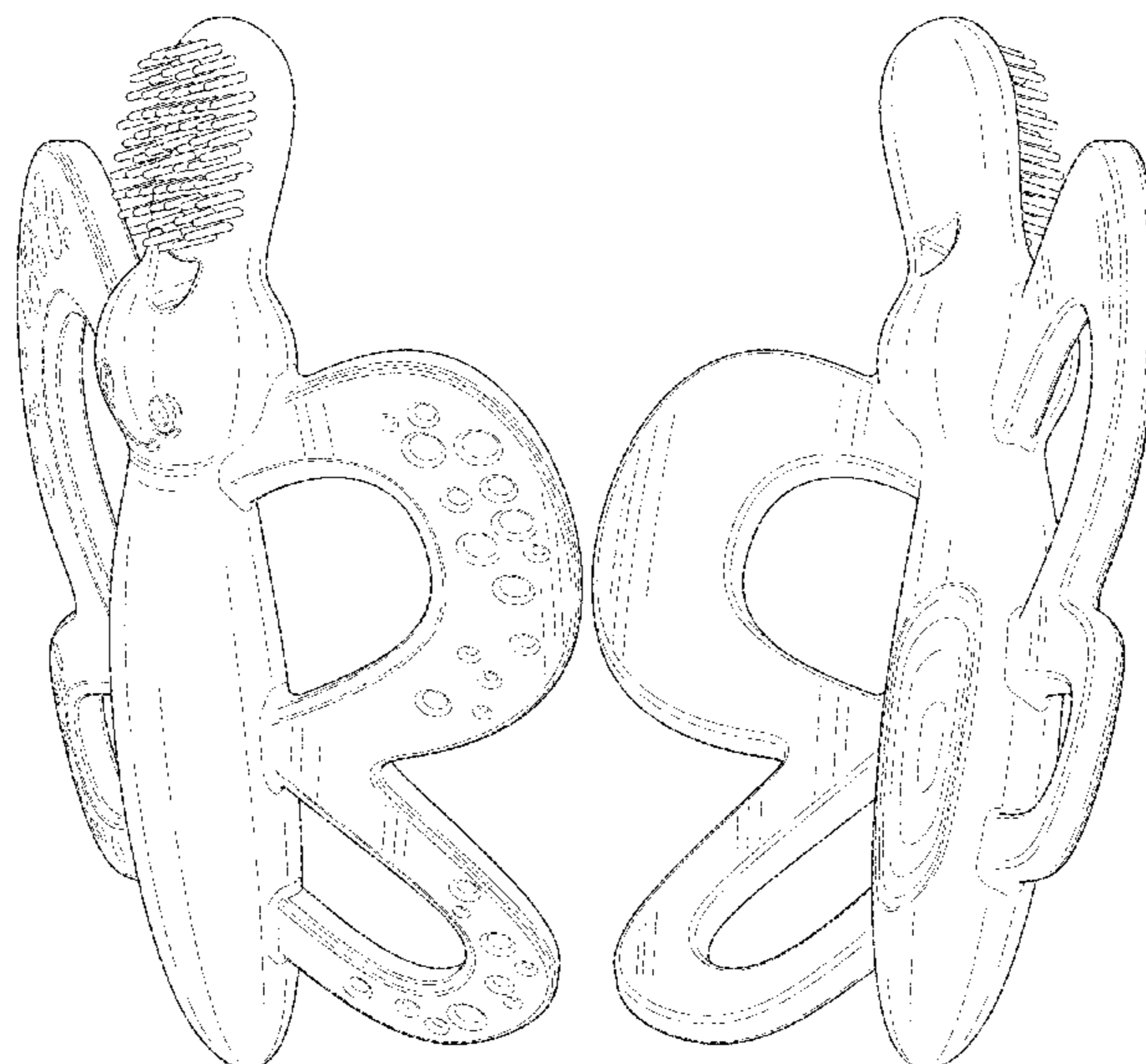

(56)

References Cited

U.S. PATENT DOCUMENTS

D340,525 S * 10/1993 Rohrig D24/194
 5,531,582 A * 7/1996 Klinkhammer A46B 3/005
 249/141
 D375,793 S * 11/1996 Owen D24/195
 5,683,421 A * 11/1997 Guarini, Jr. A61J 17/02
 601/142
 D391,363 S * 2/1998 Rohrig D24/193
 D404,921 S * 2/1999 Smith D4/104
 5,954,749 A * 9/1999 Fields A61J 17/001
 606/234
 D441,195 S 5/2001 Crisio, Jr.
 D476,182 S * 6/2003 Hensel D6/534
 6,695,869 B2 * 2/2004 Fitzpatrick A61J 17/001
 606/234
 D566,400 S 4/2008 Phillips et al.
 D580,174 S 11/2008 Jacobs et al.
 D619,370 S 7/2010 Tegeder et al.
 D623,413 S * 9/2010 Blanchard D4/104

8,066,738 B2 * 11/2011 Kliegman A61J 17/001
 606/234
 D688,046 S 8/2013 Aslett et al.
 D706,034 S * 6/2014 Blachford D4/107
 D710,615 S * 8/2014 Pereira D4/104
 9,173,476 B2 * 11/2015 Minano Fernandez
 A46B 9/045
 D745,283 S 12/2015 Phillips et al.
 D778,616 S 2/2017 Tegeder et al.
 9,826,822 B2 * 11/2017 Geiberger A46B 5/007
 D850,797 S * 6/2019 Jimenez D4/107
 10,306,975 B2 * 6/2019 Jimenez A46B 5/023
 D856,684 S * 8/2019 Jimenez D4/138
 2010/0319149 A1 12/2010 Phillips
 2019/0239634 A1 * 8/2019 Jimenez A46B 5/0033

FOREIGN PATENT DOCUMENTS

JP D1246249 * 8/2005
 TW D153814 S 6/2013
 WO WO-D089878-002 * 6/2016

* cited by examiner

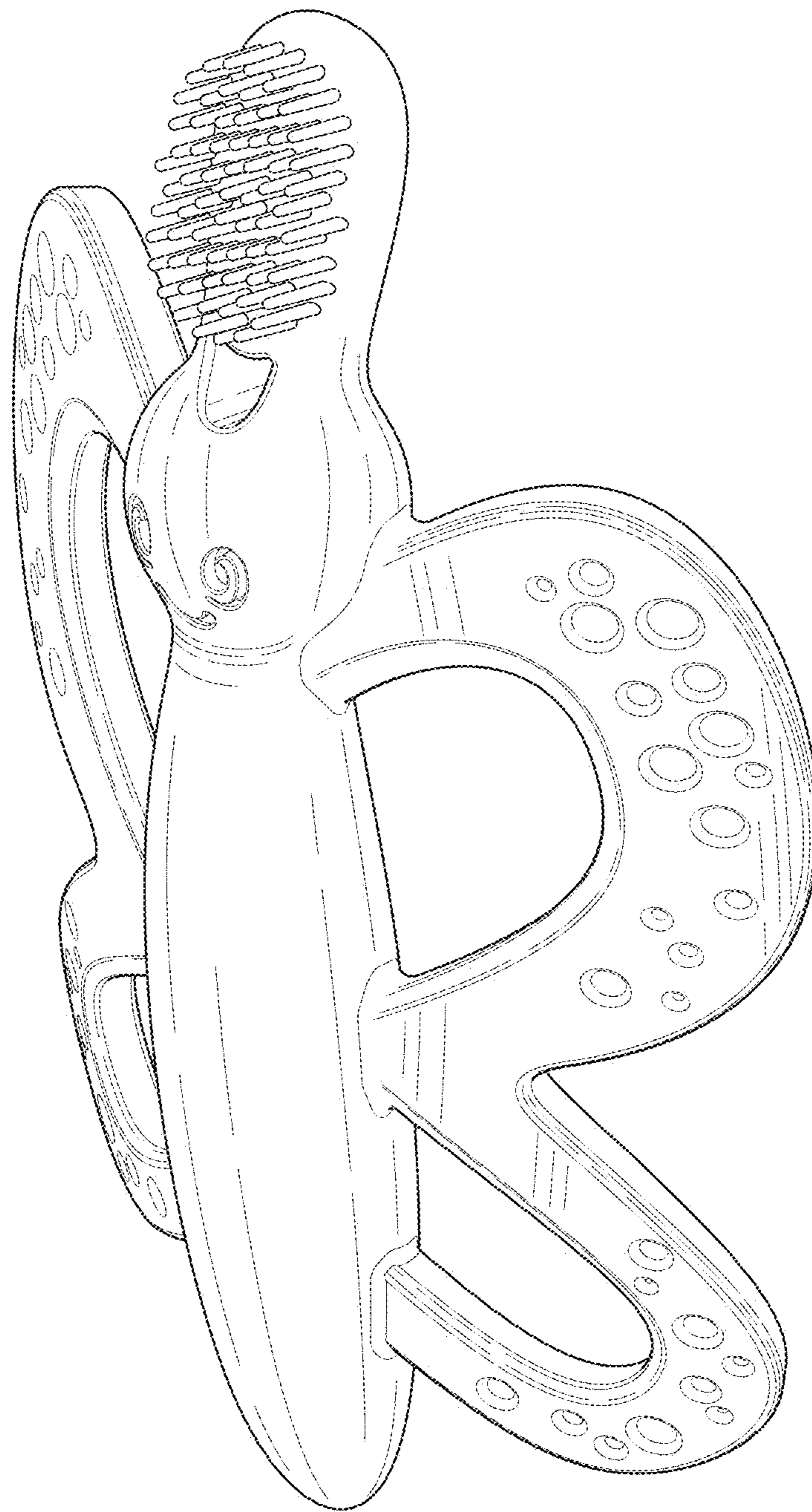

FIG. 1

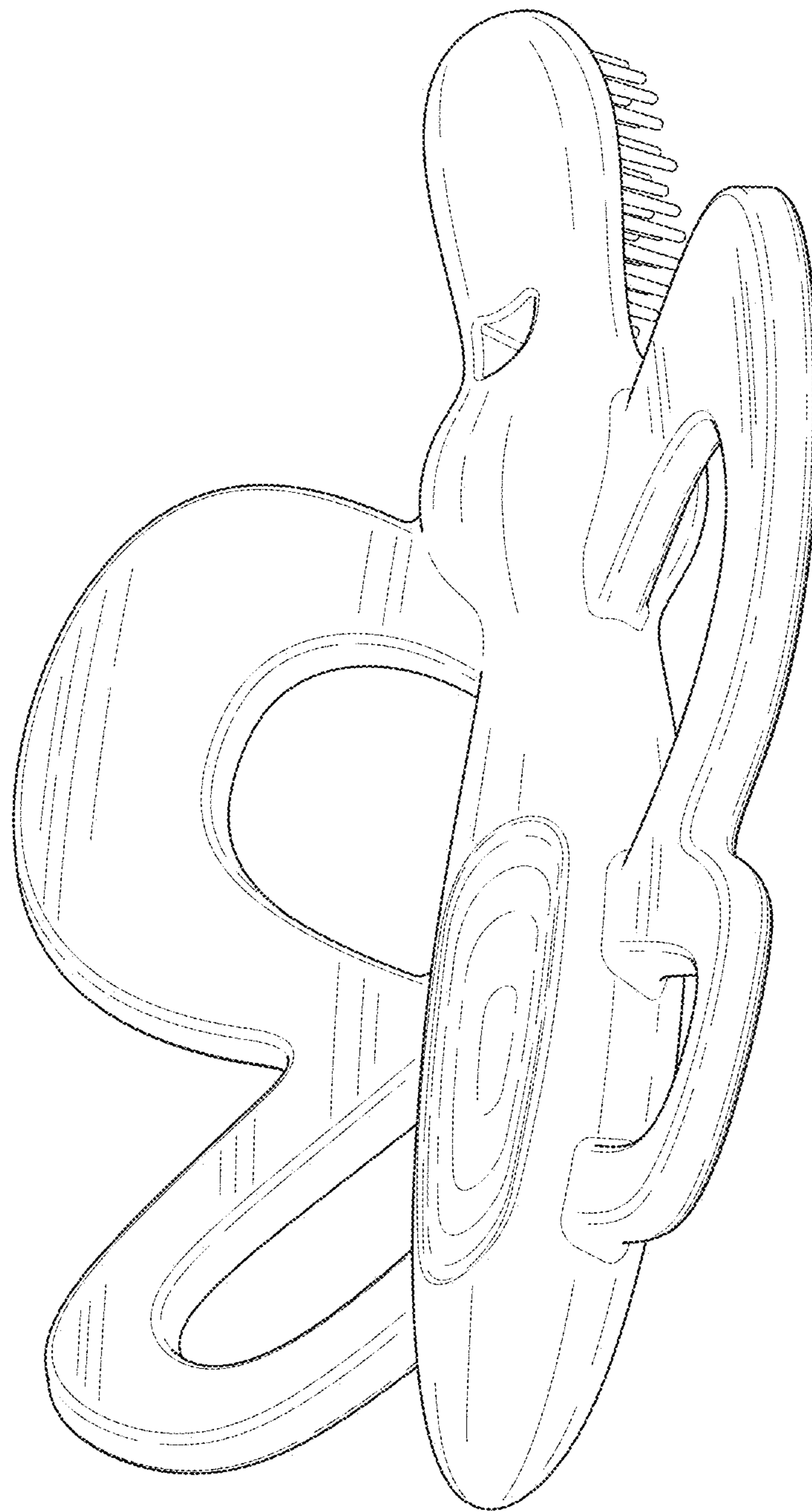

FIG. 2

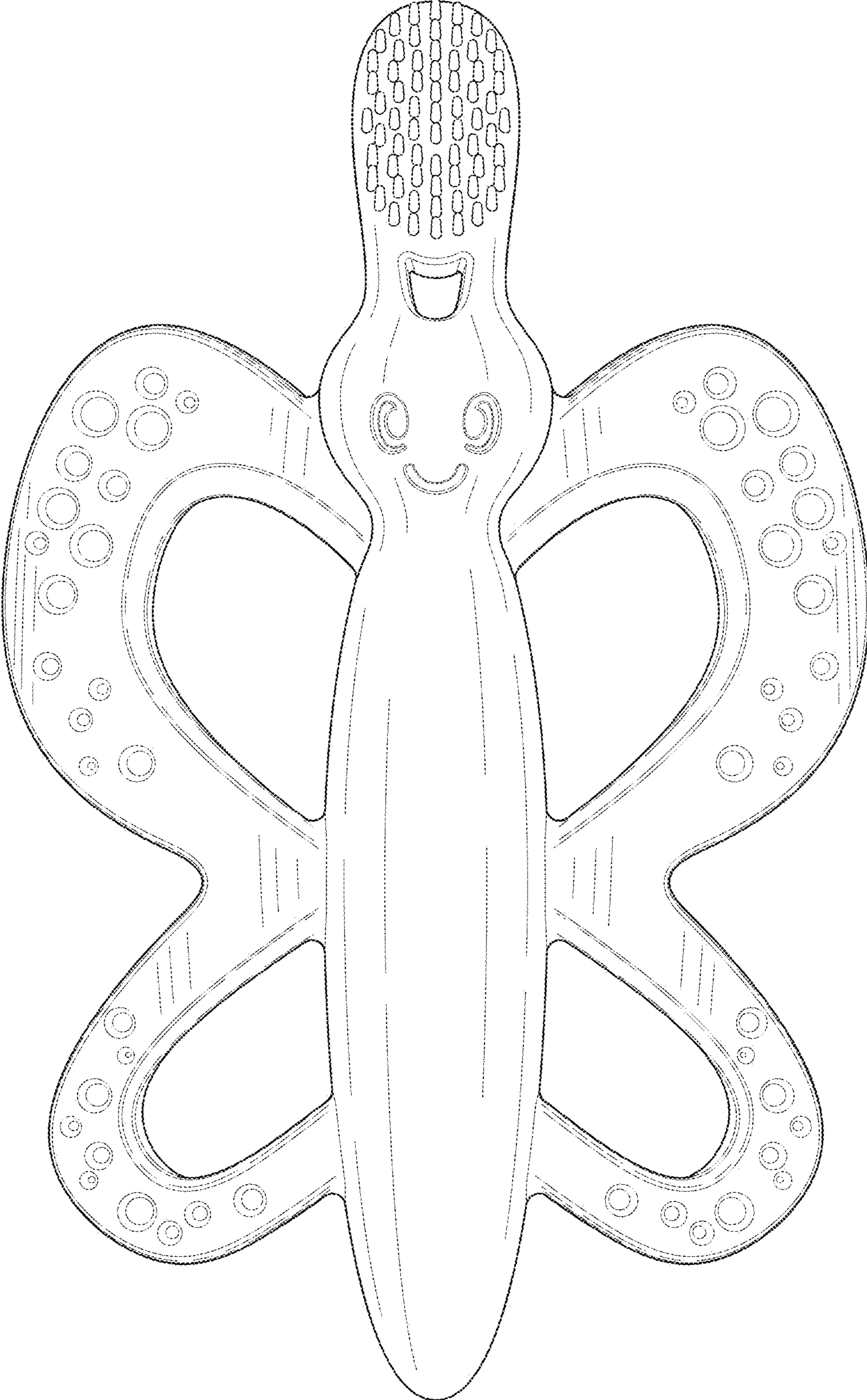

FIG. 3

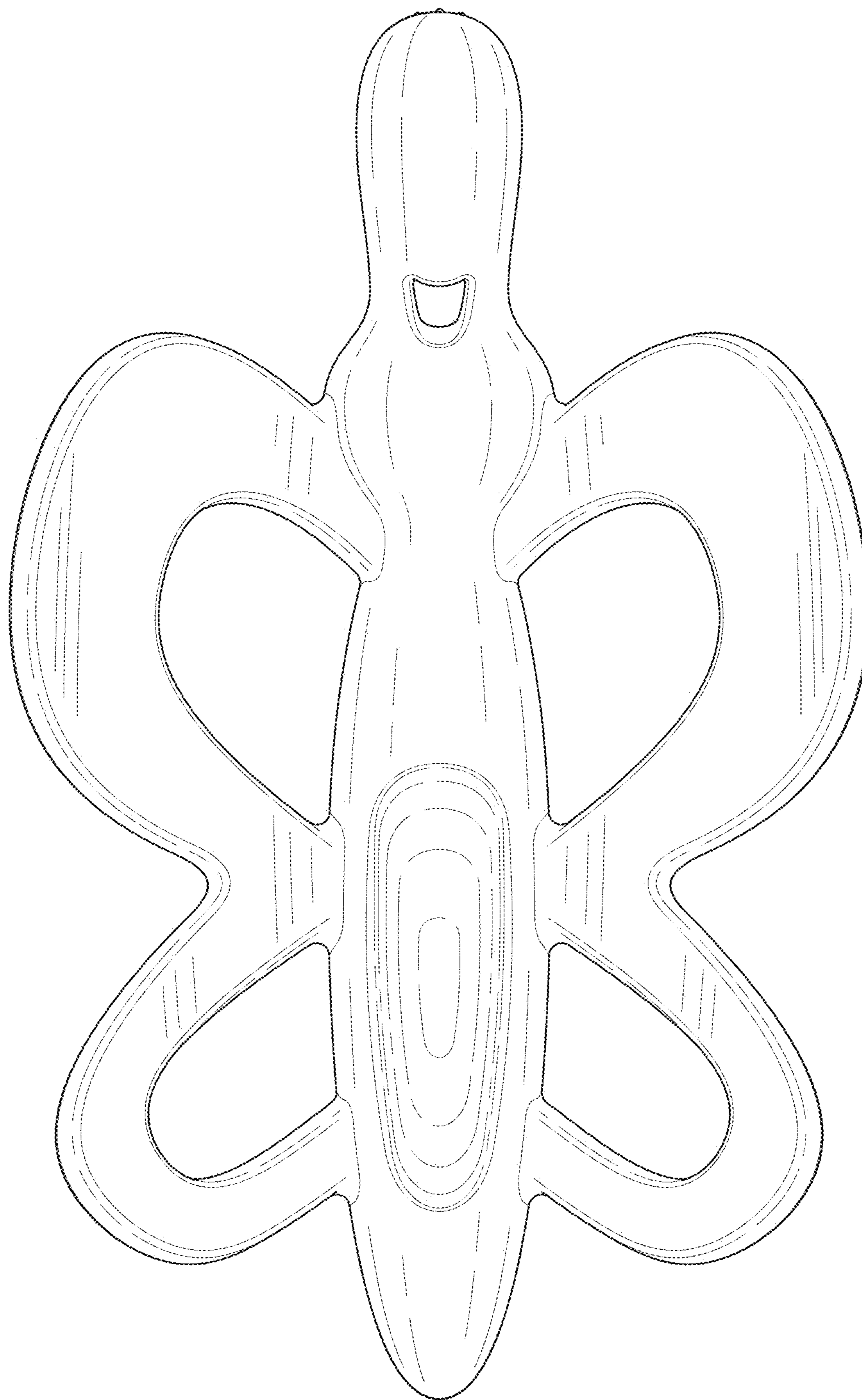

FIG. 4

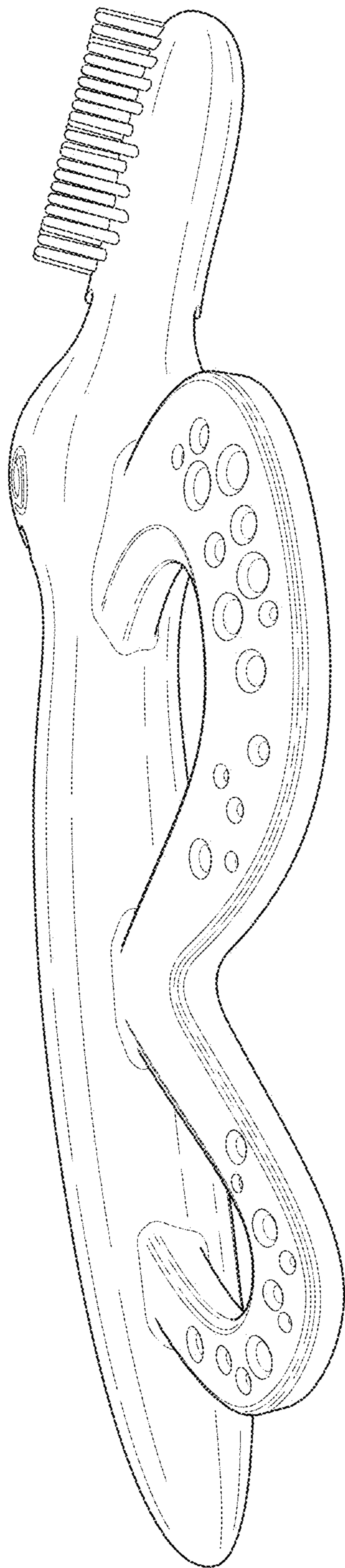

FIG. 5

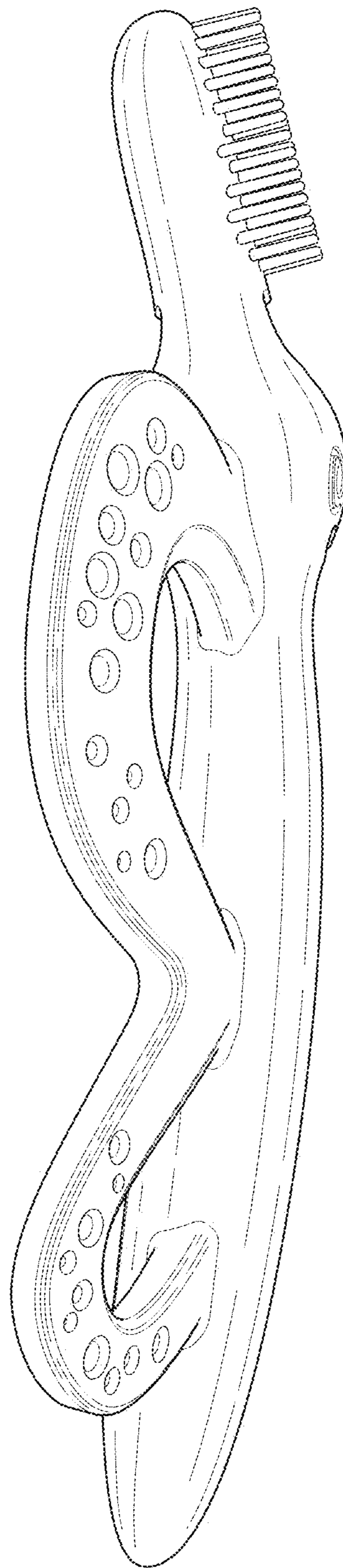

FIG. 6

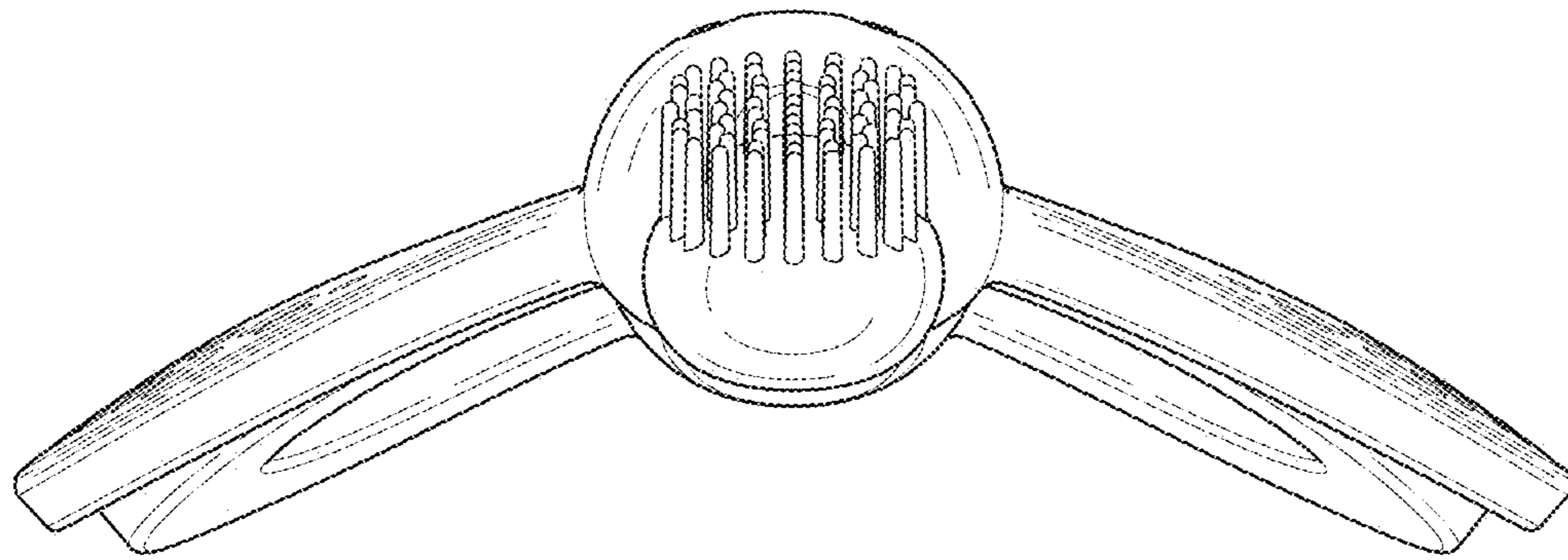

FIG. 7

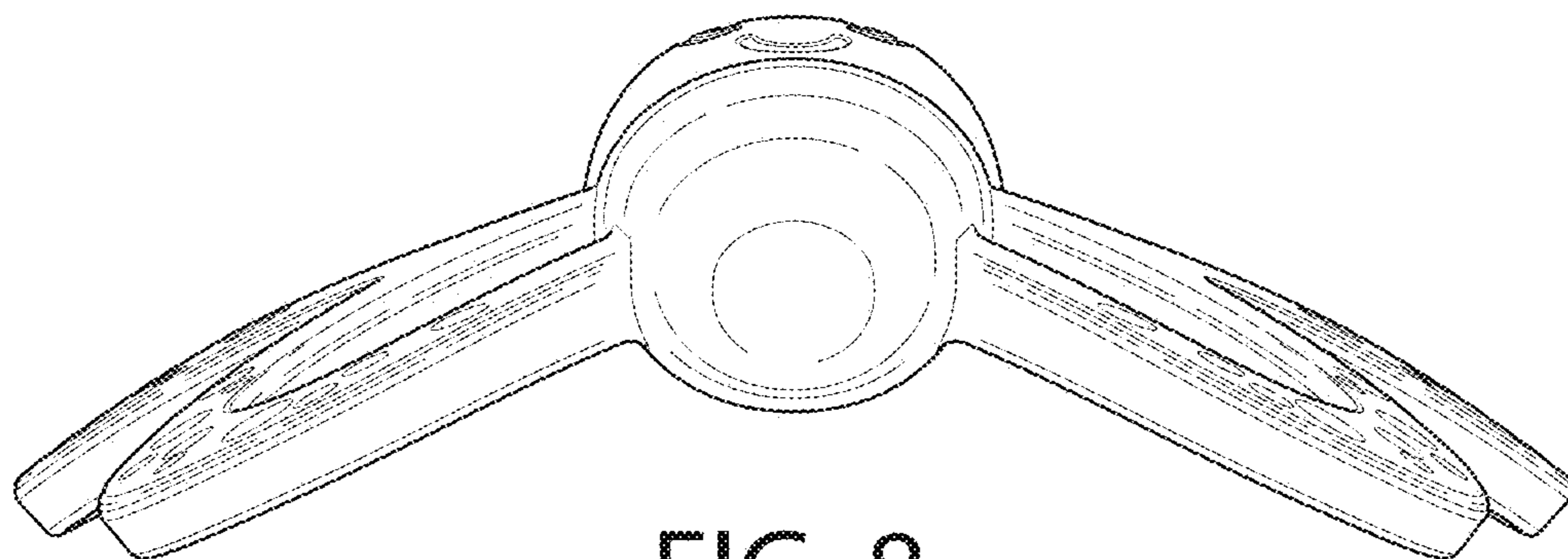

FIG. 8