



US00D871699S

(12) **United States Design Patent**
Jaeger et al.

(10) **Patent No.:** **US D871,699 S**

(45) **Date of Patent:** **** Dec. 31, 2019**

(54) **MAGNETIC QUICK CONNECT**

(71) Applicant: **RainMaker Solutions, Inc.**, El Segundo, CA (US)

(72) Inventors: **Eduard Albert Jaeger**, El Segundo, CA (US); **Robert Gregory Stahl**, Culver City, CA (US); **Jacob Timm Bowles**, El Segundo, CA (US)

(73) Assignee: **Rainmaker Solutions, Inc.**, El Segundo, CA (US)

(**) Term: **15 Years**

(21) Appl. No.: **29/625,767**

(22) Filed: **Nov. 13, 2017**

(51) **LOC (12) Cl.** **15-05**

(52) **U.S. Cl.**
USPC **D32/31**

(58) **Field of Classification Search**
USPC D24/110, 110.3-110.6; D29/122, 103; 128/201.23; 285/9.1
CPC A62B 18/086; A62B 18/04; A62B 18/08; A62B 18/10; A42B 3/0406; A42B 3/283; A42B 3/286; F16L 37/004
See application file for complete search history.

(56) **References Cited**

U.S. PATENT DOCUMENTS

5,318,328 A * 6/1994 Dawson D06F 58/04 285/148.2
5,927,759 A * 7/1999 Hyslop F16L 25/00 239/289

D545,426 S * 6/2007 Church D24/110.3
D590,548 S * 4/2009 Johnson D29/122
7,571,615 B1 * 8/2009 Bikes A42B 3/285 62/259.3
7,814,903 B2 * 10/2010 Osborne B64D 10/00 128/200.24
D668,758 S * 10/2012 Hall D24/110.2
8,936,022 B2 * 1/2015 Walker A62B 17/04 128/201.23
D731,123 S * 6/2015 Spear D29/122
D746,439 S * 12/2015 Steindorf D24/110.6
9,492,691 B2 * 11/2016 Rosert A62B 18/10
9,999,546 B2 * 6/2018 Gardner A61F 9/068
10,137,320 B2 * 11/2018 Walker A62B 17/04

* cited by examiner

Primary Examiner — Ruth McInroy

(74) *Attorney, Agent, or Firm* — Hackler Daghighian Martino & Novak

(57) **CLAIM**

We claim the ornamental design for a magnetic quick connect, as shown and described.

DESCRIPTION

FIG. 1 is a front view of a magnetic quick connect showing our new design;
FIG. 2 is a front, right-side perspective view thereof;
FIG. 3 is a front view thereof;
FIG. 4 is a back view thereof;
FIG. 5 is top view thereof; and,
FIG. 6 is a bottom view thereof.
The broken lines in FIGS. 1-6 are for illustrative purposes only and form no part of the claimed design.

1 Claim, 4 Drawing Sheets

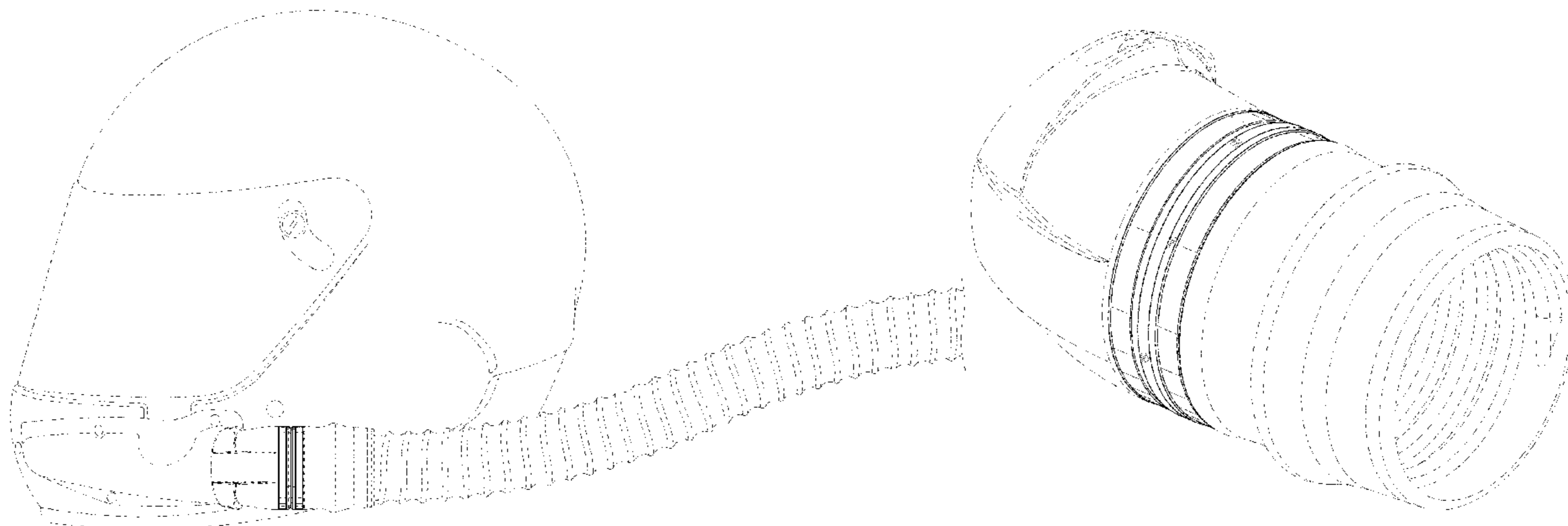

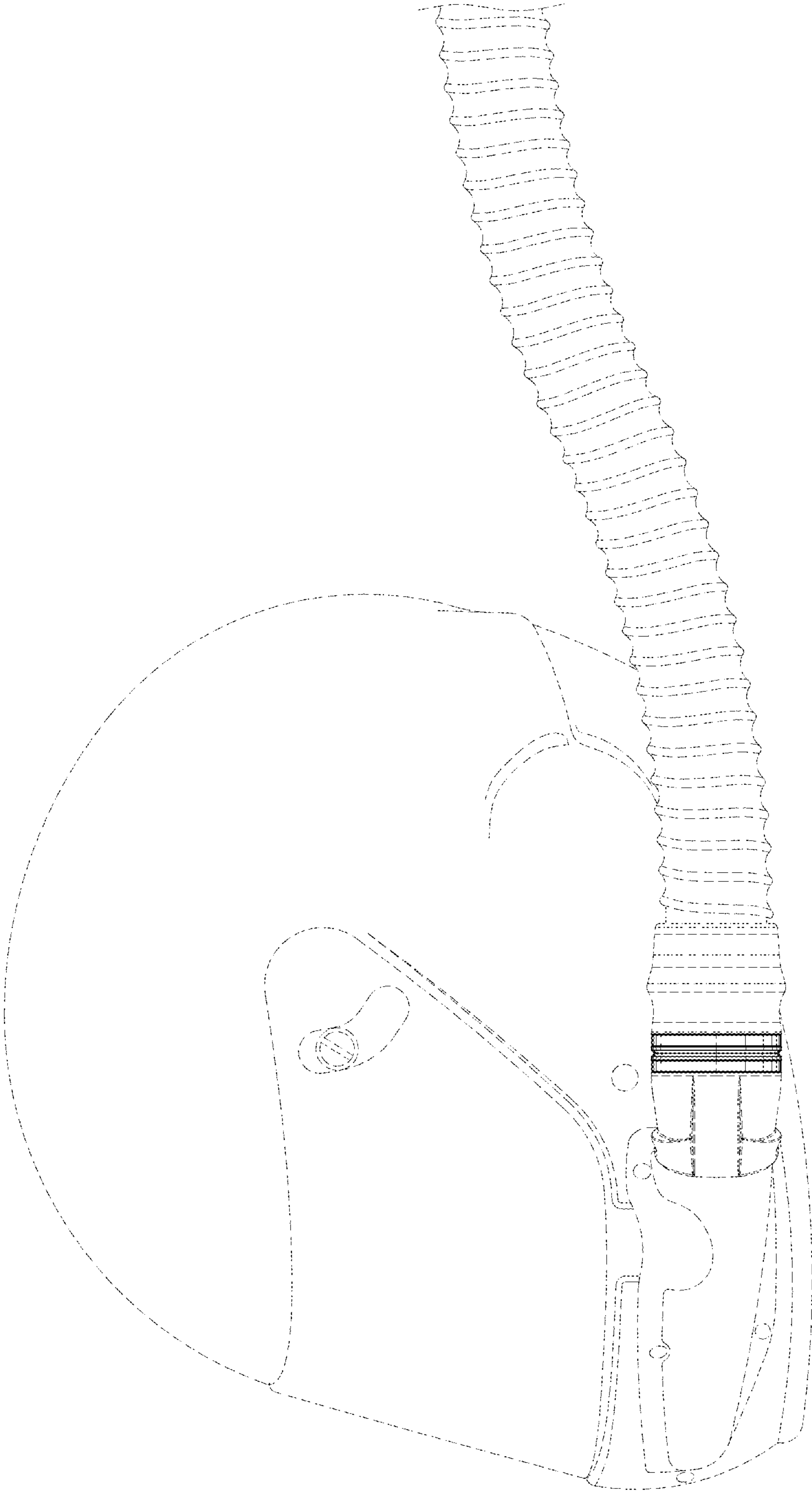

FIG. 1

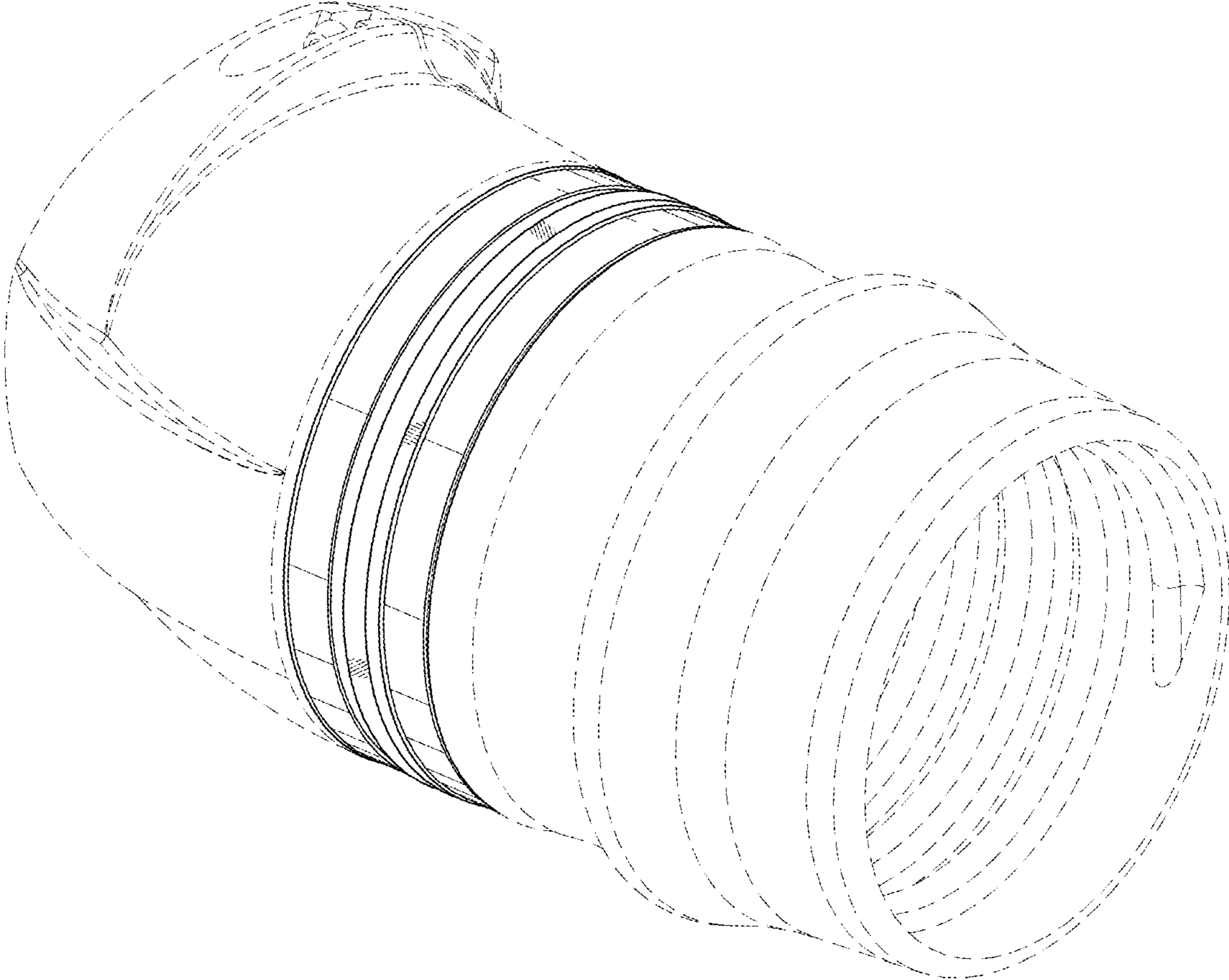

FIG. 2

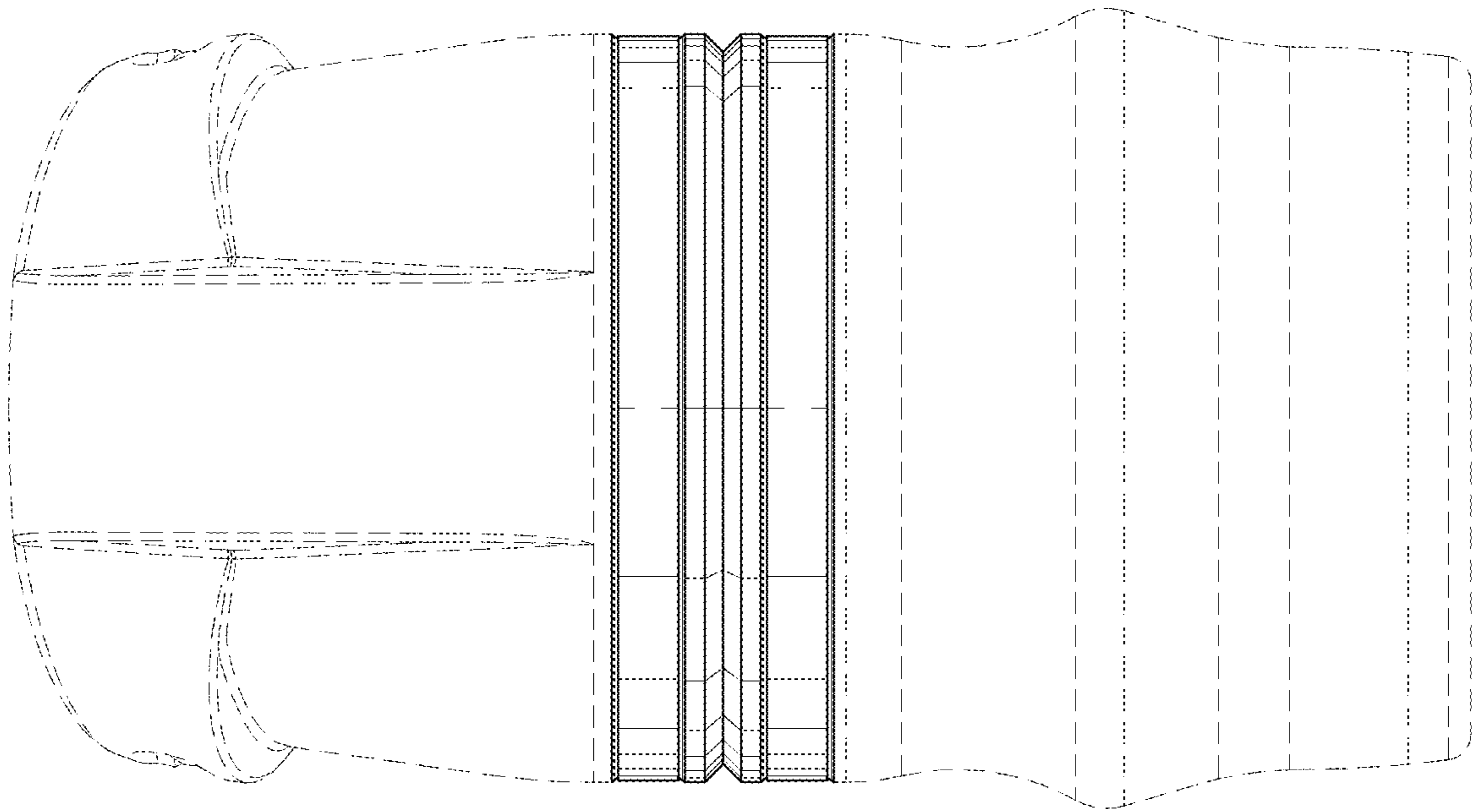

FIG. 3

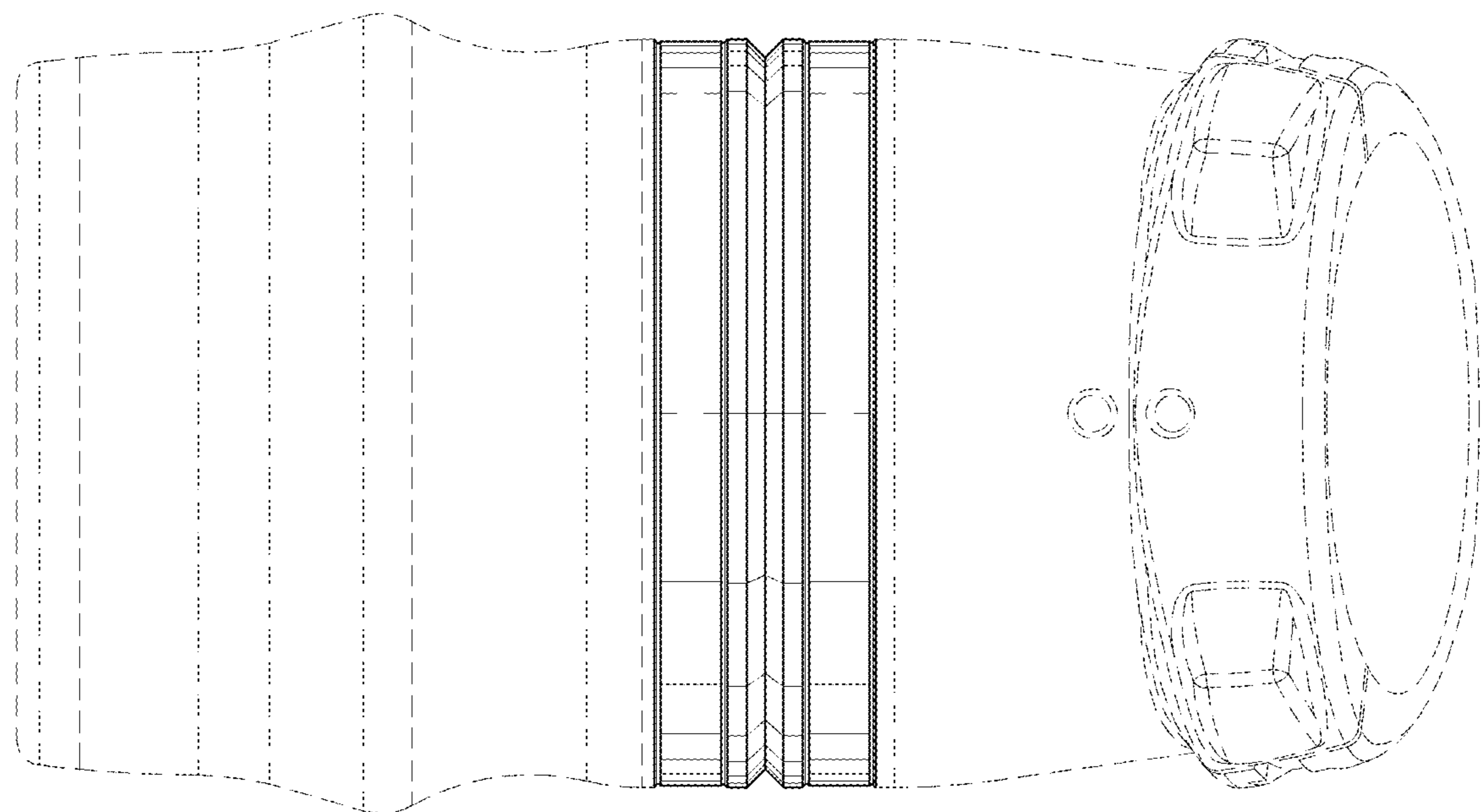

FIG. 4

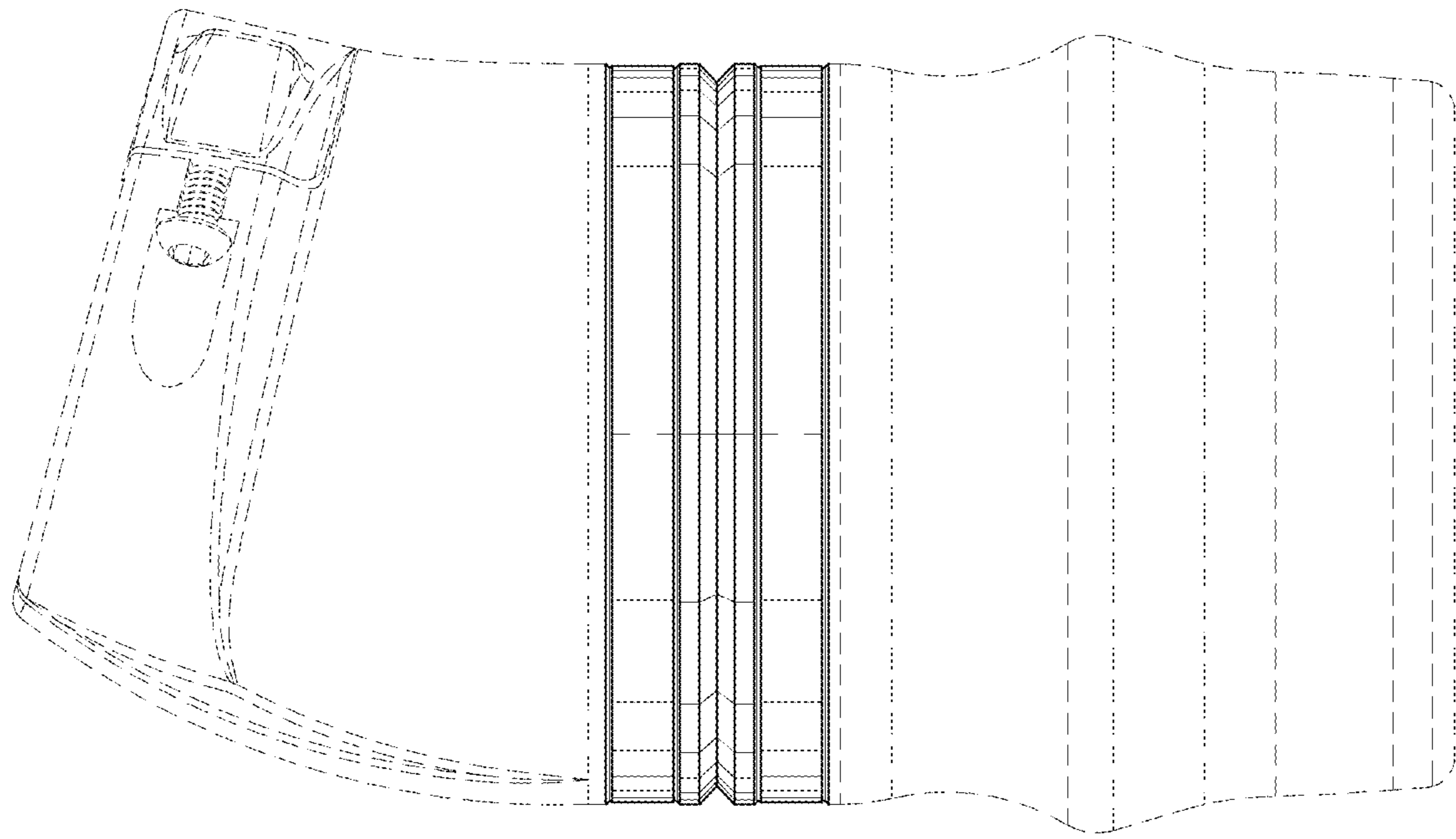

FIG. 5

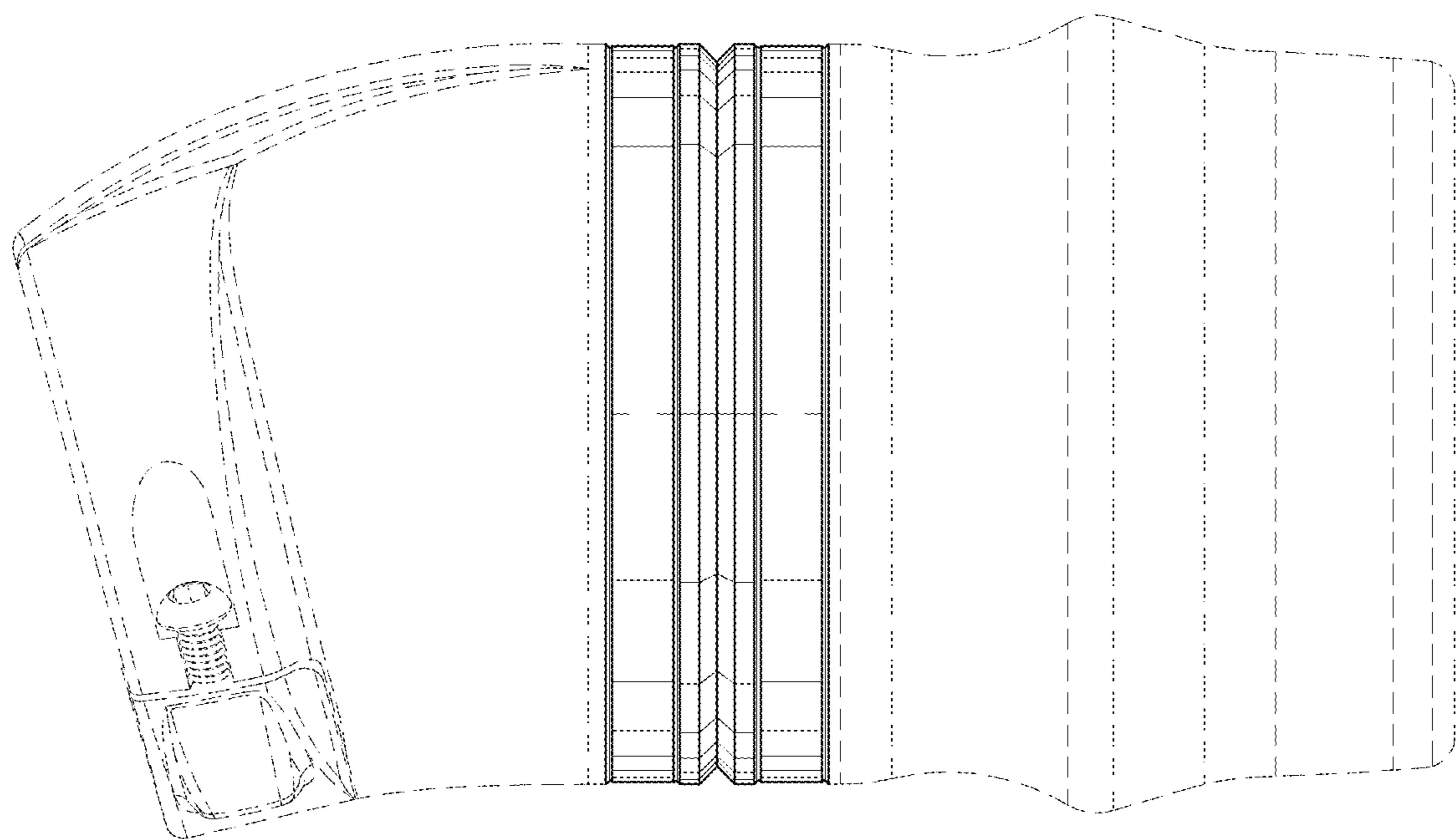

FIG. 6