



US00D871698S

(12) **United States Design Patent**  
**Bowles et al.**

(10) **Patent No.:** **US D871,698 S**  
(45) **Date of Patent:** **\*\* Dec. 31, 2019**

(54) **MAGNETIC QUICK CONNECT FOR USE WITH FORCED AIR HEADGEAR**

(71) Applicant: **RainMaker Solutions, Inc.**, El Segundo, CA (US)

(72) Inventors: **Jacob Timm Bowles**, El Segundo, CA (US); **Robert Gregory Stahl**, Culver City, CA (US); **Eduard Albert Jaeger**, El Segundo, CA (US)

(73) Assignee: **RainMaker Solutions, Inc.**, El Segundo, CA (US)

(\*\*) Term: **15 Years**

(21) Appl. No.: **29/625,752**

(22) Filed: **Nov. 13, 2017**

(51) **LOC (12) Cl.** ..... **15-05**

(52) **U.S. Cl.**  
USPC ..... **D32/31**

(58) **Field of Classification Search**  
USPC ..... D24/110, 110.3-110.6; D29/122, 103; 128/201.23; 285/9.1  
CPC ..... A62B 18/086; A62B 18/04; A62B 18/08; A62B 18/10; A42B 3/0406; A42B 3/283; A42B 3/286; F16L 37/004  
See application file for complete search history.

(56) **References Cited**

U.S. PATENT DOCUMENTS

- 5,318,328 A \* 6/1994 Dawson ..... D06F 58/04 285/148.2
- 5,927,759 A \* 7/1999 Hyslop ..... F16L 25/00 239/289

- D545,426 S \* 6/2007 Church ..... D24/110.3
- D590,548 S \* 4/2009 Johnson ..... D29/122
- 7,571,615 B1 \* 8/2009 Bikes ..... A42B 3/285 62/259.3
- 7,814,903 B2 \* 10/2010 Osborne ..... B64D 10/00 128/200.24
- D668,758 S \* 10/2012 Hall ..... D24/110.2
- 8,936,022 B2 \* 1/2015 Walker ..... A62B 17/04 128/201.23
- D731,123 S \* 6/2015 Spear ..... D29/122
- D746,439 S \* 12/2015 Steindorf ..... D24/110.6
- 9,492,691 B2 \* 11/2016 Rosert ..... A62B 18/10
- 9,999,546 B2 \* 6/2018 Gardner ..... A61F 9/068
- 10,137,320 B2 \* 11/2018 Walker ..... A62B 17/04

\* cited by examiner

*Primary Examiner* — Ruth McInroy

(74) *Attorney, Agent, or Firm* — Hackler Daghighian Martino & Novak

(57) **CLAIM**

The ornamental design for a magnetic quick connect for use with forced air headgear, as shown and described.

**DESCRIPTION**

FIG. 1 is a front view of a magnetic quick connect for use with forced air headgear showing our new design; FIG. 2 is a front, right-side perspective view thereof; FIG. 3 is a front view thereof; FIG. 4 is a back view thereof; FIG. 5 is top view thereof; FIG. 6 is a bottom view thereof; FIG. 7 is a right-side view thereof; and, FIG. 8 is a left-side view thereof. The broken lines in FIGS. 1-8 are for illustrative purposes only and form no part of the claimed design.

**1 Claim, 5 Drawing Sheets**

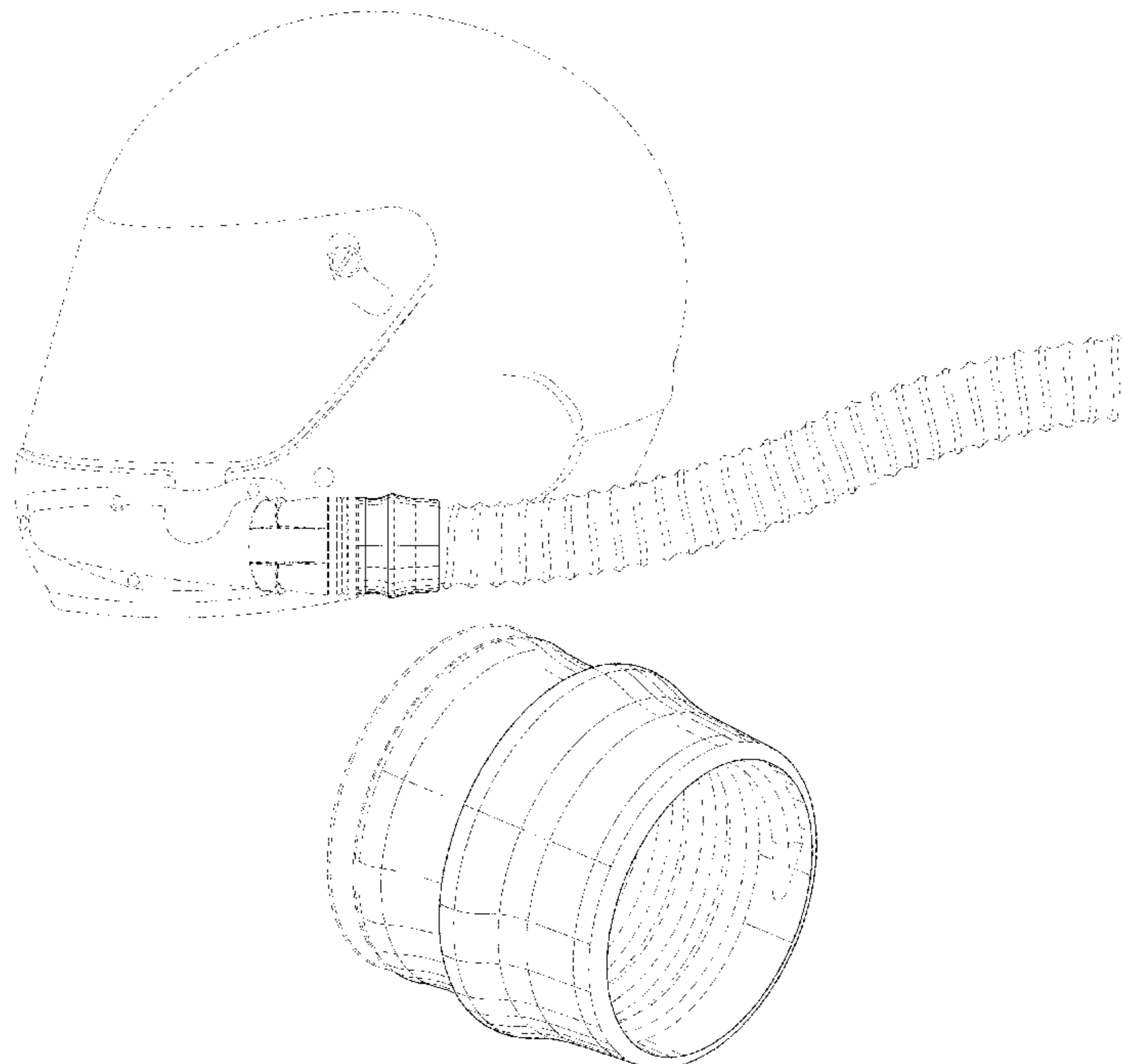

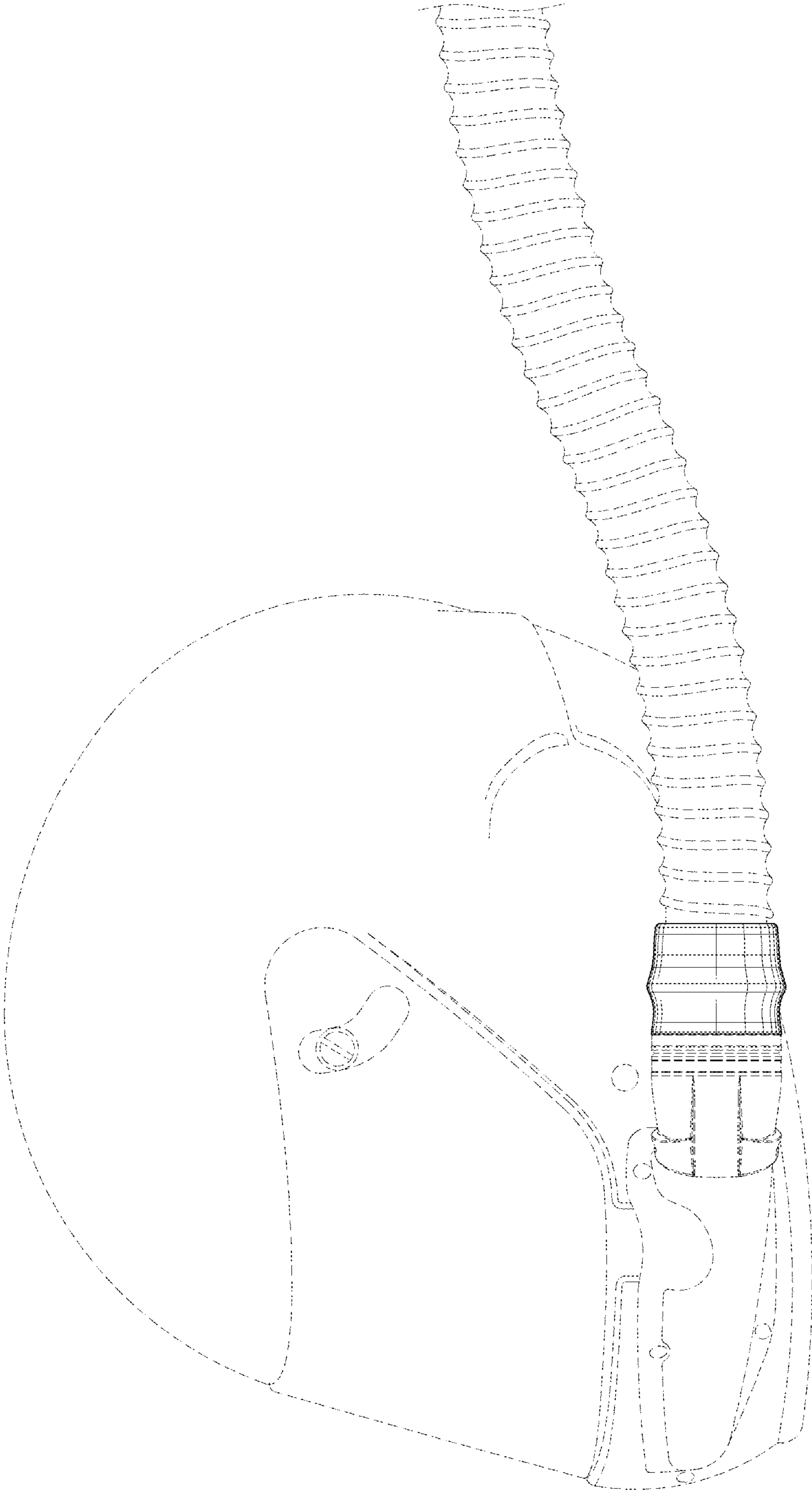
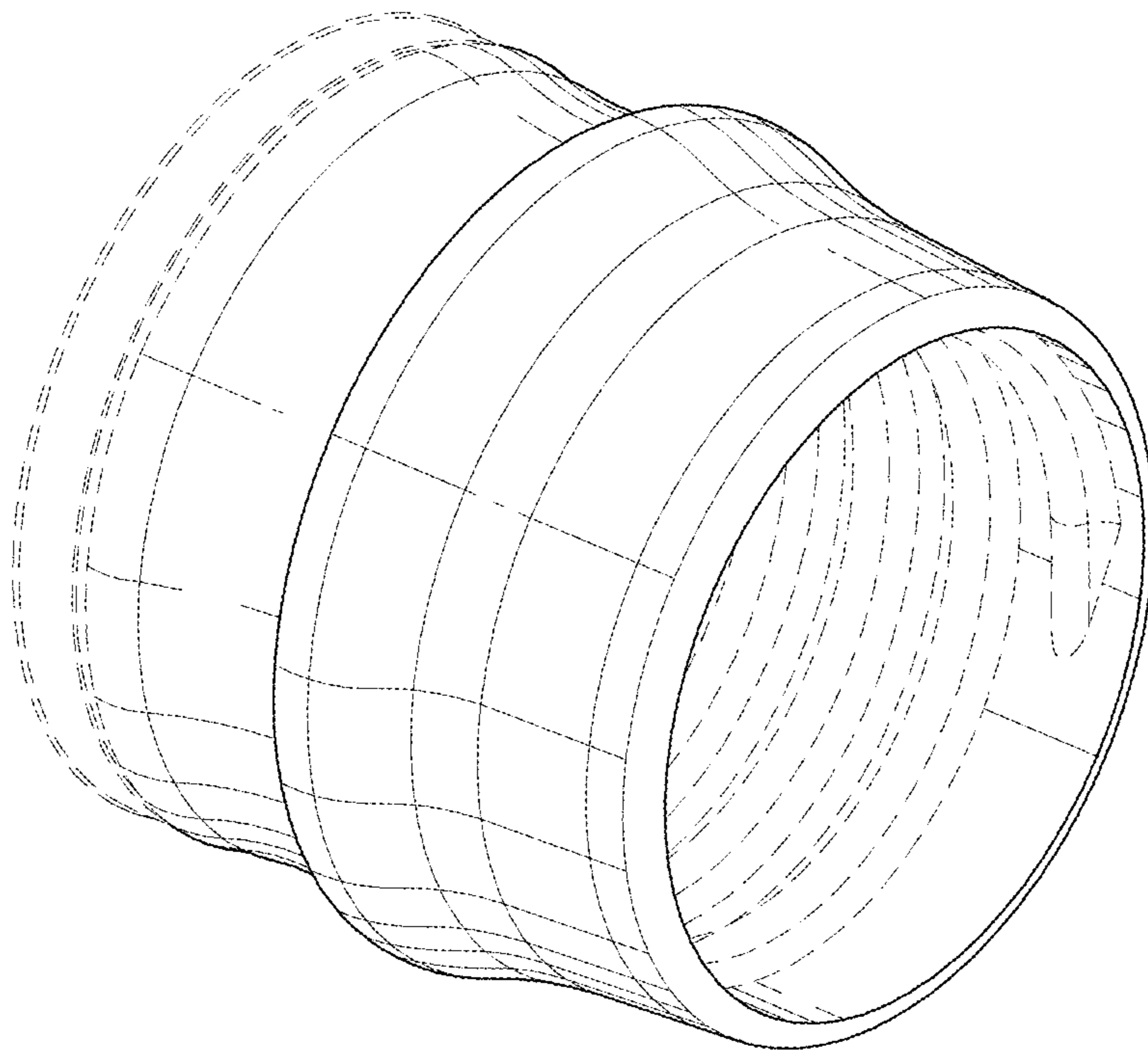
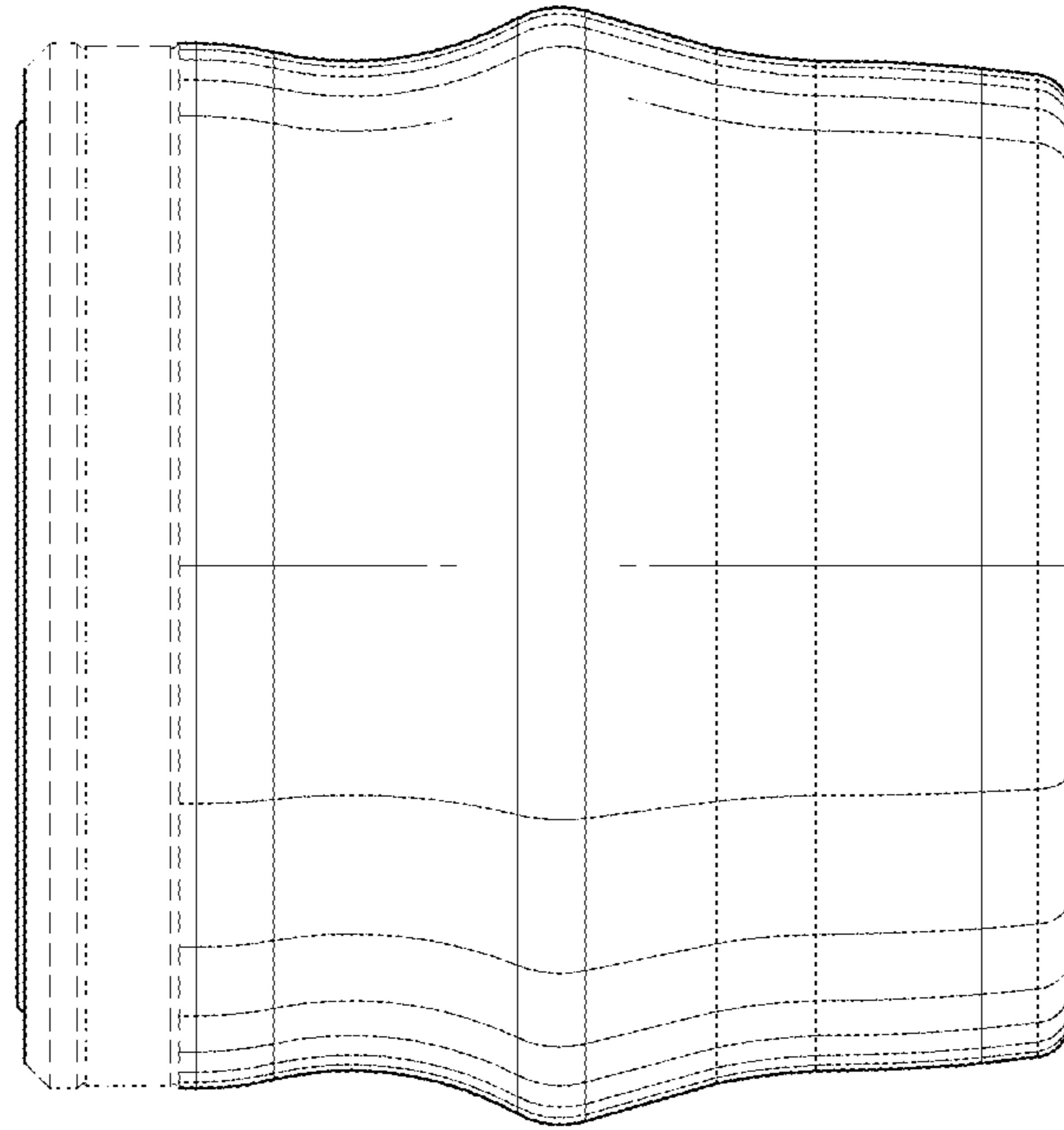

FIG. 1



**FIG. 2**



**FIG. 3**

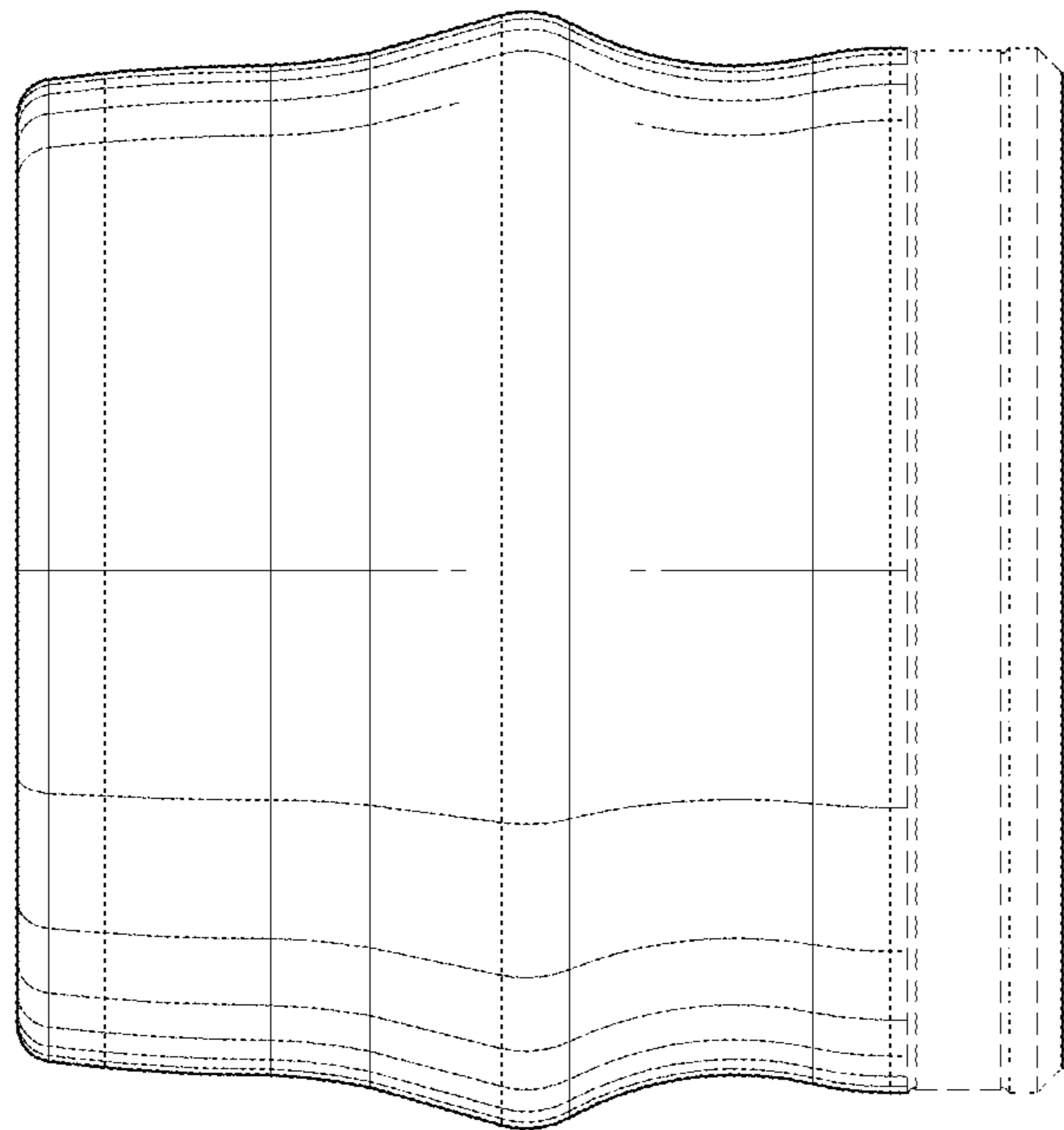

**FIG. 4**

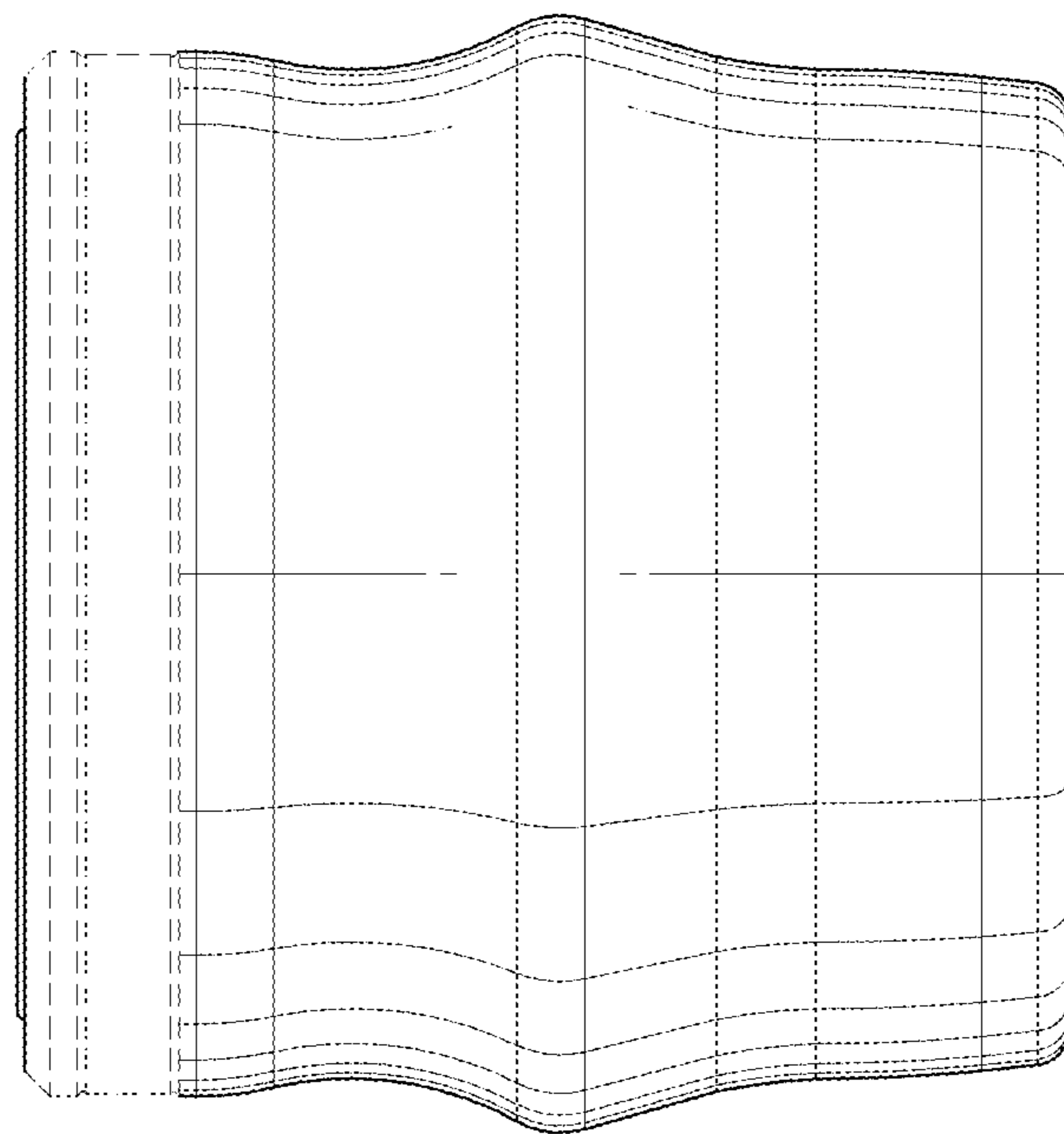

**FIG. 5**

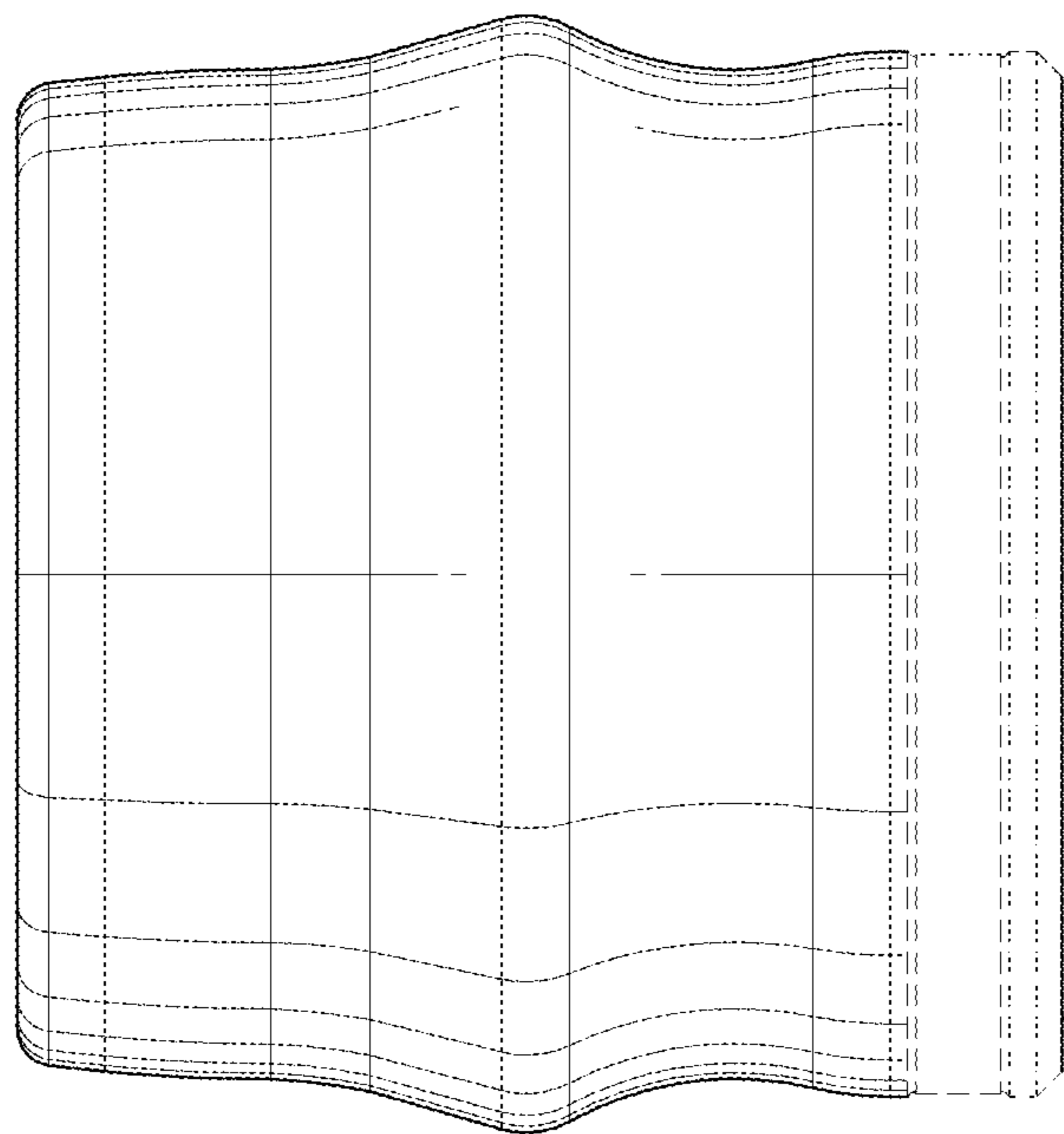

**FIG. 6**

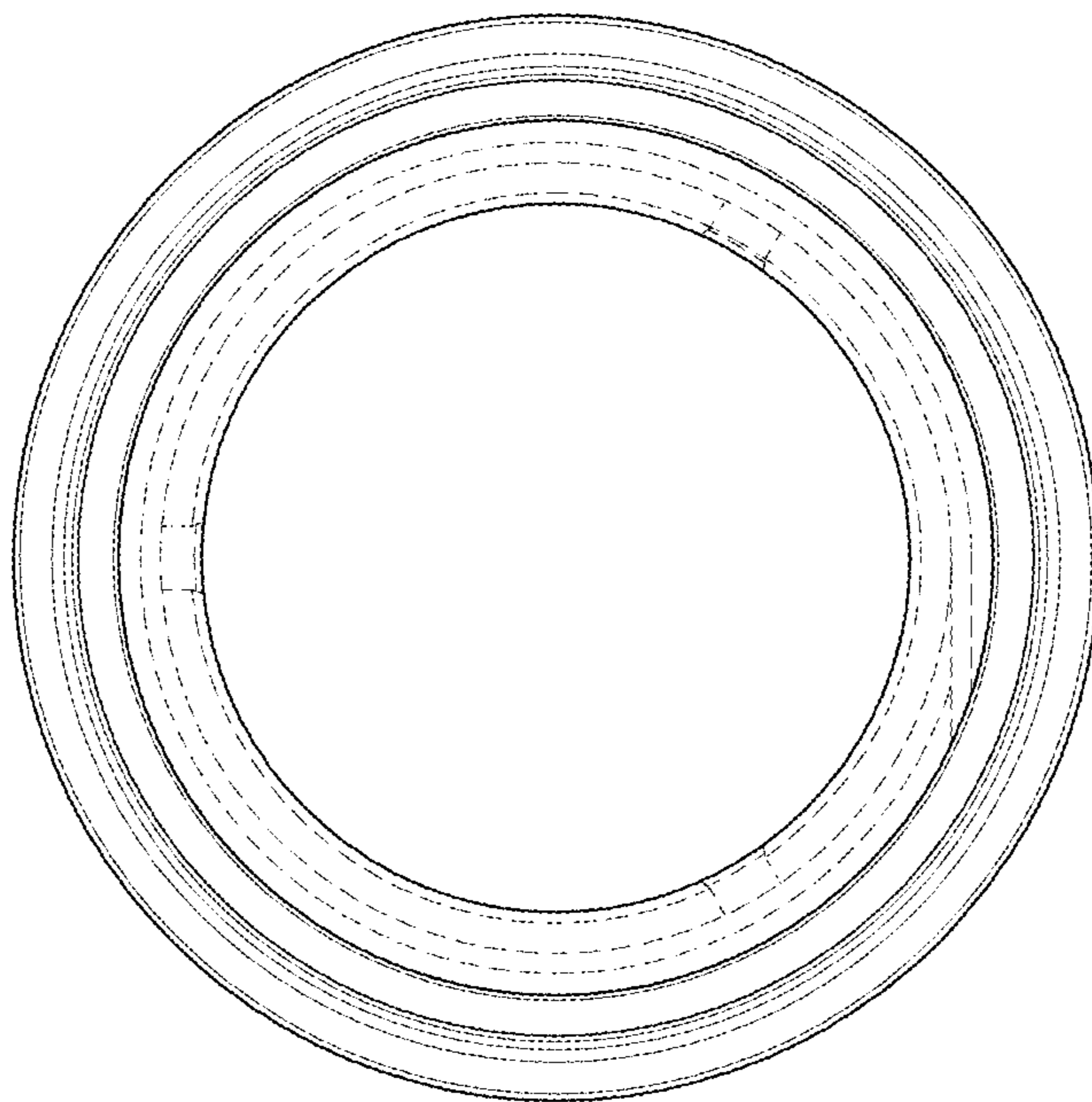

**FIG. 7**

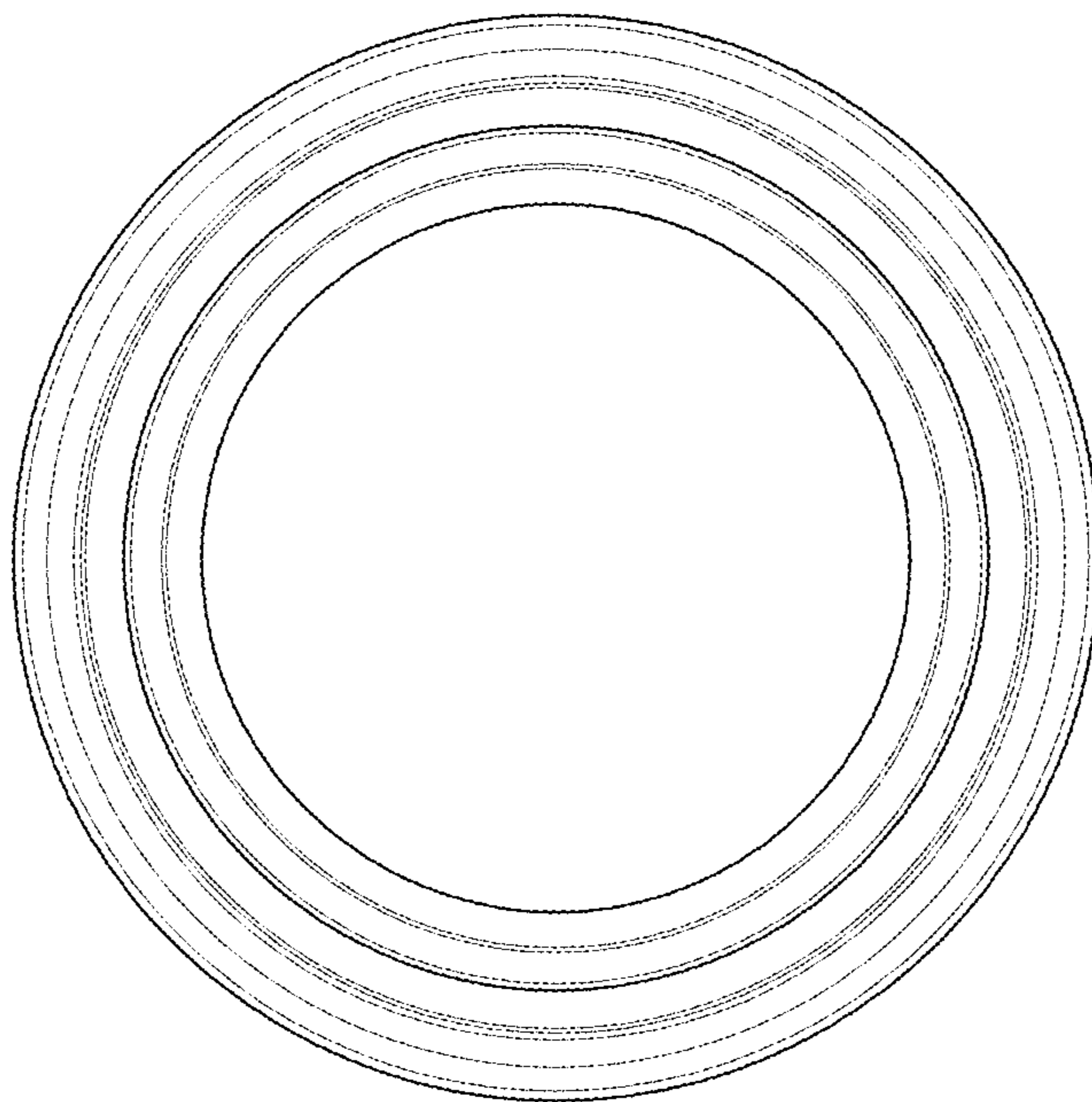

**FIG. 8**