



US00D871690S

(12) **United States Design Patent** (10) **Patent No.:** **US D871,690 S**
Lee et al. (45) **Date of Patent:** **** Dec. 31, 2019**

- (54) **WASHING MACHINE**
- (71) Applicant: **Samsung Electronics Co., Ltd.**,
Suwon-si (KR)
- (72) Inventors: **Dae-Kyun Lee**, Suwon-si (KR);
Hwa-Yong Shin, Anyang-si (KR)
- (73) Assignee: **Samsung Electronics Co., Ltd.**,
Suwon-si (KR)
- (**) Term: **15 Years**
- (21) Appl. No.: **29/691,913**
- (22) Filed: **May 21, 2019**

Related U.S. Application Data

- (62) Division of application No. 29/628,265, filed on Dec. 4, 2017.

(30) **Foreign Application Priority Data**

- Jun. 2, 2017 (KR) 30-2017-0025202
- Jun. 2, 2017 (KR) 30-2017-0025204
- Jun. 2, 2017 (KR) 30-2017-0025207
- Jun. 2, 2017 (KR) 30-2017-0025217
- Jun. 2, 2017 (KR) 30-2017-0025218

- (51) **LOC (12) Cl.** **15-05**

- (52) **U.S. Cl.**
USPC **D32/6**

- (58) **Field of Classification Search**
USPC D32/1, 5, 6, 25, 28, 29
CPC D06F 33/02; D06F 2204/065; D06F 25/00;
D06F 35/006; D06F 37/28; D06F 39/14;
D06F 58/203
See application file for complete search history.

(56) **References Cited**

U.S. PATENT DOCUMENTS

- D521,197 S * 5/2006 Kim D32/8
- D583,114 S * 12/2008 Jeon D32/8

- D642,753 S * 8/2011 Ha D32/6
- D648,907 S * 11/2011 Jeon D32/6
- D649,722 S * 11/2011 Chung D32/6
- D651,778 S * 1/2012 Miller D32/25
- D653,006 S * 1/2012 Takahashi D32/6
- D658,340 S * 4/2012 Jeon D32/6
- D680,281 S * 4/2013 Qin D32/6

(Continued)

OTHER PUBLICATIONS

Steam Washer posted by LG posted date Jul. 3, 2014, © Amazon, [online], [site visited Aug. 15, 2019]. Available from Internet, <https://www.amazon.com/LG-WM3997HWA-Combination-TrueBalance-Anti-Vibration> (Year: 2014).*

(Continued)

Primary Examiner — Cynthia Ramirez

Assistant Examiner — Laura H Yu

(74) *Attorney, Agent, or Firm* — NSIP Law

(57) **CLAIM**

We claim the ornamental design for a washing machine, as shown and described.

DESCRIPTION

FIG. 1 is a front perspective view of a washing machine showing our new design; FIG. 2 is a front elevational view thereof; FIG. 3 is a rear elevational view thereof; FIG. 4 is a left-side elevational view thereof; FIG. 5 is a right-side elevational view thereof; FIG. 6 is a top plan view thereof; and, FIG. 7 is a bottom plan view thereof. The evenly spaced broken lines illustrating portions of the washing machine are for environmental purposes only and form no part of the claimed design. The uneven dot-dash broken lines in the figures represent a boundary line and form no part of the claimed design.

1 Claim, 7 Drawing Sheets

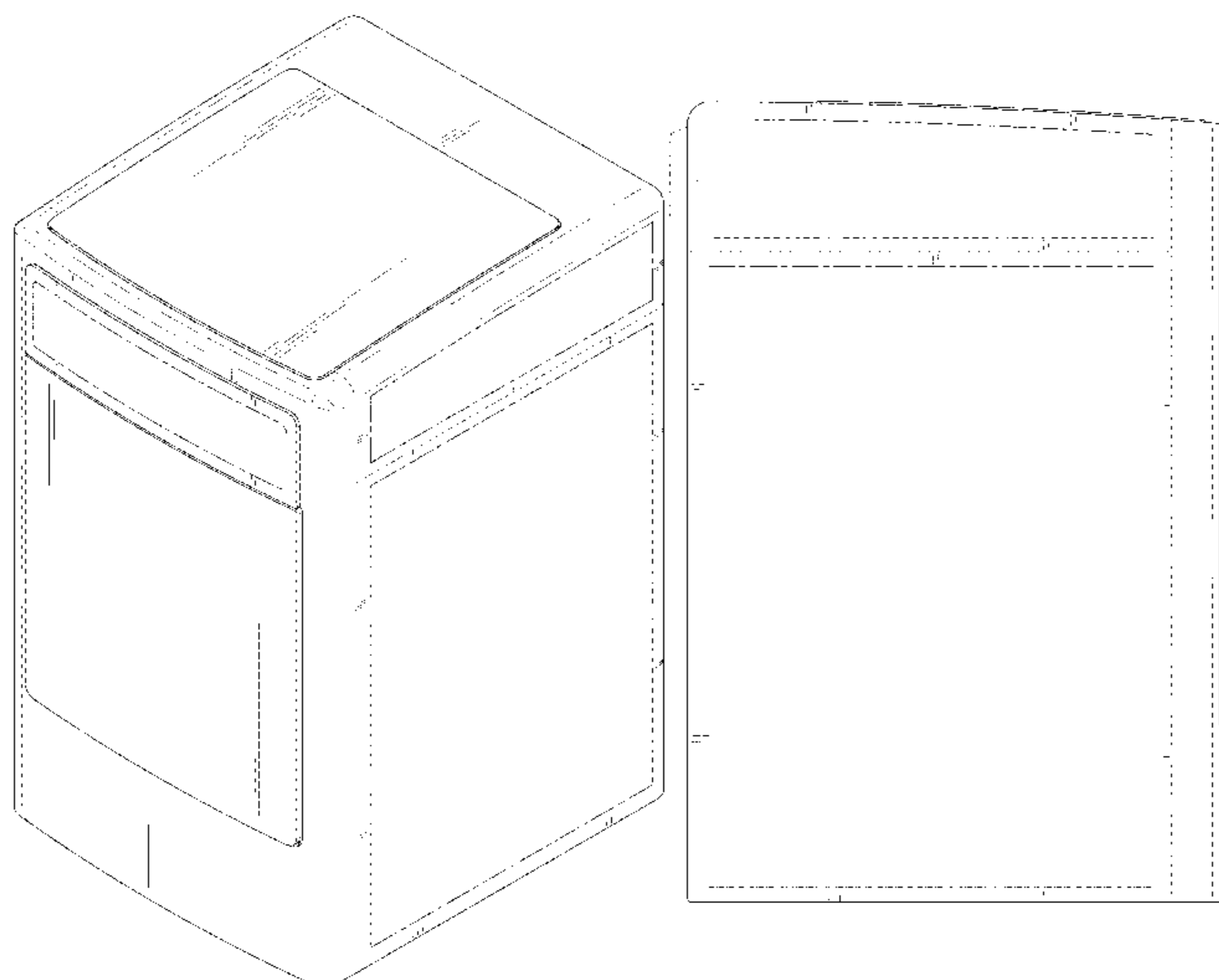

(56)

References Cited

U.S. PATENT DOCUMENTS

D700,410	S *	2/2014	Hwang	D32/25
D739,096	S *	9/2015	Qin	D32/6
D739,097	S *	9/2015	Qin	D32/6
D772,507	S *	11/2016	Bixby	D32/25
D774,715	S *	12/2016	Kim	D32/6
D774,716	S *	12/2016	Kim	D32/6
D780,386	S *	2/2017	Lee	D32/6
D824,123	S	7/2018	Yoon et al.		
D825,867	S	8/2018	Yoon et al.		
D826,489	S	8/2018	Yoon et al.		
D827,226	S *	8/2018	Chung	D32/6
D835,865	S	12/2018	Lee et al.		
D839,504	S	1/2019	Ha et al.		
D839,506	S	1/2019	Ha et al.		
D841,908	S *	2/2019	Ayers	D32/25
D848,092	S	5/2019	Yoon et al.		
D850,034	S *	5/2019	Yoon	D32/6
2015/0145388	A1 *	5/2015	Jung, II	D06F 37/267 312/228
2017/0191201	A1 *	7/2017	Ku	D06F 25/00
2017/0233927	A1 *	8/2017	Lee	D06F 37/04 68/17 R

OTHER PUBLICATIONS

Flex Wash posted by Samsung posted date Sep. 18, 2017, © Amazon, [online], [site visited Aug. 15, 2019]. Available from Internet, <https://www.amazon.com/Samsung-Total-White-FlexWash-Washer> (Year: 2017).*

* cited by examiner

FIG. 1

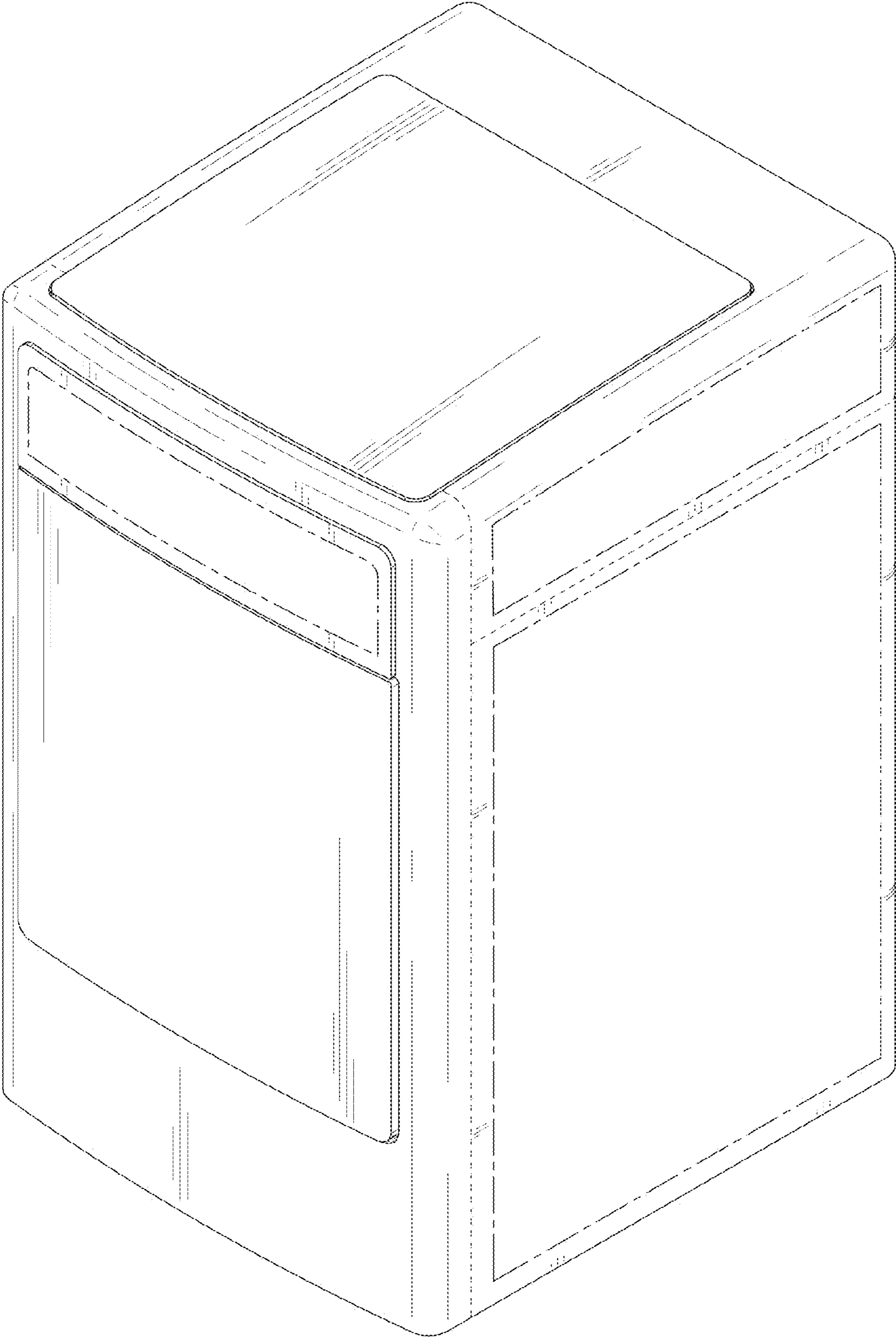

FIG. 2

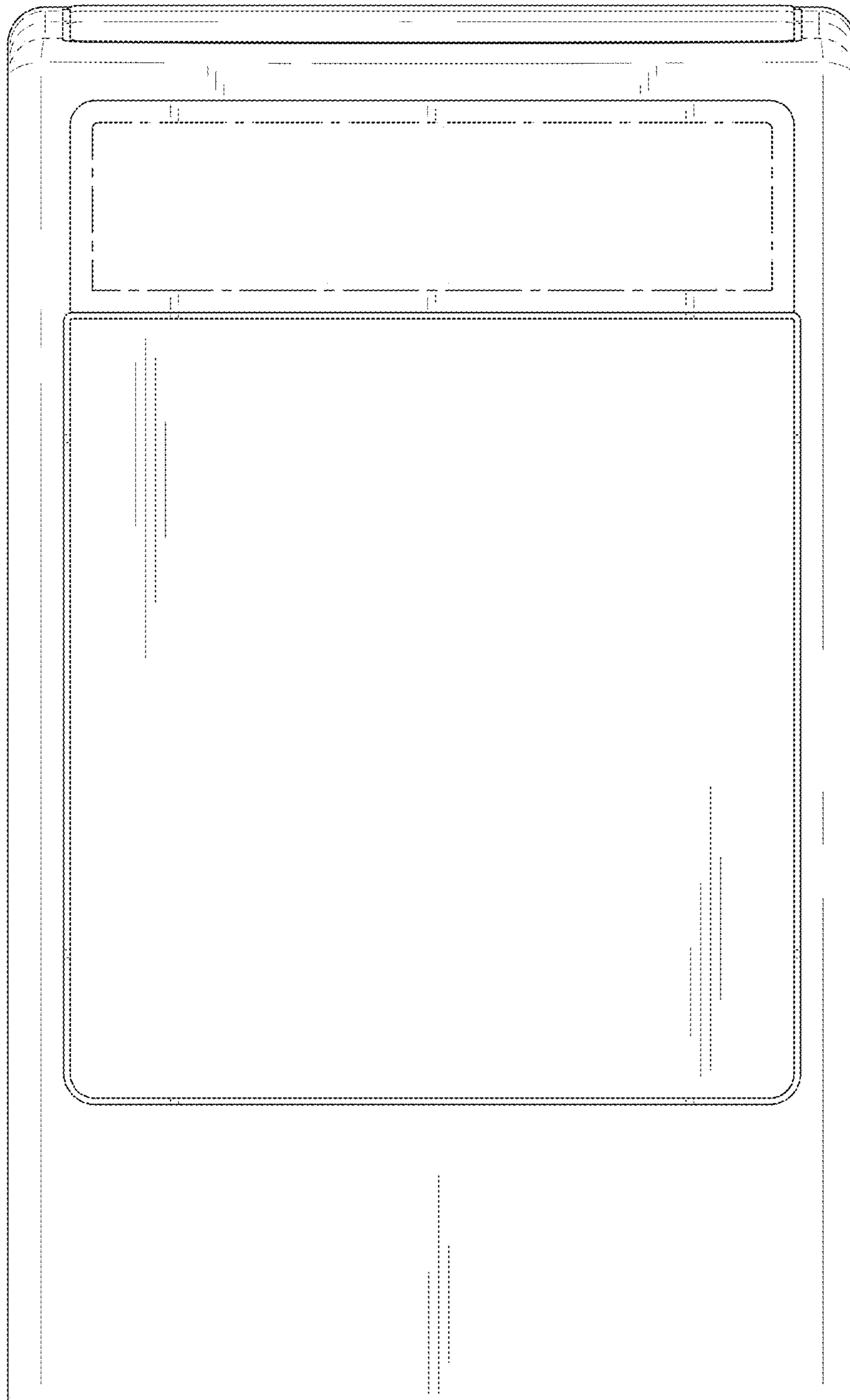

FIG. 3

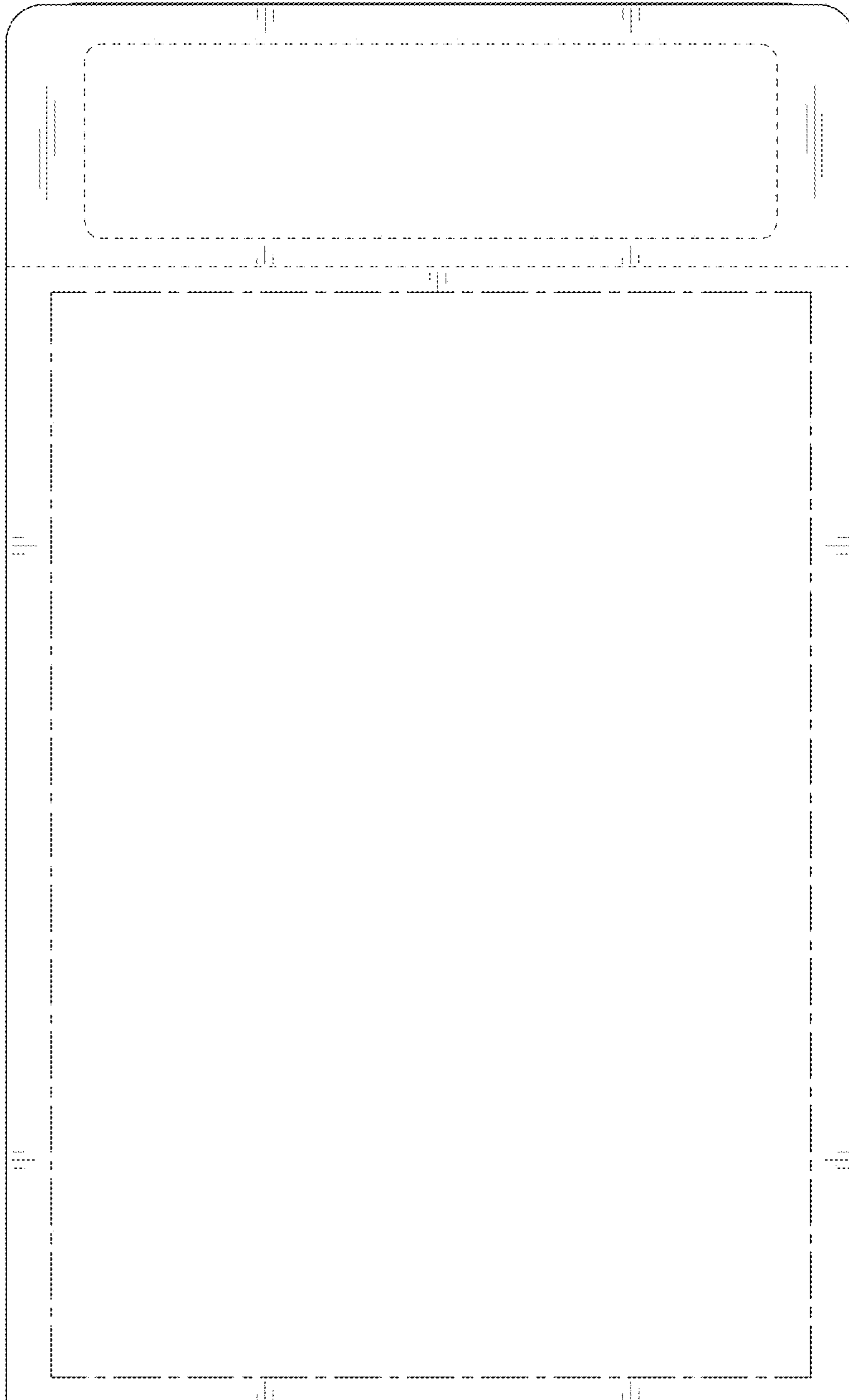

FIG. 4

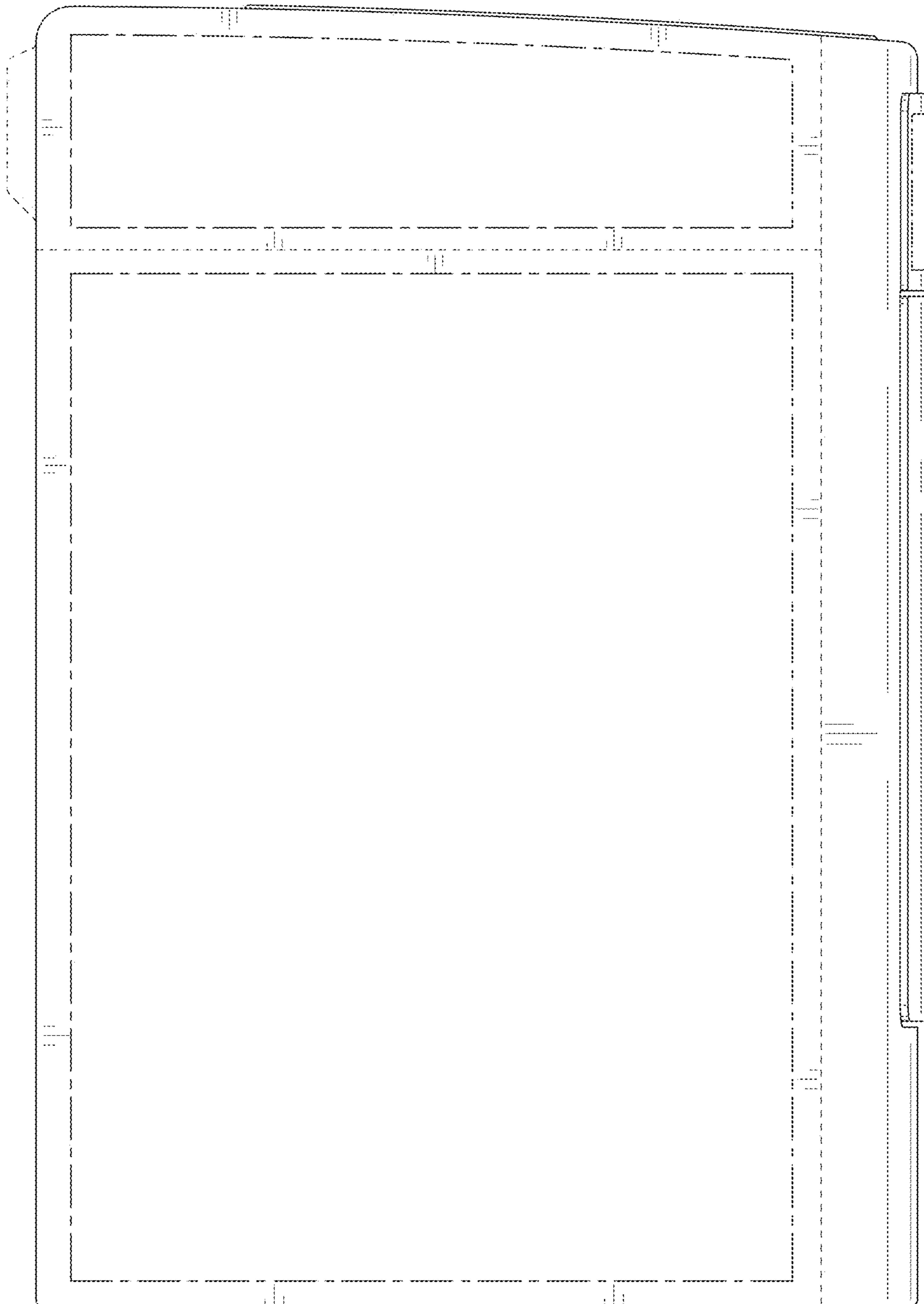

FIG. 5

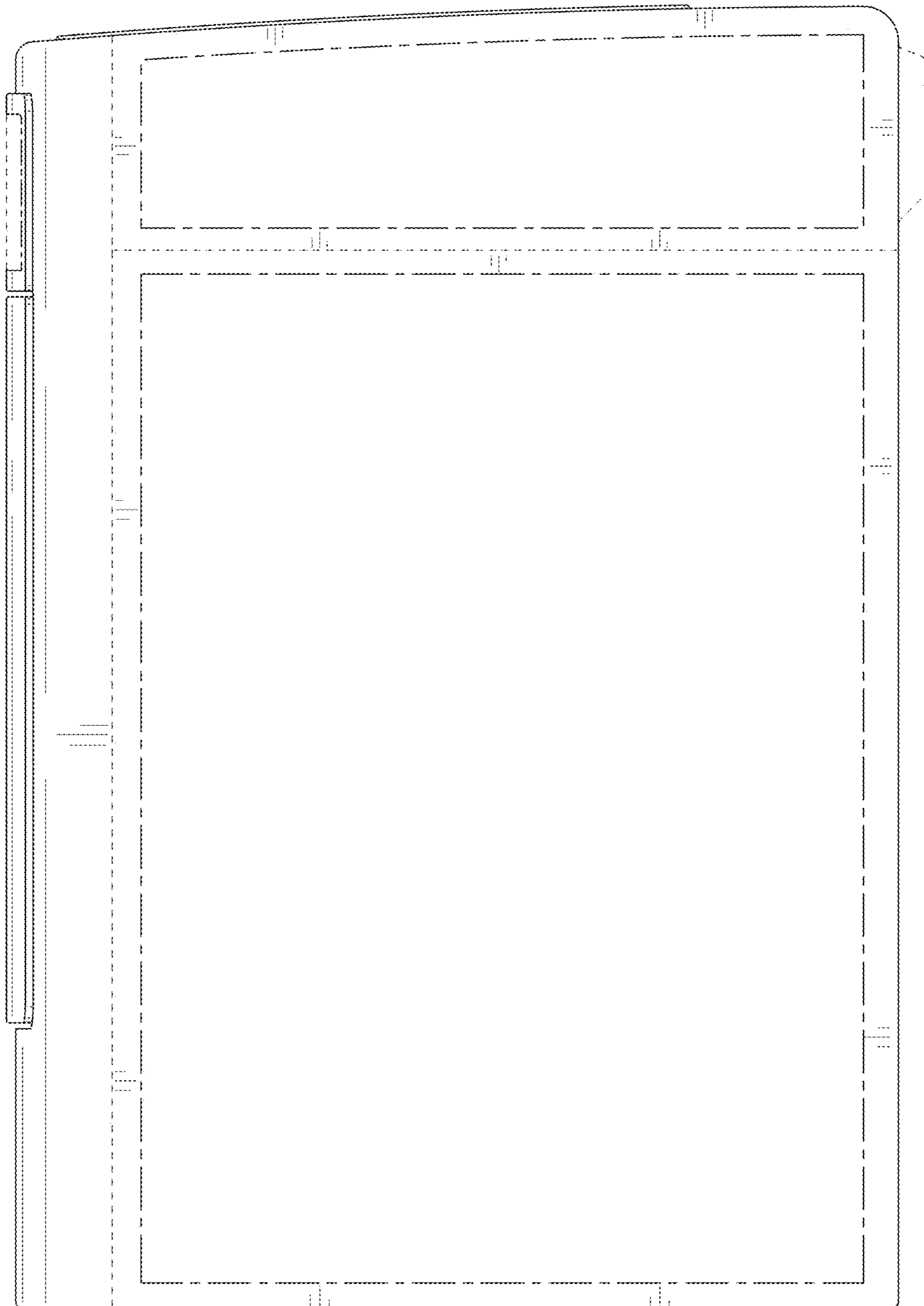

FIG. 6

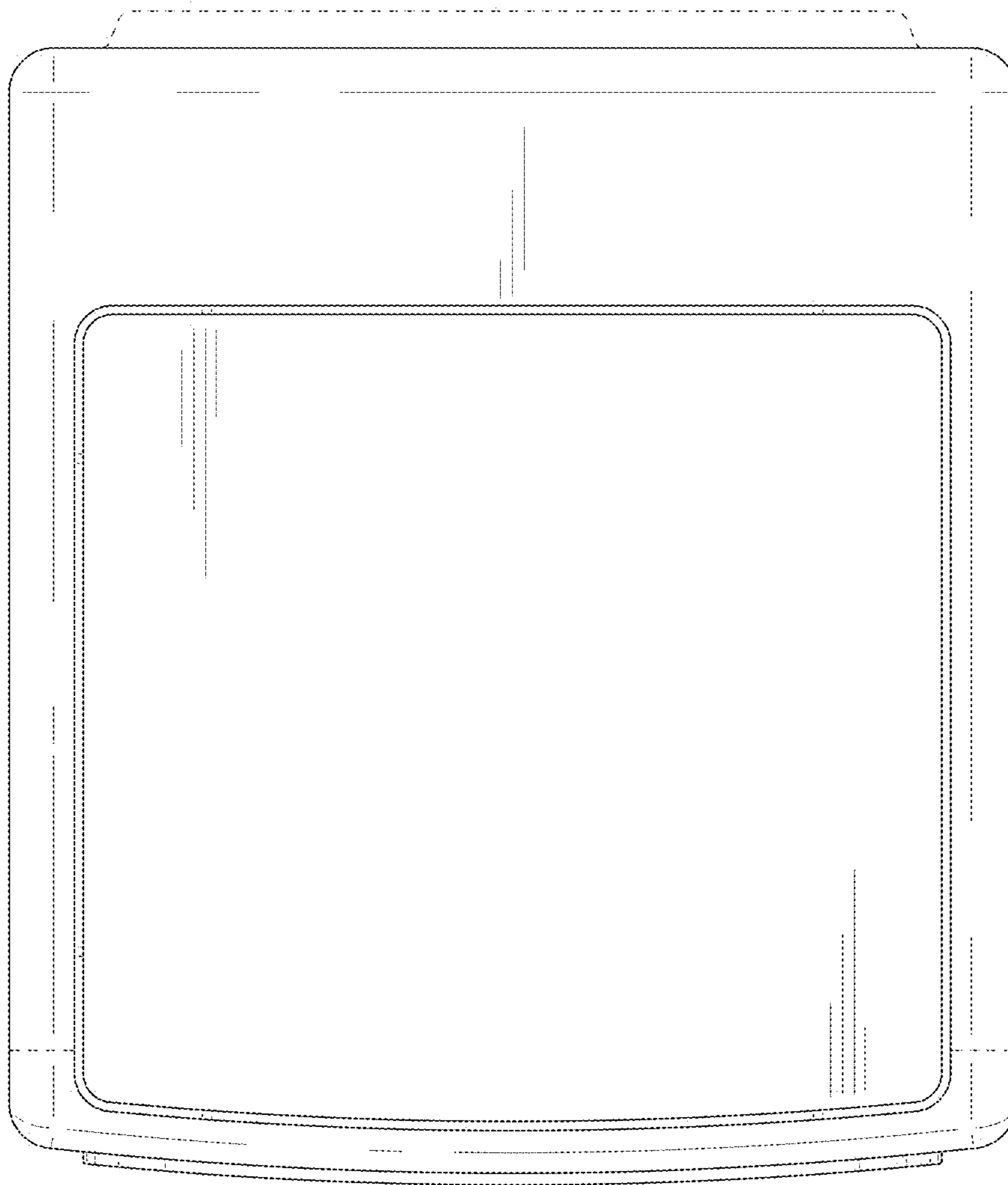

FIG. 7

