



US00D871324S

(12) **United States Design Patent**
Roberts

(10) **Patent No.:** **US D871,324 S**

(45) **Date of Patent:** **** Dec. 31, 2019**

(54) **PORTABLE POWER BANK**

(71) Applicant: **James Christopher Roberts**, St Martin (GB)

(72) Inventor: **James Christopher Roberts**, St Martin (GB)

(73) Assignee: **Flashbay Electronics Hong Kong Limited**, Hong Kong (HK)

(**) Term: **15 Years**

(21) Appl. No.: **29/635,607**

(22) Filed: **Feb. 1, 2018**

(51) **LOC (12) Cl.** **13-02**

(52) **U.S. Cl.**
USPC **D13/108**; D13/103

(58) **Field of Classification Search**
USPC D13/103, 107-108, 110, 118-119, 184, D13/199; D14/251, 253, 432, 434
CPC H02J 7/00; H02J 7/0003; H02J 7/0011; H02J 7/0013; H02J 7/025; H02J 7/0054; H02J 7/0055; H02J 7/0057; H02J 5/00; H02J 5/005; H02J 50/00; H02J 50/10; H02J 50/12; H02J 50/50; H02J 50/80; H01M 10/46; H01M 10/465; H01M 2200/30; H01M 2250/30

See application file for complete search history.

(56) **References Cited**

U.S. PATENT DOCUMENTS

D612,329 S * 3/2010 Guccione D13/108
D678,187 S * 3/2013 Huang D13/103

D705,719 S * 5/2014 Wong D13/103
D713,786 S * 9/2014 Wen D13/103
D717,243 S * 11/2014 Liu D13/103
D733,043 S * 6/2015 Hasbrook D13/103
D760,647 S * 7/2016 Chen D13/103
D787,443 S * 5/2017 Chiang D13/110
D814,405 S * 4/2018 Hahn D13/107
D816,607 S * 5/2018 Roberts D13/108
D826,854 S * 8/2018 Roberts D13/108
D827,569 S * 9/2018 Roberts D13/108
D828,295 S * 9/2018 Li D13/108
D839,823 S * 2/2019 Lemelson D13/103
D842,243 S * 3/2019 Qiu D13/108
D843,316 S * 3/2019 Zhou D13/108
D853,958 S * 7/2019 Lei D13/108

* cited by examiner

Primary Examiner — Rosemary K Tarcza

(57) **CLAIM**

The ornamental design for a portable power bank, as shown and described.

DESCRIPTION

FIG. 1 is a right side view of the portable power bank, showing my design.
FIG. 2 is a front view thereof.
FIG. 3 is a left side view thereof.
FIG. 4 is a rear view thereof.
FIG. 5 is a top view thereof, the bottom being the same.
FIG. 6 is a top rear left perspective thereof; and,
FIG. 7 is a top front right perspective thereof.

1 Claim, 2 Drawing Sheets

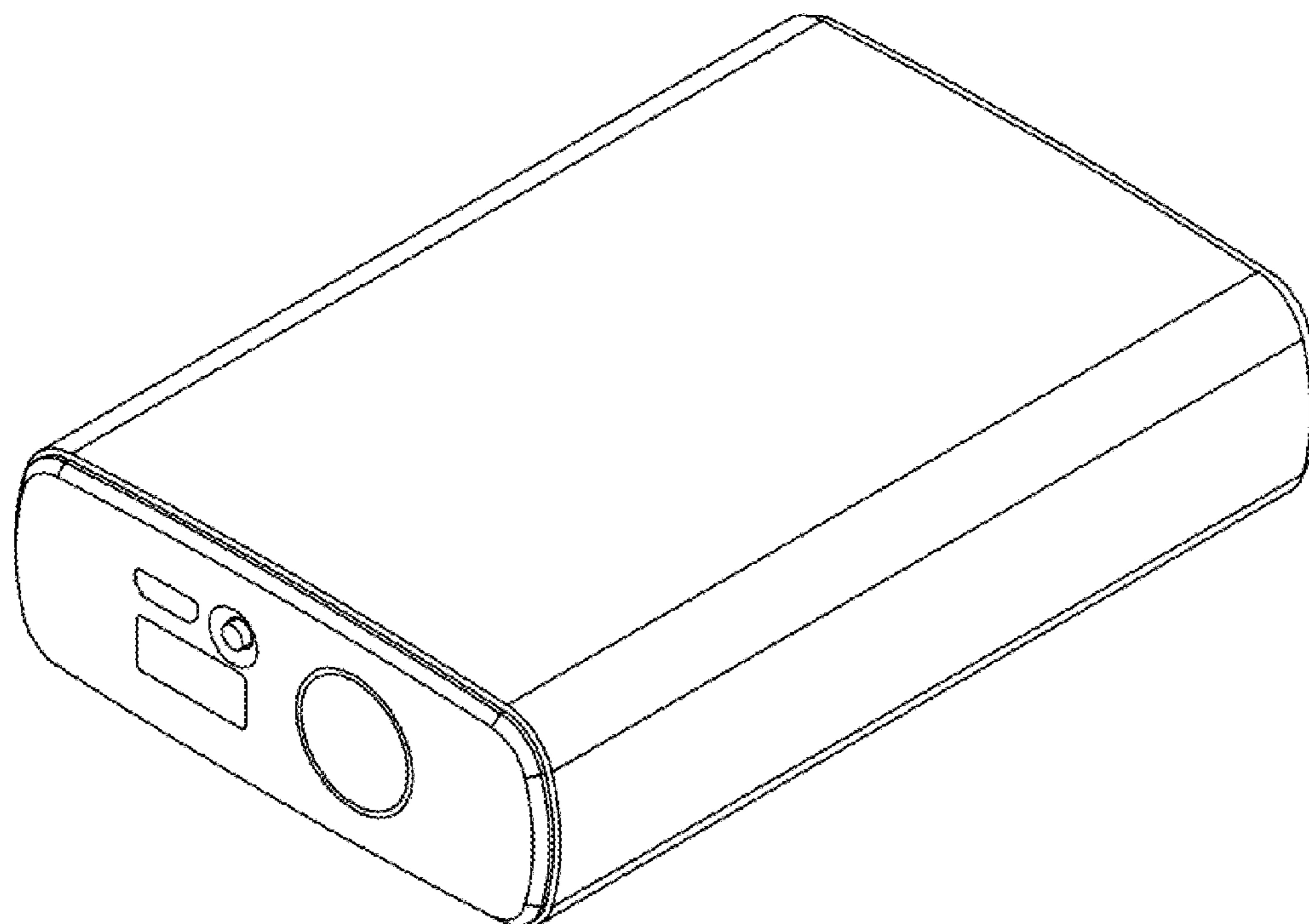

FIG.1

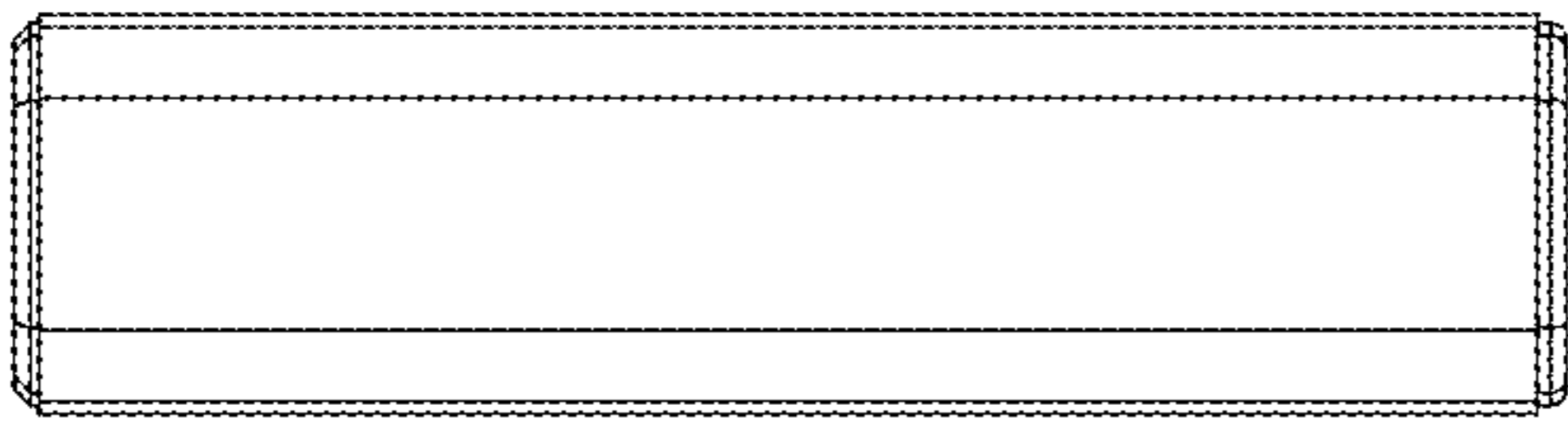

FIG.2

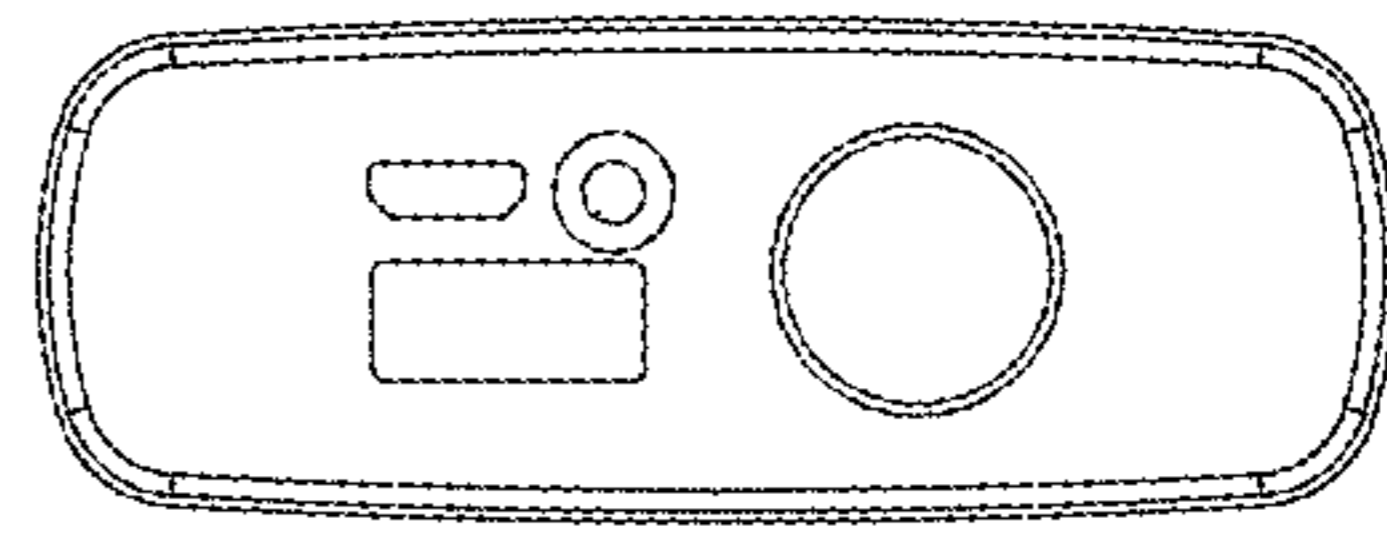

FIG.3

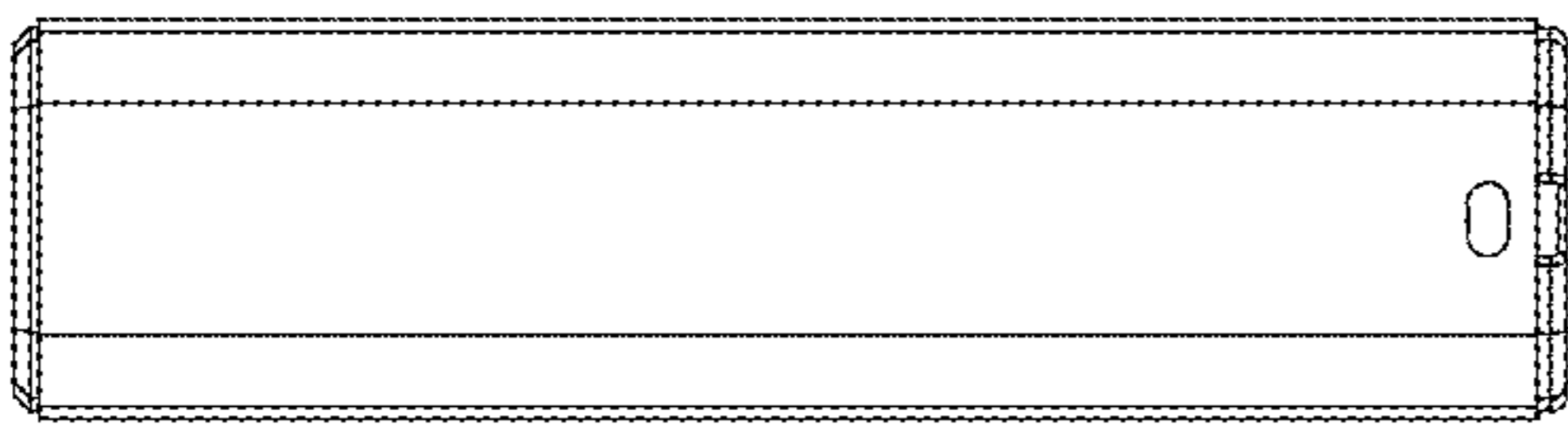

FIG.4

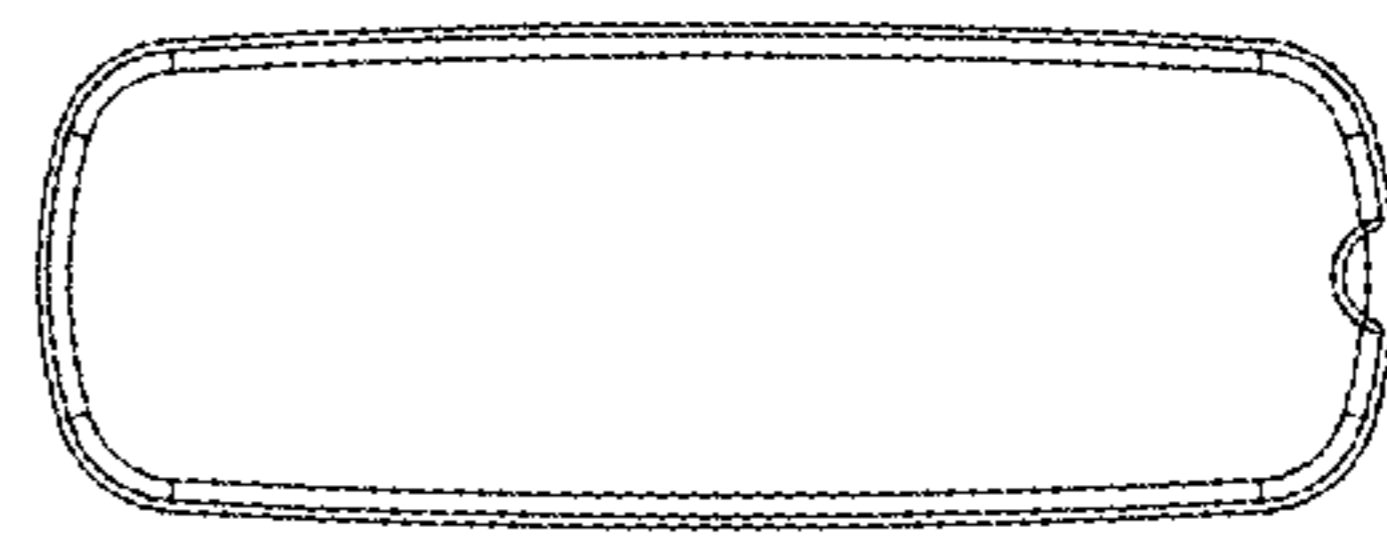

FIG.5

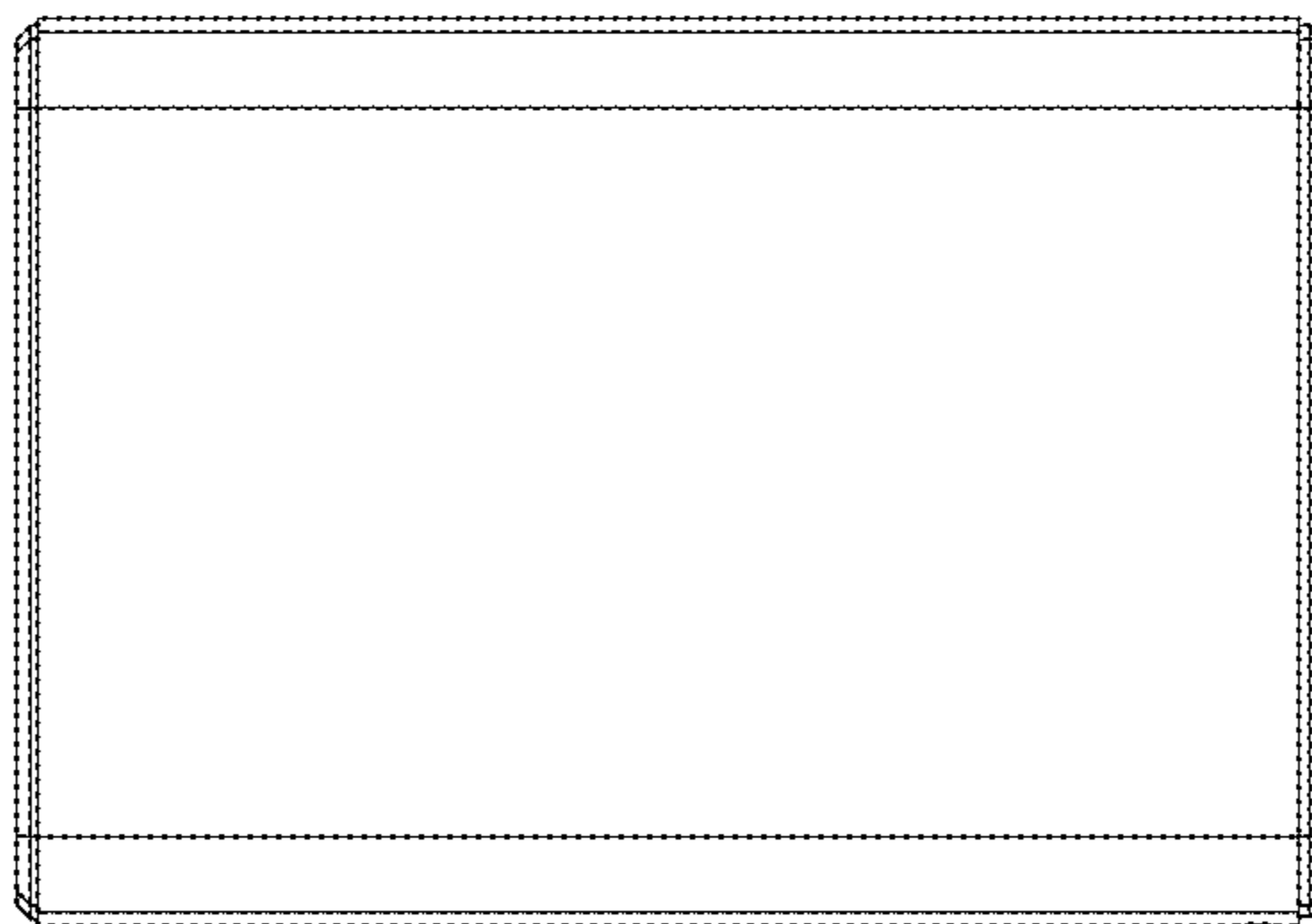

FIG.6

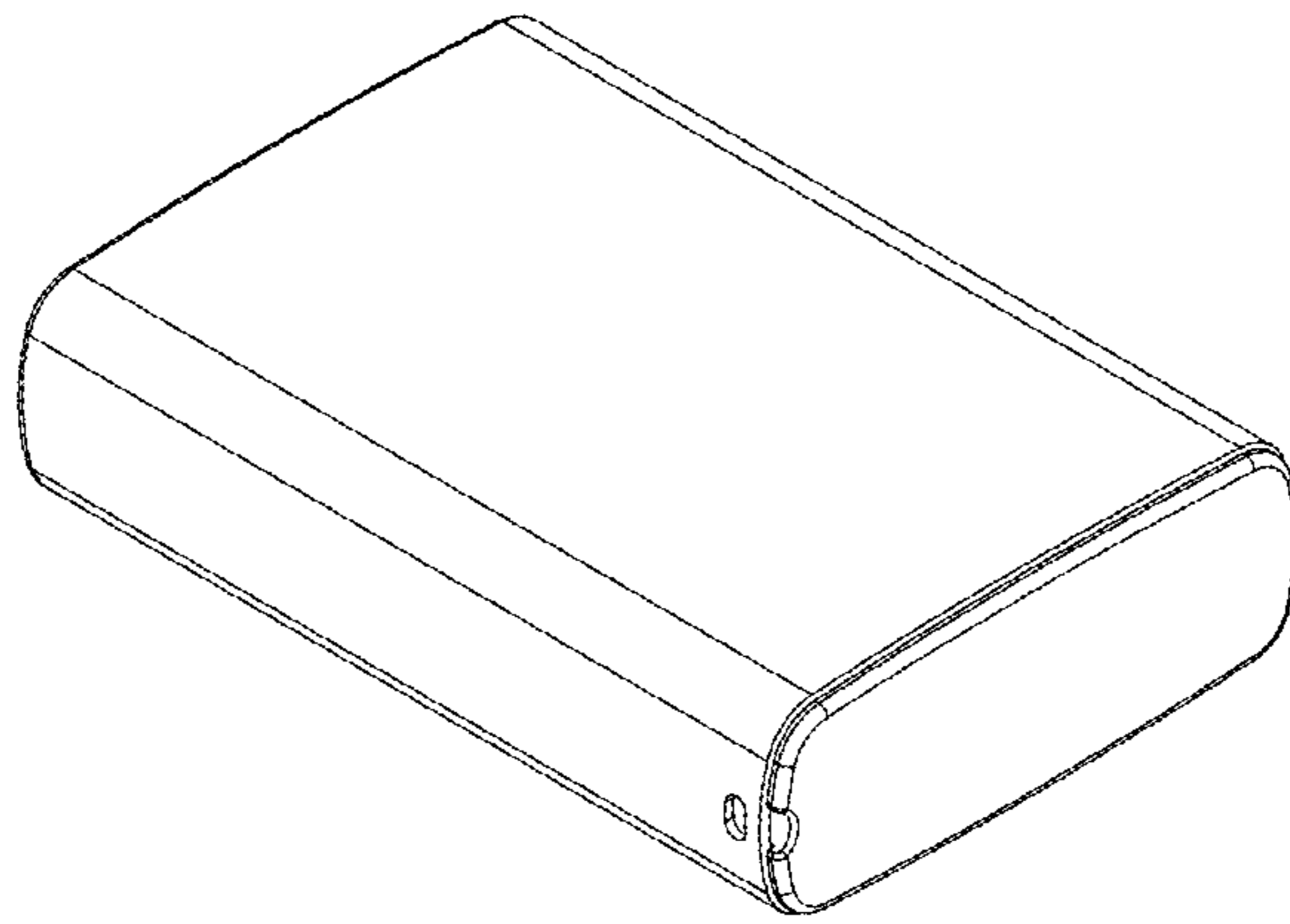

FIG.7

